

SECTION 10

Removing and Replacing Parts

- Preparing to Work Inside the Computer
- Recommended Tools
- Screw Identification
- System Components
- Replacing the Palm Rests
- Replacing the Display Cover
- Hard Drive Assembly
- Modular Bay Devices
- Memory Module
- Mini PCI Card Assembly
- Keyboard Assembly
- Removing the Display Assembly
- Display Assembly Latch
- Hinge Covers
- Palm Rest Assembly
- Microprocessor Thermal Cooling Assembly
- Microprocessor Module
- Reserve Battery

System Speaker
Assembly

System Board
Assembly

Module Latch
Assemblies

Preparing to Work Inside the Computer

 **NOTICE:** Only a certified service technician should perform repairs on your computer. Damage or inoperability due to servicing not authorized by Dell is not covered by your warranty.

 **NOTICE:** Unless otherwise noted, each procedure in this manual assumes that a part can be replaced by performing the removal procedure in reverse order.

 **NOTICE:** To avoid damaging the computer, perform the following steps before you begin working inside the computer.

- 1 Make sure that the work surface is clean to prevent scratching the computer cover.
- 2 Save and close any open files, and exit any open programs.
- 3 Turn off the computer and all attached devices.
- 4 Make sure the computer is undocked.
- 5 Disconnect the computer from the electrical outlet.
- 6 To avoid possible damage to the system board, wait 10 to 20 seconds and then disconnect any attached devices.
- 7 Disconnect all other external cables from the computer.
- 8 Remove any installed PC Cards or plastic blanks from the PC Card slot.
- 9 Close the display and turn the computer upside down on a flat work surface.
- 10 Remove the primary battery from the battery bay and the secondary battery from the modular bay, if a secondary battery is in use.
-  **NOTICE:** To avoid damaging the system board, you must remove the main battery and secondary battery (if present) before you service the computer.
- 11 Remove any installed device in the modular bay.
- 12 To dissipate any static electricity while you work, periodically touch an unpainted metal surface on the computer, such as the I/O panel on the back of the computer chassis.

 **HINT:** Make sure the computer is turned off and not in standby or hibernate mode. If you cannot shut down the computer using the computer's operating system, press and hold the power button for 4 seconds.

- 13 Handle components and cards with care. Do not touch the components or contacts on a card. Hold a card by its edges or by its metal mounting bracket. Hold a component such as a microprocessor by its edges, not by its pins.

Recommended Tools

The procedures in this manual require the following tools:

- #1 magnetized Phillips screwdriver
- Small flat-blade screwdriver
- Small plastic scribe
- Microprocessor extractor
- Flash BIOS update program floppy disk or CD (required only when upgrading the microprocessor, replacing the reserve battery, or replacing the system board)

Screw Identification

When you are removing and replacing components, photocopy the screw placemat as a tool to lay out and keep track of the component screws. The placemat provides the number of screws and the sizes.

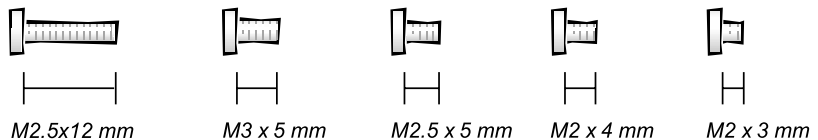

-  **NOTICE:** When reinstalling a screw, you must use a screw of the correct diameter and length. Make sure that the screw is properly aligned with its corresponding hole, and avoid over tightening.

Screw Placement

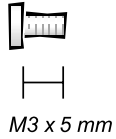
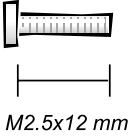
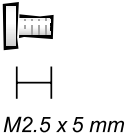
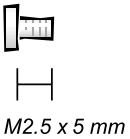
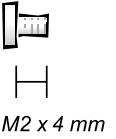
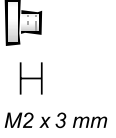
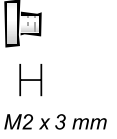
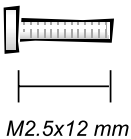
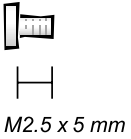
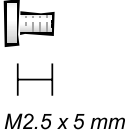
| | | |
|--|---|--|
| <p>Hard Drive Door Security: M3 x 5 (1 each)</p>  <p>M3 x 5 mm</p> | <p>Keyboard to Bottom Case Assembly: M2.5 x 12 (5 each)</p>  <p>M2.5x12 mm</p> | <p>LCD Display Bezel: M2.5 x 5 (4 each) Rubber Screw Covers (4 each)</p>  <p>M2.5 x 5 mm</p> |
| <p>LCD Hinge Bracket to Bottom Case Assembly: M2.5 x 5 (5 each)</p>  <p>M2.5 x 5 mm</p> | <p>14.1-Inch LCD Display Assembly and Flex-Cable Retention Bracket to Top Cover: M2 x 4 (5 each)</p>  <p>M2 x 4 mm</p> | <p>Display Assembly EMI Shield Bracket: M2 x 3 (5 each)</p>  <p>M2 x 3 mm</p> |
| <p>Palm Rest to Bottom Case Assembly: M2 x 3 (5 each) M2.5 x 12 (3 each)</p>   <p>M2 x 3 mm M2.5x12 mm</p> | <p>Hybrid Cooling Fan: M2.5 x 5 (2 each)</p>  <p>M2.5 x 5 mm</p> | <p>System Board to Bottom Case Assembly: M2.5 x 5 (10 each)</p>  <p>M2.5 x 5 mm</p> |

System Components



Replacing the Palm Rests

- 1 Save and close any open files, exit any open programs, and shut down the computer.
- 2 If the computer is connected (docked) to an advanced port replicator (APR), undock it.
- 3 Keep the display open and tilt the computer back so that you can access the bottom of the computer.
- 4 Slide and hold the latch release on the left side, and remove any device installed in the modular bay.
- 5 Slide and hold the latch release on the right side, and remove any battery installed in the battery bay.
- 6 Locate the orange palm rest removal buttons. Firmly press the buttons with the eraser end of a pencil (or a dull utensil smaller than your finger) to release the palm rests.

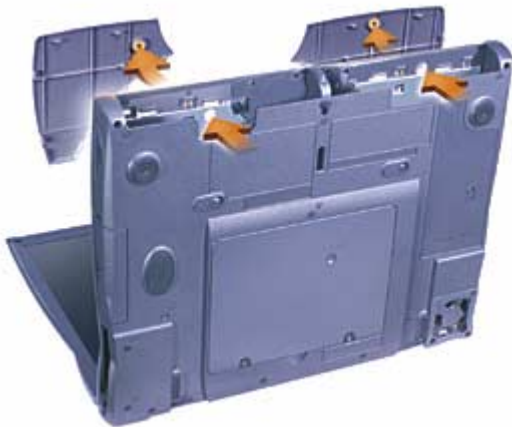

- 7 Remove the palm rests.
- 8 To replace the palm rests, insert the tabs on the inside edge of the palm rest into the slots on the computer. Then press along the outside edges of the palm rest until it snaps into place.

Repeat the process on each side.



Replacing the Display Cover

- 1 Slide your index fingers under the straight edge of the display cover until the cover pops out.
- 2 Slide the display cover towards the back of the computer.



- 3 Use your fingers to release the cover completely, and remove it.
- 4 To replace the display cover, bend it slightly to insert the four tabs on the rounded edge of the cover into the slots on the top of the computer.
- 5 Press the cover along the straight edge at the back of the computer until it snaps into place.
- 6 Firmly press the Dell logo until it snaps into place. Press above both hinge covers to engage the final snaps.

Hard Drive Assembly

- ➔ **NOTICE:** The hard drive is very sensitive to shock. Handle the assembly by its edges (do not squeeze the top of the hard drive case), and avoid dropping it.

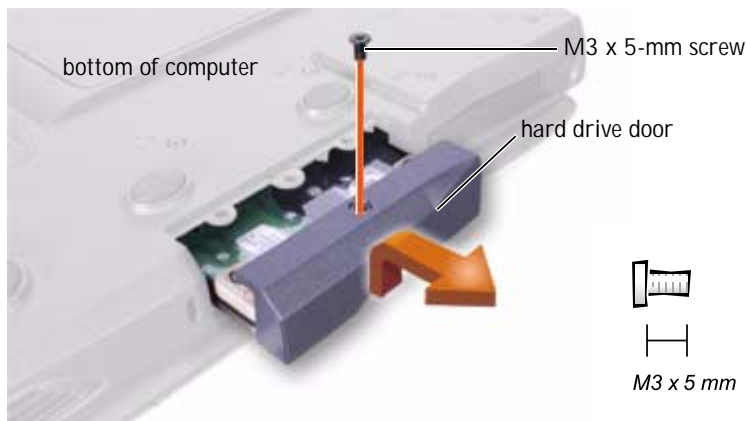

Removing the Hard Drive Assembly

- ➔ **NOTICE:** Disconnect the computer and any attached devices from electrical outlets, and remove any installed batteries.
- ➔ **NOTICE:** To avoid ESD, ground yourself by using a wrist grounding strap or by touching an unpainted metal surface on the computer.
- ➔ **NOTICE:** Read "[Preparing to Work Inside the Computer](#)" before performing the following procedure.
- 1 Remove the screw from the hard drive door.

- 2 Slide the drive door up until the drive assembly tabs disengage from the door slots in the bottom case assembly.
- 3 Pull the drive assembly straight out of the bottom case assembly.

Replacing the Hard Drive Assembly

- 1 Push the drive assembly into the hard drive opening of the computer.
- 2 Align the drive assembly tabs with the bottom case assembly slots and push down until it clicks into place.
- 3 Replace the screw in the drive door.

Modular Bay Devices

- ➡ **NOTICE:** Disconnect the computer and any attached devices from electrical outlets, and remove any installed batteries.
 - ➡ **NOTICE:** To avoid ESD, ground yourself by using a wrist grounding strap or by touching an unpainted metal surface on the computer.
 - ➡ **NOTICE:** Read "[Preparing to Work Inside the Computer](#)" before performing the following procedure.
- 1 Close the display, and turn the computer upside down on a flat work surface.
 - 2 Slide the modular bay latch toward the right.
 - 3 Keep holding the latch open while you pull the device out of the modular bay with the other hand.

Memory Module

- ➡ **NOTICE:** The only time you should ever access the inside of your computer is when you are installing memory modules or a Mini PCI card.



Removing the Memory Module Cover

- ➔ **NOTICE:** Disconnect the computer and any attached devices from electrical outlets, and remove any installed batteries.
- ➔ **NOTICE:** To avoid ESD, ground yourself by using a wrist grounding strap or by touching an unpainted metal surface on the computer.
- ➔ **NOTICE:** Read “[Preparing to Work Inside the Computer](#)” before performing the following procedure.

1 Remove the memory module cover:

- a Use a coin or flat-blade screwdriver to release the two captive screws that secure the memory module cover.
- b Place your finger under the cover at the indentation and lift and slide the cover open.

 **HINT:** The screw labeled with the “circle K” in the middle of the memory module cover secures the keyboard assembly and does not secure the memory module cover.

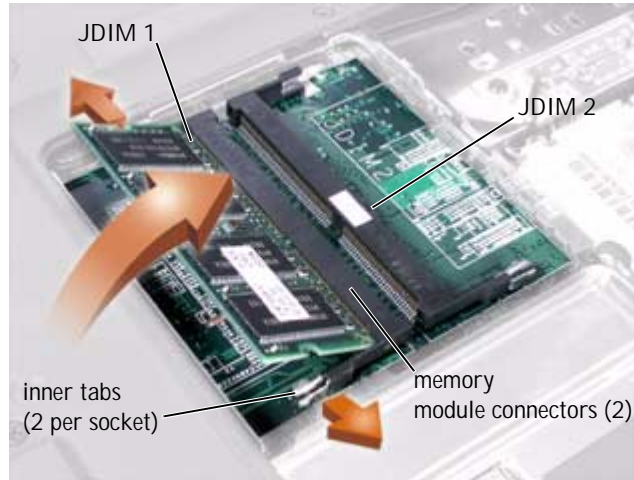

Removing the Memory Modules

- ➡ **NOTICE:** Disconnect the computer and any attached devices from electrical outlets, and remove any installed batteries.
- ➡ **NOTICE:** To avoid ESD, ground yourself by using a wrist grounding strap or by touching an unpainted metal surface on the computer.
- ➡ **NOTICE:** Read “[Preparing to Work Inside the Computer](#)” before performing the following procedure.

1 Remove the [memory module cover](#).

- ➡ **NOTICE:** Handle memory modules with care. Do not touch the components on a module. Hold the module by its edges.
- 2 To release a memory module from its connector, spread apart the inner tabs of the memory module connector just far enough for the memory module to disengage from the connector. The module should pop up slightly.
 - 3 Lift the memory module out of its connector.

Replacing the Memory Modules

- 1 If you only have one memory module, install it in the connector labeled “JDIM1.” If you have two memory modules, install the second module in the connector labeled “JDIM2.”

- 2 Align the memory module's edge connector with the slot in the center of the memory module connector. With the module at a 45-degree angle, press the memory module's edge connector firmly into the memory module connector.
- 3 Pivot the memory module down until it clicks into place. If you do not hear a click, remove the memory module and reinstall it.
- 4 Insert the tabs on the memory module cover into the bottom case assembly. Rotate the memory module cover down and tighten the two captive screws.

 **HINT:** Memory modules are keyed, or designed to fit into their connectors, in only one direction.

Mini PCI Card Assembly

 **NOTICE:** The only time you should ever access the inside of your computer is when you are installing memory modules or a Mini PCI card.

The optional Mini PCI card assembly may contain either a modem, network adapter, or combination of both. You must remove the Mini PCI card subassembly before the system board assembly can be removed. The Mini PCI card subassembly must be connected to the internal antenna for proper operation.

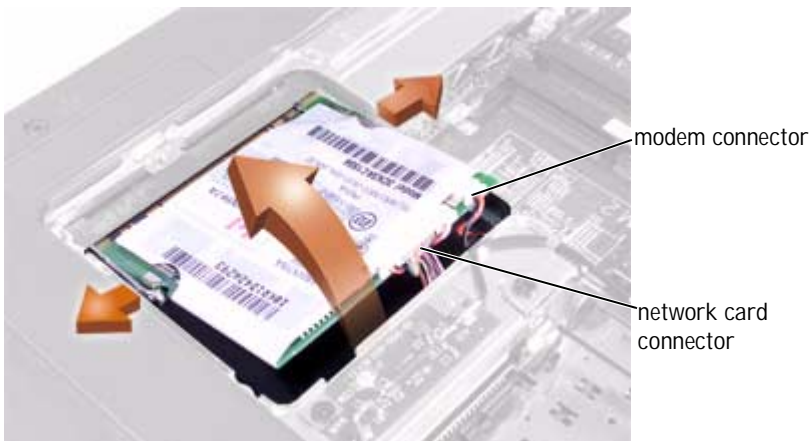

Removing the Mini PCI Card Assembly

 **NOTICE:** Disconnect the computer and any attached devices from electrical outlets, and remove any installed batteries.

- ➡ **NOTICE:** To avoid ESD, ground yourself by using a wrist grounding strap or by touching an unpainted metal surface on the computer.
- ➡ **NOTICE:** Read “[Preparing to Work Inside the Computer](#)” before performing the following procedure.

- 1 Remove the [memory module cover](#).
- 2 To release a Mini PCI card subassembly from its connector, spread apart the inner tabs of the connector just far enough for the Mini PCI card assembly to disengage from the connector. The module should pop up slightly from the interface connector.
- 3 Lift the Mini PCI card subassembly out of its connector and disconnect any attached cables.

Replacing the Mini PCI Card Assembly

- 1 Align and press the Mini PCI card subassembly into the system board interface connector.
- 2 Connect the interface cables.
- 3 Replace the memory module cover.

 **HINT:** A modem-only Mini PCI card has only one cable and connector.

Keyboard Assembly

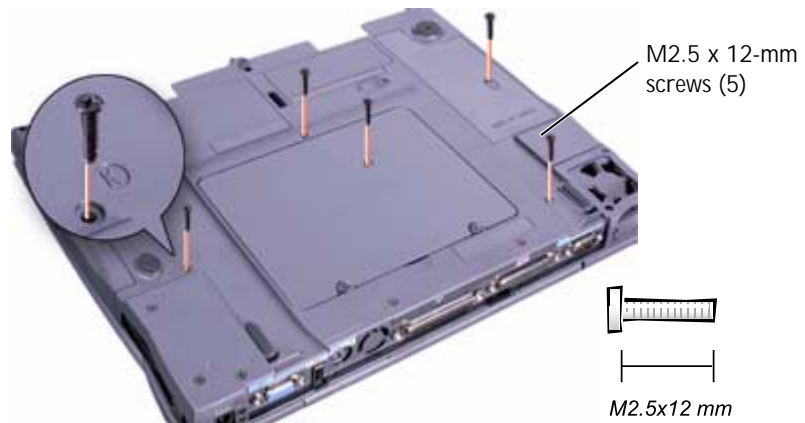

Removing the Keyboard Assembly

- ➔ **NOTICE:** Disconnect the computer and any attached devices from electrical outlets, and remove any installed batteries.
 - ➔ **NOTICE:** To avoid ESD, ground yourself by using a wrist grounding strap or by touching an unpainted metal surface on the computer.
 - ➔ **NOTICE:** Read “[Preparing to Work Inside the Computer](#)” before performing the following procedure.
- 1 Remove the [hard drive assembly](#).
 - 2 Turn the computer bottom-side up, and remove the five screws labeled with a “circle K.”
 - 3 Turn the computer right-side up and open the display.
- ➔ **NOTICE:** The key caps on the keyboard are fragile, easily dislodged, and time-consuming to replace. Be careful when removing and handling the keyboard.
- 4 Insert a small, flat-blade screwdriver or plastic scribe into the scalloped edge next to the right < Shift > key, and release the keyboard from the palm rest assembly.



- 5 Lift the keyboard straight up until it clears the keyboard boss support in the bottom case assembly.
- 6 Rotate the keyboard forward toward the front of the computer.
- 7 Rest the key face of the keyboard on the palm rest.

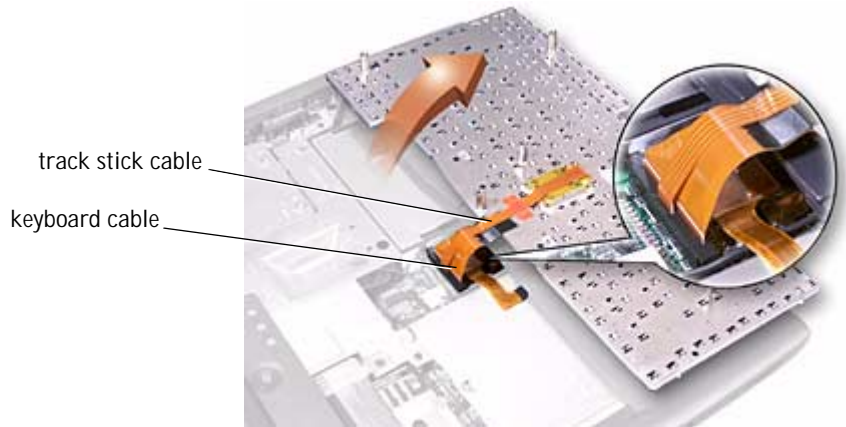

- 8 Disconnect the keyboard flex cable from the interface connector on the system board assembly by pulling up on the connector.
- 9 Remove the keyboard assembly from the bottom case assembly.

Replacing the Keyboard Assembly

- 1 Place the keyboard on the palm rest at the front of the computer with the keys facing down and the connector toward the back of the computer.
- 2 Connect the keyboard flex cable to the interface connector on the system board assembly.
- ➡ **NOTICE:** Position the keyboard cable so that it does not pinch when you replace the keyboard in the bottom case assembly.
- 3 Carefully turn the keyboard over and fit the keyboard into place.
- 4 Check that the keyboard is correctly installed. The keys should be flush with the left and right surfaces of the palm rest.
- ➡ **NOTICE:** Make sure that the keyboard is aligned correctly to avoid stripping the screws the next time they are removed.
- 5 Reinstall the five M2.5 x 12-mm screws in the holes labeled “circle K.”
- ➡ **NOTICE:** You must remove the display assembly before you remove the palm rest assembly; the display assembly hinges pass through the back of the palm rest assembly.

Removing the Display Assembly

- ➔ **NOTICE:** Disconnect the computer and any attached devices from electrical outlets, and remove any installed batteries.
- ➔ **NOTICE:** To avoid ESD, ground yourself by using a wrist grounding strap or by touching an unpainted metal surface on the computer.
- ➔ **NOTICE:** Read “[Preparing to Work Inside the Computer](#)” before performing the following procedure.

 **HINT:** Always remove and replace the LCD panel as a complete assembly.

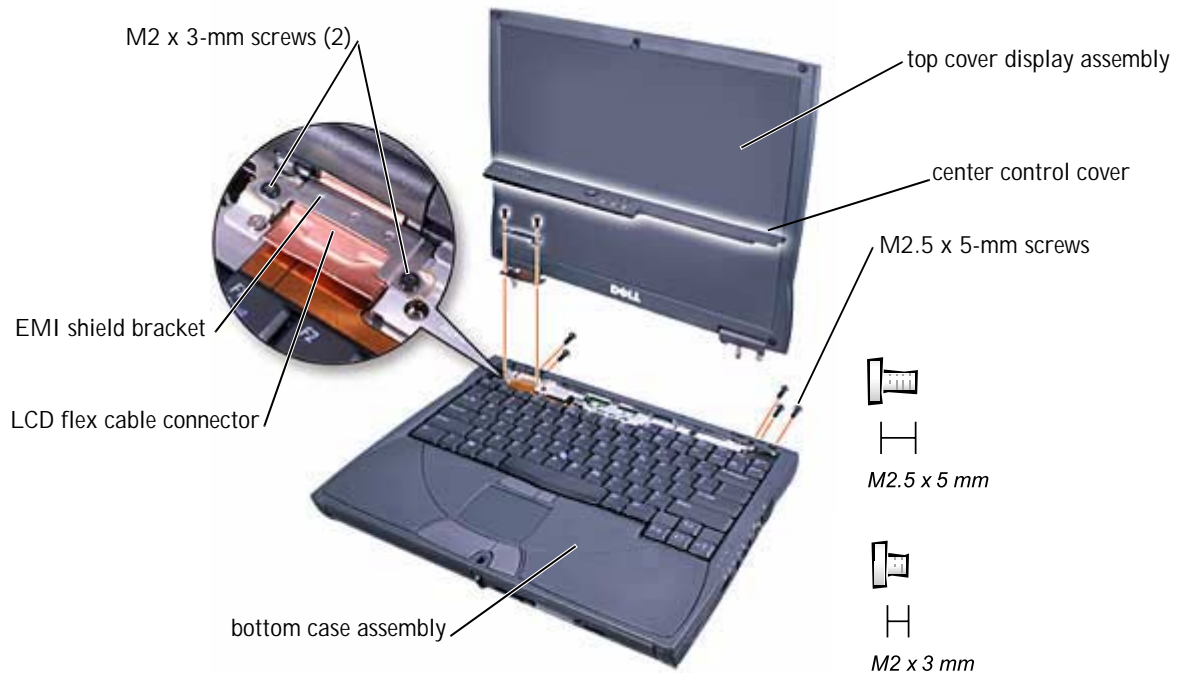

- 1 Remove the [hard drive assembly](#).
- 2 Remove the center control cover:
 - a Use a scribe to lift the right edge of the center control cover and pry it loose from the bottom case assembly.

- b Lift the center control cover up and away from the bottom case assembly.
- 3 Close the display. From the back of the computer, remove the five screws labeled with the “circle D.” There are two screws on the right hinge and three screws on the left hinge.
- 4 Open the display assembly approximately 90 degrees, and support the display assembly so that it does not open past this position.
- 5 Remove the two M2 x 3-mm screws that secure the EMI shield bracket (metal) to the system board assembly.
- 6 Remove the flex cable EMI shield retention bracket that covers the display flex cable connector on the system board.
- 7 Pull straight up on the loop attached to the interface cable connector to disconnect the display flex cable from the system board.
- 8 Lift the display assembly from the bottom case assembly.
- 9 Remove the right and left plastic hinge covers from the hinges.

 **HINT:** The right plastic hinge cover is labeled “R” and the left plastic hinge cover is labeled “L.”

 **NOTICE:** When reconnecting the display-feed cable connector to the system board, push down on the top left and right ends of the connector. Pressing on the center of the connector might damage resistors and compromise EMI protection in the computer.



Removing the 14.1-Inch Display Assembly Bezel

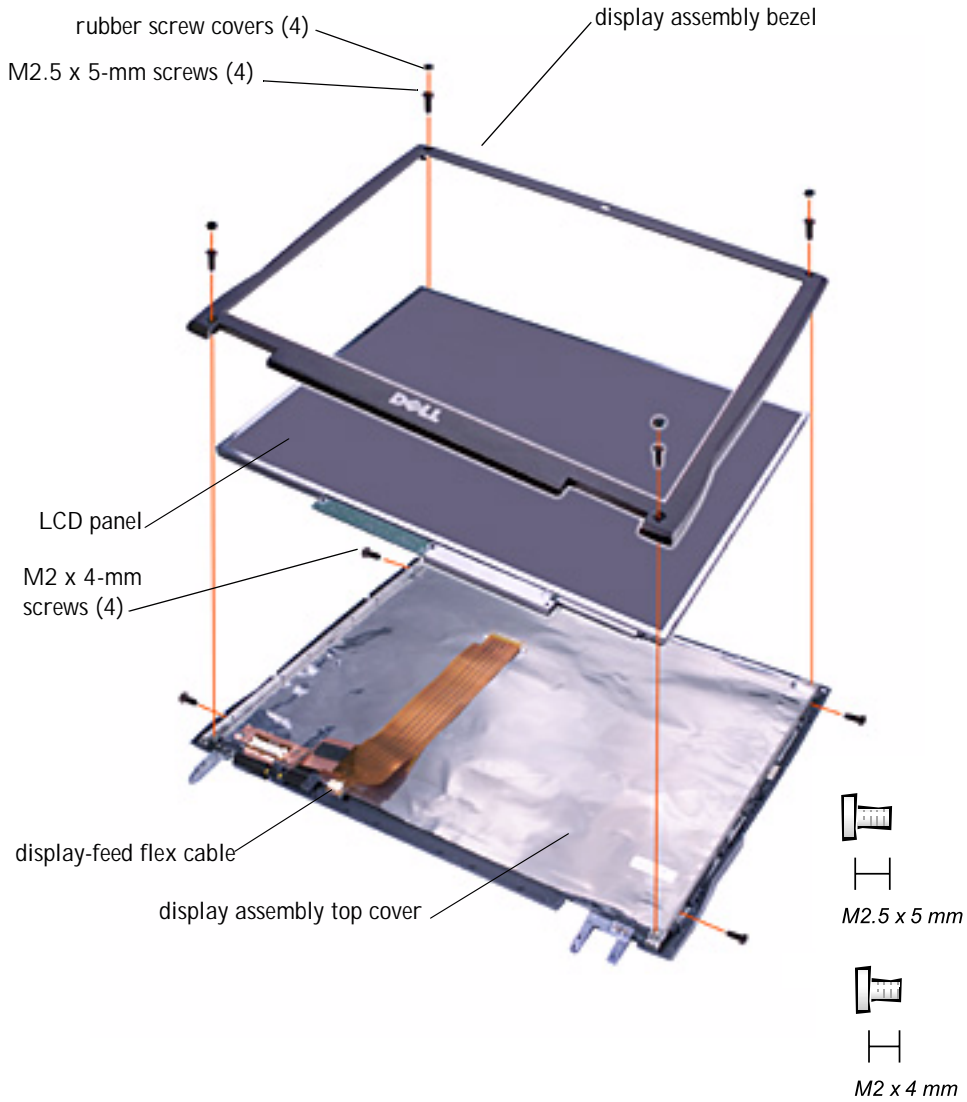

NOTICE: Disconnect the computer and any attached devices from electrical outlets, and remove any installed batteries.

- ➔ **NOTICE:** To avoid ESD, ground yourself by using a wrist grounding strap or by touching an unpainted metal surface on the computer.
- ➔ **NOTICE:** Read “[Preparing to Work Inside the Computer](#)” before performing the following procedure.
 - 1 Remove the [hard drive assembly](#).
 - 2 Remove the [display assembly](#).
 - 3 Use the scribe to pry the four rubber screw covers out of the screw holes located at the four corners of the bezel on the front of the display assembly.
 - 4 Remove the four M2.5 x 5-mm screws located at the corners of the bezel on the front of the display assembly.
- ➔ **NOTICE:** Some of the bezel snaps may be difficult to remove, so be careful when separating the bezel from the display assembly.
 - 5 Use a plastic scribe and separate the bezel from the display-assembly top cover.
 - 6 Be careful not to lose the display magnet on the right side of the back cover. The polarity of the magnet is marked with a minus “-” sign and oriented toward the bottom of the display. Make sure to replace the magnet in the same orientation when you reassemble the display.

Removing the 14.1-Inch LCD Panel

- ➔ **NOTICE:** Disconnect the computer and any attached devices from electrical outlets, and remove any installed batteries.
- ➔ **NOTICE:** To avoid ESD, ground yourself by using a wrist grounding strap or by touching an unpainted metal surface on the computer.
- ➔ **NOTICE:** Read “[Preparing to Work Inside the Computer](#)” before performing the following procedure.
 - 1 Remove the [hard drive assembly](#).
 - 2 Remove the [display assembly](#).
 - 3 Remove the [display assembly bezel](#).
 - 4 Remove the two M2 x 4-mm screws on the left side of the LCD panel and the two M2 x 4-mm screws on the right side of the LCD panel.

- 5 Remove the M2 x 4-mm screw that secures the display flex cable to the display assembly through the flex-cable retention bracket (black plastic).
- 6 Lift and rotate the top of the LCD panel out of the top cover.



Replacing the 14.1-Inch LCD Panel

- 1 Place the bottom edge of the LCD panel in the bottom of the top cover, and elevate the top of the panel with your hand.
- 2 Lay the LCD panel in the top cover.
- 3 Reinstall the five M2 x 4-mm screws securing the LCD panel to the top cover.

 **HINT:** Use a magnetic screwdriver to reassemble the LCD panel in the display, and secure the right side first. Make sure to replace the magnet with the minus sign toward the bottom of the display.

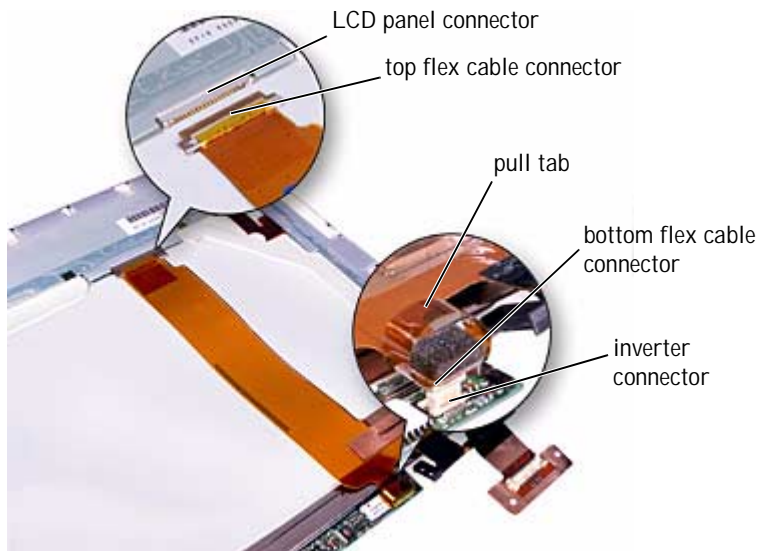
Removing the Display-Feed Flex Cable



-  **NOTICE:** Disconnect the computer and any attached devices from electrical outlets, and remove any installed batteries.
-  **NOTICE:** To avoid ESD, ground yourself by using a wrist grounding strap or by touching an unpainted metal surface on the computer.
-  **NOTICE:** Read "[Preparing to Work Inside the Computer](#)" before performing the following procedure.

- 1 Remove the [hard drive assembly](#).
- 2 Remove the [display assembly](#).
- 3 Remove the [display assembly bezel](#).
- 4 Remove the tape that covers the connector to the LCD panel located at the top of the display-feed flex cable.
- 5 Hold the connector at the top of the display-feed flex cable, and pull down and away to remove it from the LCD panel.

Display Assembly Latch

- ➔ **NOTICE:** Disconnect the computer and any attached devices from electrical outlets, and remove any installed batteries.
- ➔ **NOTICE:** To avoid ESD, ground yourself by using a wrist grounding strap or by touching an unpainted metal surface on the computer.
- ➔ **NOTICE:** Read "[Preparing to Work Inside the Computer](#)" before performing the following procedure.

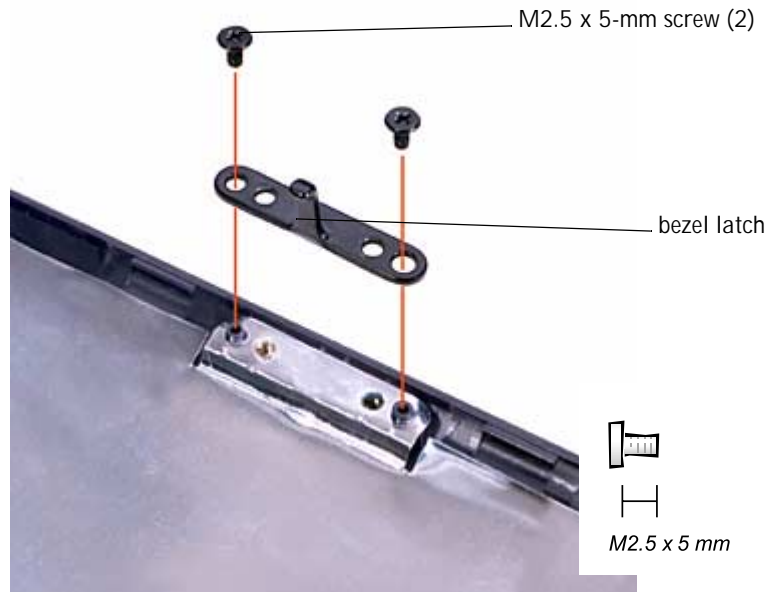

- 1 Remove the [hard drive assembly](#).
- 2 Remove the [display assembly](#).
- 3 Remove the [display assembly bezel](#).
- 4 Remove the display assembly bezel latch by removing the two M2.5 x 5-mm screws that secure it to the display assembly top cover.

Hinge Covers

Removing the Hinge Covers



- 1 Remove the [display assembly](#).
- 2 Remove the plastic hinge covers from the hinges.

Replacing the Hinge Covers

- 1 Attach the display assembly to the bottom case assembly.
- 2 Close the display assembly and snap the hinge covers in place over the hinges.

 **HINT:** The right hinge cover is labeled “R,” and the left hinge cover is labeled “L.” The labels face the back of the computer.



Palm Rest Assembly

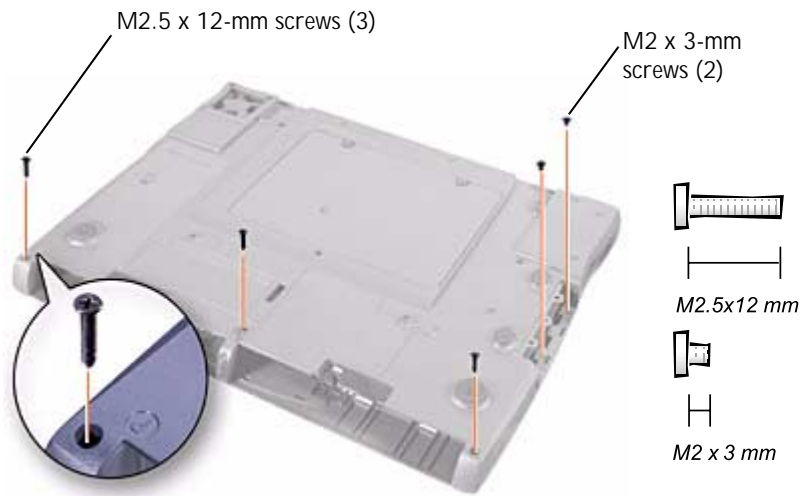

Removing the Palm Rest Assembly

- ➔ **NOTICE:** Disconnect the computer and any attached devices from electrical outlets, and remove any installed batteries.
 - ➔ **NOTICE:** To avoid ESD, ground yourself by using a wrist grounding strap or by touching an unpainted metal surface on the computer.
 - ➔ **NOTICE:** Read “[Preparing to Work Inside the Computer](#)” before performing the following procedure.
- 1 Remove the [hard drive assembly](#).
 - 2 Remove the [keyboard](#).
- ➔ **NOTICE:** You must remove the display assembly before you remove the palm rest assembly; the display assembly hinges pass through the back of the palm rest assembly.
- 3 Turn the computer right-side up on the work surface, and remove the display [hinge cover](#) and [display assembly](#).
 - 4 Turn the computer over and remove the three M2.5 x 12-mm screws labeled with a “circle P.”
 - 5 Remove the five M2 x 3-mm screws that secure the palm rest to the bottom case assembly:

- a Remove the two M2 x 3-mm screws located in the hard drive bay door and labeled with a “circle P.”
 - b Remove the remaining two M2 x 3-mm screws located on the back edge of the bottom case assembly, underneath the display assembly.
 - c Turn the bottom case assembly over. Remove the M2 x 3-mm screw located underneath the keyboard, on the right side of the bottom case assembly, next to the microprocessor thermal cooling assembly.
- 6 Pull up on the loop attached to the palm rest flex cable to remove it from the interface connector on the system board assembly.

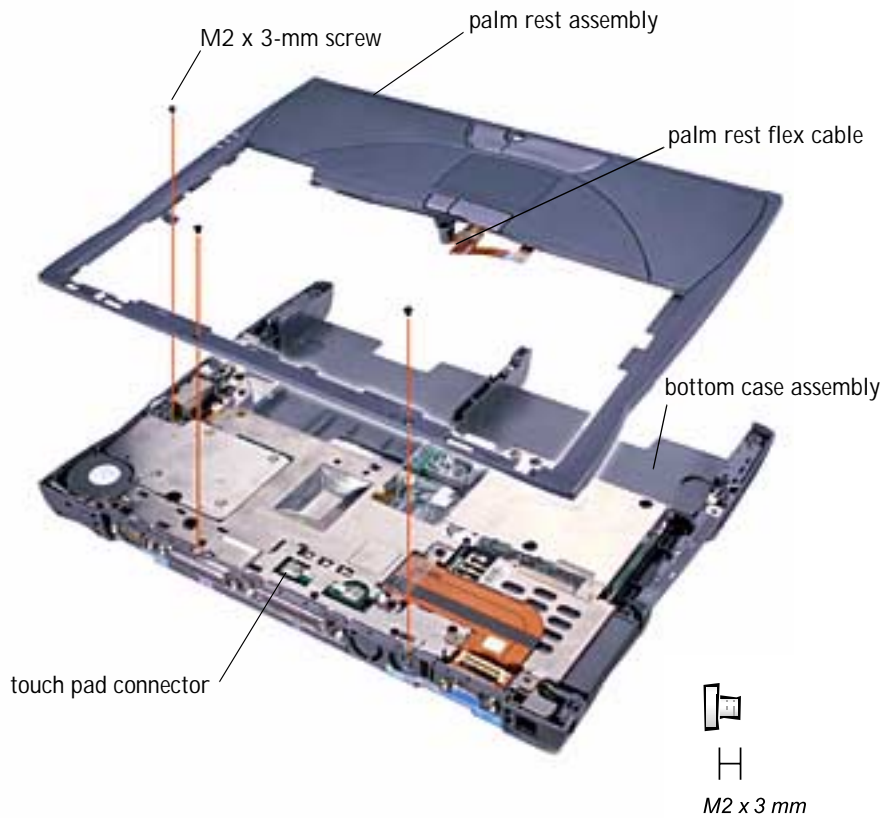

- 7 Using the plastic scribe along the edge of the plastic, remove the palm rest assembly from the bottom case assembly.

Microprocessor Thermal Cooling Assembly

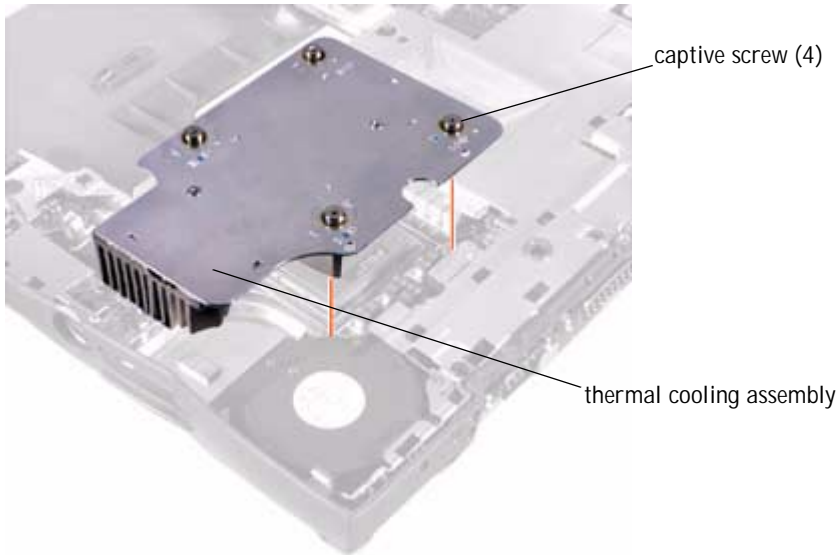

Removing the Microprocessor Thermal Cooling Assembly

- ➔ **NOTICE:** Disconnect the computer and any attached devices from electrical outlets, and remove any installed batteries.
 - ➔ **NOTICE:** To avoid ESD, ground yourself by using a wrist grounding strap or by touching an unpainted metal surface on the computer.
 - ➔ **NOTICE:** Read “[Preparing to Work Inside the Computer](#)” before performing the following procedure.
- 1 Remove the [hard drive assembly](#).
 - 2 Turn the computer over and remove the [keyboard assembly](#).
 - 3 Remove the [display assembly](#).

- 4 Loosen the four captive screws securing the microprocessor thermal cooling assembly.
- 5 Remove the microprocessor thermal cooling assembly from the system board assembly.

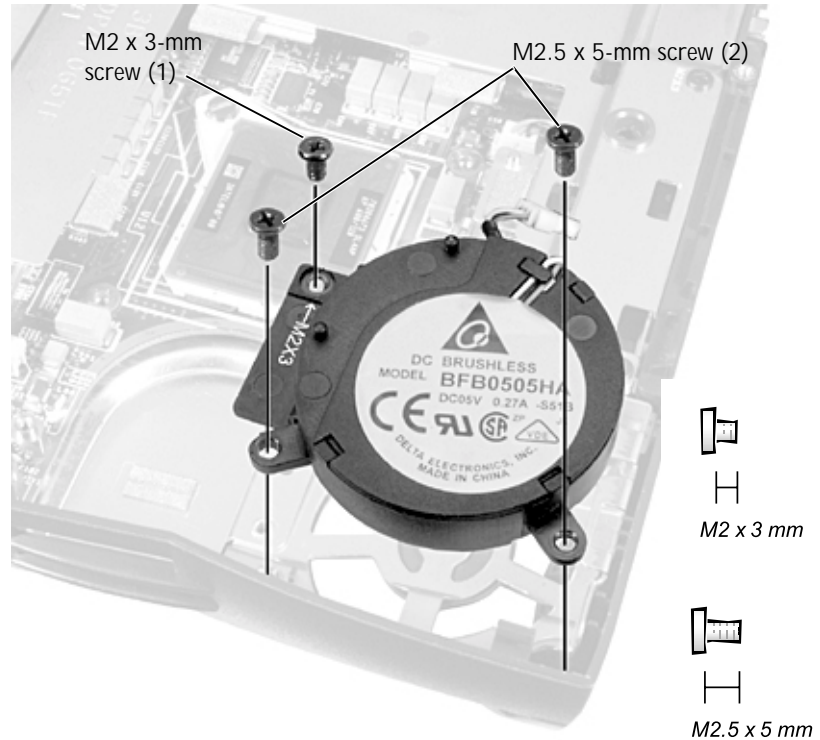

- 6 Remove the two M2.5 x 5-mm screws and the one M2 x 3-mm screw that secure the hybrid cooling fan to the system board.
- 7 Disconnect the fan power cable from the system board interface connector and remove the hybrid cooling fan.

HINT: The fan power cable is long and can be pulled out from under the EMI shield to provide access to the connector.

CAUTION: Do not block the keyboard screw hole when reinserting the fan cable.

Microprocessor Module

- ➔ **NOTICE:** Hold the microprocessor down while turning the cam screw to prevent intermittent contact between the cam screw and the microprocessor.

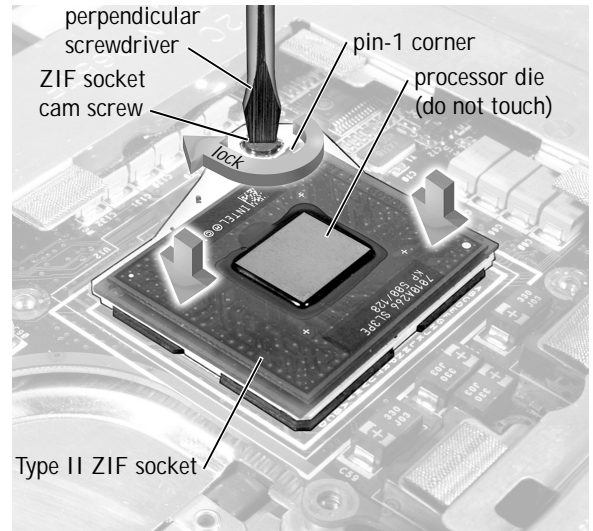
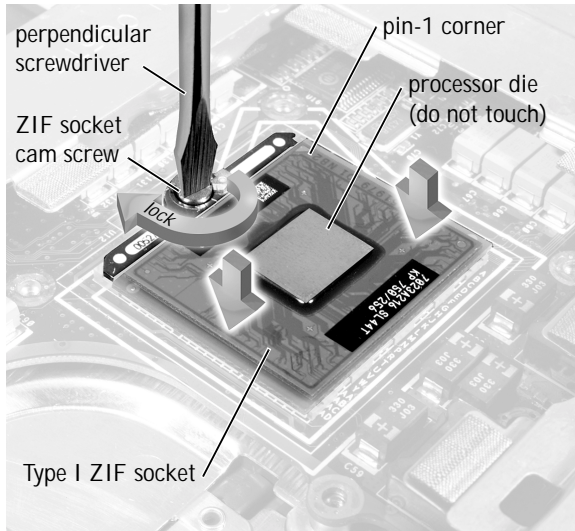

- ➔ **NOTICE:** Disconnect the computer and any attached devices from electrical outlets, and remove any installed batteries.
 - ➔ **NOTICE:** To avoid ESD, ground yourself by using a wrist grounding strap or by touching an unpainted metal surface on the computer.
 - ➔ **NOTICE:** Read “[Preparing to Work Inside the Computer](#)” before performing the following procedure.
- 1 Remove the [hard drive assembly](#).
 - 2 Turn the computer over and remove the [keyboard](#).
- ➔ **NOTICE:** To ensure maximum cooling for the microprocessor, do not touch the heat transfer areas on the thermal cooling assembly. The oils in your skin reduce the heat transfer capability of the thermal pads.
- 3 Remove the [thermal cooling assembly](#).
- ➔ **NOTICE:** When removing the microprocessor module, pull the module straight up. Be careful not to bend the pins on the microprocessor module.
- 4 Remove the microprocessor module:



HINT: To update or reflash the BIOS, see the *Dell Portable Computer BIOS Update Guide* for instructions.

➡ **NOTICE:** To avoid damaging the microprocessor while removing the cam screw, hold the screwdriver so that it is perpendicular to the microprocessor.

- a Use a small flat-head screwdriver and rotate the ZIF socket cam screw 180 degrees to loosen the ZIF socket.

The ZIF socket cam screw secures the microprocessor assembly to the system board assembly. Take note of the arrow on the ZIF socket cam screw points to the front of the computer when engaged.

- b Use a microprocessor extraction tool to remove the microprocessor module.

Replacing the Microprocessor Module

➡ **NOTICE:** After replacing the microprocessor module, update the BIOS using a flash BIOS update program floppy disk or CD.

➡ **NOTICE:** Seating the microprocessor module properly in the ZIF socket does not require force.

➡ **NOTICE:** A microprocessor module that is not properly seated can result in an intermittent connection or permanent damage to the microprocessor and ZIF socket.

- 1 Align the pin-1 corner of the microprocessor module with the pin-1 corner of the microprocessor socket on the system board and insert the microprocessor module.

➡ **NOTICE:** You must position the microprocessor module correctly in the ZIF socket to avoid permanent damage to the module and the socket.

When the microprocessor module is correctly seated, all four corners are aligned to the same height. If one or more corners of the module are higher than the others, the module is not seated correctly.

➡ **NOTICE:** Hold the microprocessor down while turning the cam screw to prevent intermittent contact between the cam screw and microprocessor.

- 2 Tighten the ZIF socket cam screw to secure the microprocessor module to the system board assembly.

Reserve Battery

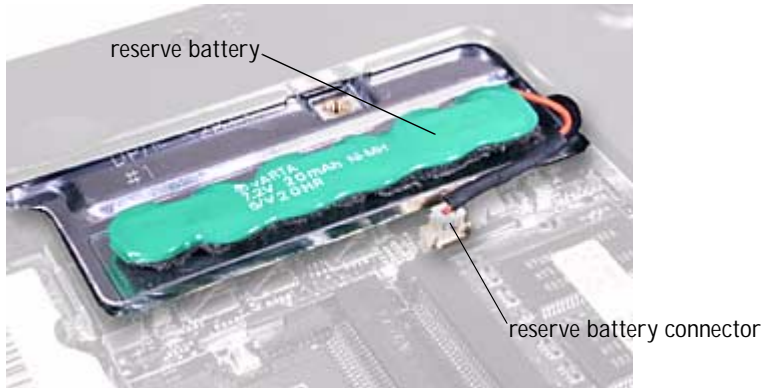

- ➔ **NOTICE:** The reserve battery provides power to the computer's RTC and NVRAM when the computer is turned off. Removing the battery causes the computer to lose the date and time information as well as all user-specified parameters in the BIOS. If possible, make a copy of this information before you remove the reserve battery.

Removing the Reserve Battery

- ➔ **NOTICE:** Disconnect the computer and any attached devices from electrical outlets, and remove any installed batteries.
- ➔ **NOTICE:** To avoid ESD, ground yourself by using a wrist grounding strap or by touching an unpainted metal surface on the computer.
- ➔ **NOTICE:** Read "[Preparing to Work Inside the Computer](#)" before performing the following procedure.

- 1 Remove the [hard drive assembly](#).
- 2 Remove the [memory module cover](#).
- 3 Disconnect the reserve battery cable from the connector on the system board assembly located next to the reserve battery.
- 4 Remove the reserve battery from the EMI shield:
 - a Pry the reserve battery free from the foam pad.
 - b Remove the remnants of the foam pad from the EMI shield.

 **HINT:** To update or reflash the BIOS, see the *Dell Portable Computer BIOS Update Guide* for instructions.

Replacing the Reserve Battery

- 1 Connect the reserve battery cable to the connector on the system board.
- 2 Position the reserve battery on the EMI shield next to the connector to minimize slack in the cable.

System Speaker Assembly

The system speakers are located on the front left and right sides of the bottom case assembly. Each speaker assembly is marked with a right and left label. Take note of the speaker cable routing in the bottom case assembly so that you can replace it correctly.



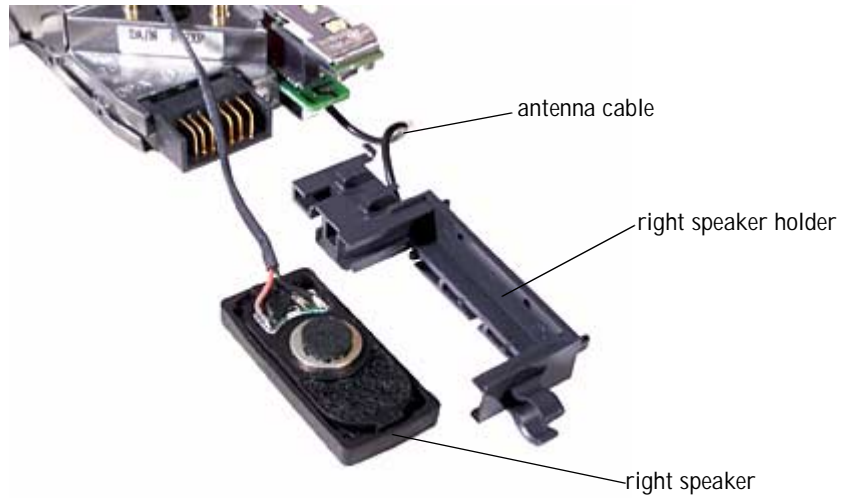
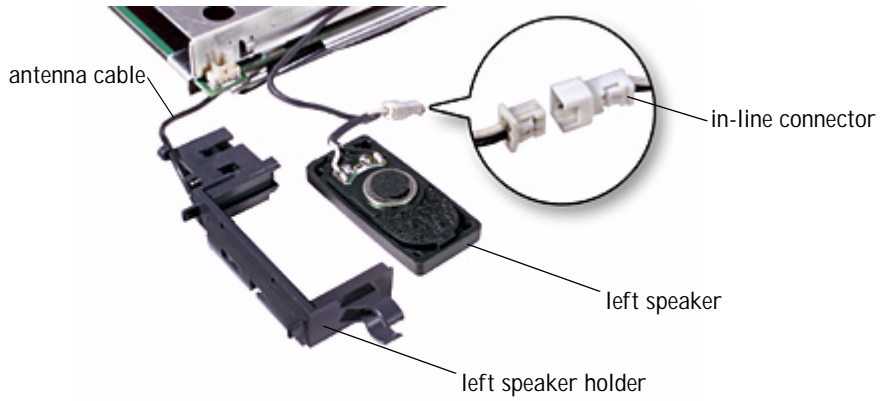

Removing the Speaker Assembly

- ➡ **NOTICE:** Disconnect the computer and any attached devices from electrical outlets, and remove any installed batteries.
- ➡ **NOTICE:** To avoid ESD, ground yourself by touching an unpainted metal surface or by using a wrist grounding strap.
- ➡ **NOTICE:** Read “[Preparing to Work Inside the Computer](#)” before performing the following procedure.



- 1 Remove the [hard drive assembly](#).
- 2 Remove the [keyboard assembly](#).
- 3 Turn the computer over and remove the [display assembly](#).
- 4 Remove the [palm rest assembly](#).
- 5 Remove the [thermal cooling assembly](#).
- 6 Disconnect the speaker interface cable connectors.

 **HINT:** The left speaker has an in-line connector, and its cable is shorter than the right speaker.

 **HINT:** Speakers face out in the bottom case assembly holders.

- 7 Remove the speaker assemblies by pulling them straight up and out of the bottom case assembly.

Replacing the Speaker Assembly

- 1 To replace the speaker assembly, place the mounting ring over the front palm rest screw post.
- 2 Slide the speaker assembly down into the bottom case assembly.

System Board Assembly

The system board's BIOS chip contains the system service tag number, which is also visible on a bar-code label on the bottom of the computer. The replacement kit for the system board assembly includes a floppy disk that provides a utility for transferring the service tag number to the replacement system board assembly.

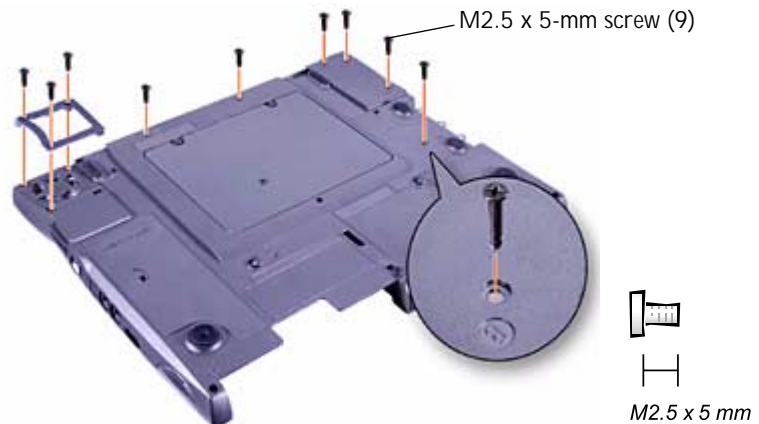

Removing the System Board

-  **NOTICE:** Disconnect the computer and any attached devices from electrical outlets, and remove any installed batteries.

➔ **NOTICE:** To avoid ESD, ground yourself by using a wrist grounding strap or by periodically touching an unpainted metal surface on the computer.

➔ **NOTICE:** Read “[Preparing to Work Inside the Computer](#)” before performing the following procedure.

- 1 Remove the [hard drive assembly](#).
- 2 Turn the computer over and remove the [keyboard assembly](#).
- 3 Remove the [display assembly](#).
- 4 Remove the [palm rest assembly](#).
- 5 Verify that all PC Cards or plastic blanks are removed from the PC Card slot.
- 6 Verify that the PC Card ejectors do not extend from the PC Card slot.
- 7 Turn the computer upside down, and remove the nine M2.5 x 5-mm screws labeled with a “circle B” that secure the system board assembly to the bottom case assembly:
 - a Remove the three M2.5 x 5-mm screws that secure the thermal cooling fan protective cover to the bottom case assembly. The thermal cooling fan protective cover is located at the back on the right side of the bottom case assembly.
 - b Remove the remaining six M2.5 x 5-mm screws from the bottom case assembly.

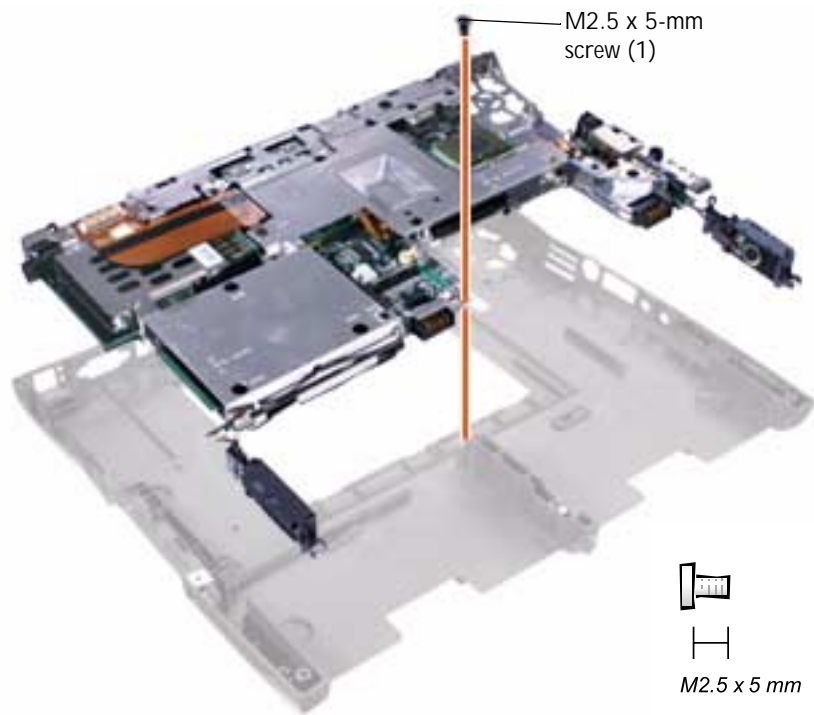



- 8 Turn the bottom case assembly right-side up and remove the M2.5 x 5-mm screw labeled with a white circle on the front center of the system board.
- 9 Remove the [speakers](#) from the bottom case assembly.
- 10 Pull the right side of the bottom case assembly, next to the external headphone and microphone connectors, away from the system board assembly as you simultaneously lift the front of the system board assembly out and away from the bottom case assembly.

Replacing the System Board

- 1 Install the microprocessor on the replacement system board.
- 2 Connect the right and left speaker to the replacement system board.
- 3 Install the replacement system board:

- a Insert the external microphone and headphone connectors through the plastic bottom case assembly.
 - b Replace the nine M2.5 x 5-mm screws, starting on the right side of the bottom case assembly.
 - c Replace the thermal cooling fan protective cover, inserting the tab into the bottom case assembly and replacing the three M2 x 4-mm screws. If you replace the screw opposite the tab first, the other two screws are easier to insert and replace.
- 4 Replace any subassemblies that you may have removed, including the memory modules, PCI card cage, Mini PCI card, speaker modules, thermal cooling assembly, and hybrid cooling fan.
 - 5 Replace the palm rest assembly, the display assembly, the hard drive, and the keyboard assembly.
 - 6 Replace the modular bay devices and any PC Cards or plastic blanks in the PC Card slot.
 - 7 Insert the floppy disk or CD that accompanied the replacement system board assembly into the appropriate drive, and turn on the computer. Follow the instructions on the display screen.

 **HINT:** Be sure to route cables so that they will not be crimped or pinched when the complete assembly is put back together.

 **HINT:** After replacing the system board assembly, be sure to enter the system's service tag number into the BIOS of the replacement system board assembly.

Module Latch Assemblies

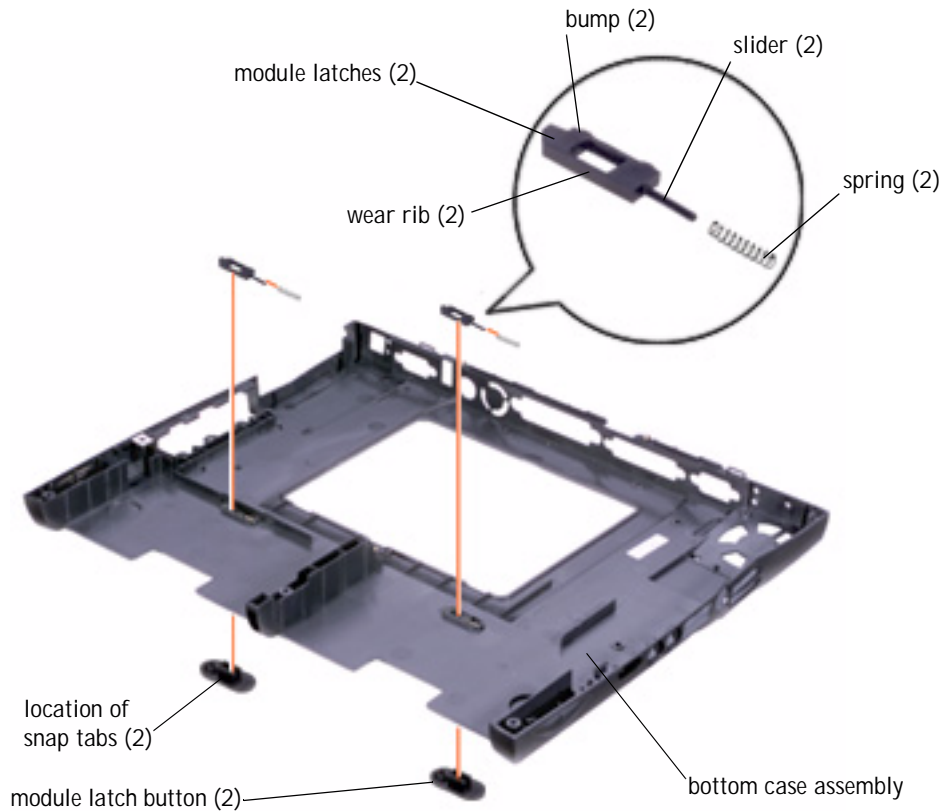

Removing the Module Latch Assemblies

- ➔ **NOTICE:** Disconnect the computer and any attached devices from electrical outlets, and remove any installed batteries.
 - ➔ **NOTICE:** To avoid ESD, ground yourself by using a wrist grounding strap or by touching an unpainted metal surface on the computer.
 - ➔ **NOTICE:** Read "[Preparing to Work Inside the Computer](#)" before performing the following procedure.
- 1 Remove the [hard drive assembly](#).
 - 2 Turn the computer over and remove the [keyboard assembly](#).

- 3 Remove the [display assembly](#).
- 4 Remove the [palm rest assembly](#).
- 5 Remove the left module latch button from the bottom case assembly by squeezing the snap tabs.

Apply pressure to the module latch and spring while unsnapping the snap tabs to prevent the module latch assembly from coming loose from the case. If the module latch assembly does come loose from the case:

- a Reinsert the spring onto the slider on the module latch, and reinstall the module latch into the holding features on the inside of the case.
 - b Ensure that the slider is inserted in its respective hole, that the side of the latch with the two bumps is facing the back of the case, and that the surface with the wear ribs is facing the bottom of the case.
- 6 Snap in the new latch button from the bottom of the base, making certain its snap tabs are fully engaged in the module latch.
 - 7 Ensure that the newly installed latch moves smoothly and freely when pushed and released.
 - 8 Repeat steps 5 through 7 for the latch on the right side.



HINT: The latch will not function properly if the slider is oriented incorrectly.

