

Dell™ Inspiron™ 8200

[A Tour of Your Computer](#)

[Solving Problems](#)

[Using Dell Diagnostics](#)

[Reinstalling Drivers and Utilities](#)

[Reinstalling Microsoft® Windows® XP](#)

[System Setup Program](#)

[Specifications](#)

[Power Management](#)

[Pin Assignments for I/O Connectors](#)

[Removing and Replacing Parts](#)

[Documentation](#)

Hints, Notices, and Cautions



HINT: A HINT indicates important information that helps you make better use of your computer.



NOTICE: A NOTICE indicates either potential damage to hardware or loss of data and tells you how to avoid the problem.



CAUTION: A CAUTION indicates a potential for property damage, personal injury, or death.

Abbreviations and Acronyms

For a complete list of abbreviations and acronyms, see the *Tell Me How* help file. To access the *Tell Me How* help file, click the **Start** button on the Microsoft® Windows® desktop, and then click **Help and Support**. Click **User and system guides**, and then click **User's guides**. Click **Tell Me How**.

Trademarks used in this text: *Dell*, the *DELL* logo, *Inspiron*, *AccessDirect*, and *Dell Travellite* are trademarks of Dell Computer Corporation; *Intel* and *Pentium* are registered trademarks of Intel Corporation; *ATI Mobility* and *RADEON* are trademarks of ATI Technologies Inc.; *Microsoft*, *MS-DOS*, and *Windows* are registered trademarks of Microsoft Corporation; *GeForce2 Go* is a registered trademark of NVIDIA Corporation; Adobe is the trademark of Adobe Systems Incorporated which may be registered in certain jurisdictions.

Other trademarks and trade names may be used in this document to refer to either the entities claiming the marks and names or their products. Dell Computer Corporation disclaims any proprietary interest in trademarks and trade names other than its own.

October 2002 Rev. A01

[Back to Contents Page](#)

A Tour of Your Computer

Dell™ Inspiron™ 8200

- [Front View](#)
 - [Left Side View](#)
 - [Right Side View](#)
 - [Back View](#)
 - [Bottom View](#)
-

Front View







1	display latch	9	battery bay
2	display	10	module bay
3	device status lights	11	touch pad/track stick buttons

4	air vent	12	Dell AccessDirect buttons
5	keyboard status lights	13	power button
6	keyboard	14	microphone
7	track stick	15	volume control buttons
8	touch pad		

Display Latch— Keeps the display closed.

Display— The computer has a color LCD.

Device Status Lights

	Turns on when you turn on the computer.
	Turns on when the computer reads or writes data.  NOTICE: To avoid loss of data, never turn off the computer while the  light is flashing.
	Turns on steadily or blinks when the computer is in a power management mode. It also blinks to indicate battery charge status.

If the computer is connected to an electrical outlet, the  light operates as follows:

- Solid green: The battery is charging.
- Flashing green: The battery is fully charged.

If the computer is running on a battery, the  light operates as follows:

- Off: The battery is adequately charged (or the computer is turned off).
- Flashing orange: The battery charge is low.
- Solid orange: The battery charge is critically low.

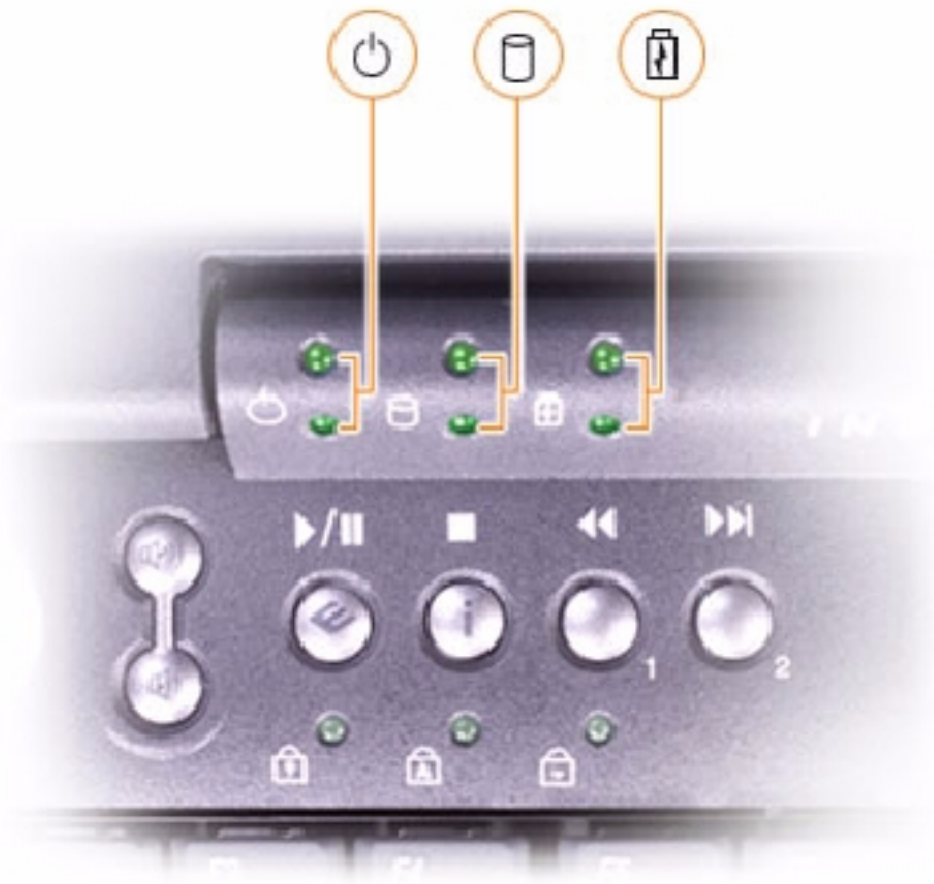



Air Vents— The computer uses an internal fan to create airflow through the vents, which prevents the computer from overheating.

 **HINT:** The computer turns on the fans when the computer gets hot. The fans may make noise, which is normal and does not indicate a problem with the fans or the computer

 **CAUTION:** Do not block, push objects into, or allow dust to accumulate in the air vents. Doing so can damage the computer or cause a fire.

Keyboard Status Lights— The green lights located above the keyboard indicate the following:

	Turns on when the numeric keypad is enabled
	Turns on when the uppercase letter function is enabled
	Turns on when the scroll lock function is enabled

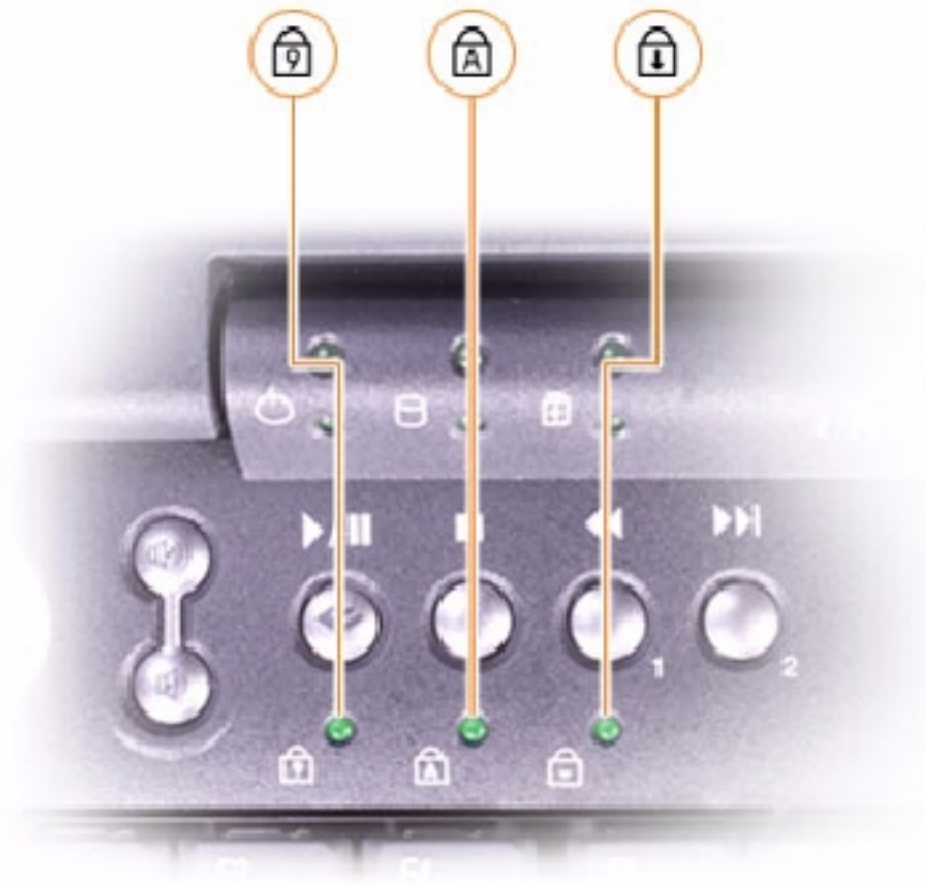

Keyboard— The keyboard includes a numeric keypad as well as the Microsoft® Windows® logo key  .

Track Stick— Use the track stick and track stick buttons as you would use a mouse.

Touch Pad— Use the touch pad and touch pad buttons as you would use a mouse.

Battery Bay— When a battery is installed, you can use the computer without connecting it to an electrical outlet.

Module Bay— You can install devices such as a CD drive, CD-RW drive, DVD drive, or Dell Travellite™ module in the module bay.

Touch Pad/Track Stick Buttons— Correspond to the left and right buttons on a standard mouse.





Dell™ AccessDirect™ Buttons— Press the buttons to launch various resources, such as your default Internet browser and e-mail program.





Power Button— Press the power button to turn on the computer or to enter or exit standby or hibernate mode.

If the computer stops responding, press and hold the power button until the computer turns off completely (which may take about 4 seconds).

➔ **NOTICE:** Turn off your computer by performing a Windows shutdown. Otherwise, you may lose data.

Microphone— Allows you to record audio.

Volume Control Buttons— Increase or decrease the speaker volume with these buttons. Alternatively, you can increase speaker volume by pressing   and decrease speaker volume by pressing  .

You can enable or disable (mute) the integrated stereo speakers or external speakers by pressing  . When you mute music, the computer may take a moment to respond. Certain audio utilities installed on your computer also allow you to control speaker volume. If no sound comes from the speakers, press   and check the volume control buttons to make sure that the sound is not disabled.

Left Side View



1	fixed optical drive
2	S-video TV-out connector
3	security cable slot
4	modem connector
5	network connector
6	speaker

Fixed Optical Drive— Accommodates devices such as a CD drive, DVD drive, CD-RW drive, or CD-RW/DVD combo drive.

S-Video TV-Out Connector

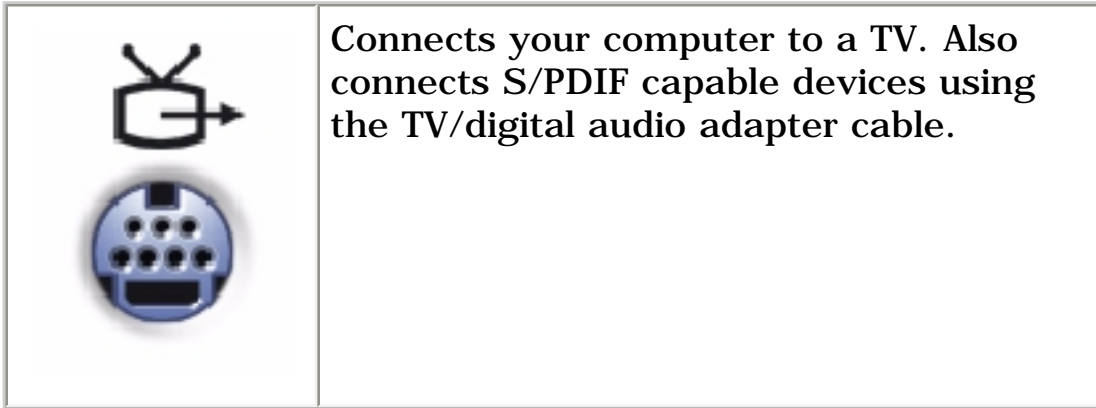

Security Cable Slot— Lets you attach a commercially available antitheft device to the computer. Instructions for installing antitheft devices are usually included with the device.

 **NOTICE:** Before you buy an antitheft device, ensure that it will work with the security cable slot.

Modem Connector

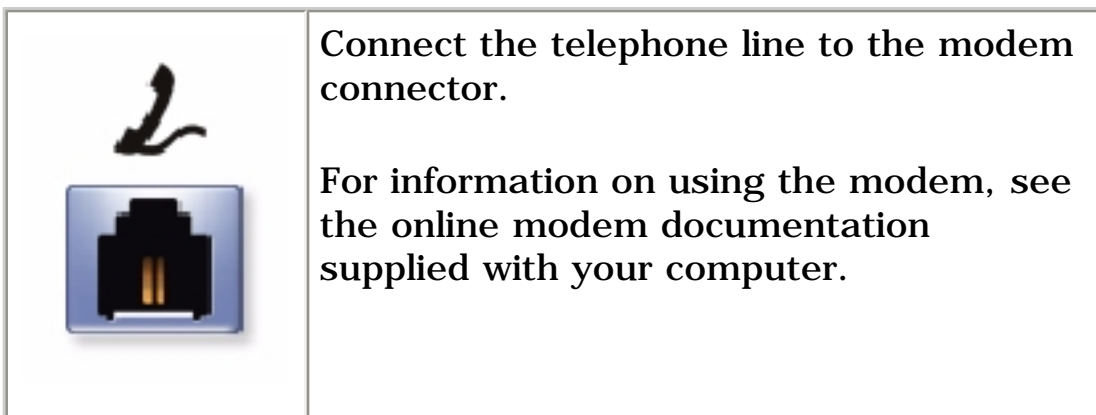

Network Connector



Connects the computer to a network. The light on the right flashes amber to indicate network activity. The light on the left turns red/orange when the computer is connected to a 100-Mbps network; the light turns green for a 10-Mbps network or a wireless card.

For information on using the network adapter, see the online network adapter documentation supplied with your computer.

➔ **NOTICE:** The network connector is slightly larger than the modem connector. Do not plug a telephone line into the network connector.

Speakers— Press the volume control buttons or volume control keyboard shortcuts to adjust the volume of the integrated speakers.

Right Side View



1	speaker	5	IEEE 1394 connector
2	security cable slot	6	PC Card slot
3	hard drive bay	7	audio connectors
4	infrared sensor	8	air vents

Speakers— Press the volume control buttons or volume control keyboard shortcuts to adjust the volume of the integrated speakers.

Security Cable Slot— Lets you attach a commercially available antitheft device to the computer. Instructions for installing antitheft devices are usually included with the

device.



➡ **NOTICE:** Before you buy an antitheft device, ensure that it will work with the security cable slot.

Hard Drive— Reads and writes data on a hard disk.

Infrared Sensor— The infrared sensor lets you transfer files from your computer to another infrared-compatible device without using cable connections.



IEEE 1394 Connector— Use this connector to attach devices supporting IEEE 1394 high-speed transfer rates, such as some digital cameras and video cameras.

PC Card Slot— Has two connectors that support various types of PC Cards, including modems and network adapters.

Audio Connectors

Attach record/playback devices, such as cassette players and CD players, to the  connector.

Attach headphones or speakers to the  connector.

Attach a microphone to the  connector.

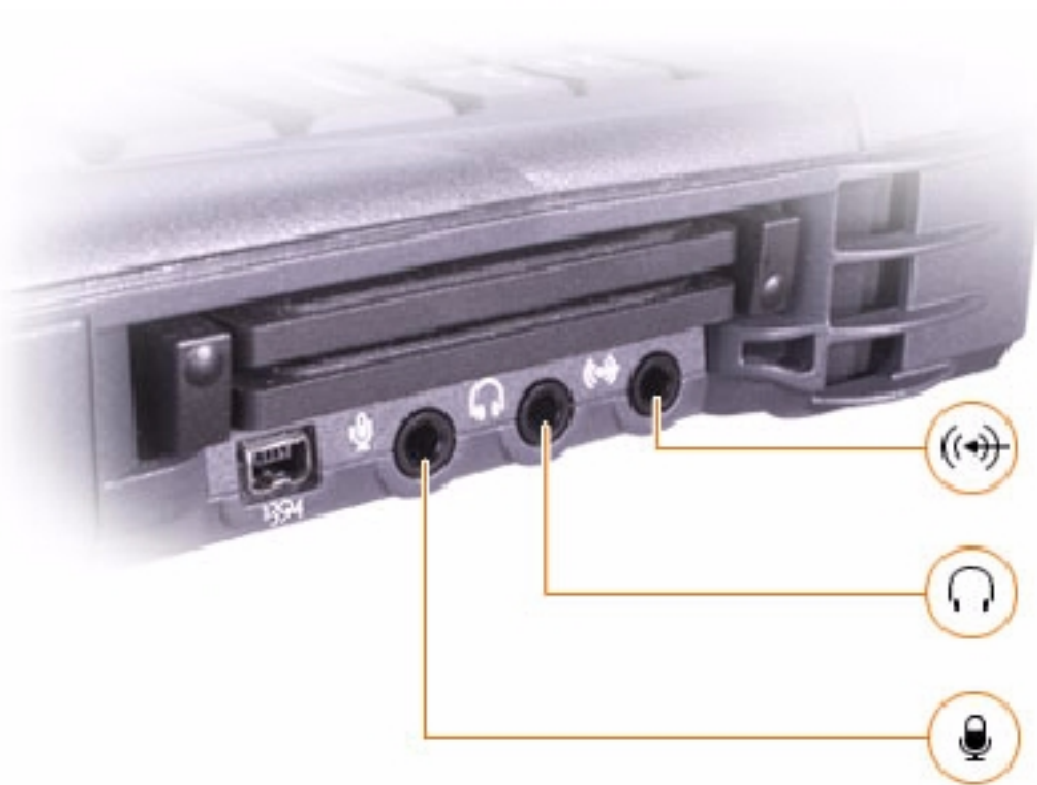

Air Vents— The computer uses an internal fan to create airflow through the vents, which prevents the computer from overheating.



HINT: The computer turns on the fans when the computer gets hot. The fans may make noise, which is normal and does not indicate a problem with the fans or the computer.

⚠ CAUTION: Do not block, push objects into, or allow dust to accumulate in the air vents. Doing so can damage the computer or cause a fire.

Back View

➡ NOTICE: To avoid damaging the computer, wait 5 seconds after turning off the computer before you disconnect an external device.

⚠ CAUTION: Do not block, push objects into, or allow dust to accumulate in the air vents. Doing so can damage the computer or cause a fire.



1	air vents	5	docking connector
2	AC adapter connector	6	parallel connector
3	PS/2 connector	7	serial connector
4	video connector	8	USB connectors (2)

Air Vents— The computer uses an internal fan to create airflow through the vents, which prevents the computer from overheating.

🔪 HINT: The computer turns on the fans when the computer gets hot. The fans may make noise, which is normal and does not indicate a problem with the fans or the computer.

⚠ CAUTION: Do not block, push objects into, or allow dust to accumulate in the air vents. Doing so can damage the computer or cause a fire.

📎 HINT: Use only the 90-watt AC adapter supplied with the computer.

AC Adapter Connector— Attach the 90-watt AC adapter to the computer.



The AC adapter converts AC power to the DC power required by the computer. You can connect the AC adapter with your computer turned either on or off.

⚠ CAUTION: The AC adapter works with electrical outlets worldwide. However, power connectors and power strips vary among countries. Using an incompatible cable or improperly connecting the cable to the power strip or electrical outlet may cause fire or equipment damage.

🔄 NOTICE: When you disconnect the AC adapter from the computer, grasp the adapter cable connector, not the cable itself, and pull firmly but gently to avoid damaging the cable.

PS/2 Connector

📎 HINT: You can use the integrated keyboard and an external keyboard at the same time. When you attach a PS/2 keyboard or PS/2 numeric keypad, the integrated keypad is disabled.



Connects PS/2-compatible devices, such as a mouse, keyboard, or external numeric keypad.

Shut down the computer before attaching or removing a PS/2-compatible device. If the device does not work, install the device drivers from the floppy disk or CD that came with the device, and restart the computer.

Video Connector



Connects an external monitor.

Docking Connector



HINT: Docking devices may not be available in all countries.



Connects the optional docking device. A docking device allows you to easily use external devices with your computer, such as an external keyboard, mouse, and monitor.

See the documentation that came with your docking device for additional information.

Parallel Connector



Connects a parallel device, such as a printer.

Serial Connector



Connects serial devices, such as a mouse or handheld device.

USB Connector



Connects USB devices, such as a mouse, keyboard, or printer.

Bottom View

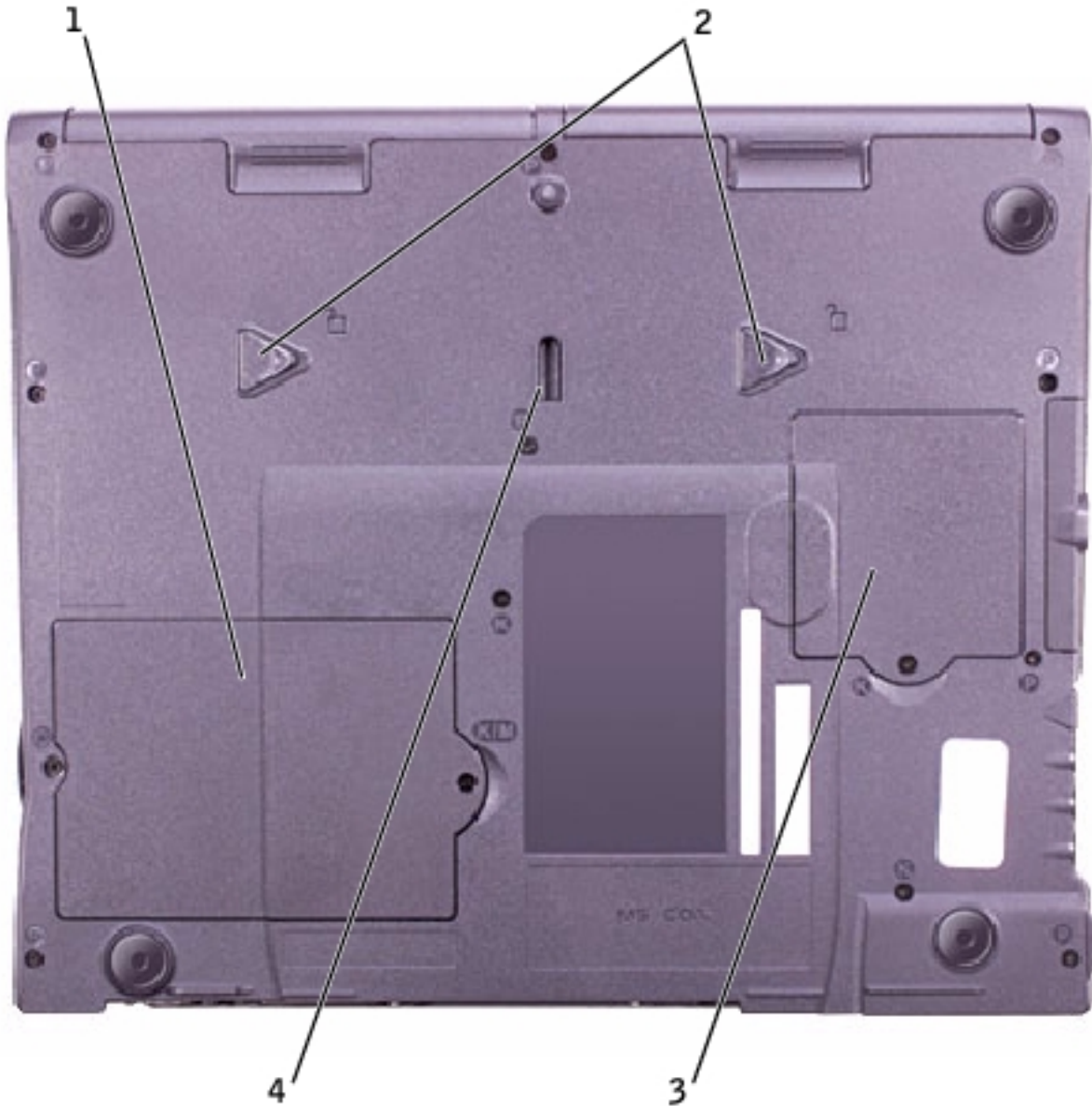

1	memory module and modem cover
2	device release latches
3	Mini PCI card cover
4	docking device latch

Memory Module and Modem Cover— Protects the memory module(s) and the modem daughter card.

Device Release Latches— Press and hold a release latch to remove a device in the

module bay.

Mini PCI card cover— Covers the compartment that contains the optional Mini PCI card.

Docking Device Latch— Latches onto the docking device.

[Back to Contents Page](#)

[Back to Contents Page](#)

Solving Problems

Dell™ Inspiron™ 8200

- [Accessing Help](#)
- [Power Problems](#)
- [Start-Up Error Messages](#)
- [Video and Display Problems](#)
- [Sound and Speaker Problems](#)
- [Printer Problems](#)
- [Modem and Internet Connection Problems](#)
- [Scanner Problems](#)
- [Touch Pad or Mouse Problems](#)
- [External Keyboard Problems](#)
- [Unexpected Characters](#)
- [Drive Problems](#)
- [PC Card Problems](#)
- [Network Problems](#)
- [Error Messages](#)
- [General Program Problems](#)
- [E-Mail Problems](#)
- [Resolving Other Technical Problems](#)
- [If Your Computer Gets Wet](#)
- [If You Drop or Damage Your Computer](#)

Accessing Help

To access the Tell Me How help file

1. Click the **Start** button and then click **Help and Support**.
2. Click **User and system guides** and then click **User's guides**.
3. Click **Tell Me How**.

To access help

1. Click the **Start** button and then click **Help and Support**.
2. Type a word or phrase that describes your problem and then click the arrow icon.
3. Click the topic that describes your problem.
4. Follow the instructions shown on the screen.

Power Problems



HINT: See the *Tell Me How* help file for information on standby mode.

Check the power light— When the power light is lit or blinking, the computer has power. If the power light is blinking, the computer is in standby mode—press the power button to exit standby mode. If the light is off, press the power button to turn on the computer.

Charge the battery— The battery charge may be depleted.

1. Reinstall the battery.
2. Use the AC adapter to connect the computer to an electrical outlet.
3. Turn on the computer.

Check the battery status light— If the battery status light flashes orange or is a steady orange, the battery charge is low or depleted. Connect the computer to an electrical outlet.

If the battery status light flashes green and orange, the battery is too hot to charge. Turn off the computer, disconnect the computer from the electrical outlet, and then let the battery and computer cool to room temperature.

If the battery status light rapidly flashes orange, the battery may be defective. Contact Dell (see "Contacting Dell" in the Dell™ *Owner's Manual* that came with your computer).

Test the electrical outlet— Ensure that the electrical outlet is working by testing it with another device, such as a lamp.

Check the AC adapter— Check the AC adapter cable connections. If the AC adapter has a light, ensure that the light is on.

Connect the computer directly to an electrical outlet— Bypass power protection devices, power strips, and the extension cable to verify that the computer turns on.

Eliminate possible interference— Turn off nearby fans, fluorescent lights, halogen lamps, or other appliances.

Adjust the Power Properties— See the *Tell Me How* help file or search for the keyword *standby* in the Help and Support Center. To access the help file, see "[Accessing Help](#)."

Reseat the memory modules— If the computer power light turns on but the display remains blank, reseat the memory modules.

Ensuring Sufficient Power for Your Computer

Your computer's Intel® Mobile Pentium®4 microprocessor requires more power than the microprocessors used in Dell's earlier portable computers. Your computer is designed to use the 90-W AC adapter and the 4400-mAh battery that shipped with it; for optimum system performance, you should always use these components.

The 70-W AC adapters used in some of Dell's earlier portable computers can be used with your computer, but they will decrease system performance. Likewise, you can use the 3800-mAh and 3600-mAh batteries from earlier Dell computers, but these lesser-capacity batteries will discharge faster. Using less-powerful AC adapters or

batteries may cause you to receive a **WARNING** or a **SYSTEM CONFIGURATION ERROR** message similar to the following:

WARNING: 70 Watt AC adapter detected. System will not be capable of running in full performance without a 90 Watt AC adapter.

 **NOTICE:** Do not use an AC adapter rated under 70 W or a battery rated under 3600 mAh in this computer. To do so will cause indeterminate results, including data loss and/or immediate system shutdown. Using one of these lower-powered components will cause a **SYSTEM CONFIGURATION ERROR** message to appear.

Docking Power Considerations

 **HINT:** If you want to upgrade the AC adapter for an existing Dell docking device, you can purchase an additional 90-W AC adapter from Dell.

The 4400-mAh battery supplied with the computer is not designed to support both the computer and a docking device. For optimum system performance, always use the 90-W AC adapter (with or without a battery installed) when using the computer in a docking device. You can identify the 90-W adapter by the lighter-gray tip on the connector that plugs into the computer or docking device.

Using a 70-W AC adapter will cause the computer to run in reduced-performance mode and may display an AC adapter **WARNING** message.

Docking While the Computer Is Running

To accommodate the initial power surge when connecting to a docking device with the computer running in normal (non-power conservation) mode, a 90- or 70-W AC adapter and at least one battery (a 4400- or 3800-mAh battery) must be installed in the computer. The computer will then run in either full-performance or reduced-performance mode, depending on the battery/AC adapter combination installed.

AC Power Loss While the Computer Is Docked

If a computer loses AC power while docked, the computer immediately goes into low-performance mode and displays an appropriate **WARNING** message.

Start-Up Error Messages

Operating system not found—

Contact Dell for technical assistance (see "Contacting Dell" in the Dell *Owner's Manual* that came with your computer).

Insert bootable media—

The operating system is trying to boot to a nonbootable floppy disk or CD. Insert a bootable floppy disk or CD.

Non-system disk error—

A floppy disk is in the floppy drive. Remove the floppy disk and restart the computer.

Video and Display Problems



If the display is blank



HINT: If you are using a program that requires a higher resolution than your computer supports, Dell recommends that you attach an external monitor to your computer.

Check the light—

When the  light is blinking, the computer has power.

- If the  light is blinking, the computer is in standby mode—press the power button to exit standby mode.
- If the  light is off, press the power button.
- If the  light is on, your power management settings may have caused the display to turn off. Try pressing any key or move the cursor to exit standby mode.

Check the battery—

If you are using a battery to power your computer, the battery charge may be depleted. Connect the computer to an electrical outlet using the AC adapter, and turn on the computer.

Test the electrical outlet—

Ensure that the electrical outlet is working by testing it with another device, such as a lamp.

Check the AC adapter—

Check the AC adapter cable connections. If the AC adapter has a light, ensure that it is on.

Connect the computer directly to an electrical outlet—

Bypass power protection devices, power strips, and the extension cable to verify that the computer turns on.

Adjust the Power Properties—

See the *Tell Me How* help file, or search for the keyword *standby* in the Microsoft® Windows® Help and Support Center. To access the help file, see "[Accessing Help](#)."

Switch the video image—

If your computer is attached to an external monitor, press



to

switch the video image to the display.

If the display is difficult to read

Adjust the brightness—

See the *Tell Me How* help file for instructions on adjusting the brightness. To access the help file, see "[Accessing Help](#)."

Move the subwoofer away from the computer or monitor—

If your external speaker system includes a subwoofer, ensure that the subwoofer is at least 60 cm (2 ft) away from the computer or external monitor.

Eliminate possible interference—

Turn off nearby fans, fluorescent lights, halogen lamps, or other appliances.

Rotate the computer to face a different direction—

Eliminate sunlight glare, which can cause poor picture quality.

Adjust the Windows display settings

1. Click the **Start** button and then click **Control Panel**.
2. Click **Appearance and Themes**.
3. Click the area you want to change or click the **Display** icon.
4. Try different settings for **Color quality** and **Screen resolution**.

See "Error Messages"—

If an error message appears, see "[Error Messages](#)."

If only part of the display is readable

Connect an external monitor

1. Turn off your computer and connect an external monitor to the computer.
2. Turn on the computer and the monitor and adjust the monitor brightness and contrast controls.

If the external monitor works, the computer display or video controller may be defective. Contact Dell (see "Contacting Dell" in the Dell *Owner's Manual* that came with your computer).

Sound and Speaker Problems

If you have a problem with integrated speakers

Adjust the Windows® volume control— Double-click the speaker icon in the lower-right corner of your screen. Ensure that the volume is turned up and that the sound is not muted. Adjust the volume, bass, or treble controls to eliminate distortion.

Adjust the volume using keyboard shortcuts— See "Using the

Keyboard and Touch Pad" in the *Tell Me How* help file. Press   to disable (mute) or reenable the integrated speakers.

Reinstall the sound (audio) driver— See "[Reinstalling Drivers and Utilities](#)."

If you have a problem with external speakers

 **HINT:** The volume control in some MP3 players overrides the Windows volume setting. If you have been listening to MP3 songs, make sure that you did not turn the player volume down or off.

Check the speaker cable connections— See the setup diagram supplied with the speakers.

Test the electrical outlet— Ensure that the electrical outlet is working by testing it with another device, such as a lamp.

Ensure that the speakers are turned on— See the setup diagram supplied with the speakers.

Adjust the Windows volume control— Double-click the speaker icon in the lower-right corner of your screen. Ensure that the volume is turned up and that the sound is not muted. Adjust the volume, bass, or treble controls to eliminate distortion.

Test the speakers— Plug the speaker audio cable into the line-out connector on the computer. Ensure that the headphone volume control is turned up. Play a music CD.

Run the speaker self-test— Some speaker systems have a self-test button on the subwoofer. See the speaker documentation for self-test instructions.

Eliminate possible interference— Turn off nearby fans, fluorescent lights, or halogen lamps to check for interference.

Reinstall the sound (audio) driver— See "[Reinstalling Drivers and Utilities](#)."

Printer Problems

Check the printer cable connections—

Ensure that the printer cable is properly connected to the computer.

Test the electrical outlet—

Ensure that the electrical outlet is working by testing it with another device, such as a lamp.

Ensure that the printer is turned on—



See the documentation supplied with the printer.

Verify that Windows® recognizes the printer

1. Click the **Start** button.
2. Click **Control Panel**.
3. Click **Printers and Other Hardware**.
4. Click **View installed printers or fax printers**. If the printer model is listed, right-click the printer icon.
5. Click **Properties**, and then click the **Ports** tab. Ensure that the **Print to the following port(s)**: setting is **LPT1 (Printer Port)**.

Reinstall the printer driver— See "[Reinstalling Drivers and Utilities](#)."

Modem and Internet Connection Problems

-  **NOTICE:** Connect the modem to an analog telephone wall jack only. Connecting the modem to a digital telephone network damages the modem.
-  **NOTICE:** Modem and network connectors look similar. Do not plug a telephone line into the network connector.
-  **HINT:** If you can connect to your Internet service provider (ISP), your modem is functioning properly. If you are sure that your modem is working properly and you still experience problems, contact your ISP.

Check the telephone wall jack—

Disconnect the telephone line from the modem and connect it to a telephone. Listen for a dial tone. Ensure that you have touchtone telephone service. Try connecting the modem to a different telephone wall jack.

Slow connection speeds can be caused by telephone noise as well as by telephone line or network conditions. Contact your telephone company or network administrator for more information.

Connect the modem directly to the telephone wall jack—

If you have other telephone devices sharing the line, such as an answering machine, fax machine, surge protector, or line splitter, then bypass them and use the telephone line to connect the modem directly to the telephone wall jack.

Check the connection—

Verify that the telephone line is connected to the modem.

Check the telephone line—

Try using a different telephone line. If you are using a line that is 3 m (10 ft) or more in length, try a shorter one.

Irregular dial tone —

If you have voice mail service, you might hear an irregular dial tone when you have messages. Contact your telephone company for instructions on restoring a dial tone.

Turn off call waiting (catch-phone)—

See your telephone directory for instructions on deactivating this feature. Then adjust the dial-up networking connection properties.

1. Click the **Start** button and click **Control Panel**.
2. Click **Printers and Other Hardware**, click **Phone and Modem Options**, click the **Dialing Rules** tab, and then click **Edit...**
3. In the **Edit Location** window, ensure that **To disable call waiting, dial:** is checked, and then select the proper code as listed in your telephone directory.
4. Click **Apply** and click **OK**.
5. Close the **Phone and Modems Options** window.
6. Close the **Control Panel** window.

Verify that the modem is communicating with Windows

1. Click the **Start** button and click **Control Panel**.
2. Click **Printers and Other Hardware**.
3. Click **Phone and Modem Options**.
4. Click the **Modems** tab.
5. Click the COM port for your modem.
6. Click **Properties**, click the **Diagnostics** tab, and then click **Query Modem** to verify that the modem is communicating with Windows.

If all commands receive responses, the modem is operating properly.

Scanner Problems

Check the power cable connection—

Ensure that the scanner power cable is firmly connected to a working electrical power source and that the scanner is turned on.

Check the scanner cable connection—

Ensure that the scanner cable is firmly connected to the computer and to the scanner.

Unlock the scanner—

Ensure that your scanner is unlocked if it has a locking tab or button.

Reinstall the scanner driver—

See the scanner documentation for instructions.

Touch Pad or Mouse Problems

Check the touch pad settings

1. Click the **Start** button, click **Control Panel**, and then click **Printers and Other Hardware**.
2. Click **Mouse**.
3. Try adjusting the settings.

Check the mouse cable—

Shut down the computer. Disconnect the mouse cable and check it for damage. For PS/2 cables, check the cable connector for bent or broken pins. Firmly reconnect the cable.

If you are using a mouse extension cable, disconnect it and connect the mouse directly to the computer.

To verify that the problem is with the mouse, check the touch pad

1. Turn off the computer.
2. Disconnect the mouse.
3. Turn on the computer.
4. At the Windows desktop, use the touch pad to move the cursor around, select an icon, and open it.

If the touch pad operates correctly, the mouse may be defective.

Reinstall the touch pad driver—

See "[Reinstalling Drivers and Utilities](#)."

External Keyboard Problems



HINT: When you attach an external keyboard, the integrated keyboard remains fully functional.

Check the keyboard cable—

Shut down the computer. Disconnect the keyboard cable and check it for damage. For PS/2 cables, check the cable connector for bent or broken pins. Firmly reconnect the cable.

If you are using a keyboard extension cable, disconnect it and connect the keyboard directly to the computer.

Check the external keyboard

1. Turn off the computer, wait 1 minute, and turn it on again.
2. Verify that the numbers, capitals, and scroll lock lights on the keyboard blink during the boot routine.
3. From the Windows® desktop, click the **Start** button, point to **Programs**, point to **Accessories**, and click **Notepad**.
4. Type some characters on the external keyboard and verify that they appear on the display.

If you cannot verify these steps, you may have a defective external keyboard.

To verify that the problem is with the external keyboard, check the integrated keyboard

1. Turn off the computer.
2. Disconnect the external keyboard.
3. Turn on the computer.
4. From the Windows desktop, click the **Start** button, point to **Programs**, point to **Accessories**, and click **Notepad**.
5. Type some characters on the integrated keyboard and verify that they appear on the display.

If the characters appear now but did not with the external keyboard, you may have a defective external keyboard. Contact Dell (see "Contacting Dell" in the Dell *Owner's Manual* that came with your computer).

Unexpected Characters



Disable the numeric keypad— Press  to disable the numeric keypad if numbers are displayed instead of letters. Verify that the numbers lock light is not lit.

Drive Problems



HINT: For information on saving files to a floppy disk, see the *Tell Me How* help file. To access the help file, see "[Accessing Help](#)."

If you cannot save a file to a floppy disk drive

Ensure that Windows® recognizes the drive—

Click the **Start** button and click **My Computer**. If the drive is not listed, perform a full scan with your antivirus software to check for and remove viruses. Viruses can sometimes prevent Windows from recognizing the drive. Insert a bootable disk and restart the computer. Verify that the  light is blinking, indicating normal operation.

Ensure that the disk is not write-protected— You cannot save data to a write-protected disk.

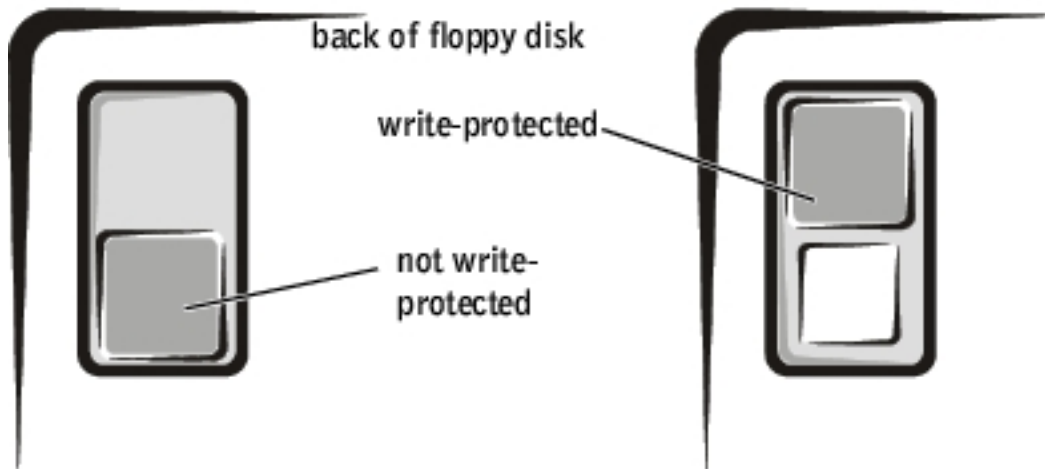

Try another floppy disk— Insert another disk to eliminate the possibility that the original disk is defective.

Reinstall the drive

1. Save and close any open files, exit any open programs, and shut down the computer.
2. *If the drive is installed in the module bay, remove the drive.*

If the drive is a fixed drive, review "[Check the drive for errors.](#)"

3. Reinstall the drive.
4. Turn on the computer.

Clean the drive— See "Cleaning Your Computer" in the *Tell Me How* help file for instructions. To access the help file, see "[Accessing Help.](#)"

If you cannot play a CD, CD-RW, or DVD

 **HINT:** Because of different worldwide file types, not all DVD titles work in all DVD drives.

High-speed CD drive vibration is normal and may cause noise. This noise does not indicate a defect with the drive or the CD.

Ensure that Windows® recognizes the drive— Click the **Start** button and click **My Computer**. If the drive is not listed, perform a full scan with your antivirus software to check for and remove viruses. Viruses can sometimes prevent Windows from recognizing the drive. Insert a bootable disk and restart the computer. Verify that the  light is blinking, indicating normal operation.

Try another disc— Insert another disc to eliminate the possibility that the original disc is defective.

Adjust the Windows volume control— Double-click the speaker icon in the lower-right corner of your screen. Ensure that the volume is turned up and that the sound is not muted.

Identify the disc that is not playing— If you have one CD, CD-RW, or DVD in the fixed optical drive device and one in the module bay device:

1. Click the **Start** button and click **My Computer**.
2. Double-click the drive letter of the device that you are verifying.

Reinstall the drive

1. Save and close any open files, exit any open programs, and shut down the computer.
2. *If the drive is installed in the module bay, remove the drive.*

If the drive is a fixed drive, review "[Check the drive for errors](#)."

3. Reinstall the drive.
4. Turn on the computer.

Clean the drive or disc— See "Cleaning Your Computer" in the *Tell Me How* help file for instructions. To access the help file, see "[Accessing Help](#)."

Check the drive for errors

If the drive is a fixed optical drive:

1. Remove the hard drive and floppy drive.
2. Insert the *Drivers and Utilities* CD for your computer and turn on the computer.
3. Verify that the  light is blinking, indicating normal operation.

If you cannot eject the CD, CD-RW, or DVD drive tray

1. Ensure that the computer is turned off.
2. Straighten a paper clip and insert one end into the eject hole at the front of the drive; push firmly until the tray is partially ejected.
3. Gently pull out the tray until it stops.

If you hear an unfamiliar scraping or grinding sound

- Ensure that the sound is not caused by the program that is running.
- Ensure that the disk or disc is inserted properly.

If the CD-RW drive stops writing

Disable standby mode in Windows before writing to a CD-RW— Search for the keyword *standby* in the Windows Help and Support Center. To access the help file, see "[Accessing Help](#)."

Change the write speed to a slower rate— See the help files for your CD creation software.

Exit all other open programs— Exiting all other open programs before writing to the CD-RW may alleviate the problem.

If you have problems with a hard drive

Allow the computer to cool before turning it on— A hot hard drive may prevent the operating system from starting. Try allowing the computer to return to room temperature before turning it on.

Check the drive for errors

1. Click the **Start** button and click **My Computer**.
2. Right-click the drive letter (local disk) that you want to scan for errors, and then click **Properties**.
3. Click the **Tools** tab.
4. Under **Error-checking**, click **Check Now**.
5. Click **Start**.

PC Card Problems

Check the PC Card—

Ensure that the PC Card is properly inserted into the connector.

Ensure that the card is recognized by Windows®—

Double-click the **Unplug or Eject Hardware** icon in the Windows taskbar. Ensure that the card is listed.

If you have problems with a Dell-provided PC Card—

Contact Dell (see "Contacting Dell" in the Dell *Owner's Manual* that came with your computer).

If you have problems with a PC Card not provided by Dell—

Contact the PC Card manufacturer.

Network Problems

Check the network cable connector—

Ensure that the network cable connector is firmly connected to the connector on the computer and the network wall jack.

Check the network lights on the network connector—

A green or red-orange status light indicates that the network connection is active. If this status light is not lit, try replacing the network cable. The amber light indicates that the network adapter driver is loaded and the adapter is detecting activity.

Restart the computer—

Try to log on to the network again.

Contact your network administrator—

Verify that your network settings are correct and that the network is functioning.

Error Messages

If the message is not listed, see the documentation for the operating system or the program that was running at the time the message appeared.

The file being copied is too large for the destination drive—

The file that you are trying to copy is too large to fit on the disk, or the disk is too full. Try copying the file to a different disk or use a larger capacity disk.

A filename cannot contain any of the following characters: \ / : * ?

" < > | —

Do not use these characters in filenames.

Insert bootable media—

The operating system is trying to boot to a nonbootable floppy disk or CD. Insert a bootable floppy disk or CD.

Non-system disk or disk error—

A floppy disk is in the floppy drive. Remove the floppy disk and restart the computer.

Not enough memory or resources. Exit some programs and try again—

You have too many programs open. Close all windows and open the program that you want to use.

Operating system not found—

Contact Dell (see "Contacting Dell" in the *Dell Owner's Manual* that came with your computer).

A required .DLL file was not found—

The program that you are trying to open is missing an essential file. Remove and then reinstall the program.

1. Click the **Start** button.
2. Click **Control Panel**.
3. Click **Add or Remove Programs**.
4. Select the program you want to remove.
5. Click the **Change or Remove Program** icon.
6. See the program documentation for installation instructions.

x:\ is not accessible. The device is not ready—

Insert a disk into the drive and try again.

General Program Problems

A program crashes



-  **HINT:** Software usually includes installation instructions in its documentation or on a floppy disk or CD.

See the software documentation—

Many software manufacturers maintain websites with information that may help you solve the problem. Ensure that you properly installed and configured the program. Reinstall the program if necessary.

A program stops responding

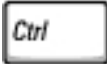
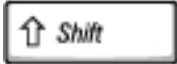
End the program

1. Simultaneously press   .
2. Click the **Applications** tab, and then select the program that is no longer responding.
3. Click **End Task**.

A solid blue screen appears

Turn the computer off—

If the computer does not respond to a keystroke or a proper shutdown, press the power button until the computer turns off. Press the power button again to restart the computer. The solid blue screen appears because you were not able to perform a proper Windows® shutdown. ScanDisk automatically runs during the start-up process. Follow the instructions on the screen.

Error messages appear

Review "Error Messages"—

Look up the message and take the appropriate action. See "[Check the drive for errors](#)" and the software documentation.

E-Mail Problems

Ensure that you are connected to the Internet—

With the Outlook Express e-mail program open, click **File**. If **Work Offline** has a check mark next to it, click the check mark to remove it and connect to the Internet.

Resolving Other Technical Problems

Go to the Dell Support website—

Go to **support.dell.com** for help with general usage, installation, and troubleshooting questions.

E-mail Dell—

Go to **support.dell.com** and then click **E-Mail Dell** in the **Communicate** list. Send an e-mail message to Dell about your problem; you can expect to receive an e-mail message from Dell within hours.

Contact Dell—

If you cannot solve your problem using the Dell™ support website or e-mail service, contact Dell for technical assistance (see "Contacting Dell" in the *Dell Owner's Manual* that came with your computer).

If Your Computer Gets Wet



CAUTION: Perform this procedure only after you are certain that it is safe to do so. If the computer is connected to an electrical outlet, Dell recommends that you turn off AC power at the circuit breaker before attempting to remove the power cables from the electrical outlet. Use the utmost caution when removing wet cables from a live power source.

1. Turn off the computer, disconnect the AC adapter from the computer, and then disconnect the AC adapter from the electrical outlet.
2. Turn off any attached external devices, and disconnect them from their power sources and then from the computer.
3. Ground yourself by touching one of the metal connectors on the back of the computer.
4. Remove the module bay device and any installed PC Cards, and place them in a safe place to dry.
5. Remove the battery.
6. Wipe off the battery and put it in a safe place to dry.
7. Remove the hard drive.
8. Remove the memory module(s).
9. Open the display and place the computer right-side up across two books or similar props to let air circulate all around it. Let the computer dry for at least 24 hours in a dry area at room temperature.



NOTICE: Do not use artificial means, such as a hair dryer or a fan, to speed the drying process.



CAUTION: To help prevent electrical shock, verify that the computer is thoroughly dry before continuing with the rest of this procedure.

10. Ground yourself by touching one of the metal connectors on the back of the computer.

11. Replace the memory module(s), the memory module cover, and the screw(s).
12. Replace the hard drive.
13. Replace the module bay device and any PC Cards you removed.
14. Replace the battery.
15. Turn on the computer and verify that it is working properly.

If the computer does not start, or if you cannot identify the damaged components, contact Dell (see "Contacting Dell" in the Dell *Owner's Manual* that came with your computer).

If You Drop or Damage Your Computer

1. Save and close any open files, exit any open programs, and shut down the computer.
2. Disconnect the AC adapter from the computer and from the electrical outlet.
3. Turn off any attached external devices, and disconnect them from their power sources and then from the computer.
4. Remove and reinstall the battery.
5. Turn on the computer.

If the computer does not start, or if you cannot identify the damaged components, contact Dell (see "Contacting Dell" in the Dell *Owner's Manual* that came with your computer).

[Back to Contents Page](#)

[Back to Contents Page](#)

Using Dell Diagnostics

Dell™ Inspiron™ 8200

- [When to Use the Dell Diagnostics](#)
 - [Features of the Dell Diagnostics](#)
 - [Starting the Dell Diagnostics](#)
 - [Advanced Testing](#)
 - [Confirming the System Configuration Information](#)
-

When to Use the Dell Diagnostics

Whenever a major component or device in your computer does not function properly, you may have a component failure. If you are experiencing a problem with your computer, Dell recommends that you perform the checks in "[Solving Problems](#)" and run the [Dell Diagnostics](#) *before* you call Dell for technical assistance.

As long as the microprocessor and the display, keyboard, and CD or DVD drive are working, you can use the Dell Diagnostics. Running the Dell Diagnostics may help you to resolve the problem yourself quickly without having to contact Dell for assistance.

If you are experienced with computers and know what component(s) you need to test, simply select the appropriate diagnostic test group(s) or subtest(s). If you are unsure about how to begin diagnosing a problem, see "[Starting the Dell Diagnostics](#)" and "[Advanced Testing](#)."

Features of the Dell Diagnostics

The Dell Diagnostics helps you check your computer's hardware without any additional equipment and without destroying any data. By using the diagnostics, you can have confidence in your computer's operation. And if you find a problem you cannot solve

by yourself, the diagnostic tests can provide you with important information you will need when talking to Dell's service and support personnel. If you are experiencing a problem with your computer, Dell recommends that you perform the checks in "[Solving Problems](#)" and run the Dell Diagnostics *before* you call Dell for technical assistance.

 **NOTICE:** Use the Dell Diagnostics to test only your Dell™ computer. Using this program with other computers may cause incorrect computer responses or result in error messages.

The diagnostic test groups or subtests also have these helpful features:

- Options that let you perform quick checks or extensive tests on one or all devices
- An option that allows you to choose the number of times a test group or subtest is repeated
- The ability to display test results or to save them in a file
- Options to temporarily suspend testing if an error is detected, or to terminate testing when an adjustable error limit is reached
- Extensive online Help screens that describe the tests and how to run them
- Status messages that inform you whether test groups or subtests were completed successfully
- Error messages that appear if any problems are detected



Starting the Dell Diagnostics

 **HINT:** Dell recommends that you print these procedures before you begin.



Before you can start the Dell Diagnostics you need to reset your boot sequence and boot from the *Drivers and Utilities* CD for your computer.



HINT: You can only boot from a CD, CD-RW, or DVD drive installed as a fixed drive. You cannot boot from a drive installed in the module bay.

1. Turn off the computer.
2. If the computer is docked, undock the computer.
3. Ensure that the computer is connected to an electrical outlet.
4. Turn on the computer with the *Drivers and Utilities* CD in the CD, CD-RW, or DVD drive.
5. Press  to enter the system setup program as soon as the Dell logo screen appears, and before the Microsoft® Windows® logo screen appears.
6. Select the **Boot Order** page of the system setup program. Make a note of the device currently set as the first (top) boot device, and then set the first three devices in the boot sequence in the following order:
 - **Diskette Drive**
 - **CD/DVD/CD-RW drive**
 - **Internal HDD**
7. Save your changes and press  to exit the system setup program and restart the computer to boot from the CD.

The computer starts and automatically begins to run the Dell Diagnostics.

8. When you have completed running diagnostics, remove the *Drivers and Utilities* CD.
9. When the computer restarts, press  as soon as the Dell logo screen appears, and before the Windows logo screen appears.
10. In the system setup program, select the **Boot Order** page and reset the boot sequence to the original order.
11. Press  to exit the system setup program and restart Microsoft Windows.

12. Remove the CD from the CD, CD-RW, or DVD drive.

When you start the diagnostics, the Dell logo screen appears, followed by a message telling you that the diagnostics is loading. After the diagnostics loads, the **Diagnostics Menu** appears.

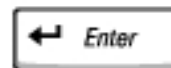

To select an option from this menu, highlight the option and press , or press the key that corresponds to the highlighted letter in the option you choose.

Diagnostics Menu

Option	Function
Test All Devices	Performs extensive diagnostic tests or quick diagnostic tests on all devices.
Test One Device	Performs extensive diagnostic tests or quick diagnostic tests on one device after you select it from a list of device groups. After you select Test One Device , press  for more information about a test.
Advanced Testing	Allows you to modify the parameters of a test and select a group of tests to perform. You can access online Help for more information about Advanced Testing .
Information and Results	Provides test results, test errors, version numbers of the subtests used by the Dell Diagnostics, and additional help on the Dell Diagnostics.
Program Options	Allows you to change the settings of the Dell Diagnostics.
Exit to MS-DOS	Exits to the MS-DOS® prompt.

For a quick check of your computer, select **Quick Tests** from the **Test All Devices** or **Test One Device** option. **Quick Tests** runs only the subtests that do not require user interaction and that do not take a long time to run. Dell recommends that you choose **Quick Tests** first to increase the odds of tracing the source of the problem quickly.

For a thorough check of your computer, select **Extended Tests** from the **Test All Devices** option.

To check a particular area of your computer, select **Extended Tests** from the **Test One Device** option, or select the **Advanced Testing** option to customize your test(s).

Advanced Testing

When you select **Advanced Testing** from the **Diagnostics Menu**, the following screen appears, listing the diagnostic test device groups and devices of the selected device group, and it allows you to select categories from a menu. Press the arrow

keys or   to navigate the screen.

Advanced Testing Main Screen

 **HINT:** The test groups reflect the configuration of your computer.

Information in the **Advanced Testing** screen is presented as follows:

- On the left side of the screen, the **Device Groups** area lists the diagnostic test groups in the order they will run if you select **All** from the **Run tests** menu category. Press the up- or down-arrow key to highlight a test device group.
- On the right side of the screen, the **Devices for Highlighted Group** area lists the computer's currently detected hardware and some of the relevant settings.
- Two lines at the bottom of the screen make up the menu area (see "[Advanced Testing Help Menu](#)"). The first line lists the categories you can select; press the left- or right-arrow key to highlight a menu category. The second line gives information about the category currently highlighted.

Advanced Testing Help Menu

For more information on using the **Advanced Testing** option:

1. Press  .

2. Highlight the **Help** category and press  , or press the key that corresponds to the highlighted letter in the category you choose.

Advanced Testing Help Categories

Help Category	Description
Menu	Provides descriptions of the main menu screen area, the Device Groups, and the different diagnostic menus and commands and instructions on how to use them.
Keys	Explains the functions of the all of the keystrokes that can be used in Dell Diagnostics.
Device Group	Describes the test group that is presently highlighted in the Device Groups list on the main menu screen. It also provides reasoning for using some tests.
Device	<p>Describes the function and purpose of the highlighted device in the Device Groups. For example, the following information appears when you select the Device Help category for Diskette in the Device Groups list:</p> <p>Diskette</p> <p>Drive A</p> <p>The diskette disk drive device reads and writes data to and from diskettes. Diskettes are flexible recording media, sometimes contained in hard shells. Diskette recording capacities are small and access times are slow relative to hard disk drives, but they provide a convenient means of storing and transferring data.</p>

Test	<p>Provides a thorough explanation of the test procedure of each highlighted test group subtest. An example of the Diskette floppy drive Seek Test is as follows:</p> <p>Diskette</p> <p>Drive A - floppy drive Seek Test</p> <p>This test verifies the drive's ability to position its read/write heads. The test operates in two passes: first, seeking from the beginning to ending cylinders inclusively, and second, seeking alternately from the beginning to ending cylinders with convergence towards the middle.</p>
Versions	Lists the version numbers of the subtests that are used by the Dell Diagnostics.

Confirming the System Configuration Information

When you boot your computer from your *Drivers and Utilities CD*, the diagnostics checks your system configuration information and displays it in the **Device Groups** area on the main screen.

The following sources supply this configuration information for the diagnostics:

- The system configuration information settings (stored in NVRAM) that you selected while using the system setup program
- Identification tests of the microprocessor, the video controller, the keyboard controller, and other key components
- BIOS configuration information temporarily saved in RAM

Do not be concerned if the **Device Groups** area does not list the names of all the components or devices you know are part of your computer. For example, you may not see a printer listed, although you know one is attached to your computer. Instead, the printer is listed as a parallel port. The computer recognizes the parallel port as

LPT1, which is an address that tells the computer where to send outgoing information and where to look for incoming information. Because your printer is a parallel communications device, the computer recognizes the printer by its LPT1 address and identifies it as a parallel port. You can test your printer connection in the **Parallel Ports** tests.

[Back to Contents Page](#)

[Back to Contents Page](#)

Reinstalling Drivers and Utilities

Dell™ Inspiron™ 8200

- [Reinstalling Drivers and Utilities](#)
 - [Resolving Software and Hardware Incompatibilities](#)
 - [Using Microsoft® Windows® System Restore](#)
-

Reinstalling Drivers and Utilities

Dell ships your computer to you with required drivers and utilities already installed—no further installation or configuration is needed.

- ➔ **NOTICE:** The *Drivers and Utilities* CD may contain drivers for operating systems that are not on your computer. Ensure that you are installing software appropriate for your operating system.

To reinstall drivers for optional devices such as wireless communications, DVD drives, and ZIP drives, you may need the CD and documentation that came with those devices.

To reinstall a driver or utility from your *Drivers and Utilities* CD:

- ➔ **NOTICE:** The Dell Support website, support.dell.com, and the *Drivers and Utilities* CD provide approved drivers for Dell™ computers. If you install drivers from other sources, your computer might not work correctly.

1. Save and close any open files, and exit any open programs.
2. Insert the *Drivers and Utilities* CD.

In most cases, the CD starts running automatically. If it does not, start Microsoft® Windows® Explorer, click your CD drive directory to display the CD contents, and then double-click the **autocd.exe** file. The first time that you run

the CD, it might prompt you to install setup files. Click **OK**, and follow the instructions on the screen to continue.

3. From the **Language** pull-down menu in the toolbar, select your preferred language for the driver or utility (if available).

A welcome screen appears.

4. Click **Next**. The CD automatically scans your hardware to detect some drivers used by your computer.

After the CD completes the hardware scan, you can also detect other drivers and utilities. Under **Search Criteria**, select the appropriate categories from the **System Model**, **Operating System**, and **Topic** pull-down menus.

A link or links appear(s) for the specific drivers and utilities used by your computer.

5. Click the link of a specific driver or utility to display information about the driver or utility that you want to install.
6. Click the **Install** button (if present) to begin installing the driver or utility. At the welcome screen, follow the screen prompts to complete the installation.

If no **Install** button is present, automatic installation is not an option. For installation instructions, either see the appropriate instructions in the following subsections, or click **Extract**, follow the extracting instructions, and read the readme file.

If instructed to navigate to the driver files, click the CD directory on the driver information window to display the files associated with that driver.

Manually Reinstalling Drivers for Windows XP



HINT: If you are reinstalling an infrared device driver, you must first enable the infrared sensor in the system setup program before continuing with the driver installation.

1. After extracting the driver files to your hard drive as described previously, click

- the **Start** button, point to **Settings**, and click **Control Panel**.
- Click the **Start** button and right-click **My Computer**.
- Click **Properties**.
- Click the **Hardware** tab and click **Device Manager**.
- Double-click the type of device for which you are installing the driver (for example, **Modems** or **Infrared devices**).
- Double-click the name of the device for which you are installing the driver.
- Click the **Driver** tab, and then click **Update Driver**.
- Select **Install from a list or specific location (Advanced)**, and then click **Next**.
- Click **Browse**, and browse to the location to which you previously extracted the driver files.
- When the name of the appropriate driver appears, click **Next**.
- Click **Finish** and restart your computer.

Using Windows XP Device Driver Rollback

If you install a new device driver that causes system instability, you can use Windows XP Device Driver Rollback to replace the new device driver with the previously installed version of the device driver. If you cannot reinstall your previous driver by using Device Driver Rollback, then use System Restore (see "[Using Microsoft® Windows® System Restore](#)") to return your operating system to its previous operating state before you installed the new device driver. To use Device Driver Rollback:

- Click the **Start** button and right-click **My Computer**.
- Click **Properties**.
- Click the **Hardware** tab and click **Device Manager**.
- In the **Device Manager** window, right-click the device for which the new driver was installed and then click **Properties**.
- Click the **Drivers** tab.

6. Click **Roll Back Driver**.

Resolving Software and Hardware Incompatibilities

In the Microsoft® Windows® XP operating system, IRQ conflicts occur if a device either is not detected during the operating system setup or is detected but incorrectly configured. To check for IRQ conflicts on your computer:

1. Click the **Start** button and click **Control Panel**.
2. Click **Performance and Maintenance** and click **System**.
3. Click the **Hardware** tab and click **Device Manager**.
4. In the **Device Manager** list, check for conflicts with the other devices.

Conflicts are indicated by a yellow exclamation point (!) beside the conflicting device or a red X if the device has been disabled.

5. Double-click any conflicting device listed to bring up the **Properties** window so that you can determine what needs to be reconfigured or removed from the Device Manager.
6. Resolve these conflicts before checking specific devices.
7. Double-click the malfunctioning device type in the **Device Manager** list.
8. Double-click the icon for the specific device in the expanded list.

The **Properties** window appears.

If an IRQ conflict exists, the **Device status** area in the **Properties** window reports what other devices are sharing the device's IRQ.

9. Resolve any IRQ conflicts.

You can also use the Windows XP Hardware Troubleshooter. To use the troubleshooter, click the **Start** button and click **Help and Support**. Type *hardware troubleshooter* in the **Search** field, and then click the arrow to start the search. Click **Hardware Troubleshooter** in the **Search Results** list. In the **Hardware Troubleshooter** list, click **I need to resolve a hardware conflict on my computer**, and then click **Next**.

Using Microsoft® Windows® System Restore

The Microsoft® Windows® XP operating system provides a System Restore feature that allows you to return your computer to an earlier operating state if changes to the computer's hardware or software (including new hardware or program installations) or system settings, have left the computer in an undesirable operating state. You can also undo the last *system restore*.

System Restore automatically creates system checkpoints. You can also manually create your own checkpoints by creating *restore points*. To limit the amount of hard disk space used, older restore points are automatically purged.

To resolve an operating system problem, you can use System Restore from Safe Mode or Normal Mode to return your computer to an earlier operating state.

System Restore does not cause you to lose personal files stored in the **My Documents** folder, data files, or e-mail messages after restoring the computer to an earlier time. If you restore the computer to an operating state that existed before you installed a program, the program's data files are not lost, but you must reinstall the actual program again.



NOTICE: It is important to make regular backups of your data files. System Restore does not monitor changes to or recover your data files. If the original data on the hard disk is accidentally erased or overwritten, or if it becomes inaccessible because of a hard disk malfunction, use your backup files to recover the lost or damaged data.

System Restore is enabled on your new computer. However, if you reinstall Windows XP with less than 200 MB of free hard-disk space available, System Restore is automatically disabled. Before you use System Restore, confirm that it is enabled:

1. Click the **Start** button and click **Control Panel**.
2. Click the **Performance and Maintenance**.
3. Click **System**.
4. Click the **System Restore** tab.
5. Ensure that **Turn off System Restore** is not checked.

Creating a Restore Point

Using the System Restore Wizard

In Windows XP you can either use the System Restore Wizard or manually create a restore point. To use the System Restore Wizard, click the **Start** button, click **Help and Support**, click **System Restore**, and then follow the instructions in the **System Restore Wizard** window. You can also create and name a restore point if you are logged on as the computer administrator or a user with administrator rights.

Manually Creating a Restore Point

1. Click the **Start** button, point to **All Programs**—> **Accessories**—> **System Tools**, and then click **System Restore**.
2. Click **Create a restore point**.
3. Click **Next**.
4. Type a name for the new restore point in the **Restore point description** field.

The present date and time are automatically added to the description of the new restore point.

5. Click **Create**.
6. Click **OK**.

Restoring the Computer to an Earlier Operating State

If problems occur after installing a device driver, first try using Device Driver Rollback (see "[Using Windows XP Device Driver Rollback](#)"). If Device Driver Rollback does not resolve the problem, then use System Restore.

 **NOTICE:** Before restoring the computer to an earlier operating state, save and close all open files and exit all open programs. Do not alter, open, or delete any files or programs until the system restoration is complete.

1. Click the **Start** button, point to **All Programs**—> **Accessories**—> **System Tools**, and then click **System Restore**.
2. Ensure that **Restore my computer to an earlier time** is selected and click **Next**.
3. Click a calendar date to which you want to restore your computer.

The **Select a Restore Point** screen provides a calendar that allows you to see and select restore points. All calendar dates with available restore points appear in bold.

4. Select a restore point and click **Next**.

If a calendar date has only one restore point, then that restore point is automatically selected. If two or more restore points are available, click the restore point that you want to use.

 **NOTICE:** Save and close all open files and exit all open programs. Do not alter, open, or delete any files or programs until the system restoration is complete.

5. Click **Next**.

The **Restoration Complete** screen appears after System Restore finishes collecting data, and then the computer automatically restarts.

6. After the computer restarts, click **OK**.

To change the restore point, you can either repeat the steps using a different restore point, or you can undo the restoration.

Undoing the Last System Restore

 **NOTICE:** Save and close all open files and exit all open programs. Do not alter, open, or delete any files or programs until the system restoration is complete.

1. Click the **Start** button, point to **All Programs**—> **Accessories**—> **System Tools**, and then click **System Restore**.
2. Select **Undo my last restoration** and click **Next**.

 **NOTICE:** Save and close all open files and exit all open programs. Do not alter, open, or delete any files or programs until the system restoration is complete.

3. Click **Next**.
4. The **System Restore** screen appears, and then the computer automatically restarts.
5. After the computer restarts, click **OK**.

[Back to Contents Page](#)

[Back to Contents Page](#)



Reinstalling Microsoft® Windows® XP

Dell™ Inspiron™ 8200

Before reinstalling the Windows XP operating system to correct a problem, try correcting the problem by using Windows System Restore (see "[Using Microsoft® Windows® System Restore](#)").

 **NOTICE:** The *Operating System* CD provides options for reinstalling the Windows XP operating system. The options can potentially overwrite files installed by Dell and possibly affect programs installed on your hard drive. Therefore, Dell does not recommend that you reinstall your operating system unless instructed to do so by a Dell technical support representative.

 **HINT:** The CD that you need to place in your CD or DVD drive is titled *Operating System*.

1. Insert the *Operating System* CD.
2. Shut down the Dell™ computer, and then turn on the computer.
3. Press any key when the Press any key to boot from CD message appears on the screen.
4. When the **Windows XP Setup** screen appears, press  to select **To set up Windows now**.
5. Read the information in the **License Agreement** window, and then press  to agree with the license information.
6. If your computer already has Windows XP installed and you want to recover your current Windows XP data, type `r` to select the repair option, and then go to [step 15](#).

If you want to install a new copy of Windows XP, press  to select the fresh



copy option and then press  to select the highlighted partition (recommended). Then follow the instructions on the screen.

7. The **Windows XP Setup** screen appears and Windows XP begins to copy files and install the device drivers. The computer automatically restarts multiple times before it requires additional input.
8. When the **Welcome to Microsoft** screen appears, click the green arrow icon at the bottom of the screen to continue. Then follow the instructions on the screen to finish the installation.
9. When the **Regional Settings** screen appears, select the settings for your locale, and then click **Next**.
10. Enter your name and organization in the **Personalize Your Software** screen, and then click **Next**.
11. *If you are reinstalling Windows XP Home Edition*, enter a name for your computer when the **Computer Name** window appears, and then click **Next**.

If you are reinstalling Windows XP Professional, enter a name for your computer and a password when the **Computer Name and Administrator Password** window appears, and then click **Next**.

12. If you have a modem installed, the **Modem Dialing Information** screen appears. Enter the requested information and click **Next**.
13. Enter the date, time, and time zone in the **Date and Time Settings** window and click **Next**.
14. If your computer has a network adapter, select the appropriate network settings. If your computer does not have a network adapter, you do not see this option.

Windows XP begins to install its components and configure the computer. The computer automatically restarts.

15. When the **Welcome to Microsoft** screen appears, click the green arrow icon at the bottom of the screen to continue. Then follow the instructions on the screen to complete the installation.
16. Remove the CD from the drive.

17. Reinstall the appropriate drivers (see "[Reinstalling Drivers and Utilities](#)").
18. Reinstall your virus protection software.

Enabling Hibernate Mode

1. Click the **Start** button, point to **Settings**, and then click **Control Panel**.
2. Double-click the **Power Management** icon.
3. Click the **Hibernate** tab.
4. Ensure that **Enable hibernate support** is selected, and click **Apply**.
5. Click **OK** to close the Control Panel.

[Back to Contents Page](#)

[Back to Contents Page](#)

System Setup Program

Dell™ Inspiron™ 8200

- [System Setup Overview](#)
 - [Viewing the System Setup Screens](#)
 - [System Setup Screens](#)
 - [Commonly Used Options](#)
-

System Setup Overview



HINT: Your operating system may automatically configure most of the options available in the system setup program, thus overriding options that you set through the system setup program. (An exception is the External Hot Key option, which you can disable or enable only through the system setup program.) For more information on configuring features for your operating system, see your Microsoft® Windows® Help and Support Center.

You can use the system setup program as follows:

- To set or change user-selectable features—for example, your password
- To verify information about your computer's current configuration, such as the amount of system memory

After you set up your computer, run the system setup program to familiarize yourself with your system configuration information and optional settings. Dell recommends that you write down the information for future reference.



The system setup program contains the standard settings for your computer.

-  **NOTICE:** Unless you are an expert computer user or are directed to do so by Dell technical support, do not change the settings for this program. Certain changes might make your computer work incorrectly.
-

Viewing the System Setup Screens

1. Turn on (or restart) your computer.
2. When the Dell™ logo appears, press  immediately.

If you wait too long and the Windows® logo appears, continue to wait until you see the Windows desktop. Then shut down your computer and try again.

Depending on your computer, you may also be able to enter the system setup program by pressing   at any time while the computer is running.

System Setup Screens

-  **HINT:** To see information about a specific item on a system setup screen, highlight the item and refer to the **Help** area on the screen.

The system setup screens display the current setup information and settings for your computer. Each screen is laid out with the system setup options listed at the left. To the right of each option is a field that displays the setting or value for that option. You can change settings that appear as white type on the screen. Options or values that you cannot change (because they are determined by the computer) appear less bright.

A box in the upper-right corner of the screen displays help information for the currently highlighted option; a box in the lower-right corner displays information about the computer. System setup key functions are listed across the bottom of the screen.

The screens display such information as:

- System configuration
 - Boot (start-up) configuration and docking-device configuration settings
 - Basic device configuration settings
 - Battery charge status
 - Power management settings
 - System security and hard-drive password settings
-

Commonly Used Options



HINT: Certain options require that you reboot the computer for new settings to take effect.

- To enable or disable a device, highlight the item and press  . Enabled items appear as white and display a small triangle to the left; disabled items appear blue or dimmed without a triangle.

Changing Printer Modes

Set the **Parallel Mode** option according to the type of printer or device connected to the parallel connector. To determine the correct mode to use, see the documentation that came with the device.

Setting **Parallel Mode** to **Disabled** disables the parallel port and the port's LPT address, freeing its interrupt for another device to use.

Changing COM Ports

Serial Port allows you to map the serial port COM address or disable the serial port

and its address, freeing that interrupt for another device to use.

[Back to Contents Page](#)

[Back to Contents Page](#)

Specifications

Dell™ Inspiron™ 8200

- [System Information](#)
- [PC Card](#)
- [Memory](#)
- [Ports and Connectors](#)
- [Communications](#)
- [Video](#)
- [Audio](#)
- [Display](#)
- [Keyboard](#)
- [Touch Pad](#)
- [Track Stick](#)
- [Battery](#)
- [AC Adapter](#)
- [Physical](#)
- [Environmental](#)

System Information

System chip set	Intel® 845MP
Data bus width	64 bits
Microprocessor address bus width	32 bits
Graphics bus	32-bit AGP 4X
PCI bus	33 MHz

PC Card	
CardBus controller	Texas Instruments PCI 4450/4451 CardBus controller
PC Card connector	two (supports two Type I or Type II cards or one Type III card)
Cards supported	3.3 V and 5 V
PC Card connector size	68 pins
Data width (maximum)	PCMCIA 16 bits CardBus 32 bits

Memory	
Architecture	PC2100 DDR
Memory module connector	two user-accessible SODIMM sockets
Memory module capacities	128, 256, and 512 MB
Memory type	DDR SDRAM
Standard memory	128 MB
Maximum memory	1024 MB
Memory access time: clock speed	266 MHz

Ports and Connectors	
Serial	9-pin connector; 16550C-compatible, 16-byte buffer connector
Parallel	25-hole connector; unidirectional, bidirectional, or ECP

Video	15-hole VGA connector
Audio	stereo (line-in) mini connector; microphone mini connector, stereo headphone/speakers (line-out) mini connector
PS/2 keyboard/mouse	6-pin mini-DIN connector
USB	two 4-pin USB-compliant connector
Infrared	sensor compatible with IrDA Standard 1.1 (Fast IR) and IrDA Standard 1.0 (Slow IR)
Docking	200-pin connector for a Dell™ docking device
S-video TV-out	7-pin mini-DIN connector for S-video, composite video, and S/PDIF (TV/digital audio adapter cable supports composite video and S/PDIF)
Modem	RJ-11 port
Network adapter	RJ-45 port
IEEE 1394	4-pin serial connector

Communications	
Modem:	
Type	integrated v.92 56K
Controller	softmodem
Interface	internal AC 97 bus
Network adapter	10/100 Ethernet LAN on system board
Wireless	internal Mini PCI Wi-Fi (802.11b) wireless support

Video	
Video type	128-bit hardware accelerated
Data bus	4X AGP
Video controller	NVIDIA GeForce4 440 Go™ ATI Mobility™ RADEON™ 9000
Video memory	NVIDIA GeForce4 440 Go™ ATI Mobility™ RADEON™ 9000
LCD interface	LVDS
TV support	NTSC or PAL in S-video and composite modes

Audio	
Audio type	AC97 (Soft Audio)
Audio controller	Cirrus Logic/Crystal CS4205
Stereo conversion	18-bit analog-to-digital 20-bit digital-to-analog
Interfaces:	
Internal	AC 97
External	microphone-in connector, stereo headphones/speakers connector, and stereo line-in connector
Speaker	two 4-ohm speakers
Internal speaker amplifier	1.9 W per channel into 4 ohms
Volume controls	keyboard shortcuts, program menus

Display	
Type (active-matrix TFT)	SXGA+, UXGA, or Enhanced UXGA
Dimensions:	
Height	228.1 mm (9 inches)
Width	304.1 mm (12 inches)
Diagonal	380.1 mm (15 inches)
Maximum resolutions	1400 x 1050 at 16.8 million colors (SXGA+) 1600 x 1200 at 16.8 million colors (UXGA and Enhanced UXGA)
Response time (typical)	20-ms rise (maximum) (SXGA+ and UXGA) 30-ms fall (maximum) (SXGA+ and UXGA) 9-ms rise (maximum) (Enhanced UXGA) 16-ms fall (maximum) (Enhanced UXGA)
Refresh rate	60 Hz
Operating angle	0° (closed) to 180°
Pixel pitch	0.20 x 0.20 mm (SXGA+) 0.19 x 0.19 mm (UXGA and Enhanced UXGA)
Controls	brightness can be controlled through keyboard shortcuts

Keyboard	
Number of keys	87 (U.S. and Canada); 88 (Europe); 90 (Japan)

Key travel	2.7 mm \pm 0.3 (0.11 inch \pm 0.016 inch)
Key spacing	19.05 mm \pm 0.3 mm (0.75 inch \pm 0.012 inch)
Layout	QWERTY/AZERTY/Kanji

Touch Pad	
X/Y position resolution (graphics table mode)	240 cpi
Size:	
Width	64.88-mm (2.55-inch) sensor-active area
Height	48.88-mm (1.92-inch) rectangle

Track Stick	
X/Y position resolution (graphics table mode)	250 count/sec @ 100 gf
Size	protrudes 0.5 mm higher than surrounding keycaps

Battery	
Type	66-WHr "smart" lithium ion (4460 mAh)
Dimensions:	
Depth	88.5 mm (3.48 inches)
Height	21.5 mm (0.83 inch)
Width	139.0 mm (5.47 inches)
Weight	0.40 kg (0.88 lb)

Voltage	14.8 VDC
Charge time (approximate):	
Computer on	2.5 hours
Computer off	1.5 hours
Operating life	approximately 2 to 4 hours, depending on usage and configuration
Life span (approximate)	400 discharge/charge cycles
Temperature range:	
Operating	0° to 35°C (32° to 95°F)
Storage	-40° to 65°C (-40° to 149°F)

AC Adapter	
Input voltage	90–135 VAC and 164–264 VAC
Input current (maximum)	1.5 A
Input frequency	47–63 Hz
Output current	5.5 A (maximum at 4-second pulse); 4.5 A (continuous)
Output power	90 W
Rated output voltage	20 VDC
Dimensions:	
Height	27.94 mm (1.1 inches)
Width	58.42 mm (2.3 inches)
Depth	133.85 mm (5.25 inches)
Weight (with cables)	0.4 kg (0.9 lb)
Temperature range:	

Operating	0° to 40°C (32° to 95°F)
Storage	-40° to 65°C (-40° to 149°F)

Physical	
Height	44.5 mm (1.75 inches)
Width	331.0 mm (13.03 inches)
Depth	276.0 mm (10.87 inches)
Weight (average, depending on configuration)	3.46 kg (7.64 lb)

Environmental	
Temperature range:	
Operating	0° to 35°C (32° to 95°F)
Storage	-40° to 65°C (-40° to 149°F)
Relative humidity (maximum):	
Operating	10% to 90% (noncondensing)
Storage	5% to 95% (noncondensing)
Maximum vibration (using a random-vibration spectrum that simulates a user environment):	
Operating	0.9 GRMS
Storage	1.3 GRMS
Maximum shock (measured with the hard drive in head-parked position and with a 2-ms half-sine pulse):	
Operating	122 G

Storage	163 G
Altitude (maximum):	
Operating	-15.2 to 3048 m (-50 to 10,000 ft)
Storage	-15.2 to 10,668 m (-50 to 35,000 ft)

[Back to Contents Page](#)

[Back to Contents Page](#)

Power Management

Dell™ Inspiron™ 8200

- [Management Tips](#)
 - [Power Management Modes](#)
 - [Power Options Properties](#)
-

Management Tips

- Connect the Dell™ computer to an electrical outlet when possible because the battery life expectancy is largely determined by the number of times the battery is charged.
 - Place the computer in [standby mode](#) or [hibernate mode](#) when you leave the computer unattended for long periods of time.
 - To exit a power management mode, press the power button.
-

Power Management Modes

Standby Mode

Standby mode conserves power by turning off the display and the hard drive after a predetermined period of inactivity (a time-out). When the computer exits standby mode, it returns to the same operating state it was in before entering standby mode.



- **NOTICE:** If your computer loses AC and battery power while in standby mode, it may lose data.

To enter standby mode:

- Click the **Start** button, click **Turn off computer**, and then click **Stand by**.

or

- Depending on how you set the power management options on the [Advanced tab](#), use one of the following methods:
 - Press the power button.
 - Close the display.

- Press   .

To exit standby mode, press the power button or open the display depending on how you set the options on the [Advanced tab](#). You cannot make the computer exit standby mode by pressing a key or touching the touch pad or track stick.

Hibernate Mode

Hibernate mode conserves power by copying system data to a reserved area on the hard drive and then completely turning off the computer. When the computer exits hibernate mode, it returns to the same operating state it was in before entering hibernate mode.

- ➔ **NOTICE:** You cannot remove devices or undock your computer while your computer is in hibernate mode.

Your computer enters hibernate mode if the battery charge level becomes critically low.

Depending on how you set the power management options on the [Advanced tab](#), use one of the following methods to enter hibernate mode:

- Press the power button.
- Close the display.

- Press   .

 **HINT:** Some PC Cards may not operate correctly after the computer exits hibernate mode. Remove and reinsert the card, or simply restart (reboot) your computer.

To exit hibernate mode, press the power button. The computer may take a short time to exit hibernate mode. You cannot make the computer exit hibernate mode by pressing a key or touching the touch pad or track stick. For more information on hibernate mode, see the documentation that came with your operating system.

Power Options Properties

To access the Microsoft® Windows® **Power Options Properties** window:

1. Click the **Start** button and click **Control Panel**.
2. Under **Pick a category**, click **Performance and Maintenance**.
3. Under **or pick a Control Panel icon**, click **Power Options**.

Power Schemes Tab

The **Power schemes** pull-down menu displays the selected preset power scheme. Depending on your operating system, typical power schemes are:

 **HINT:** Dell recommends that you use the **Portable/Laptop** power scheme to maximize battery power.

- **Portable/Laptop**
- **Home/Office**
- **Always On**

- **Presentation**
- **Minimal Power Management**
- **Max Battery**

Windows XP controls the performance level of the processor depending on the power scheme you select. You do not need to make any further adjustments to set the performance level.

Each preset power scheme has different time-out settings for entering standby mode, turning off the display, and turning off the hard drive. For more information on power management options, see the Help and Support Center.

Alarms Tab



HINT: To enable audible alarms, click each **Alarm Action** button and select **Sound alarm**.

The **Low battery alarm** and **Critical battery alarm** settings alert you with a message when the battery charge falls below a certain percentage. When you receive your computer, the **Low battery alarm** and **Critical battery alarm** check boxes are selected. Dell recommends that you continue to use these settings.

Power Meter Tab

The **Power Meter** tab displays the current power source and amount of battery charge remaining.

Advanced Tab

The **Advanced** tab allows you to:

- Set power icon and standby mode password options.
- Depending on your operating system, program the following functions:
 - Prompt user for an action (**Ask me what to do**).
 - Activate standby mode.

- Activate hibernate mode.
- Shut down Windows and turn off the computer.
- Choose no action (**None** or **Do nothing**).

To program these functions, click an option from the corresponding pull-down menu, and then click **OK**.

Hibernate Tab

The **Hibernate** tab lets you enable hibernate mode by clicking the **Enable hibernate support** check box.

[Back to Contents Page](#)

[Back to Contents Page](#)

Pin Assignments for I/O Connectors

Dell™ Inspiron™ 8200

USB Connector

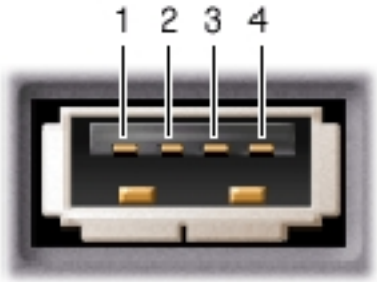

Pin	Signal
1	VCC
2	-Data
3	+ Data
4	Ground

Serial Connector



1 2 3 4 5
6 7 8 9

Pin	Signal	Pin	Signal
1	DCD	6	DSR
2	RXDA	7	RTS
3	TXDA	8	CTS
4	DTR	9	RI
5	GND		

Parallel Connector



13 12 11 10 9 8 7 6 5 4 3 2 1
25 24 23 22 21 20 19 18 17 16 15 14

Pin	Signal	Pin	Signal

1	STRB#	11	BUSY
2	PDO	12	PE
3	PD1	13	SLCT
4	PD2	14	AFDF#
5	PD3	15	ERROR#
6	PD4	16	INIT#
7	PD5F	17	SLCT_IN
8	PD6F	18-23	GND
9	PD7F	24	DFDD/LPT#
10	ACK#	25	GND

Video Connector



Pin	Signal	Pin	Signal
1	RED	9	CRT_VCC
2	GREEN	10	GND
3	BLUE	11	MSEN#
4	NC	12	DAT_DDC2
5	GND	13	HSYNC

6	GND	14	VSYNC
7	GND	15	CLK_DDC2
8	GND		

PS/2 Connector

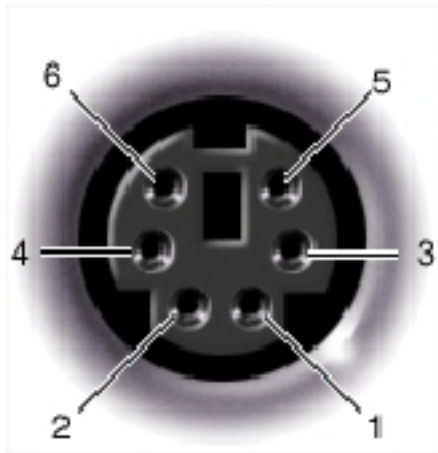

Pin	Signal
1	DAT_KBD
2	DAT_SM1
3	GND
4	PS2VCC
5	CLK_KBD
6	CLK_SM1

S-Video TV-Out Connector

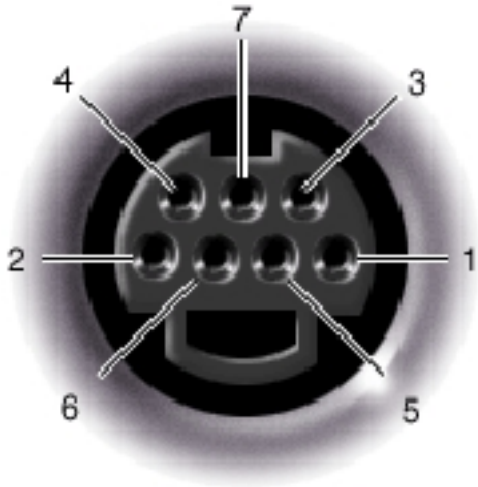

S-Video

Pin	Signal
1	GND
2	GND
3	DLUMA-L
4	DCRMA-L

Composite Video

Pin	Signal
5	SPDIF
6	DCMPS-L
7	SPGND

Docking Connector

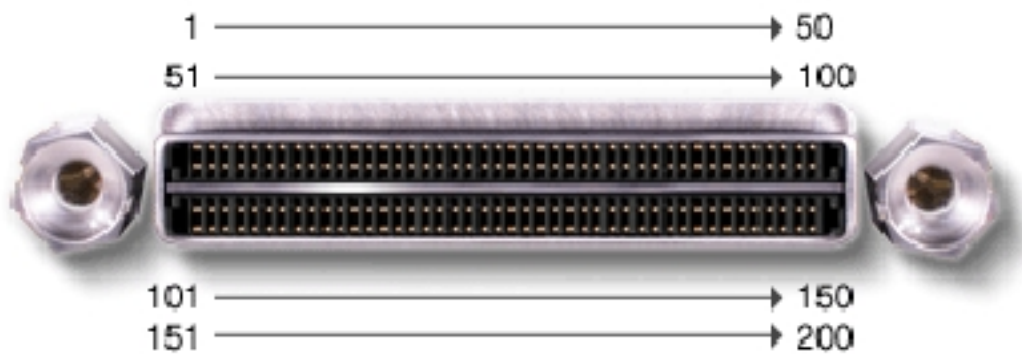

Pin	Signal	Pin	Signal
1	STRB#/5V	101	VGA_GRN
2	PD0	102	GND
3	PD1	103	VGA_RED
4	PD2	104	GND
5	PD3	105	VGA_BLU
6	PD4	106	DOCK_SD/MODE
7	PD5	107	D_IRTX
8	PD6	108	D_IRRX
9	PD7	109	GND
10	GND	110	SPIRQB#
11	DOCK_SPKR	111	SPIRQC#
12	DOCK_MIC	112	DAT_DDC2
13	DOCK_LINE	113	CLK_DDC2
14	DOCK_CDROM	114	SPAR
15	GND	115	SPME#
16	M_SEN#	116	GND
17	POWER_SW#	117	SSERR#

18	QPCIEN#	118	SPERR#
19	S1.6M_EN#	119	SLOCK#
20	DFDD/LPT#	120	SSTOP#
21	GND	121	GND
22	NC	122	SDEVSEL#
23	NC	123	STRDY#
24	D_ATCTLED	124	SIRDY#
25	D_PWRLED	125	SFRAME#
26	DOCK_PWR_SRC	126	SCLKRUN#
27	DOCK_PWR_SRC	127	GND
28	DOCK_PWR_SRC	128	SGNTA#
29	GND	129	SREQA#
30	+5VDOCK	130	SGNT0#
31	+5VDOCK	131	SREQ0#
32	+5VDOCK	132	SPCIRST#
33	+5VDOCK	133	SH1SEL#
34	+5VDOCK	134	GND
35	GND	135	SWRPRT#
36	DOCK_PWR_SRC	136	SDSKCHG#/DRQ
37	DOCK_PWR_SRC	137	SDIR#
38	DOCK_PWR_SRC	138	STRK0#
39	DOCK_PWR_SRC	139	SSTEP#
40	GND	140	SDRV1#
41	DOCK_+DC_IN	141	GND
42	DOCK_+DC_IN	142	SMRT1#
43	DOCK_+DC_IN	143	SWRDATA#
44	DOCK_+DC_IN	144	SWGATE#

45	DOCK_+DC_IN	145	SRDATA#
46	DOCK_+DC_IN	146	SINDEX#
47	DOCK_+DC_IN	147	GND
48	DOCK_+DC_IN	148	NC
49	GND	149	+5VALW
50	LOW_PWR	150	NC
51	HSYNC	151	GND
52	VSYNC	152	CLK_SPCI
53	GND	153	GND
54	DOCKED	154	SAD0
55	USB_VD1+	155	SAD1
56	USB_VD1-	156	SAD2
57	GND	157	SAD3
58	USB_VD2+	158	SAD4
59	USB_VD2-	159	SAD5
60	DOCKOCI#	160	SAD6
61	RUN_ON#	161	GND
62	GND	162	SAD7
63	NC	163	SAD8
64	DOCK_SCLK	164	SC/BE0#
65	DOCK_LRCK	165	SAD9
66	DOCK_MCLK	166	SAD10
67	GND	167	SAD11
68	+12V	168	SAD12
69	AFD#	169	GND
70	ERROR#	170	SAD13
71	ACK#	171	SAD14

72	GND	172	SAD15
73	INIT#	173	SAD16
74	SLCT_IN#	174	SC/BE1#
75	BUSY	175	CD/BE2#
76	PE	176	GND
77	SLCT	177	SAD17
78	GND	178	SAD18
79	DAT_SMB	179	SAD19
80	DCLK_SMB	180	SAD20
81	SMB_INIT#	181	SAD21
82	GND	182	GND
83	DAT_DOCKSM1	183	SAD22
84	CLK_DOCKSM1	184	SAD23
85	DAT_DOCKKBD	185	SAD24
86	CLK_DOCKKBD	186	SC/BE3#
87	GND	187	SAD25
88	RIO	188	GND
89	CTS0	189	SAD26
90	RTS0	190	SAD27
91	DSR0	191	SAD28
92	GND	192	SAD29
93	DTR0	193	SAD30
94	TXD0#	194	SAD31
95	RXD0#	195	GND
96	DCD0	196	NC
97	NC	197	NC
98	+5VSUS	198	NC

99	NC	199	NC
100	NC	200	GND

IEEE 1394 Connector



Pin	Signal
1	TPB-
2	TPB+
3	TPA-
4	TPA+

[Back to Contents Page](#)

[Back to Contents Page](#)

Removing and Replacing Parts

Dell™ Inspiron™ 8200

- [Before You Begin](#)
- [System Components](#)
- [Hard Drive and Fixed Optical Drive](#)
- [System Upgrades](#)
- [Keyboard](#)
- [Display](#)
- [Microprocessor Thermal-Cooling Assembly](#)
- [Microprocessor Module](#)
- [Video Graphics Board](#)
- [Palm Rest](#)
- [Reserve Battery](#)
- [System Board](#)
- [Battery and Module Bay Latches](#)
- [Battery Charger Board](#)
- [LED Board](#)
- [Fan](#)
- [RJ-11/RJ-45 Module](#)

[Back to Contents Page](#)

[Back to Contents Page](#)

Microprocessor Thermal-Cooling Assembly

Dell™ Inspiron™ 8200

- ➔ **NOTICE:** Disconnect the computer and attached devices from electrical outlets and remove any installed batteries.
- ➔ **NOTICE:** To avoid ESD, ground yourself by using a wrist grounding strap or by periodically touching unpainted metal on the computer.

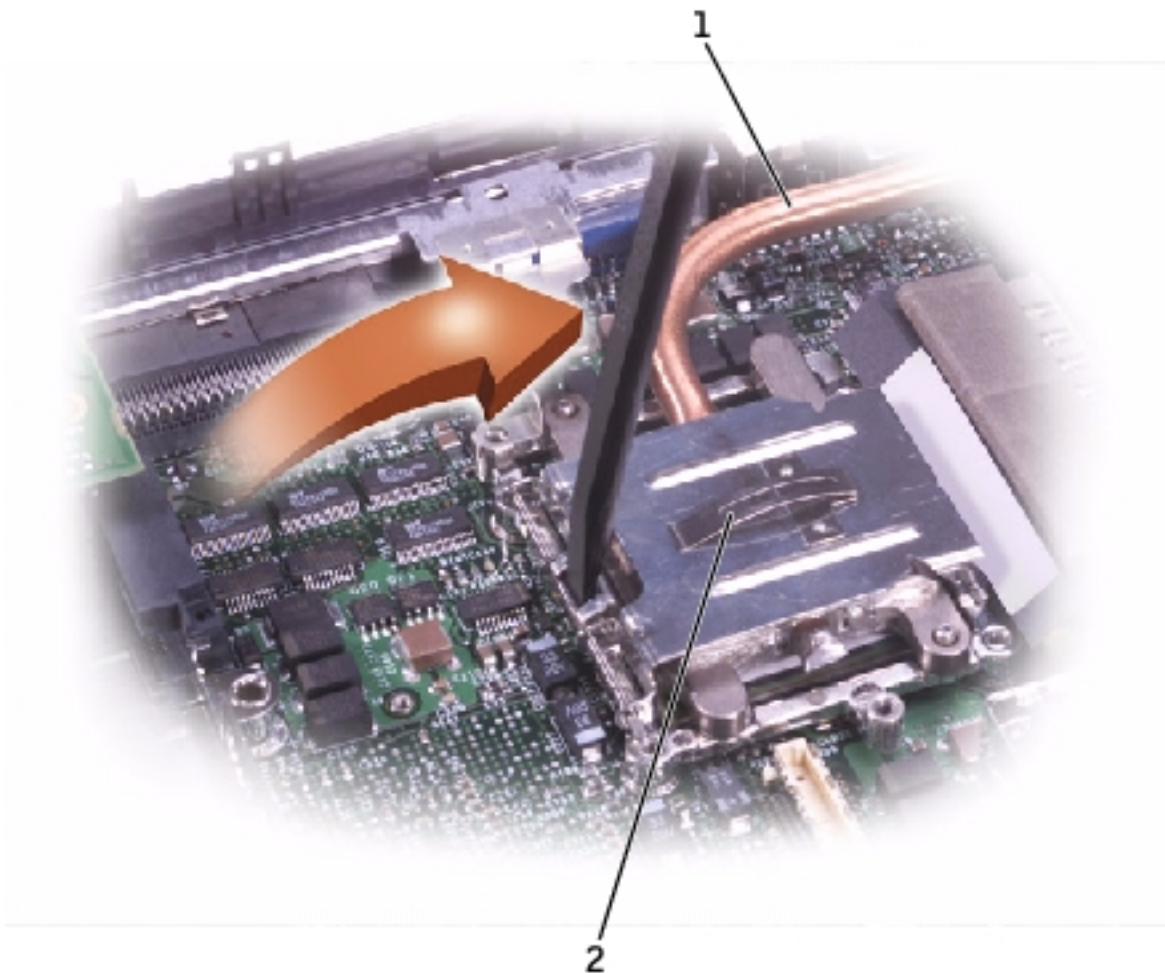

1	microprocessor thermal-cooling assembly
---	---

2	microprocessor retaining clip
---	-------------------------------

Removing the Microprocessor Thermal-Cooling Assembly

1. Follow the instructions in "[Preparing to Work Inside the Computer.](#)"
2. Remove the [keyboard.](#)
3. Remove the [hinge cover.](#)
4. Insert a non-marring plastic scribe into the latch mechanism at the left side of the microprocessor retaining clip. Pry open the clip by pivoting the top of the screwdriver toward the right side of the computer.

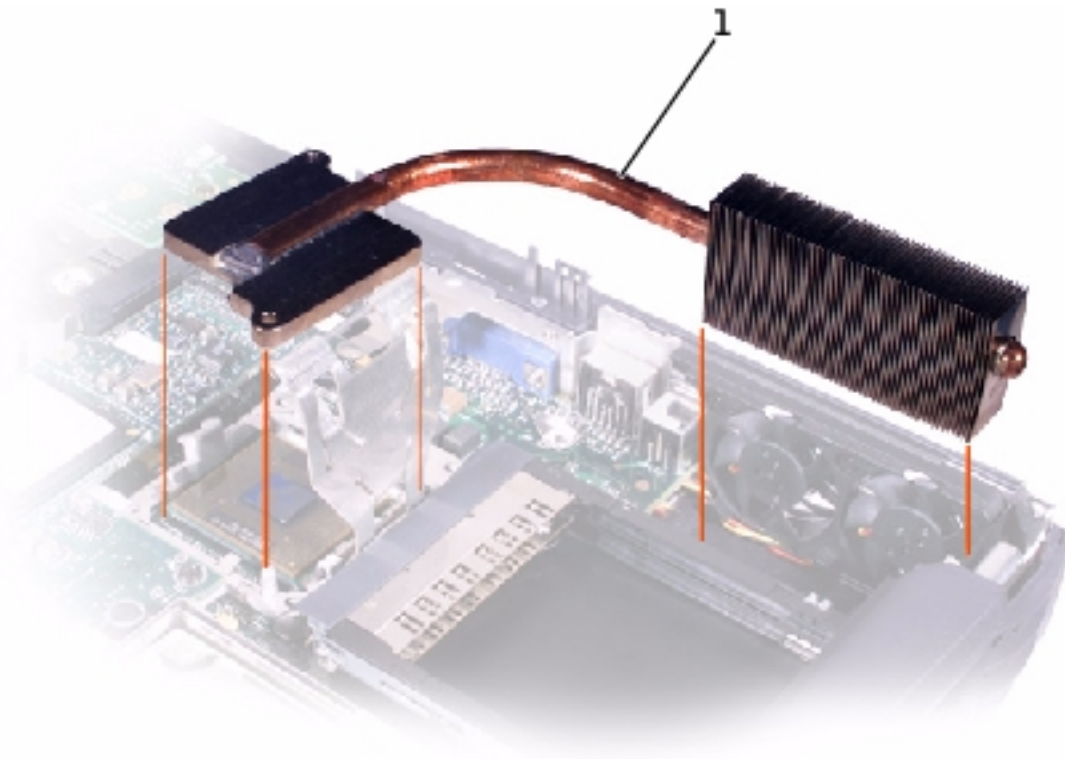

1	microprocessor thermal-cooling assembly
---	---

 **NOTICE:** To ensure maximum cooling for the microprocessor, do not touch the heat transfer areas on the microprocessor thermal-cooling assembly. The oils in your skin reduce the heat transfer capability of the thermal pads.

5. Lift out the thermal-cooling assembly.

[Back to Contents Page](#)

[Back to Contents Page](#)

Before You Begin

Dell™ Inspiron™ 8200

- [Preparing to Work Inside the Computer](#)
 - [Recommended Tools](#)
 - [Computer Orientation](#)
 - [Screw Identification](#)
-

Preparing to Work Inside the Computer

 **CAUTION:** Only a certified service technician should perform repairs on your computer. Damage due to servicing that is not authorized by Dell is not covered by your warranty. Read and follow applicable safety instructions in the *Owner's Manual* that came with the computer.

 **CAUTION:** Allow the computer to cool to room temperature before working inside the computer.

 **NOTICE:** To avoid damaging the computer, perform the following steps before you begin working inside the computer.

1. Ensure that the work surface is flat and clean to prevent scratching the computer cover.
2. Save any work in progress and exit all open programs.
3. Turn off the computer and all attached devices.

 **HINT:** Before turning off the computer, ensure that the computer is not in a power-management mode.

4. Ensure that the computer is undocked.

5. Disconnect the computer from the electrical outlet.
6. To avoid possible damage to the system board, wait 10 to 20 seconds and then disconnect any attached devices.
7. Disconnect all other external cables from the computer.
8. Remove any installed PC Cards or plastic blanks from the PC Card slot.
9. Close the display and turn the computer upside down on a flat work surface.
10. Remove the battery from the battery bay.

 **NOTICE:** To avoid component damage, always remove any installed batteries before you service the computer.

11. Remove any device installed in the module bay.
12. To dissipate static electricity while you work, periodically touch an unpainted metal surface on the computer chassis.
13. Handle components and cards by their edges, and avoid touching pins and contacts.

Recommended Tools

The procedures in this document require the following tools:

- #1 magnetized Phillips screwdriver
- Small flat-blade screwdriver
- Microprocessor extractor
- Nonmarring plastic scribe
- Flash BIOS update program floppy disk or CD (provided when needed to upgrade the BIOS)

Computer Orientation

back of computer

left



right

front of computer

Screw Identification

When you are removing and replacing components, photocopy the placemat as a tool to lay out and keep track of the component screws. The placemat provides the number of screws and the sizes.



M3 x 5 mm



M2.5 x 20 mm



M2.5 x 8 mm



M2.5 x 6 mm



M2.5 x 4 mm
captive washer



M2.5 x 4 mm









M2 x 4 mm













M2 x 3 mm



NOTICE: When reinstalling a screw, you must use a screw of the correct diameter and length. Ensure that the screw is properly aligned with its corresponding hole, and avoid overtightening.

<p>Hard-Drive Door Security:</p> <p>M3 x 5 mm (1 each)</p> 	<p>Keyboard to Bottom Case:</p> <p>M2.5 x 20 mm (4 each; one in memory door and one in Mini PCI door)</p> 	<p>Display to Bottom Case:</p> <p>M2.5 x 6 mm (3 each; 2 at back of computer; 1 at display flex-cable strain relief)</p> 
<p>Display Bezel:</p> <p>Rubber screw covers (4 each)</p> <p>Plastic screw covers (2 each)</p> <p>M2.5 x 4 mm (6 each)</p> 	<p>Display Panel to Display Mounting Bracket:</p> <p>M2 x 3 mm (6 each)</p>  <p>Flex-Cable Mounting Bracket to Top Cover:</p>	<p>Video Graphics Board:</p> <p>M2.5 x 8 (3 each)</p> 

	<p>M2.5 x 4 mm (1 each)</p> 	
<p>Palm Rest to Bottom Case:</p> <p>M2.5 x 20 mm (9 each)</p>  <p>Palm Rest Bracket:</p> <p>M2.5 x 4 mm (4 each)</p> 	<p>System Board:</p> <p>M2.5 x 4 mm captive washer (3 each)</p>  <p>M2.5 x 20 mm (1 each)</p> 	<p>LED Board:</p> <p>M2 x 4 mm (2 each)</p> 
<p>Fan:</p> <p>M2 x 4 mm (3 each)</p> 	<p>Memory Module/Modem Cover:</p> <p>M2.5 x 20 mm (1 each)</p> 	<p>Modem Daughter Card:</p> <p>M2 x 3 mm (1 each)</p> 
<p>Mini PCI Card:</p> <p>M2.5 x 20 mm (1 each)</p> 		

[Back to Contents Page](#)

[Back to Contents Page](#)

System Components

Dell™ Inspiron™ 8200

➔ **NOTICE:** Unless otherwise noted, each procedure in this document assumes that a part can be replaced by performing the removal procedure in reverse order.

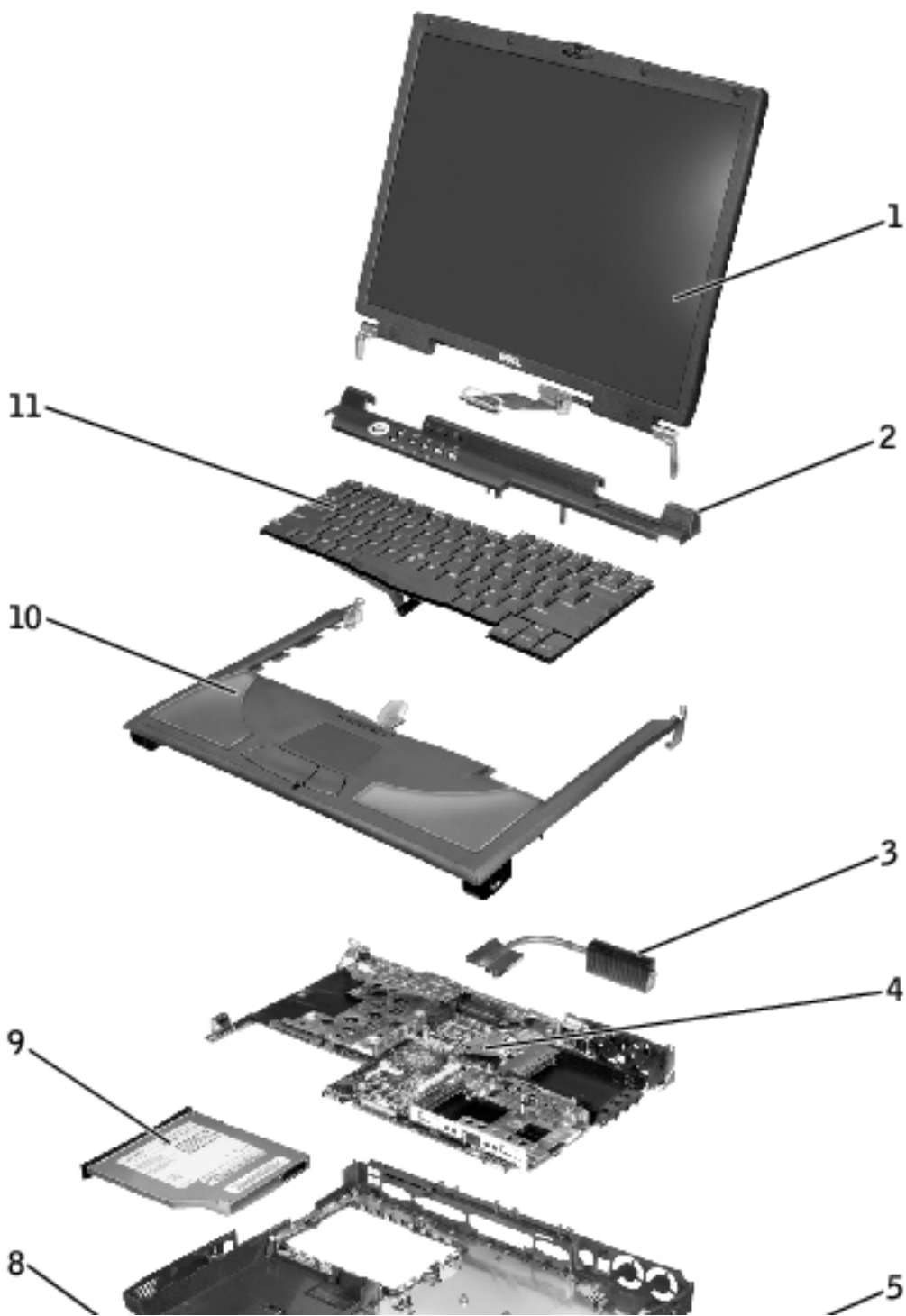

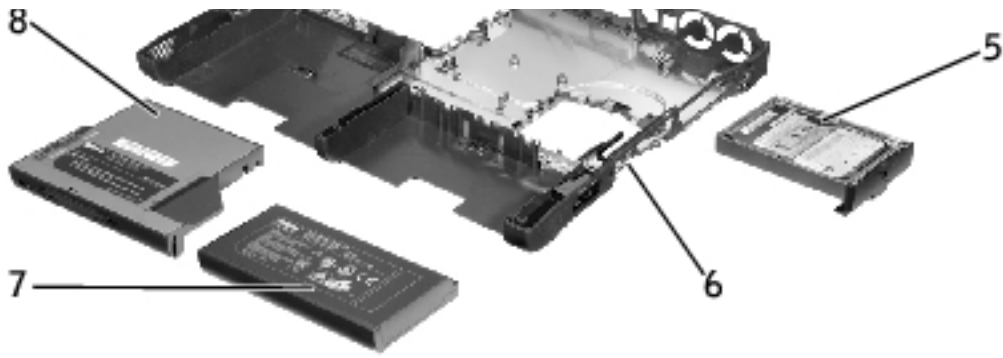

1	display assembly	7	main battery
2	hinge cover	8	device in module bay
3	microprocessor thermal-cooling assembly	9	fixed optical drive
4	system board	10	palm rest
5	hard drive	11	keyboard
6	bottom case		

[Back to Contents Page](#)

[Back to Contents Page](#)

Hard Drive and Fixed Optical Drive

Dell™ Inspiron™ 8200

• [Hard Drive](#)

• [Fixed Optical Drive](#)

- ➔ **NOTICE:** Only a certified service technician should perform repairs on your computer. Damage due to servicing that is not authorized by Dell is not covered by your warranty.
-

Hard Drive

- ➔ **NOTICE:** Disconnect the computer and attached devices from the electrical outlet and remove any installed batteries.
- ➔ **NOTICE:** To avoid ESD, ground yourself by using a wrist grounding strap or by periodically touching unpainted metal on the computer.
- ➔ **NOTICE:** The hard drive is very sensitive to shock. Handle the drive by its edges (do not squeeze the top of the case), and avoid dropping it.

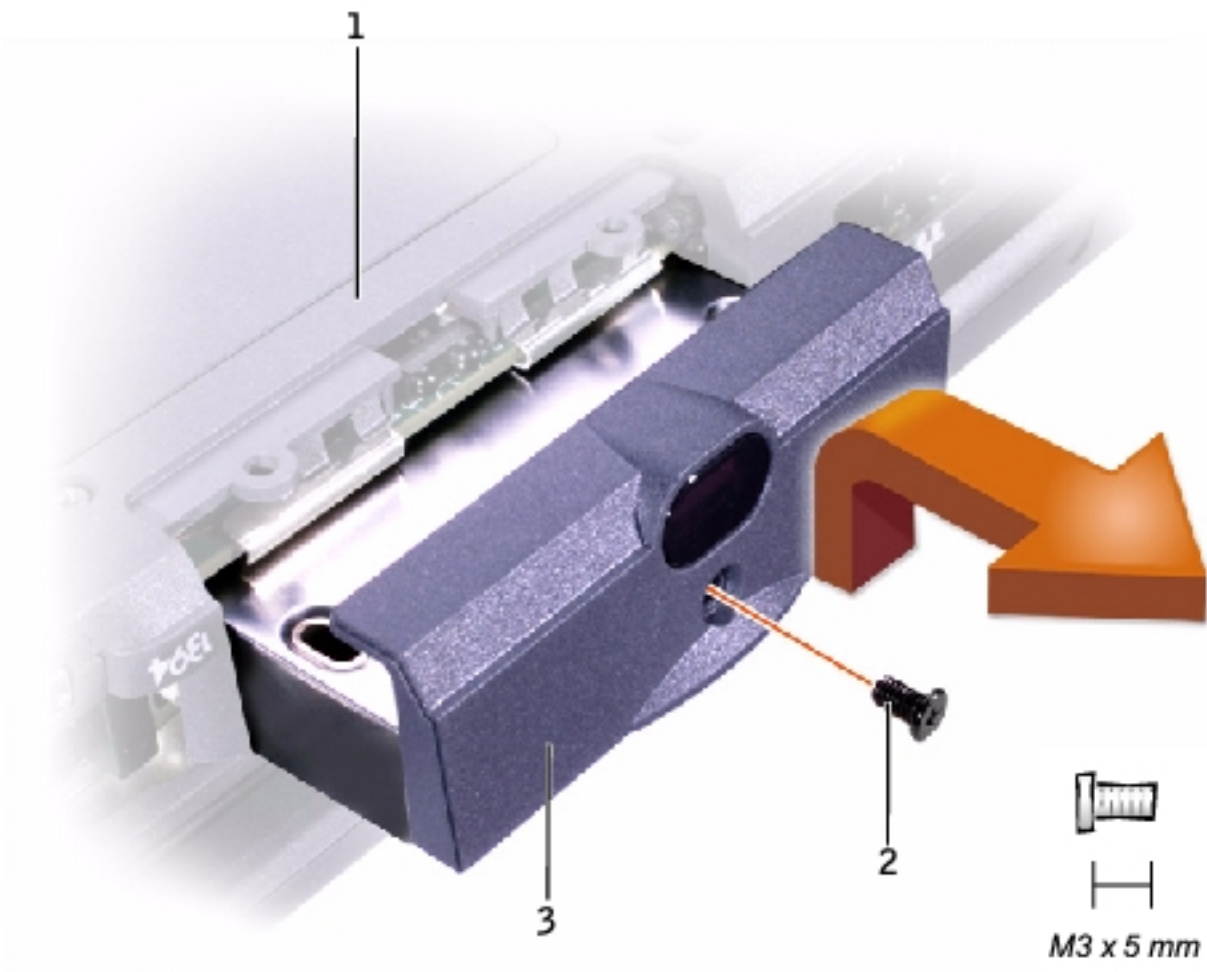

1	bottom of computer
2	M3 x 5-mm screw
3	hard drive door

Removing the Hard Drive

1. Follow the instructions in "[Preparing to Work Inside the Computer.](#)"
2. Remove the M3 x 5-mm screw.
3. Pull the hard drive out.

Replacing the Hard Drive

1. Push the hard drive into the drive bay until the drive door is flush with the computer case.

2. Push down on the drive until it snaps into place.
3. Replace the M3 x 5-mm screw in the hard drive door.

Fixed Optical Drive

- ➔ **NOTICE:** Disconnect the computer and attached devices from the electrical outlet and remove any installed batteries.
- ➔ **NOTICE:** To avoid ESD, ground yourself by using a wrist grounding strap or by periodically touching unpainted metal on the computer.

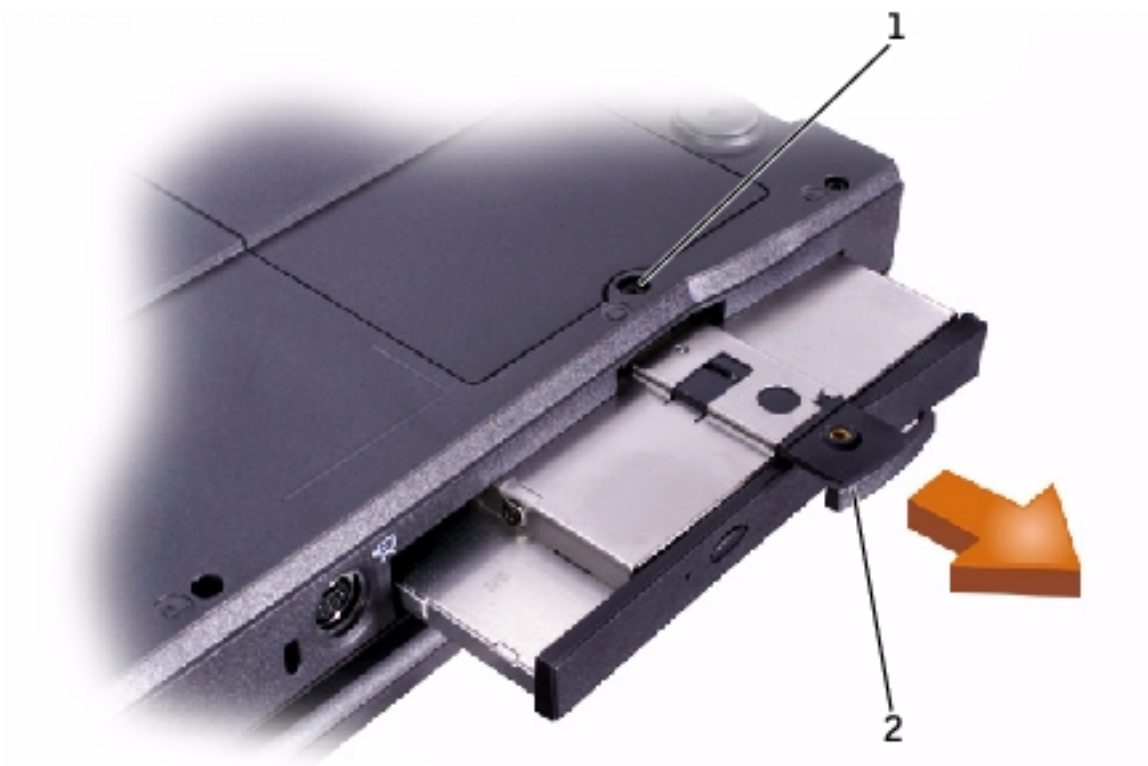

1	captive screw
2	pull tab

Removing the Fixed Optical Drive

1. Follow the instructions in "[Preparing to Work Inside the Computer.](#)"
 2. Loosen the captive screw on the bottom of the computer.
 3. Turn the computer over (to keep the captive screw from interfering with the pull tab) and pull out the pull tab.
 4. Use the pull tab to remove the fixed optical drive.
-

[Back to Contents Page](#)

[Back to Contents Page](#)

System Upgrades

Dell™ Inspiron™ 8200

- [Memory Modules](#)
 - [Modem Daughter Card](#)
 - [Mini PCI Card](#)
-

Memory Modules

- ➔ **NOTICE:** Disconnect the computer and any attached devices from electrical outlets and remove any installed batteries.
- ➔ **NOTICE:** To avoid ESD, ground yourself by using a wrist grounding strap or by periodically touching unpainted metal on the computer.

Removing the Memory Module/Modem Cover

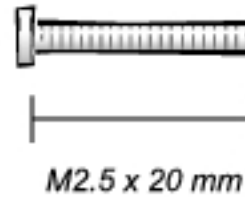
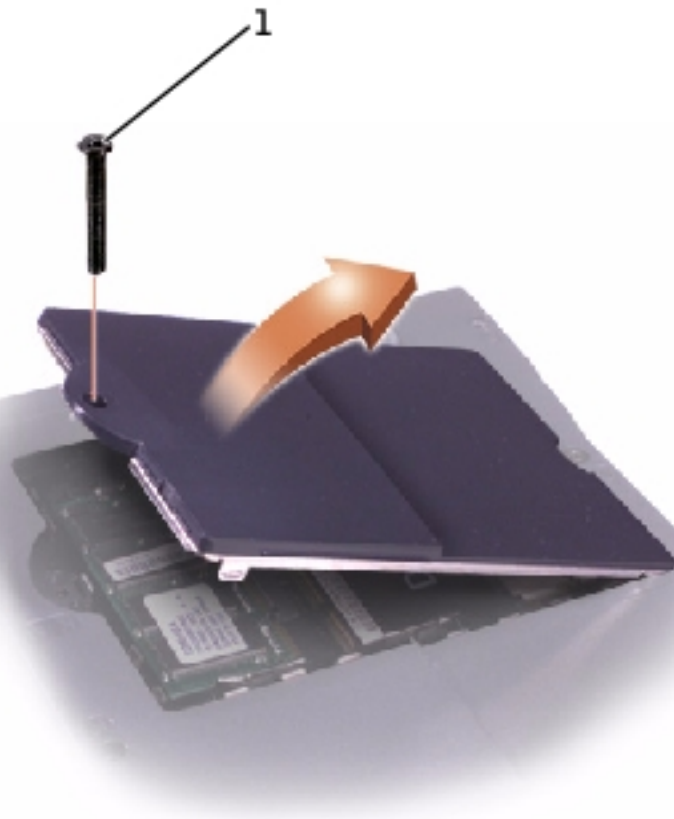

1	M2.5 x 20-mm screw
---	--------------------

1. Follow the instructions in "[Preparing to Work Inside the Computer.](#)"
2. Remove the M2.5 x 20-mm screw from the memory module/modem cover.
3. Disengage the metal tabs at the opposite end of the cover.

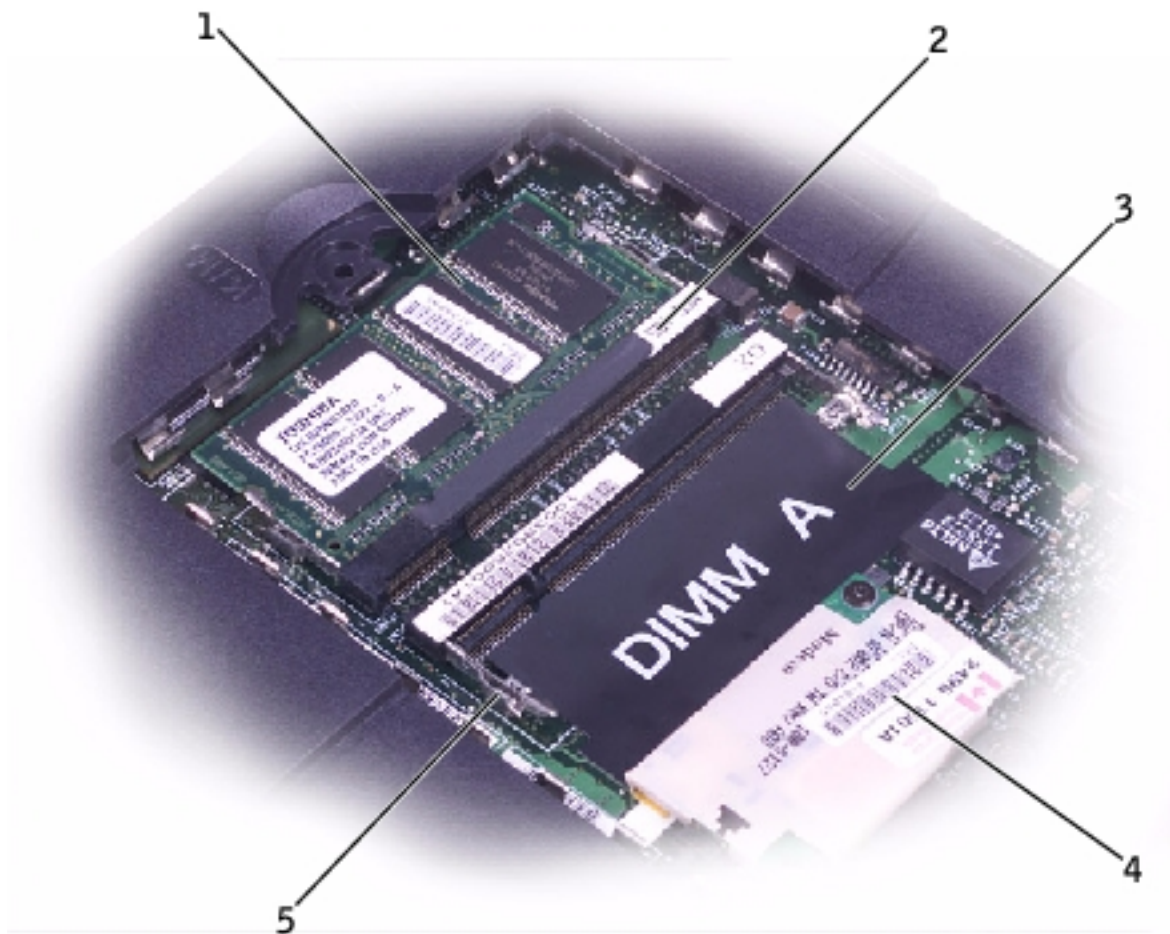

1	DIMM B
2	memory module sockets (2)
3	DIMM A socket
4	modem daughter card
5	metal tabs (2 per socket)

Removing the Memory Modules

1. Remove the [memory module/modem cover](#).
2. To release a memory module from its socket, spread apart the tabs at each side of the module until the module pops up slightly.
3. Lift the memory module out of its socket.

Replacing the Memory Modules

1. If you only have one memory module, install it in the socket labeled "DIMM A." Install a second memory module in the socket labeled "DIMM B."



HINT: Memory modules are keyed to fit into their sockets in only one direction.

2. Insert the memory-module edge connector into the socket slot at a 45-degree angle and press the module firmly into the slot.
 3. Pivot the module down until it clicks into place. If you do not hear a click, remove the module and reinstall it.
 4. Insert the metal tabs on the memory module/modem cover into the bottom case, rotate the cover down, and replace the M2.5 x 20-mm screw.
-

Modem Daughter Card

Removing the Modem Daughter Card



NOTICE: Disconnect the computer and any attached devices from electrical outlets and remove any installed batteries.



NOTICE: To avoid ESD, ground yourself by using a wrist grounding strap or by periodically touching unpainted metal on the computer.

1. Follow the instructions in "[Preparing to Work Inside the Computer](#)."
2. Turn the computer over and remove the [memory module/modem cover](#).

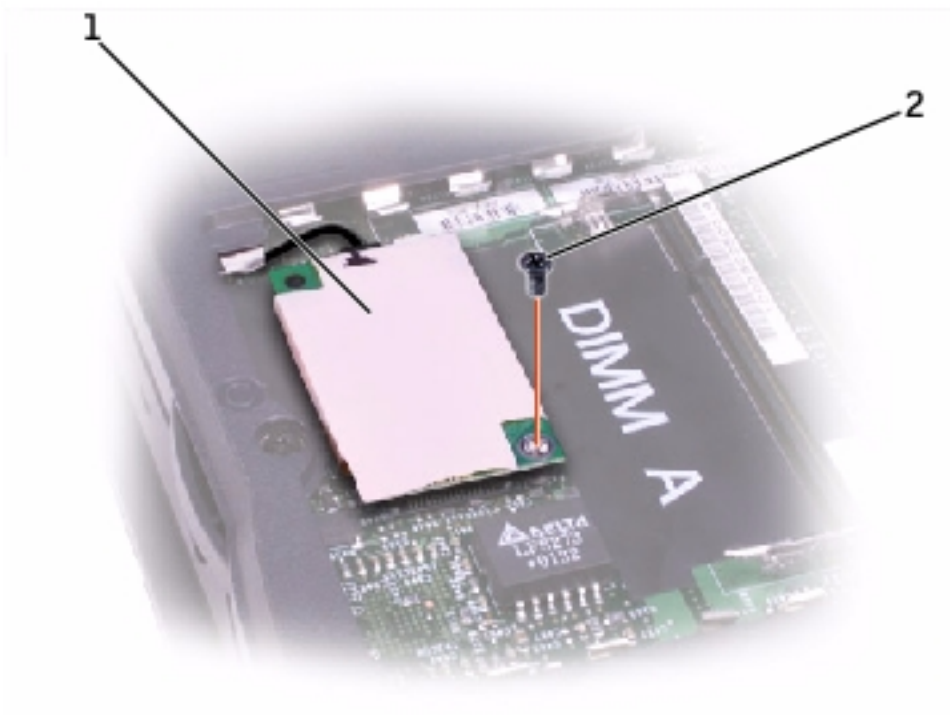

1	modem daughter card
2	M2 x 3-mm screw

- Remove the M2 x 3-mm screw that secures the modem daughter card to the system board.
- Use the pull tab to pull the modem daughter card straight up out of its connector.

➡ **NOTICE:** Do not pull on the modem cable. Pull the connector on the end of the cable to disconnect the cable.

- Disconnect the modem cable from the modem daughter card.

Replacing the Modem Daughter Card

➡ **NOTICE:** The cable connectors are keyed for correct insertion. Do not force the connections.

- Connect the modem cable to the modem daughter card.

2. Use the screw and boss holes at opposite corners of the modem daughter card to align the card, and press the card into its connector on the system board.
 3. Install the M2 x 3-mm screw that secures the card to the system board.
 4. Replace the memory module/modem cover.
-

Mini PCI Card

You must remove the optional Mini PCI wireless modem (if installed) before the system board can be removed. A wireless modem card must be connected to the internal antenna of the computer.

- ➔ **NOTICE:** Disconnect the computer and attached devices from electrical outlets and remove any installed batteries.
- ➔ **NOTICE:** To avoid ESD, ground yourself by using a wrist grounding strap or by periodically touching unpainted metal on the computer.

Mini PCI Card Cover

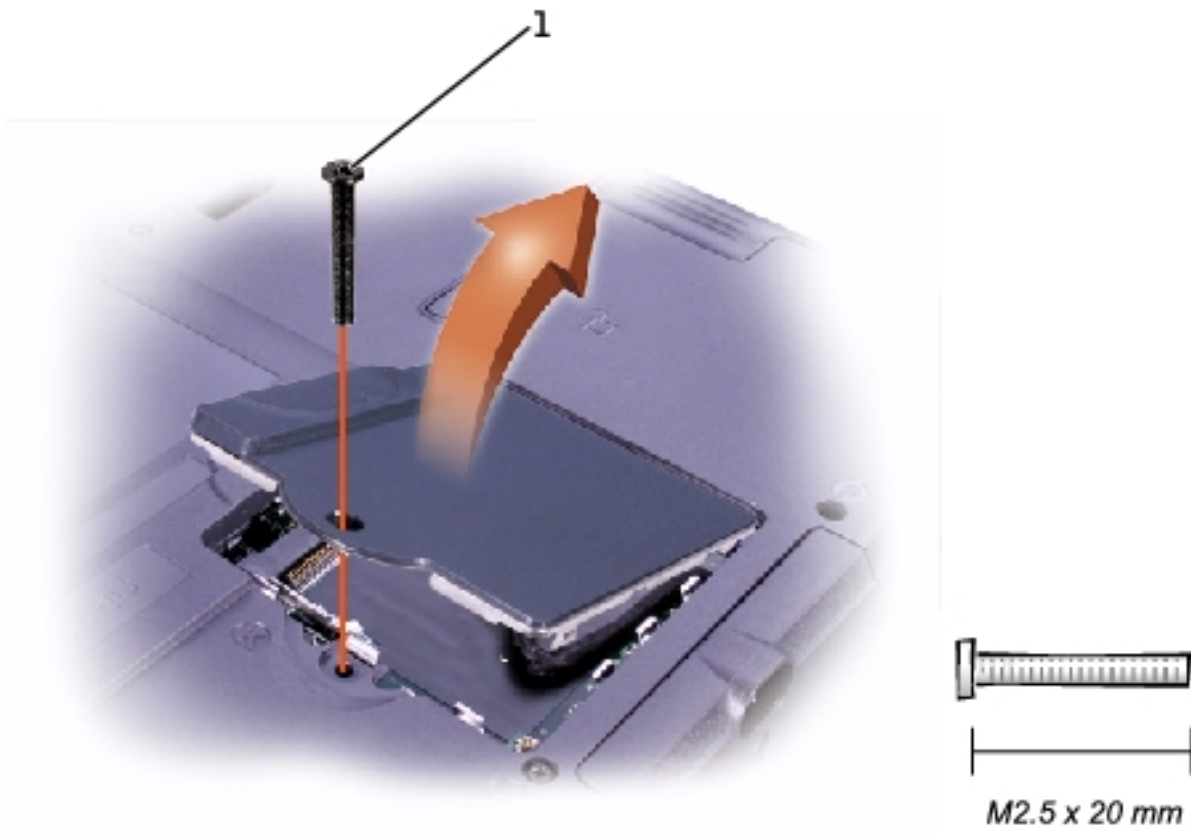

1	M2.5 x 20-mm screw
---	--------------------

Removing the Mini PCI Card

1. Follow the instructions in "[Preparing to Work Inside the Computer.](#)"
2. Remove the M2.5 x 20-mm screw and then remove the Mini PCI card cover.
3. To release the Mini PCI card, spread the metal securing tabs until the card pops up slightly.
4. Disconnect the card from the internal antenna.
5. Lift out the card and disconnect any attached cables.

Replacing the Mini PCI Card

1. Align the Mini PCI card with the socket at a 45-degree angle, and press the Mini PCI card into the socket.

2. Connect the internal-antenna cable to the primary-antenna connector on the card.

➔ NOTICE: The connectors are keyed for correct insertion; do not force the connections.

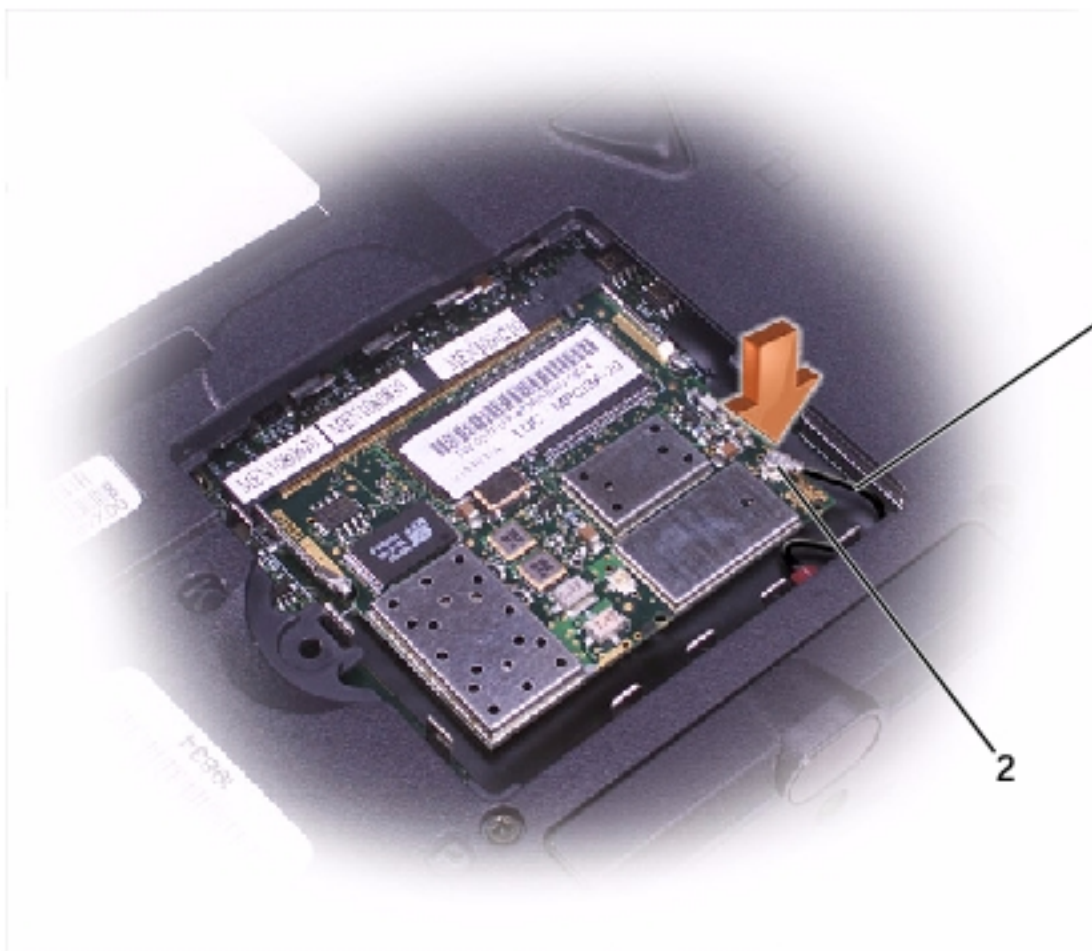

1	internal-antenna cable
2	primary-antenna connector on card

3. Pivot the Mini PCI card down until it clicks into place.
4. Replace the Mini PCI card cover and the M2.5 x 20-mm screw.

[Back to Contents Page](#)

[Back to Contents Page](#)

Keyboard

Dell™ Inspiron™ 8200

- ➔ **NOTICE:** Disconnect the computer and attached devices from electrical outlets and remove any installed batteries.
- ➔ **NOTICE:** To avoid ESD, ground yourself by using a wrist grounding strap or by periodically touching unpainted metal on the computer.

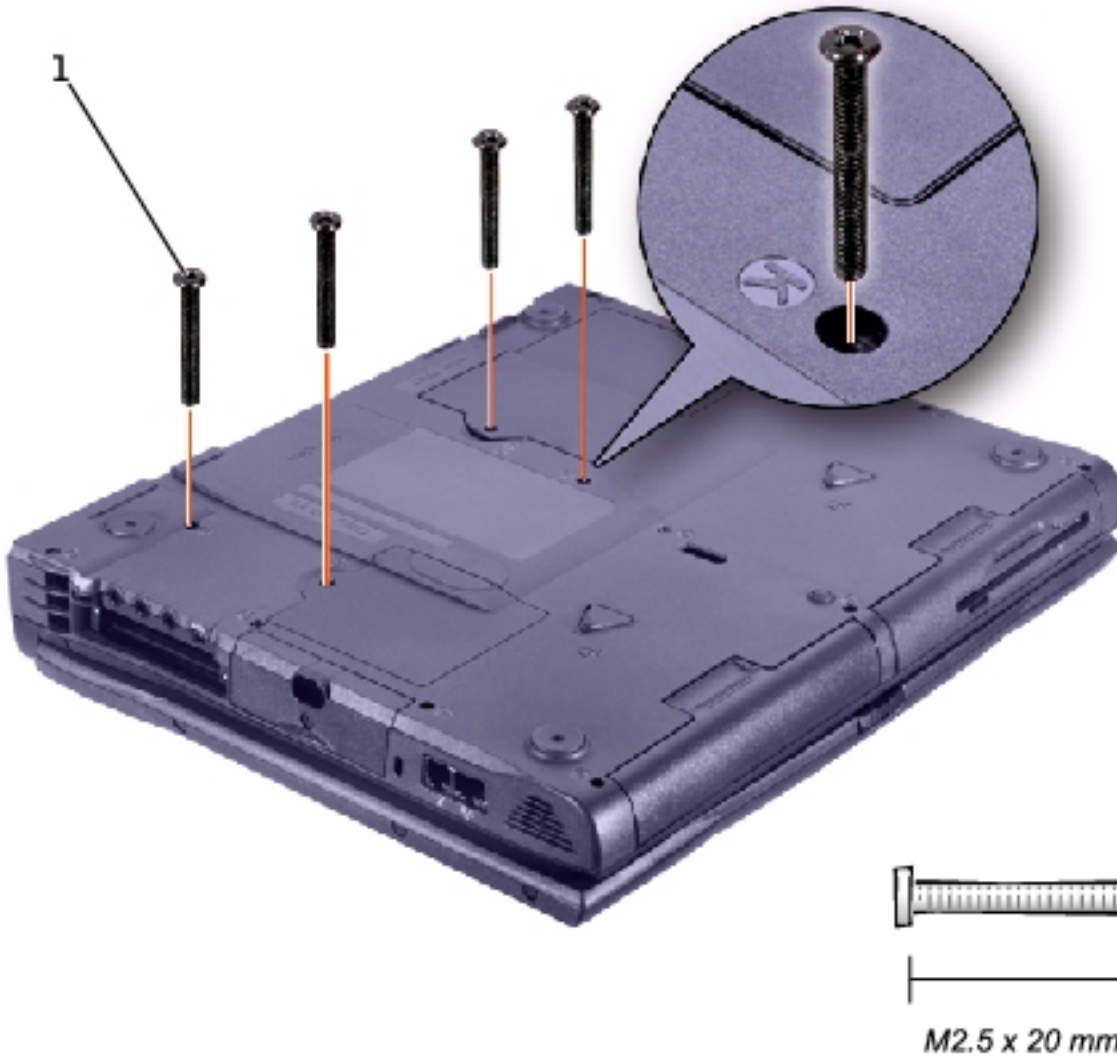

1	M2.5 x 20-mm screws (4)
---	----------------------------

Removing the Keyboard

1. Follow the instructions in "[Preparing to Work Inside the Computer.](#)"
2. Turn the computer over and remove the four M2.5 x 20-mm screws (three labeled "circle K" and one labeled "circle K/M").
3. Turn the computer over and open the display.

 **NOTICE:** Be careful when handling the keyboard. The keycaps are fragile, easily dislodged, and time-consuming to replace.

4. Use a nonmarring plastic scribe under the blank key to pry up the keyboard.

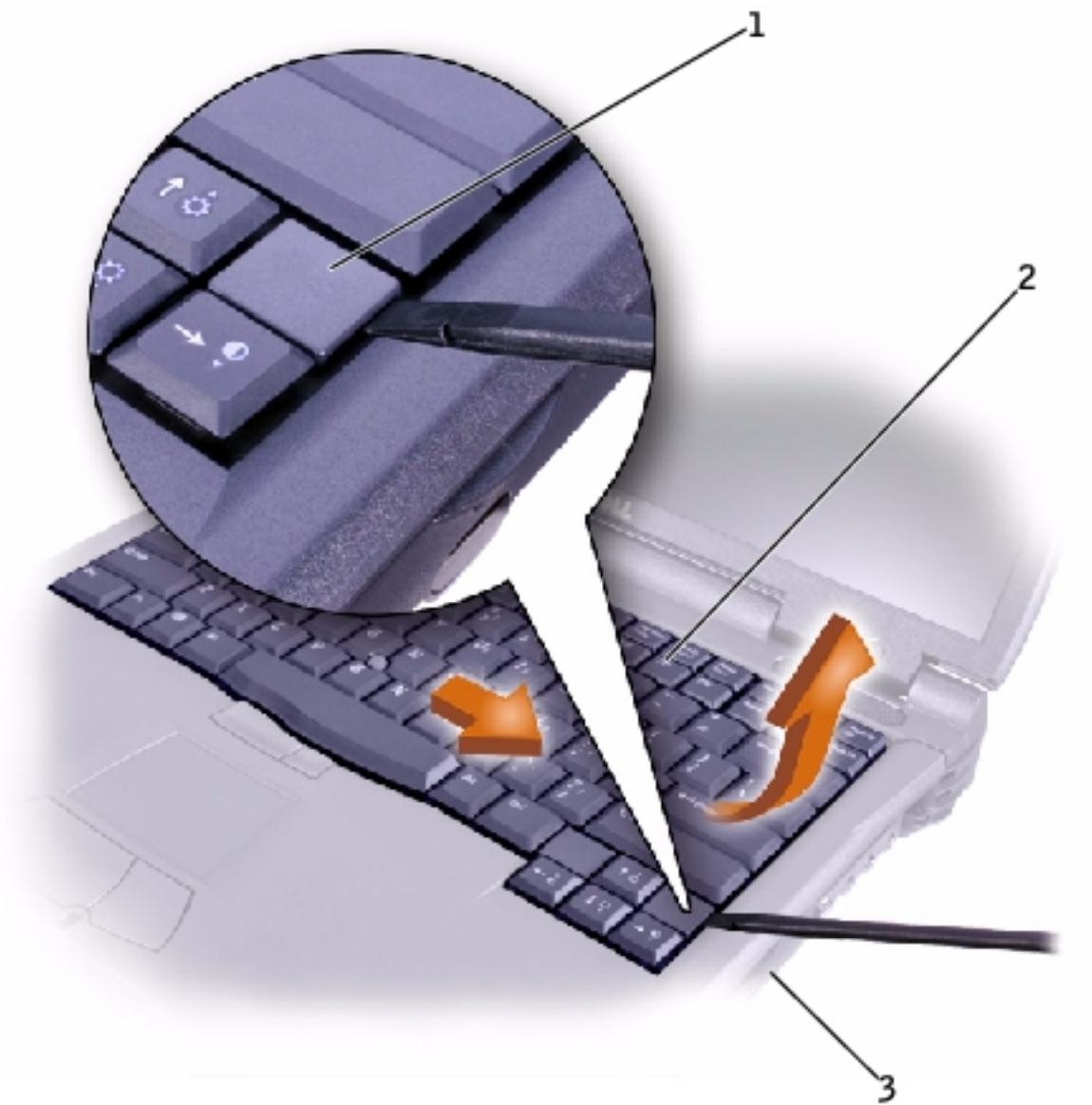

1	blank key
2	keyboard
3	right side of computer

5. Lift the right end of the keyboard and slide it slightly toward the right side of the computer to disengage the tabs at the left end.
6. Pivot the keyboard and balance it upright on the left side of the computer.

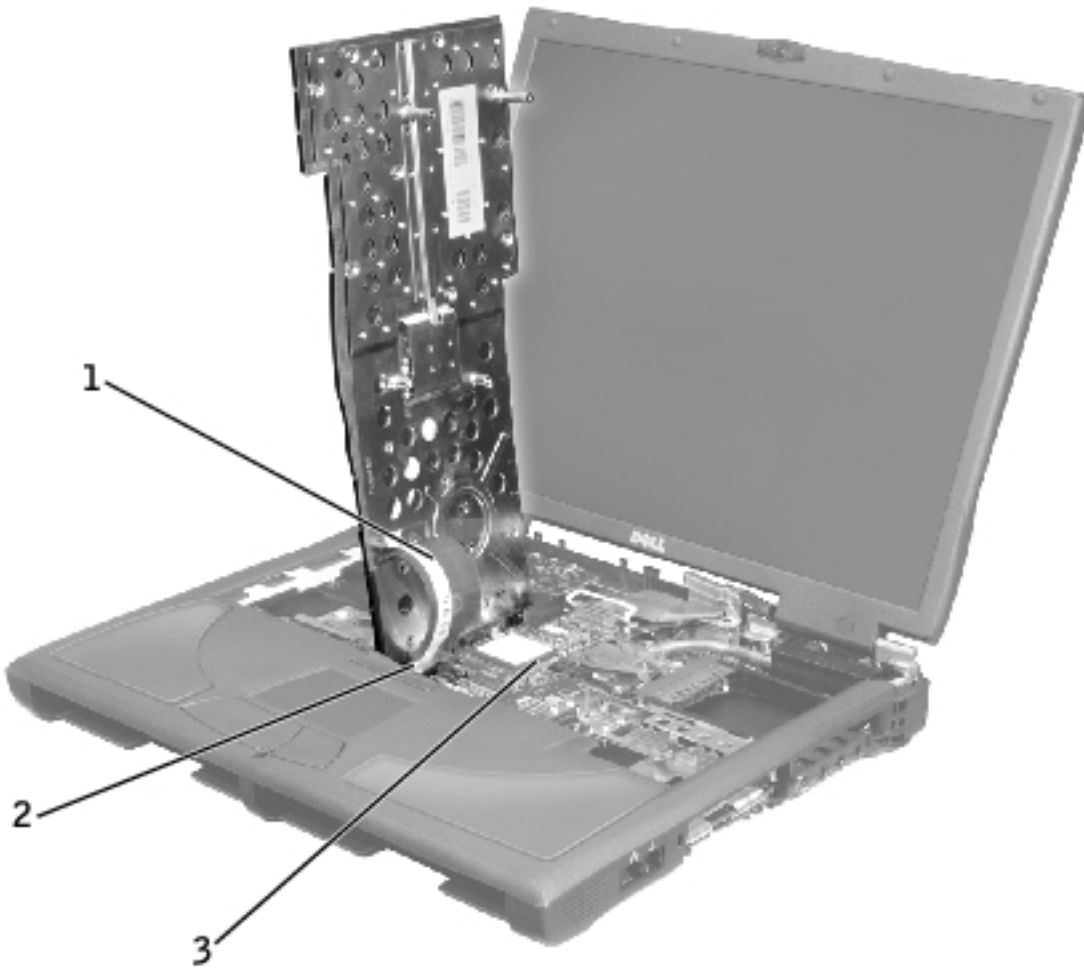

1	keyboard cable
2	keyboard interface connector
3	system board

7. Disconnect the keyboard cable and lay the keyboard aside.

Replacing the Keyboard

1. While bracing the keyboard upright on its left end, connect the keyboard cable to the keyboard interface connector on the system board.



NOTICE: Position the keyboard/track-stick flex cable so that it is not pinched when you replace the keyboard in the bottom case.

2. Insert the metal tabs at the left end of the keyboard under the edge of the bottom case, and fit the keyboard into place.
3. Check that the keyboard is correctly installed. The keys should be flush with the left and right surfaces of the palm rest.
4. Turn the computer over and reinstall the four M2.5 x 20-mm screws. For extra stability, you can open the computer slightly and brace the keyboard under each screw as you install the screw.

[Back to Contents Page](#)

[Back to Contents Page](#)

Display

Dell™ Inspiron™ 8200

- [Display Overview](#)
 - [Hinge Cover](#)
 - [Display Assembly](#)
 - [Display Bezel](#)
 - [Display Panel](#)
 - [Display Latch](#)
-

Display Overview

- ➔ **NOTICE:** Disconnect the computer and attached devices from electrical outlets and remove any installed batteries.
- ➔ **NOTICE:** To avoid ESD, ground yourself by using a wrist grounding strap or by periodically touching unpainted metal on the computer.

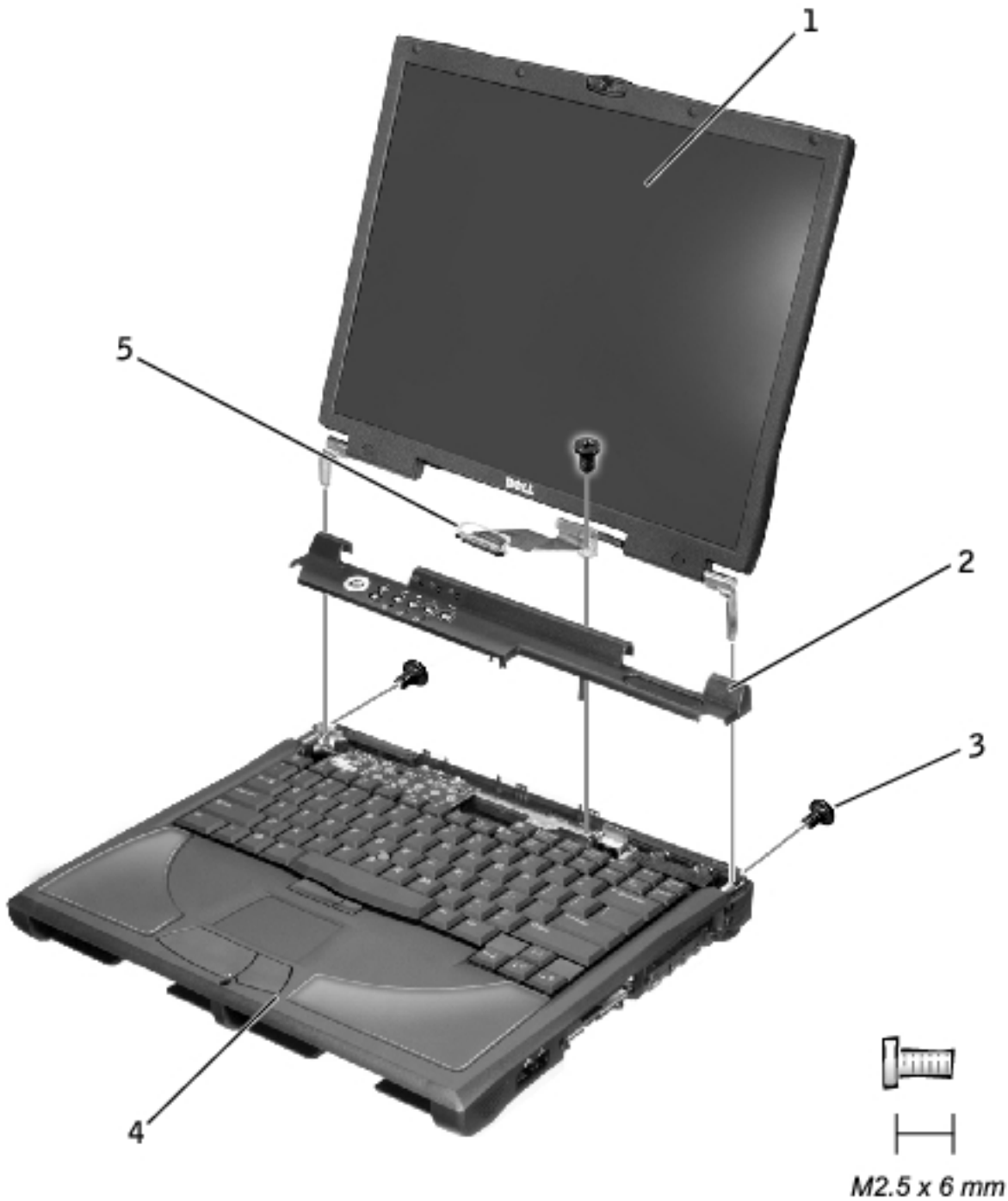

1	display
2	hinge cover
3	M2.5 x 6-mm screws (3)
4	bottom case
5	display flex cable

Hinge Cover



1	hinge cover
---	-------------

1. Follow the instructions in "[Preparing to Work Inside the Computer.](#)"
2. Use a nonmarring plastic scribe to loosen the hinge cover at the back and at each side of the computer.
3. Open the computer and use the scribe to pry between the  key and the hinge cover until the hinge cover pops off.
4. Open the display and lift off the hinge cover.

Display Assembly



1 M2.5 x 6-mm screws (2)

1. Remove the [hinge cover](#).

➔ **NOTICE:** Remove the display flex cable before you remove the display assembly.

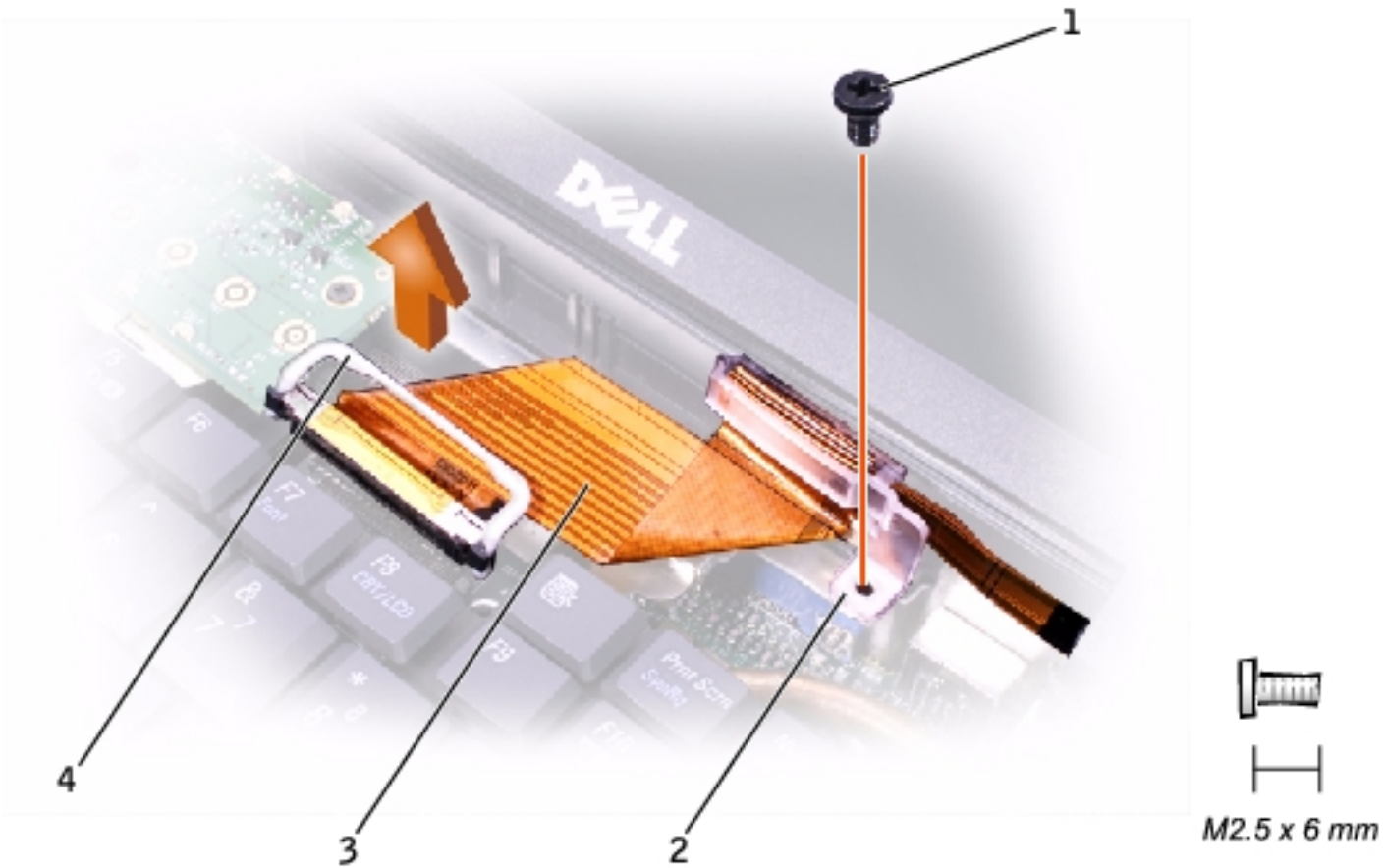

1	M2.5 x 6-mm screw
2	strain relief
3	display flex cable
4	pull loop

- Remove the M2.5 x 6-mm flex-cable strain relief screw, and then use the pull loop to remove the display flex cable from the graphics card.

NOTICE: When reconnecting the flex cable, press down on both ends of the connector, not in the middle. Pressing the middle of the connector can damage fragile components.

- Open the display and, from the back of the computer, remove the two M2.5 x 6-mm screws labeled "circle D" that secure the display assembly to the bottom case.
- With the display in an upright position, lift the display assembly from the bottom case.

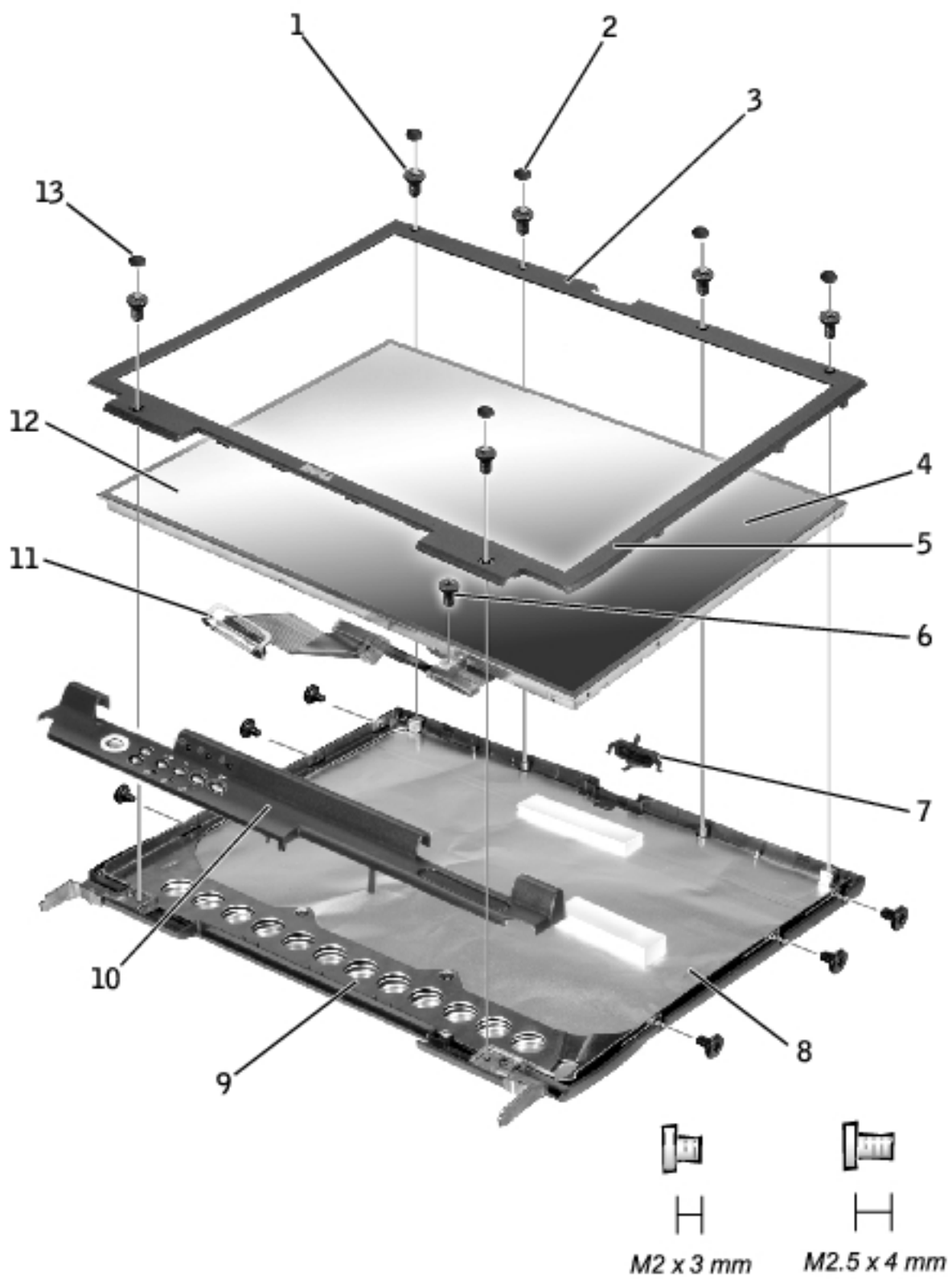

1	M2.5 x 4-mm screws (6)	8	M2 x 3-mm screws (6)
2	rubber screw covers (4)	9	top cover
3	display bezel	10	hinge cover
4	plastic tabs (6)	11	display flex cable
5	M2.5 x 4-mm screw	12	display panel
6	flex-cable mounting bracket	13	plastic screw covers (2)
7	display latch		

Display Bezel

1. Use a scribe to pry out the four rubber screw covers located across the top of the bezel.
2. Remove the four M2.5 x 4-mm screws located across the top of the bezel.
3. Use a scribe at the indentations to pry out the two plastic screw covers located at the bottom of the bezel.
4. Remove the two M2.5 x 4-mm screws located at the bottom of the bezel.
5. Separate the bezel from the top cover.

The bezel is secured to the top cover with plastic tabs around the sides. Use a plastic scribe to help separate the bezel from the top cover.

Display Panel

Removing the Display Panel

1. Remove the [hinge cover](#).

2. Detach the [display flex cable](#) from the strain relief and the graphics card.
3. Remove the [display bezel](#).
4. Remove the M2.5 x 4-mm screw that secures the plastic flex-cable mounting bracket to the top cover.
5. Remove the six M2 x 3-mm screws (three on each side) from the right and left sides of the panel.
6. Lift the display panel and flex cable out of the top cover.
7. Disconnect the flex cable from the two connectors (one ZIF and one standard connector) on the display panel.

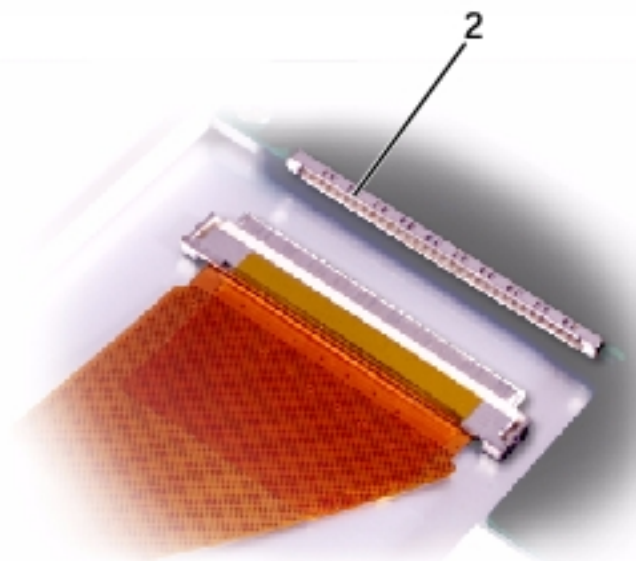
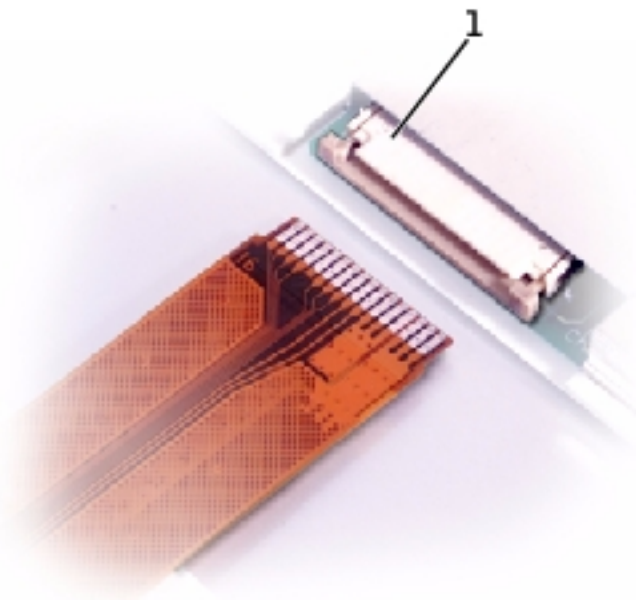

1	ZIF connector
2	standard connector

Replacing the Display Panel



HINT: Use a magnetic screwdriver to reassemble the display panel in the display.

1. Connect the flex cable to the two connectors on the back of the display panel.
2. Place the display panel in the top cover, taking care that the flex cable is in place and is not crushed or crimped.
3. Reinstall the M2.5 x 4-mm screw that secures the flex-cable mounting bracket to the top cover.
4. Starting on the left side, use a magnetic screwdriver to reinstall the six M2 x 3-mm screws that secure the display panel in the top cover.
5. Reinstall the M2.5 x 6-mm flex-cable strain relief screw that secures the display flex-cable strain relief, and reconnect the flex cable to the graphics card.
6. Reinstall the display bezel.

Display Latch



1. Remove the [hinge cover](#).
2. Detach the [display flex cable](#) from the strain relief and the graphics card.
3. Remove the [display bezel](#).
4. Remove the [display panel](#) from the top cover.
5. Remove the display latch by disengaging the latch and captive spring.

[Back to Contents Page](#)

[Back to Contents Page](#)

Microprocessor Module

Dell™ Inspiron™ 8200

- ➔ **NOTICE:** Disconnect the computer and attached devices from electrical outlets and remove any installed batteries.
- ➔ **NOTICE:** To avoid ESD, ground yourself by using a wrist grounding strap or by periodically touching unpainted metal on the computer.



Removing the Microprocessor Module

1. Follow the instructions in "[Preparing to Work Inside the Computer.](#)"
2. Remove the [keyboard](#).
3. Remove the [hinge cover](#).

➡ **NOTICE:** To ensure maximum cooling for the microprocessor, do not touch the heat transfer areas on the microprocessor thermal-cooling assembly. The oils in your skin reduce the heat transfer capability of the thermal pads.

4. Remove the [microprocessor thermal-cooling assembly](#).

➡ **NOTICE:** When removing the microprocessor module, pull the module straight up. Do not bend the pins.

5. Remove the microprocessor module.

➡ **NOTICE:** To avoid damage to the microprocessor, hold the screwdriver so that it is perpendicular to the microprocessor when loosening the cam screw (see "[Microprocessor Cam Screw](#)").

Microprocessor Cam Screw (Example)

➡ **NOTICE:** Hold the microprocessor down while turning the cam screw to prevent intermittent contact between the cam screw and microprocessor.

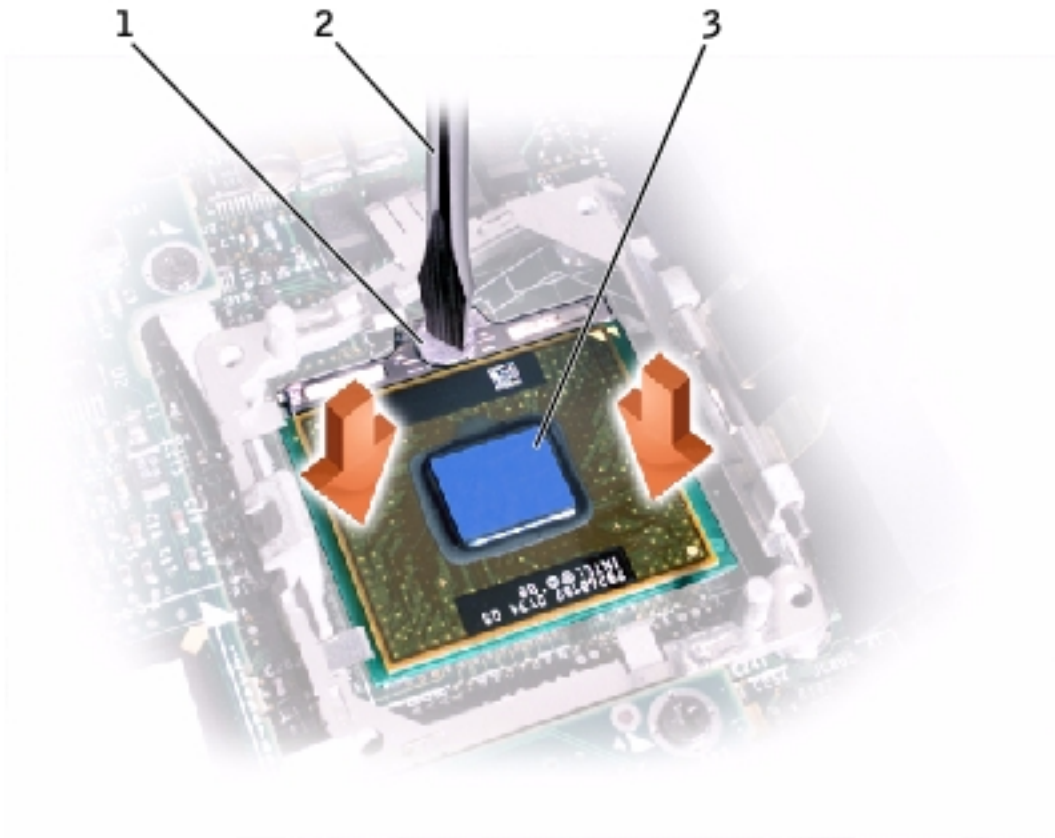

1	cam screw
2	perpendicular screwdriver
3	processor die (do not touch)

- a. Loosen the cam screw that secures the microprocessor module. The location of the screw and the rotation direction may vary with the socket manufacturer; look for small icons indicating open and locked positions.
- b. Use the microprocessor extraction tool to remove the microprocessor module.

Replacing the Microprocessor Module

- ➡ **NOTICE:** If you received a flash BIOS update program floppy disk or CD with the replacement microprocessor, you must update the BIOS after replacing the microprocessor module.

➡ **NOTICE:** Proper seating of the microprocessor module does not require force.

➡ **NOTICE:** A microprocessor module that is not properly seated can result in an intermittent connection and subsequent failures.

1. Align the pin-1 triangle on the microprocessor with the pin-1 triangle in the socket, insert the microprocessor into the socket, and move the microprocessor around slightly until you feel it settle into the socket.

When the microprocessor module is correctly seated, all four corners are aligned to the same height. If one or more corners of the module are higher than the others, the module is not seated correctly.

➡ **NOTICE:** Hold the microprocessor down while turning the cam screw to prevent intermittent contact between the cam screw and microprocessor (see "[Microprocessor Cam Screw](#)").

2. Tighten the cam screw.

➡ **NOTICE:** Do not over- or undertighten the screw. Tighten the screw until the screw indicator points to the "closed" or "locked" indicator on the socket.

3. Replace the microprocessor thermal-cooling assembly.

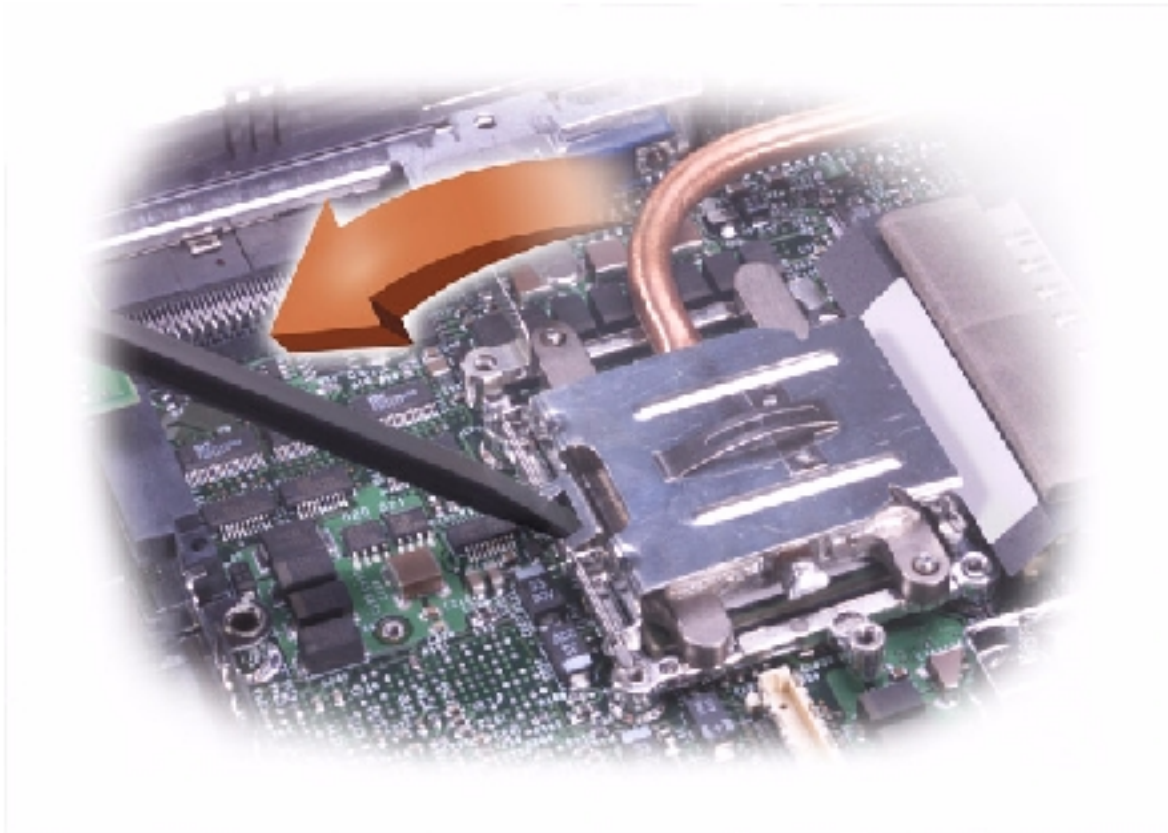

4. Close the microprocessor retaining clip.
5. To latch the clip, insert a flat-blade scribe into the latch mechanism and pivot the top of the scribe away from the clip.

[Back to Contents Page](#)

[Back to Contents Page](#)

Video Graphics Board

Dell™ Inspiron™ 8200

- ➔ **NOTICE:** Disconnect the computer and attached devices from electrical outlets and remove any installed batteries.
- ➔ **NOTICE:** To avoid ESD, ground yourself by using a wrist grounding strap or by periodically touching unpainted metal on the computer.

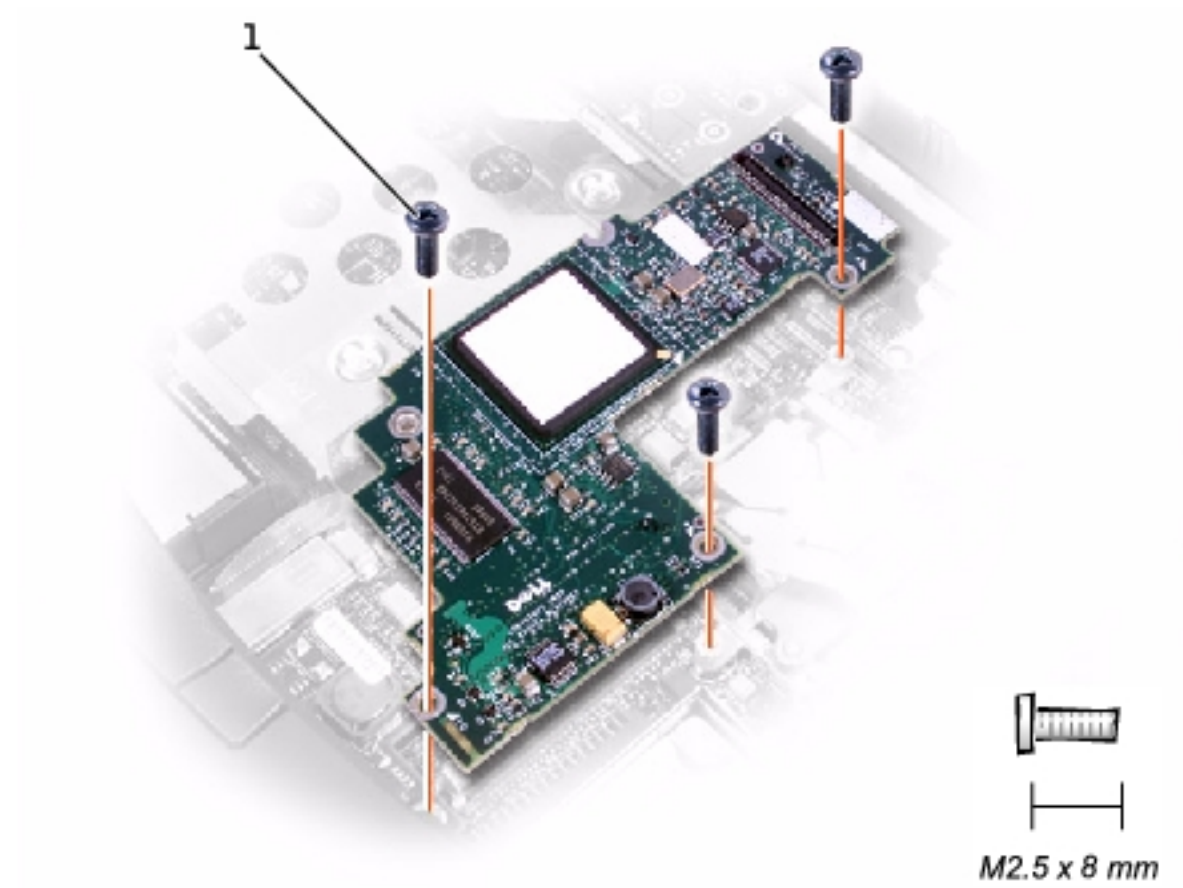

1	M2.5 x 8-mm screws (3)
---	------------------------

Removing the Video Graphics Board



NOTE: The video graphics board may have a flexible shield attached to it with an adhesive. The shield prevents electromagnetic interference with other electronic devices, such as cellular phones. Do not exchange or reuse the shield. Newer versions of the board may not require the shield; if a shield is required, it is already attached to the replacement board.

1. Follow the instructions in "[Preparing to Work Inside the Computer](#)."
2. Remove the [keyboard](#).
3. Remove the [hinge cover](#).
4. Detach the [display flex cable](#) from the strain relief and the graphics card.
5. Remove the three M2.5 x 8-mm screws that secure the video graphics board.
6. Separate the video graphics board from the system board connector.

Replacing the Video Graphics Board

1. Align the three screw holes and press down firmly on the word "Dell" to seat the board in its connector.



NOTICE: Ensure that the board is correctly and firmly seated before continuing. Failure to do so will cause intermittent video failures.

2. Replace the three M2.5 x 8-mm screws.

[Back to Contents Page](#)

[Back to Contents Page](#)

Palm Rest

Dell™ Inspiron™ 8200

- ➔ **NOTICE:** Disconnect the computer and attached devices from electrical outlets and remove any installed batteries.
- ➔ **NOTICE:** To avoid ESD, ground yourself by using a wrist grounding strap or by periodically touching unpainted metal on the computer.

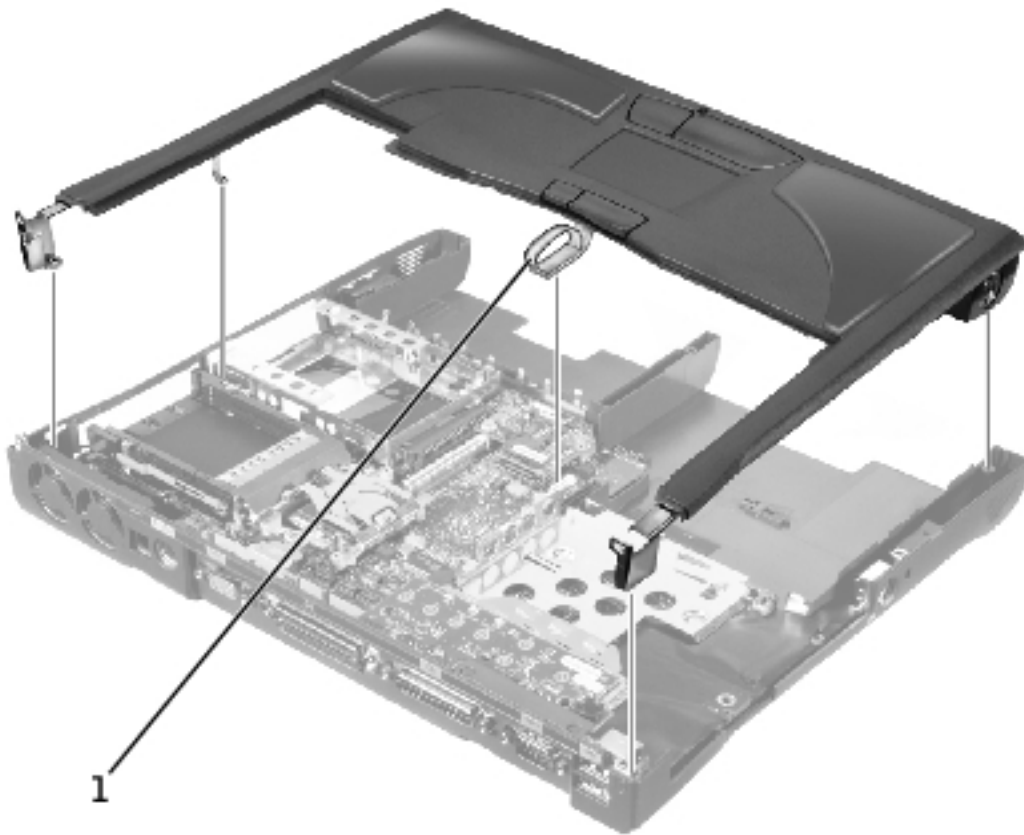

1	pull loop
---	-----------

-  **NOTICE:** The reserve battery provides power to the computer's time RTC and NVRAM when the computer is turned off. Removing the palm rest disconnects the reserve battery and causes the computer to lose the date and time information as well as all user-specified parameters in NVRAM. If possible, copy the information before you disconnect the reserve battery.

Removing the Palm Rest

1. Follow the instructions in "[Preparing to Work Inside the Computer](#)."
2. Remove the [hard drive](#) and the [fixed optical drive](#).
3. Remove the [keyboard](#).
4. Remove the [hinge cover](#).
5. Remove the [display assembly](#).

-  **NOTICE:** To avoid damaging the palm rest, you must first remove the display assembly.

6. Turn the computer over.
7. Remove the nine M2.5 x 20-mm screws (labeled "circle P") that secure the palm rest to the computer.

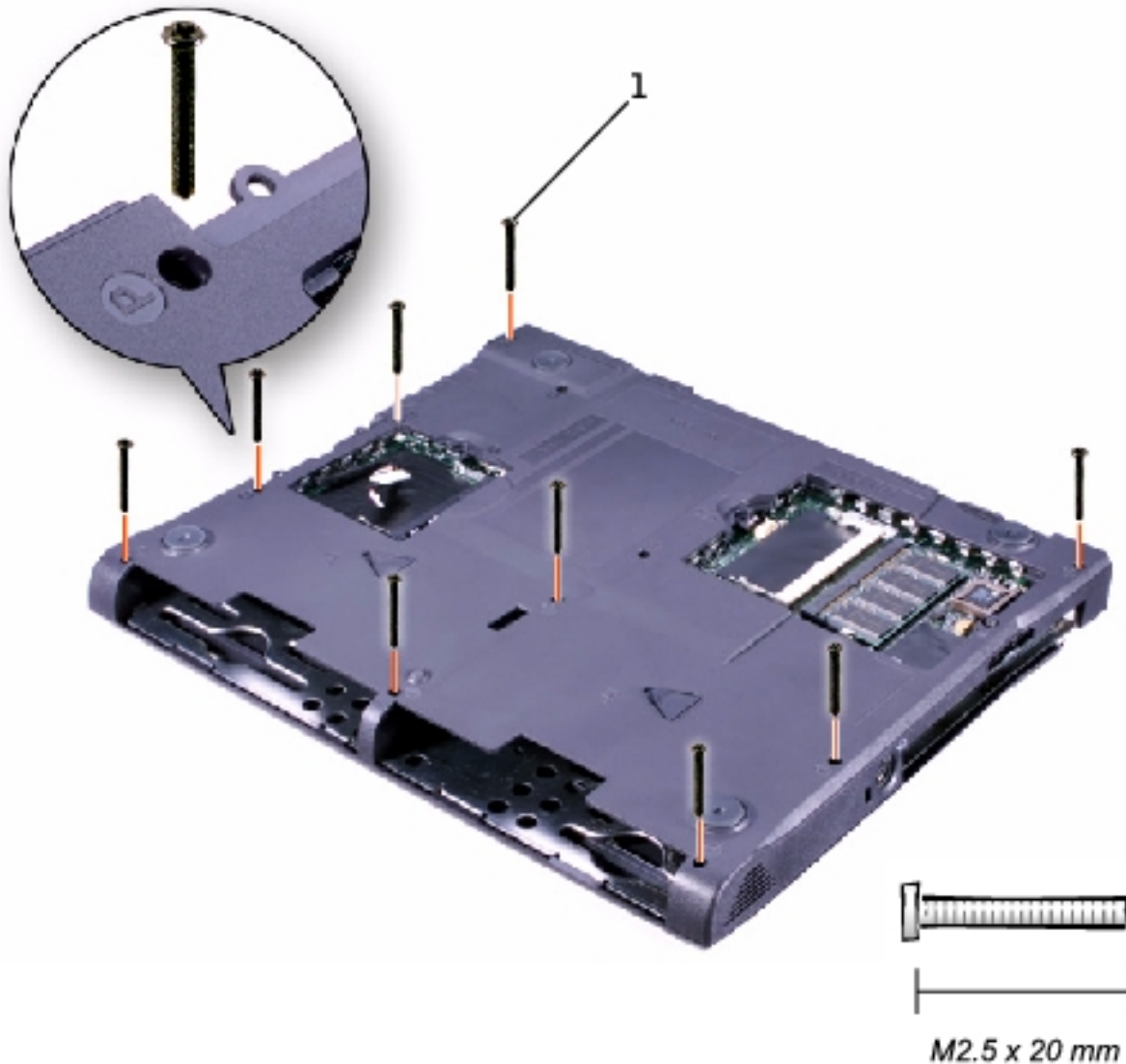

1	M2.5 x 20-mm screws (9)
---	----------------------------

8. Turn the computer over.
9. Use the pull loop to disconnect the palm-rest flex cable from the touch-pad connector on the system board.
10. On the left and right sides of the palm rest, use a flat-blade scribe between the palm rest and the bottom case of the computer to separate the snaps that secure the palm rest to the bottom case.
11. Lift out the palm rest.

Replacing the Palm Rest

When replacing the palm rest screws, install the two screws at the back corners of the computer first to help align the palm rest correctly.

[Back to Contents Page](#)

[Back to Contents Page](#)

Reserve Battery

Dell™ Inspiron™ 8200

- ➔ **NOTICE:** Disconnect the computer and attached devices from electrical outlets and remove any installed batteries.
- ➔ **NOTICE:** To avoid ESD, ground yourself by using a wrist grounding strap or by periodically touching unpainted metal on the computer.

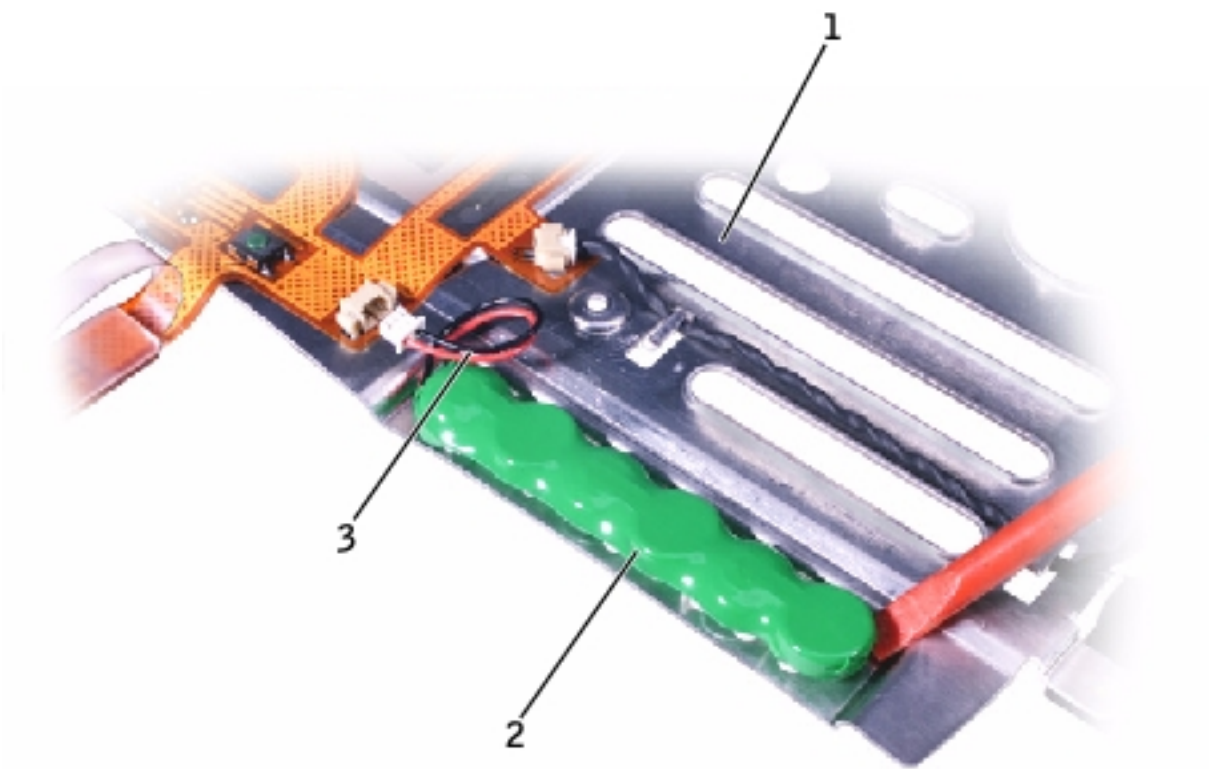

1	palm rest bracket
2	reserve battery
3	reserve battery cable

➔ **NOTICE:** The reserve battery provides power to the computer's RTC and NVRAM when the computer is turned off. Removing the battery causes the computer to lose the date and time information as well as all user-specified parameters in NVRAM. If possible, copy the information before you remove the reserve battery.

Removing the Reserve Battery

1. Follow the instructions in "[Preparing to Work Inside the Computer.](#)"
2. Remove the [keyboard](#).
3. Remove the [hinge cover](#).
4. Remove the [display assembly](#).
5. Remove the [palm rest](#).
6. On the underside of the palm rest, disconnect the palm-rest flex cable from the ZIF connector.

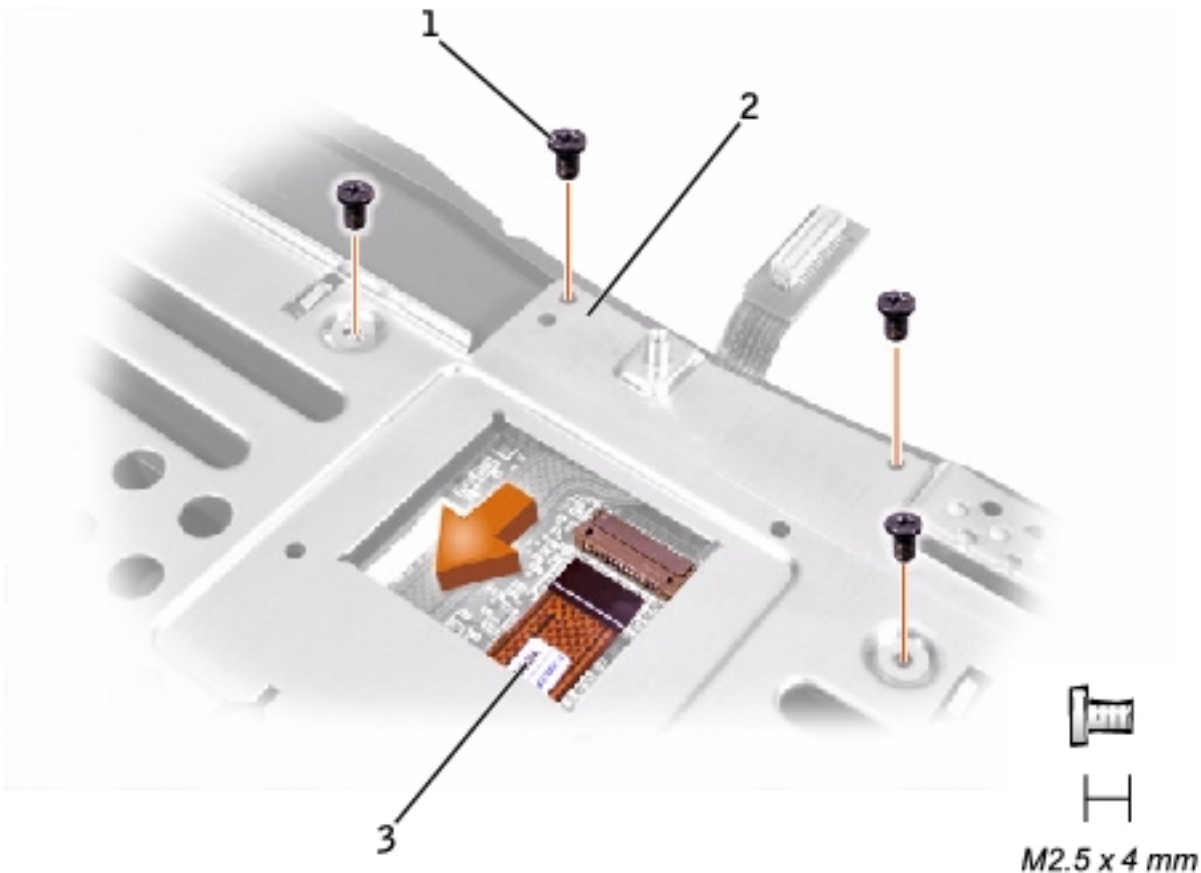

1	M2.5 x 4-mm screws (4)
2	palm rest bracket
3	palm-rest flex cable

7. Remove the four M2.5 x 4-mm screws that secure the palm rest bracket.
8. While supporting the palm-rest flex cable, lift out the palm rest bracket and turn it over.
9. Disconnect the reserve battery cable.
10. Remove the reserve battery:
 - a. Pry the reserve battery free from the metal palm rest bracket.
 - b. Remove the foam-pad remnants from the palm rest bracket.

Replacing the Reserve Battery

1. Seat the reserve battery and press it into place.
2. Connect the reserve battery cable.
3. Place the palm rest bracket loosely in the palm rest, and connect the palm-rest flex cable to the ZIF connector.
4. Replace the four M2.5 x 4-mm screws that secure the palm rest bracket to the palm rest.

[Back to Contents Page](#)

[Back to Contents Page](#)

System Board

Dell™ Inspiron™ 8200

➔ **NOTICE:** Disconnect the computer and attached devices from electrical outlets and remove any installed batteries.

➔ **NOTICE:** To avoid ESD, ground yourself by using a wrist grounding strap or by periodically touching unpainted metal on the computer.

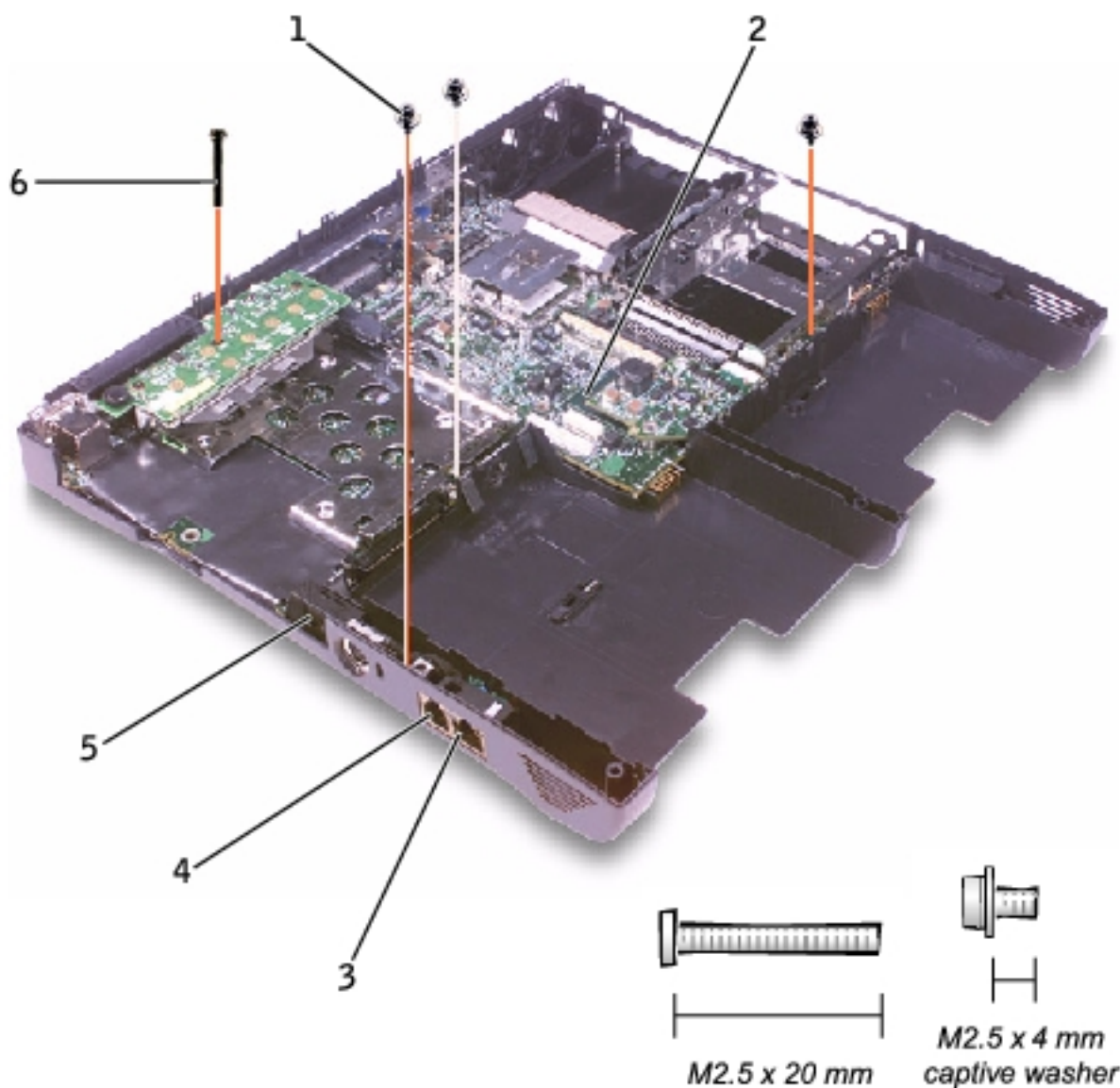

1	M2.5 x 4-mm captive-washer screws (3)
---	---------------------------------------

2	system board
3	network connector
4	modem connector
5	network cable cover
6	M2.5 x 20-mm screw

The BIOS chip on the system board contains the service tag sequence, which is also visible on a bar code label on the bottom of the computer.

The replacement kit for the system board includes a floppy disk or CD that provides a utility for transferring the service tag sequence to the replacement system board.

 **NOTICE:** If you received a flash BIOS update program floppy disk or CD with the replacement microprocessor, you must update the BIOS after replacing the microprocessor module.

Removing the System Board

1. Follow the instructions in "[Preparing to Work Inside the Computer](#)."
2. Remove the [hard drive](#) and the [fixed optical drive](#).
3. Remove any installed [Mini PCI Cards](#).
4. If migrating the memory, remove all installed [memory modules](#).
5. Remove (if migrating) or disconnect the [modem daughter card](#).
6. Remove the [keyboard](#).
7. Remove the [hinge cover](#).
8. Remove the [display assembly](#).
9. Remove the [palm rest](#).
10. Remove the [video graphics board](#).
11. Remove the [microprocessor thermal-cooling assembly](#).

12. If migrating the microprocessor, remove the [microprocessor module](#).
13. Separate the network cable from the system board:
 - a. First remove the network cable cover: Insert a narrow plastic scribe or small screwdriver just barely into the slot that faces the back of the computer (do not insert the scribe far enough to catch on the wires inside), press down on the cover lightly to secure it, and pry upward to release the cover.

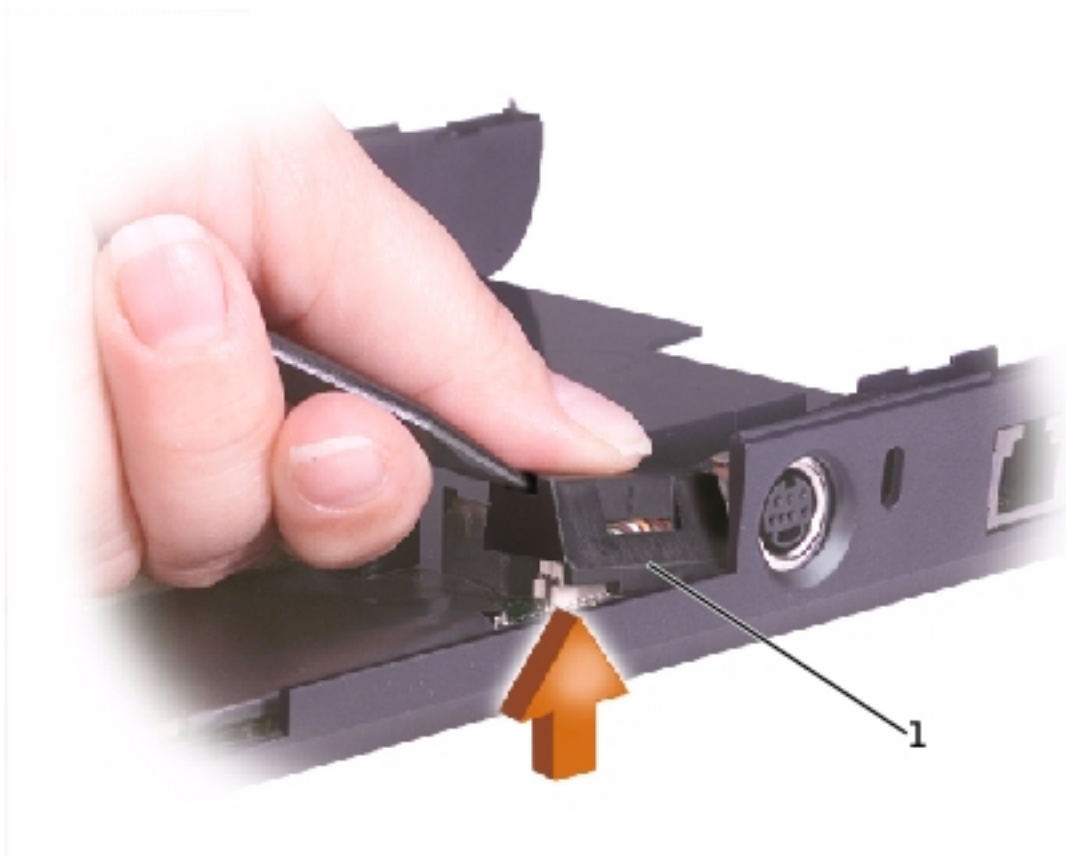

1	network cable cover
---	---------------------

- b. Disconnect the network cable. Do not pull on the cable wires. Instead, pry up the outer corner of the upper connector until the connectors start to separate.

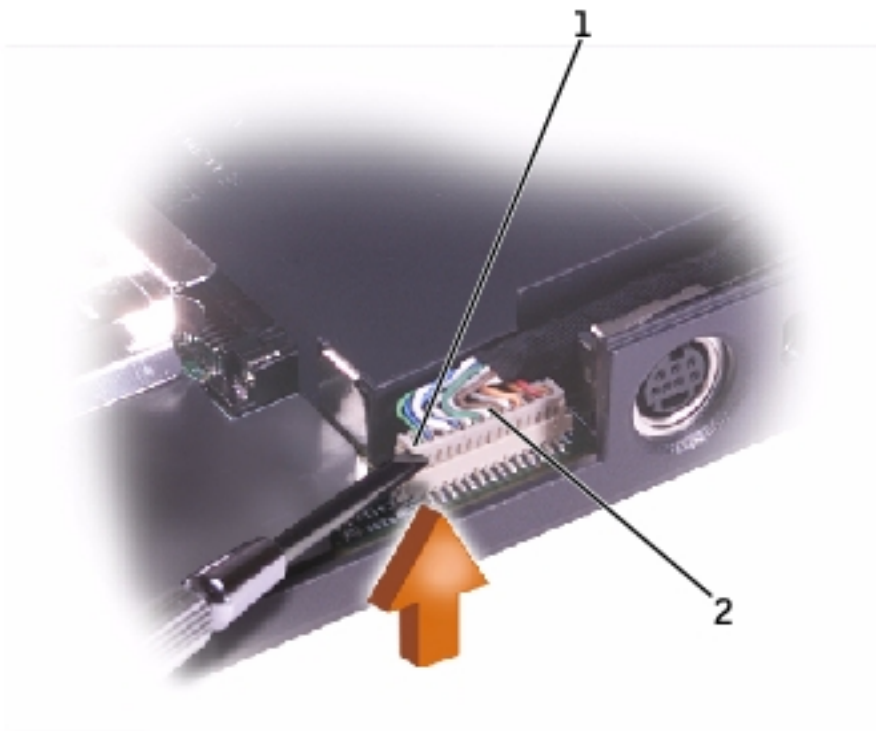

1	outer corner of upper connector
---	---------------------------------

2	network cable
---	---------------

14. Remove the three M2.5 x 4-mm captive-washer screws from the system board.
15. Remove the M2.5 x 20-mm screw from the center of the LED board.
16. Lift the front of the system board and work it out of the back panel.

If necessary to help release the system board, pull outward on the top of the plastic near the back left corner of the bottom case (see the small arrow at the far left in the following figure).



[Back to Contents Page](#)

[Back to Contents Page](#)

Battery and Module Bay Latches

Dell™ Inspiron™ 8200

- ➔ **NOTICE:** Disconnect the computer and attached devices from electrical outlets and remove any installed batteries.
- ➔ **NOTICE:** To avoid ESD, ground yourself by using a wrist grounding strap or by periodically touching unpainted metal on the computer.

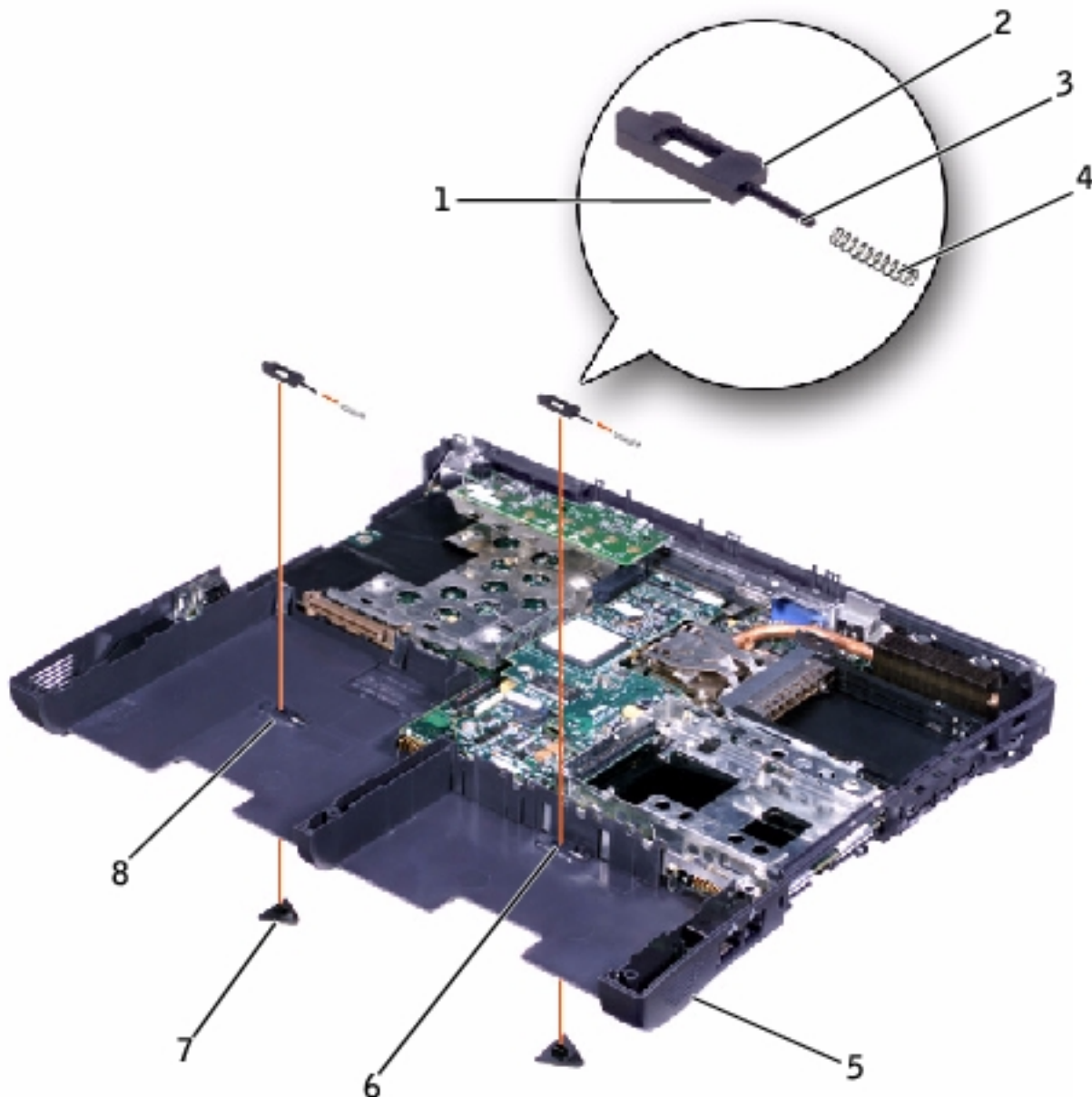

1	wear ribs (2 on underside)
2	bumps
3	slider
4	spring
5	bottom case
6	latch housing (2)
7	latch buttons (2)
8	location of snap tabs (2)

Removing and Replacing the Battery and Module Bay Latches

1. Follow the instructions in "[Preparing to Work Inside the Computer](#)."
2. Remove the [keyboard](#).
3. Remove the [hinge cover](#).
4. Remove the [display assembly](#).
5. Remove the [palm rest](#).
6. Remove a latch button from the bottom case by squeezing the snap tabs in the center of the latch.

Tape over or hold down the upper latch assembly (spring and slider) to hold the assembly in place. Apply downward pressure to the snap tabs while squeezing them together (tweezers work well) to eject the latch button from the underside of the bottom case without loosening the upper latch assembly. If the upper latch assembly does come loose:

- a. Slide the spring onto the slider, and reinstall both pieces in the latch housing on the inside of the bottom case.

- b. Ensure that the slider is inserted so that the side with the two bumps is facing the back of the bottom case, and the surface with the wear ribs lies against the upper surface of the bottom case.**

- 7. Hold the upper latch assembly in place while you snap the new latch button in from underneath the bottom case, making certain the snap tabs are fully engaged in the slider.**

Ensure that the newly installed latch assembly moves smoothly and freely when pushed and released.

[Back to Contents Page](#)

[Back to Contents Page](#)

Battery Charger Board

Dell™ Inspiron™ 8200

- ➔ **NOTICE:** Disconnect the computer and attached devices from electrical outlets and remove any installed batteries.
- ➔ **NOTICE:** To avoid ESD, ground yourself by using a wrist grounding strap or by periodically touching unpainted metal on the computer.

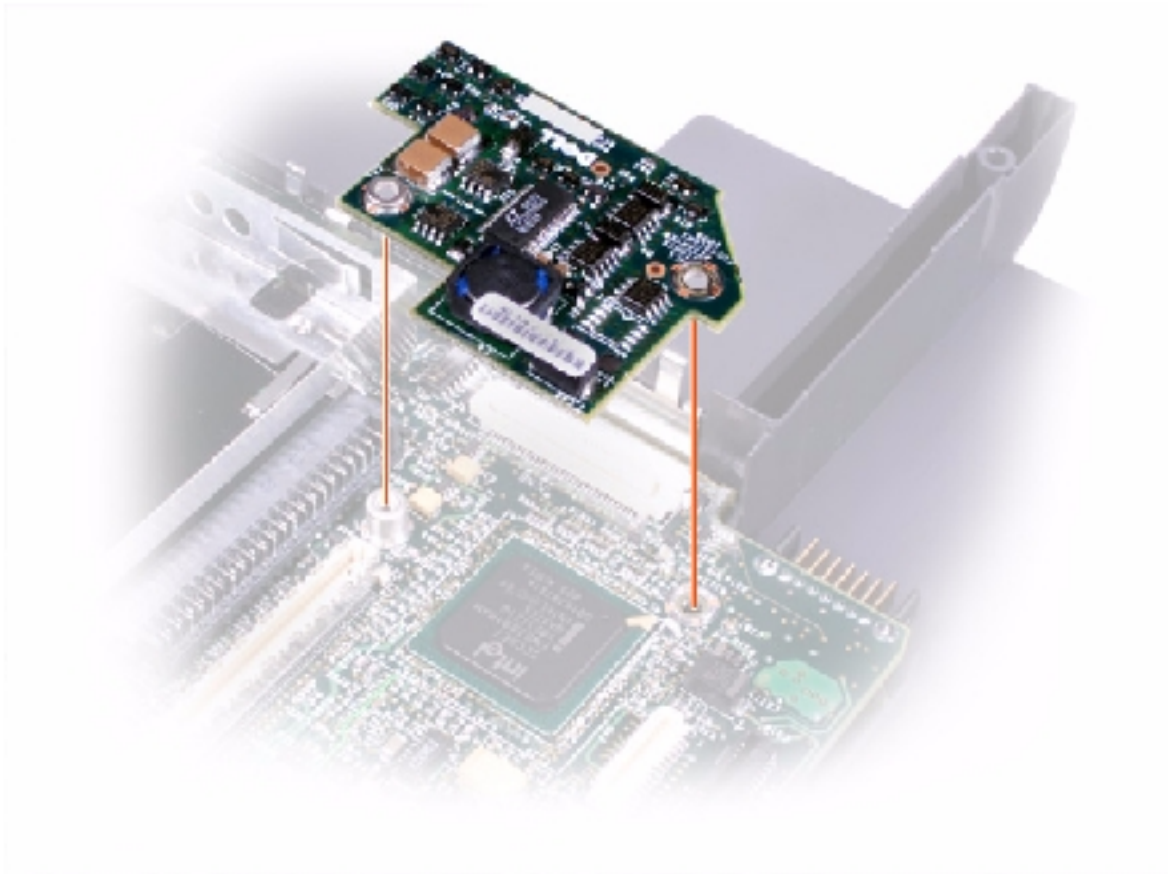

Removing the Battery Charger Board

1. Follow the instructions in "[Preparing to Work Inside the Computer.](#)"
2. Remove the [keyboard](#).
3. Remove the [hinge cover](#).

4. Remove the [display assembly](#).
5. Remove the [palm rest](#).
6. Remove the [video graphics board](#).
7. Lift the battery charger board out of the system board connector.

Replacing the Battery Charger Board

Align the screw holes on the battery charger board with the screw holes on the bottom case, and then press the battery charger board down into its connector.

[Back to Contents Page](#)

[Back to Contents Page](#)

LED Board

Dell™ Inspiron™ 8200

- ➔ **NOTICE:** Disconnect the computer and attached devices from electrical outlets and remove any installed batteries.
- ➔ **NOTICE:** To avoid ESD, ground yourself by using a wrist grounding strap or by periodically touching unpainted metal on the computer.

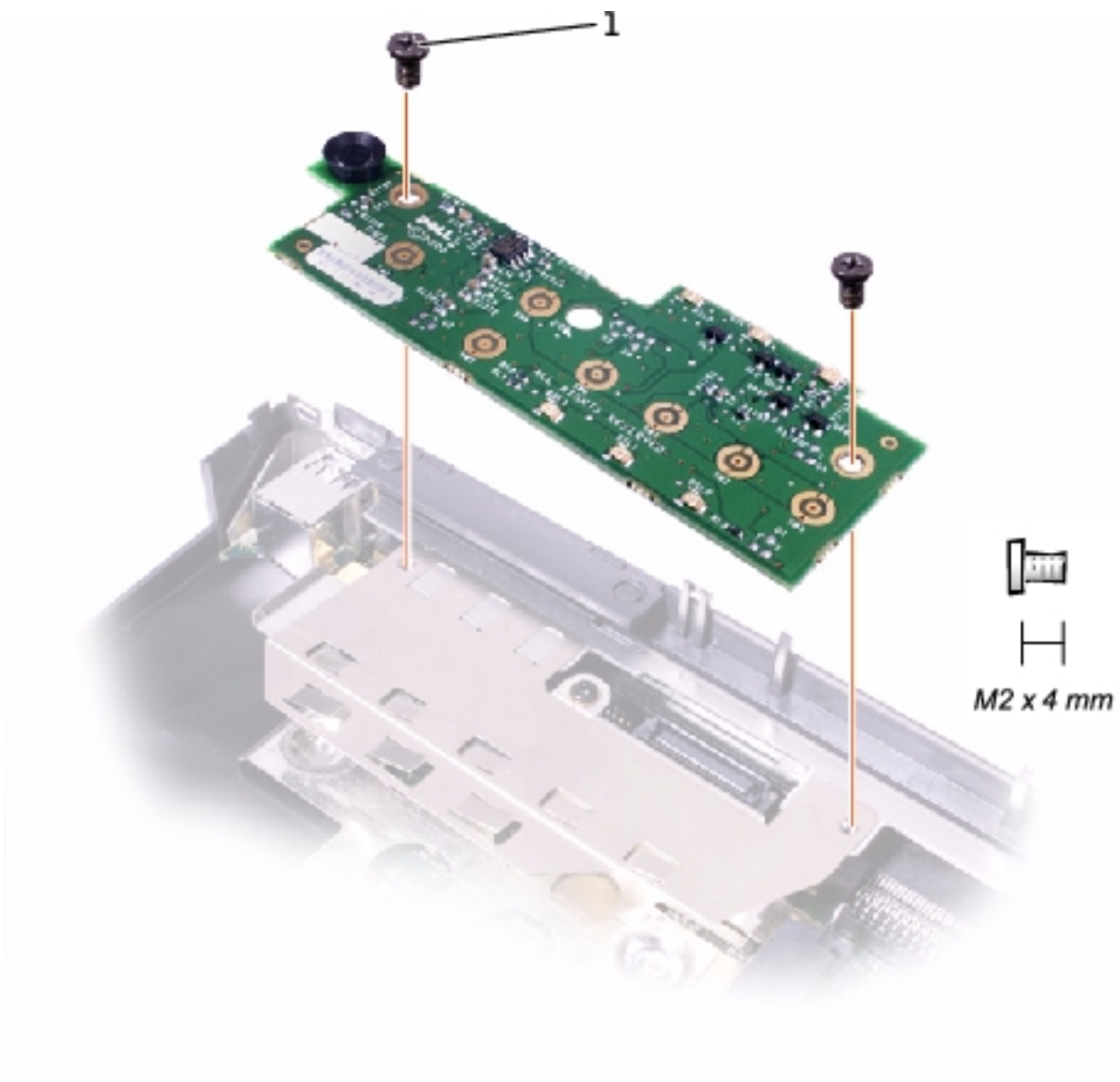

1	M2 x 4-mm screws (2)
---	----------------------

Removing the LED Board

1. Follow the instructions in "[Preparing to Work Inside the Computer.](#)"
2. Remove the [hinge cover](#).
3. Remove the two M2 x 4-mm screws.
4. Lift the LED board away from its connector.

Replacing the LED Board

1. Align the two screw holes with the two mounting holes on the bottom case, and press the board into its connector.
 2. Replace the two M2 x 4-mm screws.
-

[Back to Contents Page](#)

[Back to Contents Page](#)

Fan

Dell™ Inspiron™ 8200

- ➔ **NOTICE:** Disconnect the computer and attached devices from electrical outlets and remove any installed batteries.
- ➔ **NOTICE:** To avoid ESD, ground yourself by using a wrist grounding strap or by periodically touching unpainted metal on the computer.



1	fan cables
2	M2 x 4-mm screws (3)

Removing the Fan

1. Follow the instructions in "[Preparing to Work Inside the Computer.](#)"

2. Remove the [system board](#).
3. Remove the three M2 x 4-mm screws from the fan.
4. Disconnect the two fan cables from the system board.
5. Pull the fan away from the back-panel bracket.



NOTICE: When reconnecting the fan cables, connect the shorter cable to the connector closest to the fan. Route both cables so that they will not be pinched by the microprocessor thermal-cooling assembly.

[Back to Contents Page](#)

[Back to Contents Page](#)

RJ- 11 /RJ-45 Module

Dell™ Inspiron™ 8200

- ➔ **NOTICE:** Disconnect the computer and attached devices from electrical outlets and remove any installed batteries.
- ➔ **NOTICE:** To avoid ESD, ground yourself by using a wrist grounding strap or by periodically touching unpainted metal on the computer.

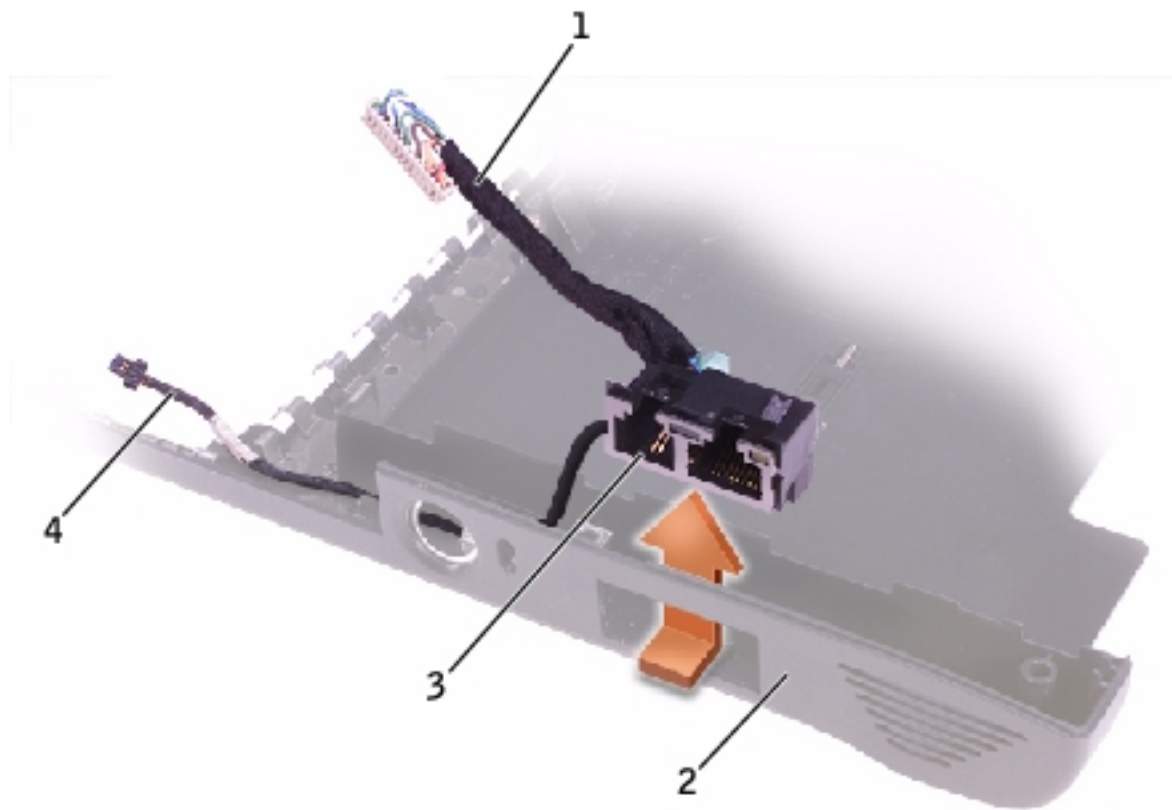

➔ **NOTICE:**

1	network cable
2	bottom case
3	RJ- 11/RJ-45 module
4	modem cable

Removing the RJ-11/RJ-45 Module

1. Follow the instructions in "[Preparing to Work Inside the Computer.](#)"
2. Remove the [system board](#).
3. From outside the bottom case, push in and up on the RJ-11/RJ-45 module while pulling the side of the bottom case slightly outward. When the module disengages, lift it out.

Replacing the RJ-11/RJ-45 Module

When replacing the RJ-11/RJ-45 module, hold both cables safely out of the way and snap the housing down into place. Then route the modem cable through the vertical slot, through the appropriate posts, and out through the corner of the memory module/modem cutout.

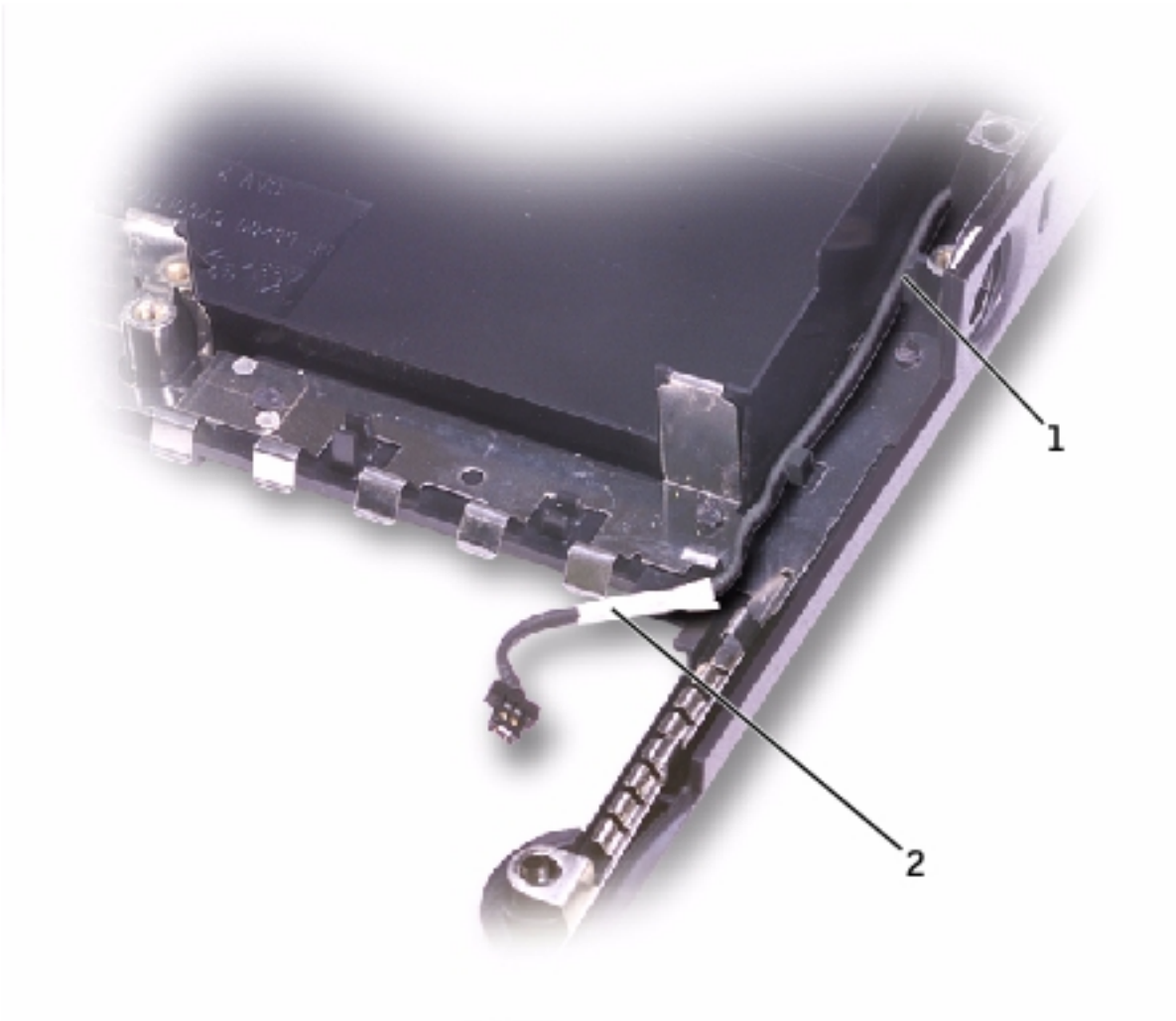

1	vertical slot
2	modem cable

When replacing the system board, ensure that the network cable is safely above the board and out of the way.

[Back to Contents Page](#)