

# CONTENTS

<b>INDEX.....</b>	<b>A</b>
<b>HOW TO USE THIS MANUAL.....</b>	<b>2</b>
<b>INTRODUCTION TO THE ATC-6510 MAINBOARD HARDWARE.....</b>	<b>3</b>
<b>INSIDE THE ATC-6510 MAINBOARD PACKAGE.....</b>	<b>4</b>
<b>CHAPTER 1 Introduction.....</b>	<b>5</b>
1-1 Soft-Off-Control.....	5
1-2 LDCM ( LANDesk Client Manager, option).....	6
1-3 Thermister (option).....	7
1-4 Wake-On-LAN.....	7
1-5 SB-Link Sideband Signals (JP3).....	8
<b>CHAPTER 2 Installation.....</b>	<b>9</b>
2-1 Installation Procedure .....	9
2-2 CPU Installation.....	10
2-3 System Memory Installation.....	16
2-4 Connectors Description.....	17
2-5 IDE Driver Installation.....	22
<b>CHAPTER 3 Award BIOS Setup .....</b>	<b>23</b>
3-1 Update BIOS Procedure .....	24
3-1-1 Update Pentium II microcode API.....	25
3-2 Award System BIOS Configuration Setup .....	26
<b>Appendix A .....</b>	<b>56</b>
<b>Appendix B How to Install Pentium II CPU ? &amp; How to Install Celeron CPU ?</b>	
<b>Appendix C How to Setup Thermister (option) ?</b>	

## HOW TO USE THIS MANUAL

**To obtain maximum use from this manual it is suggested:**

**Read Page A COMPONENT LOCATION DIAGRAM** where you find the mainboard layout diagram. Please refer to it when you configure the system.

Read about an overview of the mainboard features, packing contents, and how to upgrade as well as to change hardware configurations such as memory size, CPU type, jumper settings lists and connectors in the following categories:

**INTRODUCTION TO THE ATC-6510 MAINBOARD HARDWARE  
INSIDE THE ATC-6510 MAINBOARD PACKAGE**

**Chapter 1 Introduction**

**Chapter 2 Installation**

When you have finished reading of both chapter 1 and chapter 2, turn to **Chapter 3 Award BIOS Setup** where you will find the update BIOS procedure and the further information which is stored in the SETUP is the system hardware configuration.

The back of this manual contains **APPENDIX A** which is a list of request form for technical support, **APPENDIX B** which shows you how to setup Pentium II CPU and **APPENDIX C** which shows you how to setup thermister.

Your system dealer will set up the mainboard according to your demand of the computer. It means that the current settings of your mainboard may not be the same as the defaults shown in this user's manual. If you need to change your configuration, please ask your dealer first. Be sure this will not void your system warranty, or ask your dealer to do it for you.

**REMARK**

Intel® is a registered trademark of Intel Corporation.

All other brands and product names are trademarks registered trademarks of their respective companies.

## **INTRODUCTION TO THE ATC-6510 MAINBOARD**

# HARDWARE

Each ATC-6510 mainboard supports or contains the following components:

- 🖥️ INTEL Pentium II CPU operating from 233MHz up to 333MHz.
- 🖥️ INTEL Celeron™ CPU operating from 266MHz up to 333MHz.
- 🖥️ INTEL 440EX PCIset.
- 🖥️ ATI AGP Rage IIC 3D VGA chipset.
- 🖥️ Yamaha 719/715 IIC 3D stereo sound PnP chipset, optional for ATI AGP Rage Pro 3D.
- 🖥️ Using two 168-pin DIMM sockets, provides two banks of 64-bit wide path up to 256MB SDRAM or 256 EDO DRAM (with parity chip ECC support).
- 🖥️ Built-in Switching Voltage Regulator.(VRM 8.2 SPEC.)
- 🖥️ INTEL LDCM software.(option)
- 🖥️ Supports auto-detect CPU core voltage range 1.8V to 3.5V.
- 🖥️ Supports one AGP slot, three PCI slots with revision 2.1 interface compliant and one 16-bit ISA slot.
- 🖥️ Dual Master IDE connectors support Ultra DMA/33, up to four devices in two channels for connecting of high capacity hard drive, CD-ROM disk drive, tape backup etc..
- 🖥️ Supports the USB (Universal Serial Bus) connector.
- 🖥️ PS/2 keyboard connector and PS/2 mouse connector.
- 🖥️ Winbond 83977 high-speed Ultra Multi-I/O chipset.
- 🖥️ Supports Infrared transfer (IrDA TX/RX) connection.
- 🖥️ One FDC port supports two devices up to 2.88MB.
- 🖥️ Two 16550A fast UARTs compatible serial ports.
- 🖥️ One EPP/ECP mode parallel printer port.
- 🖥️ Built-in Hardware Health Monitoring. (option)
- 🖥️ Built-in SGRAM optional for 2MB, 4MB, 8MB; default value is 4MB.
- 🖥️ Hardware Dimension is 244mm x 244mm. (9.6" x 9.6")

## INSIDE THE ATC-6510 MAINBOARD PACKAGE

The mainboard comes securely packed in a durable box and shipping carton. If any of the following items are missing or damaged, please contact your supplier.

Each mainboard contains:

<u>Q'TY</u>	<u>Description</u>
1	Mainboard : ATC-6510.
1	Retention mechanism (for Pentium II installation)
1	CD(option) : LDCM, Enhanced IDE driver Award system BIOS Update Utility
1	Diskette(option) : Enhanced IDE driver Award system BIOS Update Utility
1	Cable : Thermister cable (option).
1	Cable : Enhanced IDE cable.
1	Cable : F.D.D. cable.
1	Manual : User manual. (English version)
1	English LDCM user manual (option)

## **CHAPTER 1 INTRODUCTION**

The ATC-6510 mainboard has ATI AGP Rage IIC 3D VGA chipset, Yamaha 719/715 IIC 3D stereo sound PnP chipsets and SGRAM (option) onboard. The ATI AGP Rage IIC 3D VGA chipset using AGP interface technique which allows users could have 3D display resolution without plug any of VGA cards and the Yamaha 719/715 IIC 3D stereo sound PnP chipset using ISA interface which could let your system has 3D stereo sound. With 2MB SGRAM onboard, the mainboard can play large volume games. If your mainboard built-in 4MB SGRAM, your system can perform more powerful gamers e.g. 3D games. The 8 SGRAM onboard is to provide users who need running volume CAD software.

## 1-1 SOFTWARE POWER OFF CONTROL

The mainboard design supports Software Power Off Control feature through the SMM code in the BIOS under Windows 95, and MS-DOS operation system environment. This is Intel ATX form factor feature and you should use ATX power supply.

First, you should connect the power switch cable (provided by the ATX case supplier) to the connector “PS-ON” on the mainboard. In the BIOS screen of POWER MANAGEMENT SETUP’, choose “User Defined” (or “Min. Power Saving” or “Max. Power Saving”) in ‘Power Manager’ and choose “Yes” in ‘PM Control by APM’.

In Windows 95, if you would like to power off the system, you just choose “shutdown the computer ?” in the “Shut Down Windows“ from Windows 95, then the system power will be off directly, and become the stand-by status. You will find the power LED light is not blinking (**see the table below for the operating status**). If you would like to restart the system, just press the power switch button, and the system will be powered on.

Note : If you will leave your system for several days, we suggest you use hardware power off to shutdown your system.

Status	Power LED Light	Turbo LED Light
Software power off control	Light off	Light off
APM mode	Blinking	Light on
System running	Light on	Light on

## 1-2 LDCM ( LANDesk Client Manager ) (option)

ATC-6510 built-in controller(option) support Intel LDCM. LDCM can satisfy users who want manageable systems that can interact automatically with the user. Client manager is the answer, enabling both administrators and clients to manage systems. The features of LDCM are as following :

### **View system inventory**

Client Manager enables you to view hundreds of inventoried items. Some of these items are software related, while many others are hardware related.

### **View DMI-compliant component information**

Client manager enables you to view component information that is compliant with the Desktop Manager Interface ( DMI ) . This means you can manage third-party DMI-compliant components not included with Client manager.

### **Back up and restore system configuration files.**

Client Manager enables you back up and restore system configuration files. Whenever you plan on changing the system configuration , you can make a backup set. If the system no longer works correctly, after you change the system configuration , you can simply restore the system configuration with the backup set.

### **Troubleshoot**

Since Client manager enables you to view the system inventory, you can easily troubleshoot system problems.

### **Receive notifications for system events**

Client manager enables you to receive notification of certain system events. For example, if the system is running low on virtual memory, you are notified of the potential problem.

### **Transfer files to and from client workstations**

As an administrator, you have the ability to transfer files to and from client workstation. This is helpful, for example, when you need to update a client workstation driver.

### **Remotely reboot client workstations**

Administrator also have the ability to remotely reboot a workstation . This is helpful when you want your system configuration settings to take effect.

## 1-3 Thermister (option)

This means that users can monitor the CPU temperature through thermister. When setting up the thermister, the BIOS will load the CPU temperature automatically. There is a choice of the warning beep sound if users set the option on. If the CPU temperature overheated, users will get the notice from the thermister. This time you should shut down computer and check your devices. Consequently, protecting and monitoring the CPU temperature is the thermister's job.

## 1-4 Wake-On-LAN

The remote Wake-On-LAN mode of operation is a mechanism that uses Advanced Micro Device Magic Packet technology to power up a sleeping workstation on the network. This mechanism is accomplished when the LAN card receives a specific packet of information, called a Magic Packet, addressed to the node on the network. For additional protection, Secure ON is an optional security feature that can be added to the Magic Packet that requires a password to power up the sleeping workstation. When the LAN card is in remote Wake-On-LAN mode, main system power can be shut down leaving power only for the LAN card and auxiliary power recondition.

The LAN card performs no network activities while in the remote Wake-On-LAN mode of operation. It only monitors the network for receipt of a Magic Packet. If a Magic Packet is addressed to the LAN card on the network, the LAN card wake up the system. If the Secure ON feature has been enabled, the password added to the Magic Packet is also verified prior to waking up the system.

WOL LAN card will provide a 3-pin line to connect the WOL connector on the mainboard.

### CAUTION :

For Wake-on-LAN, the +5V standby line for the power supply must capable of Delievring +5V  $\pm$  5% at 720mA. Failure to provide adequate standby current when implementing Wake-on-LAN, can damage the power supply.

Before you enable Wake-on-LAN function, first check your power supply specification to meet the above requirement or not.

## 1-5 SB-LINK Sideband Signals (JP3)

In order to migrate the legacy Sound Blaster compatible audio to the PCI bus, EMU8008 incorporates a pair of SB-Link request/grant sideband signals (PCPCIR EQ#A and PCPCISIRQ) to interface to the PCI bus. SB-Link is a mechanism that was defined and developed by Creative as a docking solution which allows ISA slots to exist in docking stations connected to desktop PC PCI bus.

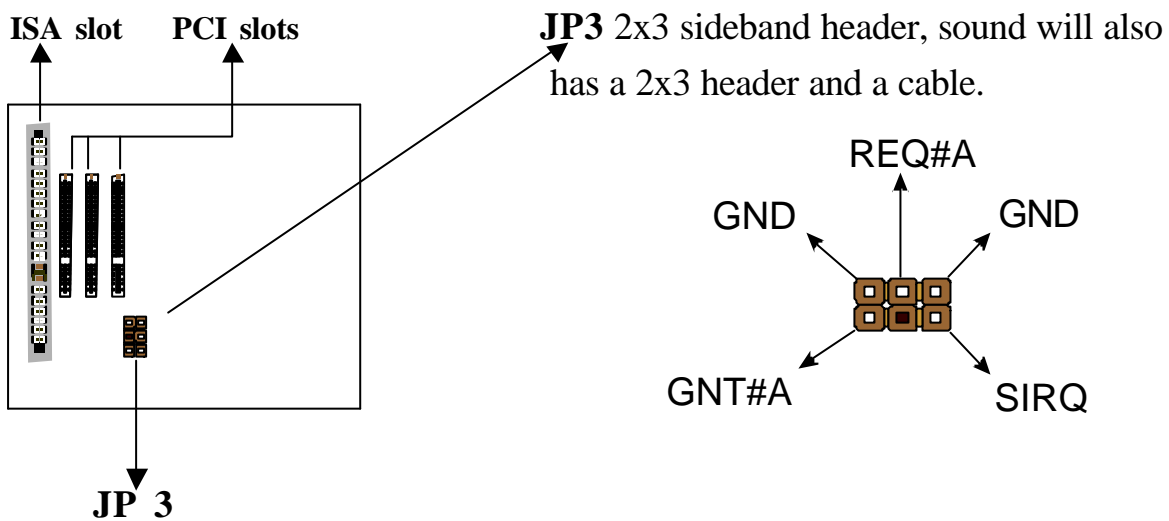



# CHAPTER 2 INSTALLATION

## 2-1 INSTALLATION PROCEDURE

Before installing the computer, please prepare all components such as CPU, DRAM; peripherals such as hard drive, keyboard, CD-ROM disk drive and accessories such as cables. Then, install the system as following:

1. Plug CPU/ heat sink (refer to Pentium II installation guide, **Appendix A**), and DRAM modules on the mainboard.
2. Set DIP switch based on your configuration.
3. Plug add-on cards into PCI/ISA slots, if needed.
4. Connect cables to peripherals, specially for VGA and Sound connector.
5. Make sure all components and devices are well connected, turn on the power and setup System BIOS based on your configuration.
6. Install peripherals, add-on card drivers and test them.
7. If all of above procedures are success, turn-off the power then plug all of them into your computer case.

### **Remark :**

**Before you do the mainboard installation, please keep in mind that VGA and Sound chipsets are built-in on the ATC-6510 mainboard along with MicroATX Form Factor.**

## 2-2 CPU INSTALLATION

The 6510 mainboard supports both INTEL Pentium II CPU and Celeron CPU.

### 2-2-1 CPU TYPE SELECTION (by BIOS)

1. Press the <Del> key when the system is booting up.
2. The following main menu will appear.

ROM PCI/ISA BIOS (ATC-6510)  
CMOS SETUP UTILITY  
AWARD SOFTWARE, INC.

STANDARD CMOS SETUP	INTEGRATED PERIPHERALS
BIOS FEATURES SETUP	SUPERVISOR PASSWORD
CHIPSET FEATURES SETUP	USER PASSWORD
POWER MANAGEMENT SETUP	IDE HDD AUTO DETECTION
PNP/PCI CONFIGURATION	SAVE & EXIT SETUP
LOAD BIOS DEFAULTS	EXIT WITHOUT SAVING
LOAD SETUP DEFAULTS	
ESC: Quit	↑↓→←:Select Item
F10: Save & Exit Setup	(Shift) F2 : Change Color
AT Clock, DRAM Timings, .....	

3. Select “CHIPSET FEATURES SETUP”

STANDARD CMOS SETUP	INTEGRATED PERIPHERALS
BIOS FEATURES SETUP	SUPERVISOR PASSWORD
<b>CHIPSET FEATURES SETUP</b>	USER PASSWORD
POWER MANAGEMENT SETUP	IDE HDD AUTO DETECTION
PNP/PCI CONFIGURATION	SAVE & EXIT SETUP
LOAD BIOS DEFAULTS	EXIT WITHOUT SAVING
LOAD SETUP DEFAULTS	
ESC: Quit	↑↓→←:Select Item
F10: Save & Exit Setup	(Shift) F2 : Change Color
AT Clock, DRAM Timings, .....	

**4. Then the following screen will appear.**

ROM PCI/ISA BIOS (ATC-6510)  
 CHIPSET FEATURES SETUP  
 AWARD SOFTWARE, INC.

Auto Configuration	: Enabled	SDRAM CAS latency Time	: 3
DRAM Speed Selection	: 60 ns	CPU Clock Ratio	: 2.0x
MA Wait State	: Slow	Auto Detect DIMM/PCI Clk	: Enabled
EDO RAS# To CAS# Delay	: 3	CPU Clock Frequency	: 66MHz
EDO RAS# Precharge Time	: 3	Spread Spectrum Modulated	: Disabled
EDO DRAM Read Burst	: x333	<b>*Following menus are optional*</b>	
EDO DRAM Write Burst	: x222	*CPU Warning Temperature	: Disabled
CPU-To-PCI IDE Posting	: Disabled	*Current System Temperature	: 20 °C/ 68 °F
System BIOS Cacheable	: Disabled	*Current CPU Temperature	: 20 °C/ 68 °F
Video BIOS Cacheable	: Disabled	*Current ChassisFAN Speed	: 0 PRM
Video RAM Cacheable	: Disabled	*Current PWRFAN Speed	: 0 PRM
8 Bit I/O Recovery Time	: 3	*Current CPUFAN Speed	: 0 RPM
16 Bit I/O Recovery Time	: 2	*Vcore : 2.80V	VTT(V) : 1.47V
Memory Hole At 15M-16M	: Disabled	*+3.3V : 3.45V	+5V : 4.91V
Passive Release	: Enabled	*+12V : 12.22V	-12V : -11.76
Delayed Transaction	: Disabled	*-5V : -5.16V	
AGP Aperture Size (MB)	: 128	Esc: Quit	↑↓→←:Select Item
SDRAM RAS-to-CAS Delay	: Slow	F1 : Help	PU/PD/+/-:Modify
SDRAM RAS Precharge Time	: Slow	F5 : Old Values	(Shift)F2 :Color
		F6 :Load BIOS Defaults	
		F7 :Load Setup Defaults	

**NOTE**

**If an incorrect CPU frequency is set through the BIOS, a system failure may occur. This system failure can be solved by pressing the “Insert” key on the keyboard to clear up the previous set frequency (i.e. back to 133MHz (66MHz x 2.0) or the default frequency), and then the power button to restart the system and reset the value in BIOS screen. Or user can clear CMOS to reset the BIOS value.**

**Also the ATC-6510 mainboard supports keyboard power on or mouse power on function, (refer to ‘Integrated Peripherals’, page48,49). When you set ‘keyboard power on’, you can select set password or not. When you set password, you should key-in the password to power on the system. If you forget the password, you should clear CMOS to reset the system.**

**5a. Intel Pentium II 233MHz (66 x 3.5)**

ROM PCI/ISA BIOS (ATC-6510)  
 CHIPSET FEATURES SETUP  
 AWARD SOFTWARE, INC.

Auto Configuration	: Enabled	SDRAM CAS latency Time	: 3
DRAM Speed Selection	: 60 ns	CPU Clock Ratio	: 3.5x
MA Wait State	: Slow	Auto Detect DIMM/PCI Clk	: Enabled
EDO RAS# To CAS# Delay	: 3	CPU Clock Frequency	: 66MHz
EDO RAS# Precharge Time	: 3	Spread Spectrum Modulated	: Disabled
EDO DRAM Read Burst	: x333	<b>*Following menus are optional*</b>	
EDO DRAM Write Burst	: x222	*CPU Warning Temperature	: Disabled
CPU-To-PCI IDE Posting	: Disabled	*Current System Temperature	: 20 ° C/ 68 ° F
System BIOS Cacheable	: Disabled	*Current CPU Temperature	: 20 ° C/ 68 ° F
Video BIOS Cacheable	: Disabled	*Current ChassisFAN Speed	: 0 PRM
Video RAM Cacheable	: Disabled	*Current PWRFAN Speed	: 0 PRM
8 Bit I/O Recovery Time	: 3	*Current CPUFAN Speed	: 0 RPM
16 Bit I/O Recovery Time	: 2	*Vcore : 2.80V	VTT(V) : 1.47V
Memory Hole At 15M-16M	: Disabled	*+3.3V : 3.45V	+5V : 4.91V
Passive Release	: Enabled	*+12V : 12.22V	-12V : -11.76
Delayed Transaction	: Disabled	*-5V : -5.16V	
AGP Aperture Size (MB)	: 128	Esc: Quit	↑↓→←:Select Item
SDRAM RAS-to-CAS Delay	: Slow	F1 : Help	PU/PD/+/-:Modify
SDRAM RAS Precharge Time	: Slow	F5 : Old Values	(Shift)F2 :Color
		F6 :Load BIOS Defaults	
		F7 :Load Setup Defaults	

**5b. Intel Pentium II 266MHz (66 x 4.0)**

ROM PCI/ISA BIOS (ATC-6510)  
 CHIPSET FEATURES SETUP  
 AWARD SOFTWARE, INC.

Auto Configuration	: Enabled	SDRAM CAS latency Time	: 3
DRAM Speed Selection	: 60 ns	CPU Clock Ratio	: 4.0x
MA Wait State	: Slow	Auto Detect DIMM/PCI Clk	: Enabled
EDO RAS# To CAS# Delay	: 3	CPU Clock Frequency	: 66MHz
EDO RAS# Precharge Time	: 3	Spread Spectrum Modulated	: Disabled
EDO DRAM Read Burst	: x333	<b>*Following menus are optional*</b>	
EDO DRAM Write Burst	: x222	*CPU Warning Temperature	: Disabled
CPU-To-PCI IDE Posting	: Disabled	*Current System Temperature	: 20 ° C/ 68 ° F
System BIOS Cacheable	: Disabled	*Current CPU Temperature	: 20 ° C/ 68 ° F
Video BIOS Cacheable	: Disabled	*Current ChassisFAN Speed	: 0 PRM
Video RAM Cacheable	: Disabled	*Current PWRFAN Speed	: 0 PRM
8 Bit I/O Recovery Time	: 3	*Current CPUFAN Speed	: 0 RPM
16 Bit I/O Recovery Time	: 2	*Vcore : 2.80V	VTT(V) : 1.47V
Memory Hole At 15M-16M	: Disabled	*+3.3V : 3.45V	+5V : 4.91V
Passive Release	: Enabled	*+12V : 12.22V	-12V : -11.76
Delayed Transaction	: Disabled	*-5V : -5.16V	
AGP Aperture Size (MB)	: 128	Esc: Quit	↑↓→←:Select Item
SDRAM RAS-to-CAS Delay	: Slow	F1 : Help	PU/PD/+/-:Modify
SDRAM RAS Precharge Time	: Slow	F5 : Old Values	(Shift)F2 :Color
		F6 :Load BIOS Defaults	
		F7 :Load Setup Defaults	

**5c. Intel Pentium II 300MHz (66 x 4.5)**

ROM PCI/ISA BIOS (ATC-6510)  
 CHIPSET FEATURES SETUP  
 AWARD SOFTWARE, INC.

Auto Configuration	: Enabled	SDRAM CAS latency Time	: 3
DRAM Speed Selection	: 60 ns	CPU Clock Ratio	: 4.5x
MA Wait State	: Slow	Auto Detect DIMM/PCI Clk	: Enabled
EDO RAS# To CAS# Delay	: 3	CPU Clock Frequency	: 66MHz
EDO RAS# Precharge Time	: 3	Spread Spectrum Modulated	: Disabled
EDO DRAM Read Burst	: x333	<b>*Following menus are optional*</b>	
EDO DRAM Write Burst	: x222	*CPU Warning Temperature	: Disabled
CPU-To-PCI IDE Posting	: Disabled	*Current System Temperature	: 20 ° C/ 68 ° F
System BIOS Cacheable	: Disabled	*Current CPU Temperature	: 20 ° C/ 68 ° F
Video BIOS Cacheable	: Disabled	*Current ChassisFAN Speed	: 0 PRM
Video RAM Cacheable	: Disabled	*Current PWRFAN Speed	: 0 PRM
8 Bit I/O Recovery Time	: 3	*Current CPUFAN Speed	: 0 RPM
16 Bit I/O Recovery Time	: 2	*Vcore : 2.80V	VTT(V) : 1.47V
Memory Hole At 15M-16M	: Disabled	*+3.3V : 3.45V	+5V : 4.91V
Passive Release	: Enabled	*+12V : 12.22V	-12V : -11.76
Delayed Transaction	: Disabled	*-5V : -5.16V	
AGP Aperture Size (MB)	: 128	Esc: Quit	↑↓→←:Select Item
SDRAM RAS-to-CAS Delay	: Slow	F1 : Help	PU/PD/+/-:Modify
SDRAM RAS Precharge Time	: Slow	F5 : Old Values	(Shift)F2 :Color
		F6 :Load BIOS Defaults	
		F7 :Load Setup Defaults	

## 5d. Intel Pentium II 333MHz (66 x 5.0)

ROM PCI/ISA BIOS (ATC-6510)  
 CHIPSET FEATURES SETUP  
 AWARD SOFTWARE, INC.

Auto Configuration	: Enabled	SDRAM CAS latency Time	: 3
DRAM Speed Selection	: 60 ns	CPU Clock Ratio	: 5.0x
MA Wait State	: Slow	Auto Detect DIMM/PCI Clk	: Enabled
EDO RAS# To CAS# Delay	: 3	CPU Clock Frequency	: 66MHz
EDO RAS# Precharge Time	: 3	Spread Spectrum Modulated	: Disabled
EDO DRAM Read Burst	: x333	<b>*Following menus are optional*</b>	
EDO DRAM Write Burst	: x222	*CPU Warning Temperature	: Disabled
CPU-To-PCI IDE Posting	: Disabled	*Current System Temperature	: 20 ° C/ 68 ° F
System BIOS Cacheable	: Disabled	*Current CPU Temperature	: 20 ° C/ 68 ° F
Video BIOS Cacheable	: Disabled	*Current ChassisFAN Speed	: 0 PRM
Video RAM Cacheable	: Disabled	*Current PWRFAN Speed	: 0 PRM
8 Bit I/O Recovery Time	: 3	*Current CPUFAN Speed	: 0 RPM
16 Bit I/O Recovery Time	: 2	*Vcore : 2.80V	VTT(V) : 1.47V
Memory Hole At 15M-16M	: Disabled	*+3.3V : 3.45V	+5V : 4.91V
Passive Release	: Enabled	*+12V : 12.22V	-12V : -11.76
Delayed Transaction	: Disabled	*-5V : -5.16V	
AGP Aperture Size (MB)	: 128	Esc: Quit	↑↓→←:Select Item
SDRAM RAS-to-CAS Delay	: Slow	F1 : Help	PU/PD/+/-:Modify
SDRAM RAS Precharge Time	: Slow	F5 : Old Values	(Shift)F2 :Color
		F6 :Load BIOS Defaults	
		F7 :Load Setup Defaults	

**5e. Intel Celeron™ CPU 266MHz (66 x 4.0)**

ROM PCI/ISA BIOS (ATC-6510)  
 CHIPSET FEATURES SETUP  
 AWARD SOFTWARE, INC.

Auto Configuration	: Enabled	SDRAM CAS latency Time	: 3
DRAM Speed Selection	: 60 ns	CPU Clock Ratio	: 4.0x
MA Wait State	: Slow	Auto Detect DIMM/PCI Clk	: Enabled
EDO RAS# To CAS# Delay	: 3	CPU Clock Frequency	: 66MHz
EDO RAS# Precharge Time	: 3	Spread Spectrum Modulated	: Disabled
EDO DRAM Read Burst	: x333	<b>*Following menus are optional*</b>	
EDO DRAM Write Burst	: x222	*CPU Warning Temperature	: Disabled
CPU-To-PCI IDE Posting	: Disabled	*Current System Temperature	: 20 ° C/ 68 ° F
System BIOS Cacheable	: Disabled	*Current CPU Temperature	: 20 ° C/ 68 ° F
Video BIOS Cacheable	: Disabled	*Current ChassisFAN Speed	: 0 PRM
Video RAM Cacheable	: Disabled	*Current PWRFAN Speed	: 0 PRM
8 Bit I/O Recovery Time	: 3	*Current CPUFAN Speed	: 0 RPM
16 Bit I/O Recovery Time	: 2	*Vcore : 2.80V	VTT(V) : 1.47V
Memory Hole At 15M-16M	: Disabled	*+3.3V : 3.45V	+5V : 4.91V
Passive Release	: Enabled	*+12V : 12.22V	-12V : -11.76
Delayed Transaction	: Disabled	*-5V : -5.16V	
AGP Aperture Size (MB)	: 128	Esc: Quit	↑↓→←:Select Item
SDRAM RAS-to-CAS Delay	: Slow	F1 : Help	PU/PD/+/-:Modify
SDRAM RAS Precharge Time	: Slow	F5 : Old Values	(Shift)F2 :Color
		F6 :Load BIOS Defaults	
		F7 :Load Setup Defaults	

**5f. Intel Celeron™ CPU 300MHz (66 x 4.5)**



ROM PCI/ISA BIOS (ATC-6510)  
 CHIPSET FEATURES SETUP  
 AWARD SOFTWARE, INC.

Auto Configuration	: Enabled	SDRAM CAS latency Time	: 3
DRAM Speed Selection	: 60 ns	CPU Clock Ratio	: 4.5x
MA Wait State	: Slow	Auto Detect DIMM/PCI Clk	: Enabled
EDO RAS# To CAS# Delay	: 3	CPU Clock Frequency	: 66MHz
EDO RAS# Precharge Time	: 3	Spread Spectrum Modulated	: Disabled
EDO DRAM Read Burst	: x333	<b>*Following menus are optional*</b>	
EDO DRAM Write Burst	: x222	*CPU Warning Temperature	: Disabled
CPU-To-PCI IDE Posting	: Disabled	*Current System Temperature	: 20 °C/ 68 °F
System BIOS Cacheable	: Disabled	*Current CPU Temperature	: 20 °C/ 68 °F
Video BIOS Cacheable	: Disabled	*Current ChassisFAN Speed	: 0 PRM
Video RAM Cacheable	: Disabled	*Current PWRFAN Speed	: 0 PRM
8 Bit I/O Recovery Time	: 3	*Current CPUFAN Speed	: 0 RPM
16 Bit I/O Recovery Time	: 2	*Vcore : 2.80V	VTT(V) : 1.47V
Memory Hole At 15M-16M	: Disabled	*+3.3V : 3.45V	+5V : 4.91V
Passive Release	: Enabled	*+12V : 12.22V	-12V : -11.76
Delayed Transaction	: Disabled	*-5V : -5.16V	
AGP Aperture Size (MB)	: 128	Esc: Quit	↑↓→←:Select Item
SDRAM RAS-to-CAS Delay	: Slow	F1 : Help	PU/PD/+/-:Modify
SDRAM RAS Precharge Time	: Slow	F5 : Old Values	(Shift)F2 :Color
		F6 :Load BIOS Defaults	
		F7 :Load Setup Defaults	

**5g. Intel Celeron™ CPU 333MHz (66 x 5.0)**

ROM PCI/ISA BIOS (ATC-6510)

CHIPSET FEATURES SETUP

AWARD SOFTWARE, INC.

Auto Configuration	: Enabled	SDRAM CAS latency Time	: 3
DRAM Speed Selection	: 60 ns	CPU Clock Ratio	: 5.0x
MA Wait State	: Slow	Auto Detect DIMM/PCI Clk	: Enabled
EDO RAS# To CAS# Delay	: 3	CPU Clock Frequency	: 66MHz
EDO RAS# Precharge Time	: 3	Spread Spectrum Modulated	: Disabled
EDO DRAM Read Burst	: x333	<b>*Following menus are optional*</b>	
EDO DRAM Write Burst	: x222	*CPU Warning Temperature	: Disabled
CPU-To-PCI IDE Posting	: Disabled	*Current System Temperature	: 20 °C/ 68 °F
System BIOS Cacheable	: Disabled	*Current CPU Temperature	: 20 °C/ 68 °F
Video BIOS Cacheable	: Disabled	*Current ChassisFAN Speed	: 0 PRM
Video RAM Cacheable	: Disabled	*Current PWRFAN Speed	: 0 PRM
8 Bit I/O Recovery Time	: 3	*Current CPUFAN Speed	: 0 RPM
16 Bit I/O Recovery Time	: 2	*Vcore : 2.80V	VTT(V) : 1.47V
Memory Hole At 15M-16M	: Disabled	*+3.3V : 3.45V	+5V : 4.91V
Passive Release	: Enabled	*+12V : 12.22V	-12V : -11.76
Delayed Transaction	: Disabled	*-5V : -5.16V	
AGP Aperture Size (MB)	: 128	Esc: Quit	↑↓→←:Select Item
SDRAM RAS-to-CAS Delay	: Slow	F1 : Help	PU/PD/+/-:Modify
SDRAM RAS Precharge Time	: Slow	F5 : Old Values	(Shift)F2 :Color
		F6 :Load BIOS Defaults	
		F7 :Load Setup Defaults	

## 2-3 SYSTEM MEMORY INSTALLATION

The ATC-6510 provides two 168-pin DIMM sockets for system memory expansion from 8MB to 256MB. These two DIMMs are arranged to two banks, please refer to page A. Each bank provides 64-bit wide data path.

**Samples of System Memory Combinations Options**

BANK0 DIMM 1	BANK1 DIMM 2	Total Memory DIMM 1-2
8MBx1	-	8MB
-	8MBx1	8MB
8MBx1	8MBx1	16MB
16MBx1	-	16MB
-	16MBx1	16MB
8MBx1	16MBx1	24MB
16MBx1	8MBx1	24MB
16MBx1	16MBx1	32MB
32MBx1	-	32MB
-	32MBx1	32MB
32MBx1	32MBx1	64MB
32MBx1	64MBx1	96MB
64MBx1	32MBx1	96MB
64MBx1	64MBx1	128MB
:	:	:
128MBx1	128MBx1	256MB



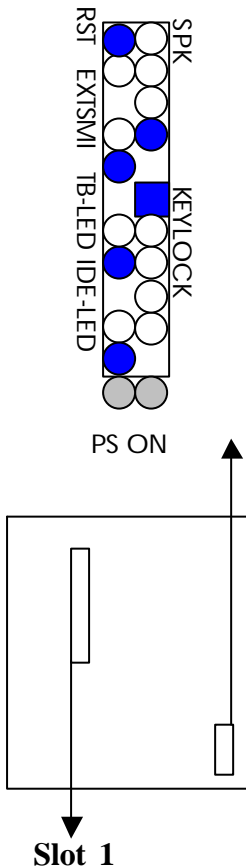

**2-4 CONNECTORS DESCRIPTION**

The locations of following connectors are indicated in page A. When you plug wires into the following connector of CONN1, you should have the pin 1 edge of the wires align with the pin 1 end of the connector.





**CONN1** : speaker, keyboard lock, reset, SMI, turbo LED, and IDE LED connectors.



**SPK : speaker**

-  Speaker
-  GND
-  GND
-  VCC



**Power LED connector**

-  Power LED +
-  N/C
-  GND (power)
-  Keylock
-  GND

**RST : Reset connector**

-  Reset Signal
-  GND

**SMI : SMI lead**

-  GND
-  SMI Signal

**TB-LED : Turbo LED indicator, LED on when system runs higher speed.**

-  GND
-  +5V

**IDE-LED : IDE devices indicator LED connector. IDE-LED stays ON indicates**

LED signal on-board IDE devices in operation

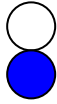

Pin 12 ← PS\_ON : Power Button  
 Pin 24 ← Pin 12 : PS\_ON      Pin 24 : +5VSB

(2) Chassis FAN      (1) CPU FAN

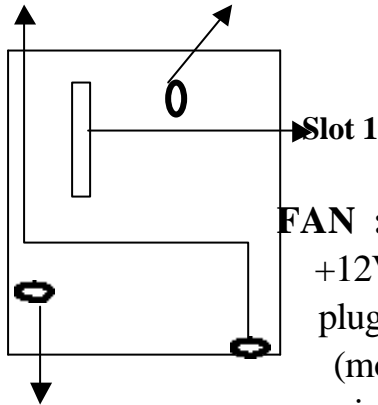

**FAN** : CPU cooling fan connector. Wire with +12V voltage (most likely red wire) must be plugged into pin2, and GROUND wires (most likely black wire) must be plugged into pin3. Please confirm the wire color re-presentation with your supplier.

- 1 □ GND
- 2 ○ +12V
- 3 ○ Sense

**CAUTION:** Plug the wire into wrong connector will DAMAGE fan and mainboard.

**FAN1 for CPU Fan.**  
**FAN2 for Chassis Fan.**  
**FAN3 for Power Fan.**

**IR1** : Infrared module connector.

- 1 □ +5V
- 2 ○ FIRRX
- 3 ○ IRRX
- 4 ○ GND
- 5 ○ IRTX

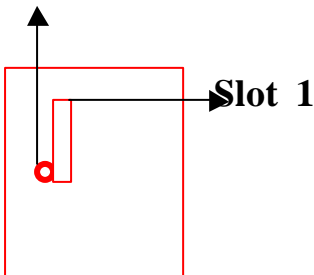

**PW1** : ATX mode +3.3/5/12V power supply

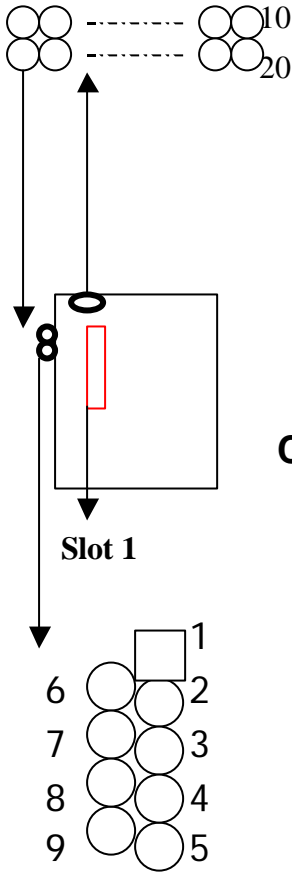

connector.

1	3.3V	6	+5V	11	3.3V	16	GND
2	3.3V	7	GND	12	-12V	17	GND
3	GND	8	PWRGD	13	GND	18	-5V
4	+5V	9	5VSB	14*	PS_ON	19	+5V
5	GND	10	+12V	15	GND	20	+5V

\* PS\_ON : Soft-Off power control

**COM1/COM2** : these two connectors are used to connect serial port cables.

pin	Signal name
1	NDCDA/B
2	NSINA/B
3	NSOUTA/B
4	NDTRA/B
5	GND
6	NDSRA/B
7	NRTSA/B
8	NCTSA/B
9	NRSA/B

A is COM1, B is COM2

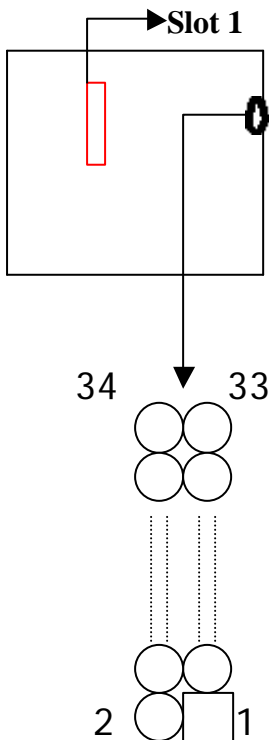

**FDC1** : this connector is used to connect the floppy drive through a cable.

pin	signal	pin	signal
2	RWC-	20	STEP-
4	Reserved	22	Write Data
6	FDEDIN	24	Write Gate
8	Index-	26	Track 00-
10	Motor EnableA-	28	Write Protect-
12	Drive Sele.B-	30	Read Data-
14	Drive Sele.A-	32	Side 1 Sele.-
16	Motor EnableB-	34	DisketteChange
18	DIR-		
All of odd pins are ground			

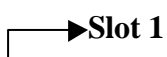

**LPT** : this connector is used to connect parallel

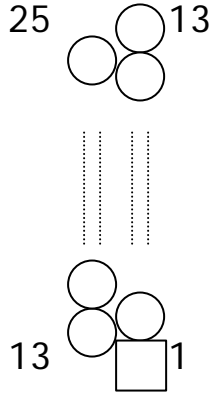
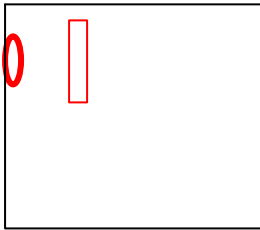

port cable.

Pin	Signal	pin	Signal
1	STROBE-	10	ACK-
2	Data Bit 0	11	BUSY
3	Data Bit 1	12	PE
4	Data Bit 2	13	SLCT
5	Data Bit 3	14	Auto Feed-
6	Data Bit 4	15	ERROR-
	Data Bit 5	16	INIT-
8	Data Bit 6	17	SLCT IN-
9	Data Bit 7		
Pin18 -- pin25 are GND			

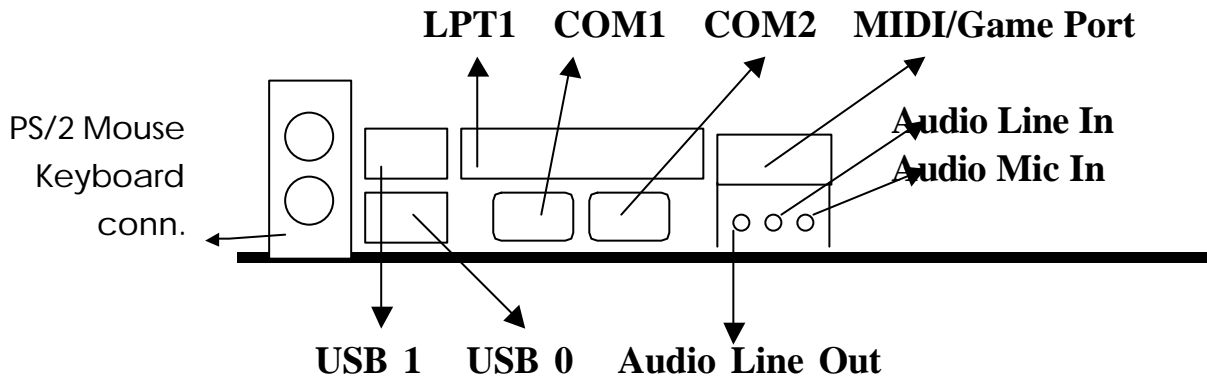

**IDE1/IDE2** : these two connectors are used to

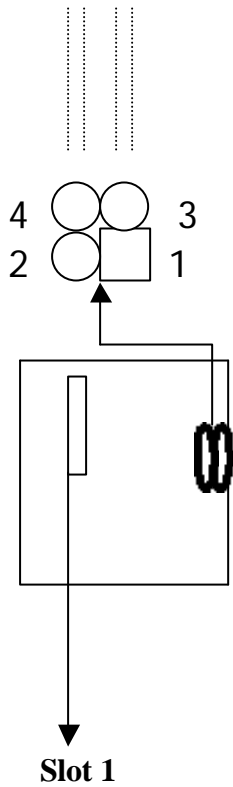
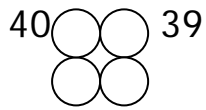

connect IDE devices through IDE cables,  
a total of 4 devices can be connected.

pin	signal	Pin	Signal
1	Reset IDE	21	DDRQ0(1)
2	GND	22	GND
3	Host Data 7	23	I/O Write-
4	Host Data 8	24	GND
5	Host Data 6	25	I/O Read-
6	Host Data 9	26	GND
7	Host Data 5	27	IORDY
8	Host Data 10	28	N/C
9	Host Data 4	29	DDAK0- (1-)
10	Host Data 11	30	GND
11	Host Data 3	31	IRQ14*
12	Host Data 12	32	IOCS16-
13	Host Data 2	33	Addr 1
14	Host Data 13	34	N/C
15	Host Data 1	35	Addr 0
16	Host Data 14	36	Addr 2
17	Host Data 0	37	ChipSele.1P-
18	Host Data 15	38	ChipSele.3P-
19	GND	39	Activity
20	Key	40	GND

\* IDE1 : pin31 is IRQ14;

IDE2 : pin31 is IRQ15 or MIRQ0



## 2-5 IDE DRIVER INSTALLATION

The IDE driver installation procedure is as following :

### Setup for Windows 95 :

1. Starting Windows 95
2. Select “START”, “RUN”.
3. Install INF.EXE before you install IDE driver, please refer to readme file.
4. Type “A:\WIN95\SETUP.EXE”.

**If the installation is to be done from CD-ROM, put the All-In-One CD into your CD-ROM drive; In Windows 95, choose Run menu, type D:\WIN95\SETUP.EXE.(If your CD-ROM is not the drive D, type the appropriate letter instead.)**

5. Restart computer, then follow the instructions on your screen to install new IDE driver we offer in the 3.5“ diskette or CD.
6. Exit Windows 95, turn power off; then turn power on.  
After installation, the screen will show a yellow ! , please ignore it.  
(The other platforms please refer to readme file.)

Make sure your HDD should follow ATA standard, and your CD-ROM should follow ATAPI standard. When you plug-in the IDE devices, please plug your first and second devices into IDE 1 port (Master then Slave), then plug third and forth devices into IDE 2 port. If you have CD-ROM driver, please set it behind hard disk devices as the last device. For example, if you have 2 HDDs and 1 CD-ROM, you should set HDD1 and HDD2 in IDE1 Master and Slave, set CD-ROM in IDE 2 Master. Some of the brands devices combination may not work under this sequence, you can try to re-arrange the devices sequence, or contact your vendor.

Primary Master	Primary Slave	Secondary Master	Secondary Slave	
ATA				no ATAPI
ATA		ATAPI		disk & CD-ROM
ATA	ATAPI			use only one cable
ATA		ATAPI	ATAPI	CD-ROM and a tape or two CD-ROMs

## **2-6 VGA & SOUND DRIVER INSTALLATION**

The All-In-One CD contains “readme.txt”, “Ati AGP Driver”, “Yamaha 715 ISA driver” and “Yamaha 724 PCI driver” four application programs.

# CHAPTER 3 Award BIOS SETUP

Award BIOS manufacturer provides access to the system BIOS through the hardware and software on each ATC-6510 mainboard. The hardware consists of a Flash ROM and the software is a group of programs that are installed in the ROMBIOS along with all the other data the BIOS must contain.

The ATC-6510 mainboard will require special driver supplied by the manufacturer to update the BIOS SETUP program. It is a good idea to read the next page for details for update BIOS driver installation or you can ask your system dealer to do it for you.

When the driver has been successfully updated, it is very important to contact your system dealer to change the CMOS settings for your computer. The CMOS settings are shown in the following pages.

**NOTE :** To clear CMOS you should unplug the power cord, then set 2-3 to clear, put it back to normal position and plug the power cord again.

	JP8
Normal	1-2
Clear	2-3

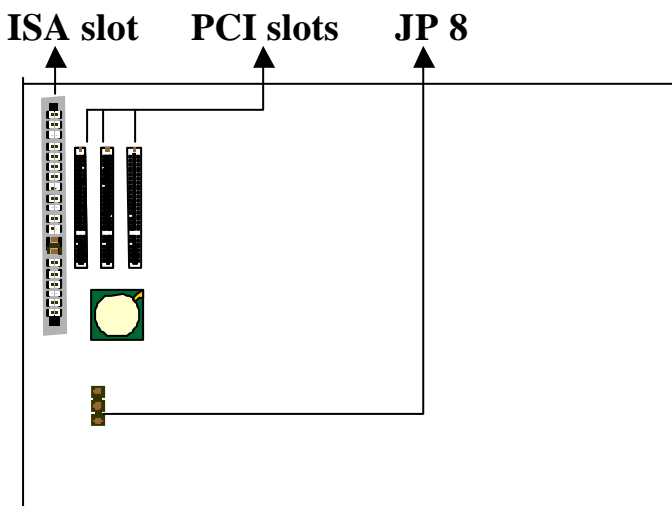
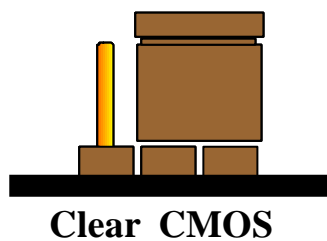
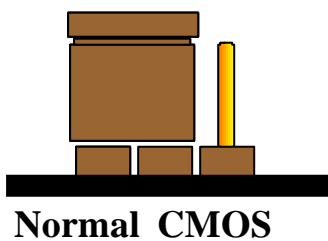

## 3-1 UPDATE BIOS PROCEDURE

If the BIOS needs to be updated, you can get a diskette with the updated BIOS from your system supplier. The BIOS diskette includes :

“awdf flash.exe” -- BIOS update utility program

“awdf flash.doc”

“(update BIOS filename with version number).bin”

The update procedure is as following:

1. Boot the system to DOS mode in a normal manner.
2. Insert the updated diskette to drive A (or B).
3. Change working directory to floppy drive, A or B, which contains the update BIOS diskette. -- Type “a:\” or “b:\”, “ENTER”.
4. Run the BIOS update utility -- Type “awdf flash”, “ENTER”.
5. Type “(update BIOS file name with version number).bin”, ENTER.
6. If you do not want to save the old BIOS Type “N” when the screen displays the message : " Do you want to save BIOS (Y/N) ?".
7. Type “Y“ when the screen shows the message : " Are you sure to program (Y/N) ?".
8. Follow instructions displayed on the screen. DO NOT remove the update BIOS diskette from the floppy drive nor turn the system power off until the BIOS update is completed.
9. Turn the power off. Clear the data in CMOS according to the procedure described in the previous page.
10. Turn the system power on and test that your system is working properly.

### **3-1-1 UPDATE PENTIUM II MICROCODE API**

Intel also provides MICROCODE API (Applications Programming Interface) for Pentium II processor-based mainboard user to update data block in BIOS quickly and easily. (You can find this utility in the All-In-One CD in the mainboard package).

The BIOS code on the Pentium II processor-based mainboards contains data that is specific to each silicon stepping of the processor. Integrators must ensure that this BIOS stepping data matches the processor stepping used. When the BIOS does not contain stepping data that matches the processor stepping, integrators must update the data in the BIOS before shipping the system. Historically, Pentium II systems have been updated by replacing the entire BIOS with a new revision of BIOS that contains the correct stepping data.

Intel's BIOS update API allows just the stepping data within the BIOS to be updated as needed. Mainboards that contain a BIOS with the Intel-defined BIOS update API can be quickly and easily updated, if required, without obtaining a complete BIOS upgrade. Using this utility, integrators can easily verify that the correct stepping data is present in all Pentium II processor-based mainboards. However, if the stepping data requires updating, the mainboard BIOS must contain the Intel-defined BIOS update API, otherwise a complete BIOS upgrade is required from the mainboard vendor.

Put the All-In-One CD into your CD-ROM drive, e.g. drive E, and then type  
E:\>"ENTER", and type \api\checkup3.

The main menu should now be displayed, showing the following four options :

- 1) Check and load update
- 2) Specify stepping data file [current : pep.pdb]
- 3) Help
- 4) Quit without loading update

Select 1 to know the stepping filename, select 2 to load right patch code, then select 1 to update proper patch code. Now, the screen will show the message "please remove floppy diskette from floppy disk drive". Then cold boot (mechanical power off) system to continue. For more information, please refer to "CHECKUP.HLP" file.

## **3-2 Award SYSTEM BIOS**

# CONFIGURATION SETUP

The following pages explain how to set up the system configuration (CMOS) under the Award BIOS. The SETUP program is stored in the Read-Only-Memory (ROM) on the mainboard. To do the SETUP procedure, press the <Del> key when the system is booting up. The following main menu will appear. Please select "STANDARD CMOS SETUP" to enter the next screen.

ROM PCI/ISA BIOS (ATC-6510)  
CMOS SETUP UTILITY  
AWARD SOFTWARE, INC.

STANDARD CMOS SETUP	INTEGRATED PERIPHERALS
BIOS FEATURES SETUP	SUPERVISOR PASSWORD
CHIPSET FEATURES SETUP	USER PASSWORD
POWER MANAGEMENT SETUP	IDE HDD AUTO DETECTION
PNP/PCI CONFIGURATION	SAVE & EXIT SETUP
LOAD BIOS DEFAULTS	EXIT WITHOUT SAVING
LOAD SETUP DEFAULTS	
ESC: Quit	↓→←:Select Item
F10: Save & Exit Setup	(Shift) F2 : Change Color
Time, Date, Hard Disk Type .....	

The section on the bottom of the main menu explains how to control this screen. The other section displays the items highlighted in the list.

**This screen records some basic hardware information, and sets the system clock and error**

handling. These records can be lost or corrupted if the on-board battery has failed or is weak.

ROM PCI/ISA BIOS (ATC-6510)  
 CMOS SETUP UTILITY  
 AWARD SOFTWARE, INC.

STANDARD CMOS SETUP	INTEGRATED PERIPHERALS
BIOS FEATURES SETUP	SUPERVISOR PASSWORD
CHIPSET FEATURES SETUP	USER PASSWORD
POWER MANAGEMENT SETUP	IDE HDD AUTO DETECTION
PNP/PCI CONFIGURATION	SAVE & EXIT SETUP
LOAD BIOS DEFAULTS	EXIT WITHOUT SAVING
LOAD SETUP DEFAULTS	
ESC: Quit	↑↓→←:Select Item
F10: Save & Exit Setup	(Shift) F2 : Change Color
Time, Date, Hard Disk Type .....	

ROM PCI/ISA BIOS (ATC-6510)  
 STANDARD CMOS SETUP  
 AWARD SOFTWARE, INC.

Date (mm:dd:yy) : Wed, May 20 1998									
Time(hh:mm:ss) : 13 : 37 : 14									
HARD DISKS	TYPE	SIZE	CYLS	HEAD	PRECOMP	LANDZ	SECTOR	MODE	
Primary Master	: Auto	0	0	0	0	0	0	Auto	
Primary Slave	: Auto	0	0	0	0	0	0	Auto	
Secondary Master	: Auto	0	0	0	0	0	0	Auto	
Secondary Slave	: Auto	0	0	0	0	0	0	Auto	
Drive A : 1.44M, 3.5 in.									
Drive B : None									
Floppy 3 Mode Support : Disabled									
Video : EGA/VGA									
Halt On: All Errors									
					Base Memory	:	640K		
					Extended memory	:	7168K		
					Other Memory	:	384K		
					-----				
					Total Memory	:	8192K		
ESC	:	Quit	↑↓→←:Select Item			PU/PD/+/- : Modify			
F1	:	Help	(Shift) F2 : Change Color						

Date

The date format is <day>, <date><month><year>.

Press<F3> to show the calendar.

Day	The day, from Sun to Sat, determined by the BIOS and is display-only
Date	The date, from 1 to 31
Month	The month, Jan. through Dec.
Year	The year, from 1900 to 2099

**Time**

The time format is <hour><minute><second>. The time is calculated based on the 24-hour military-time clock. For example, 1p.m. is 13:00:00.

**Primary Master**  
**Primary Slave**  
**Secondary Master**  
**Secondary Slave**

These categories identify the types of the 2 channels that have been installed in the computer. There are 45 predefined types and 4 user definable types are for Enhanced IDE BIOS. Type 1 to 45 are predefined. Type **'user'** is user-definable. Press PgUp/PgDn to select a numbered hard disk type or type the number and press<Enter>. If you select **'Auto'**, the BIOS will auto-detect the HDD & CD-ROM Drive at the POST stage and show the IDE for HDD & CD-ROM Drive. If you select **'user'**, you will need to know the information listed below. Enter the information directly from the keyboard and press <Enter>. This information should be from your hard disk vender or dealer. If the controller of the HDD interface is ESDI, the selection shall be **'Type 1'**; if SCSI, the selection shall be **'None'**. If no device is installed select **'NONE'** and press <Enter>.

Type	drive type
SIZE	Automatically adjusts
CYLS	number of cylinders
HEAD	number of heads
PRECOMP	write precom
LANDZ	landing zone
SECTOR	number of sectors
MODE	mode type

**Drive A**

This category identifies the types of floppy disk drive



### Drive B

A or drive B that have been installed in the computer.

None	No floppy drive installed
360K, 5.25 in	5.25" PC-type 360KB capacity
1.2M, 5.25 in	5.25" AT-type 1.2MB capacity
720K, 3.5 in	3.5" double-side 720KB capacity
1.44M, 3.5 in	3.5" double-side 1.44MB capacity
2.88M, 3.5 in	3.5" double-side 2.88MB capacity

### Floppy 3 Mode Support

This is the Japanese standard floppy drive. This standard stores 1.2MB in a 3.5" diskette

### Video

This category selects the type of video adapter used for the primary system monitor. Although secondary monitors are supported, you do not have to select the type in Setup.

EGA/VGA	Enhanced Graphics Adapter/Video Graphics Array. For EGA, VGA, SEGA, SVGA or VGA monitor adapters
CGA 40	Color Graphics Adapters, power up in 40 column mode
CGA 80	Color Graphics Adapters, power up in 80 column mode
MONO	Monochrome adapter, includes high resolution monochrome adapters

### Halt On

This category determines whether the computer will stop if an error is detected during power up.

No errors	The system boot will not be stopped for any error that may be detected
All errors	When the BIOS detects a non-fatal error the system will be stopped and you will be prompted
All, But Keyboard	The system boot will not stop for a keyboard error, it will stop for all other errors
All, But Diskette	The system boot will not stop for a disk error, it will stop for all other errors
All, But Disk/Key	The system boot will not stop for a disk or keyboard error, it will stop for all other errors

### Memory

This category is display-only which is determined by POST

(Power On Self Test) of the BIOS.

**Base Memory** The POST will determine the amount of base (or conventional) memory installed in the system. The value of the base memory is typically 512K or 640K based on the memory installed on the motherboard.

**Extended Memory** How much extended memory is present during the POST. This is the amount of memory located above 1MB in the CPU's memory address map.

**Other Memory** This refers to the memory located in the 640K to 1024K address space. This is memory that can be used for different applications. DOS users this area to load device drivers in an effort to keep as much base memory free for application programs. The BIOS is the most frequent user of this RAM area since this is where it shadows RAM.

**This screen is a list of system configuration options. Some of them are defaults required by the**

mainboard's design, others depend on the features of your system.

ROM PCI/ISA BIOS (ATC-6510)

CMOS SETUP UTILITY

AWARD SOFTWARE, INC.

STANDARD CMOS SETUP	INTEGRATED PERIPHERALS
BIOS FEATURES SETUP	SUPERVISOR PASSWORD
CHIPSET FEATURES SETUP	USER PASSWORD
POWER MANAGEMENT SETUP	IDE HDD AUTO DETECTION
PNP/PCI CONFIGURATION	SAVE & EXIT SETUP
LOAD BIOS DEFAULTS	EXIT WITHOUT SAVING
LOAD SETUP DEFAULTS	
ESC: Quit	↑↓→←:Select Item
F10: Save & Exit Setup	(Shift) F2 : Change Color
Virus, Protection, Boot Sequence	

ROM PCI/ISA BIOS (ATC-6510)

BIOS FEATURES SETUP

AWARD SOFTWARE, INC.

Virus Warning	: Disabled	Video BIOS Shadow	: Enabled
CPU Internal Cache	: Enabled	C8000-CBFFF Shadow	: Disabled
External Cache	: Enabled	CC000-CFFFF Shadow	: Disabled
Quick Power On Self Test	: Enabled	D0000-D3FFF Shadow	: Disabled
Boot Sequence	: A,C,SCSI	D4000-D7FFF Shadow	: Disabled
Swap Floppy Drive	: Disabled	D8000-DBFFF Shadow	: Disabled
Boot Up Floppy Seek	: Enabled	DC000-DFFFF Shadow	: Disabled
Boot Up NumLock Status	: On		
Boot Up System Speed	: High		
Gate A20 Option	: Fast		
Typematic Rate Setting	: Disabled		
Typematic Rate(Chars/Sec)	: 6	Esc : Quit	↑↓→←:Select Item
Typematic Delay(Msec)	: 250	F1 : Help	PU/PD/+/- : Modify
Security Option	: Setup	F5 : Old Values (SHIFT)	F2 : Color
PCI/VGA Palette Snoop	: Disabled	F6 : Load BIOS Defaults	
Assign IRQ For VGA	: Enabled	F7 : Load Setup Defaults	
OS Select for DRAM>64MB	: Non-OS2		
Report No FDD For Win95	: No		

**Virus Warning**

When this item is enabled, the Award BIOS will monitor the

boot sector and partition table of the hard disk drive for any attempt at modification. If an attempt is made, the BIOS will halt the system and the following error message will appear. Afterwards, if necessary, you will be able to run an antivirus program to locate and remove the problem before any damage is done.

**! WARNING !**

Disk boot sector is to be modified  
 Type 'Y' to accept write or 'N' to abort write  
 Award Software, Inc.

Enabled	Activates automatically when the system boots up, if anything attempts to access the boot sector or hard disk partition table will cause a warning message to appear.
Disabled	No warning message will appear when anything attempts to access the boot sector or hard disk partition table.

Many disk diagnostic programs which attempt to access the boot sector table can cause the above warning message. If you will be running such a program, we recommend that you first disable Virus Protection beforehand.

**CPU**  
**Internal Cache**  
**External Cache**

These two categories speed up memory access. However, it depends on CPU/chipset design. The default value is 'enabled'.

**Quick Power On Self Test**

This category speeds up Power On Self Test after you power up the computer. If you set Enabled, BIOS will shorten or skip some checked items during POST.

**Boot Sequence**

This category determines which drive is to search

first for the Disk Operating System (i.e., DOS).

A, C, SCSI	System will first search for floppy disk drive then hard disk drive, and the next is SCSI device.
C, A, SCSI	System will first search for hard disk drive then floppy disk drive, and the next is SCSI device.
C, CDROM, A	System will first search for hard disk drive then CDROM drive, and the next is floppy disk drive.
CDROM, C, A	System will first search for CDROM drive then hard disk drive, and the next is floppy disk drive.
D, A, SCSI	System will first search for secondary hard disk drive then floppy disk drive, and the next is SCSI device.
E, A, SCSI	System will first search for third hard disk drive then floppy disk drive, and the next is SCSI device.
F, A, SCSI	System will first search for fourth hard disk drive then floppy disk drive, and the next is SCSI device.
SCSI, A, C	System will first search for SCSI device then floppy disk drive, and the next is hard disk drive.
SCSI, C, A	System will first search for SCSI device then hard disk drive, and the next is floppy disk drive.
C only	System will search for hard disk drive only.
LS/ZIP, C	System will first search for LS120 or IOMEGA (ZIP) drive, and the next is hard disk drive.

C is primary master; D is primary slave;  
E is secondary master, F is secondary slave

**Swap Floppy Drive**

This item allows you to determine whether to enable the swap floppy drive or not.  
The choice : Enabled/ Disabled

**Boot Up Floppy Seek**

During POST, the BIOS will determine if the floppy disk drive installed is 40 tracks (360K) or 80 tracks (720K, 1.2M, 1.44M)

Enabled	BIOS searches for floppy disk drive to determine if it is 40 or 80 tracks
Disabled	BIOS will not search for the type of floppy disk drive by track number

**Boot Up**

This allows you to determine the default state of

**NumLock Status**

the numeric keypad. By default, the system boots up with NumLock on.

On	Keypad is numeric keys
Off	Keypad is arrow keys

**Boot Up System Speed**

Selects the default system speed - the normal operating speed at power up.

High	Set the speed to high
Low	Set the speed to low

**Gate A20 Option**

This entry allows you to select how the gate A20 is handled. The gate A20 is a device used to address memory above 1 MB. Initially, the gate A20 was handled via a pin on the keyboard. Today, while keyboards still provide this support, it is more common, and much faster, for the system chipset to provide support for gate A20. Normal is keyboard; Fast is chipset.

**Typematic Rate Setting**

This determines if the typematic rate is to be used. When disabled, continually holding down a key on your keyboard will generate only one key instance. In other words, the BIOS will only report that the key is down. When the typematic rate is enabled, the BIOS will report as before, but it will then wait a moment, and, if the key is still down, it will begin the report that the key has been depressed repeatedly. For example, you would use such a feature to accelerate cursor movements with the arrow keys. The choice : Enabled/Disabled

**Typematic Rate (Chars/Sec)**

When the typematic rate is enabled, this section allows you select the rate at which the keys are repeated.

6	6 characters per second
8	8 characters per second
10	10 characters per second
12	12 characters per second
15	15 characters per second
20	20 characters per second
24	24 characters per second
30	30 characters per second

**Typematic Delay**

When the typematic rate is enabled, this section

**(Msec)**

allows you select the delay between when the key was first depressed and when the acceleration begins.

250	250 msec
500	500 msec
750	750 msec
1000	1000 msec

**Security Option**

This category allows you to limit access to the system and Setup, or just to Setup.

System	The system will not boot and access to Setup will be denied if the correct password is not entered at the prompt
Setup	The system will boot, but access to Setup will be denied if the correct password is not entered at the prompt

To disable security, select PASSWORD SETTING at Main Menu and then you will be asked to enter password. Do not type anything and just press <Enter>, it will disable security. Once the security is disabled, the system will boot and you can enter Setup freely.

**PCI/VGA  
Palette Snoop**

It determines whether the MPEG ISA/VESA VGA cards can work with PCI/VGA or not.

Enabled	When PCI/VGA working with MPEG ISA/VESA VGA Card
Disabled	When PCI/VGA not working with MPEG ISA/VESA VGA Card

**Assign IRQ for  
VGA**

When this items is enabled, the system will assign an IRQ for VGA. If this item is disabled, the VGA will not occupy an IRQ; therefore the IRQ of VGA will be released for other usage.

**OS Select for**

This item allows you to access the memory that is over

**DRAM > 64MB**

64MB in OS/2.

The choice : Non-OS2 or OS2

**Report No FDD  
For WIN 95**

Set this item to Yes BIOS will report FDD to Win95.

If in standard CMOS setup, set Drive A to none, and set this item to yes. Inside Win95, My Computer and File manager Disk(A:) will show Removable Disk (A:).

**Video BIOS  
Shadow**

Determines whether video BIOS will be copied to RAM.

However it is optional depending on chipset design.

Video Shadow will increase the video speed.

The choice : Enabled/Disabled

**C8000 - CBFFF  
Shadow**

These categories determine whether option ROMs will be copied to RAM. An example of such option ROM

**DC000 - DFFFF**

would be the support of onboard SCSI.

**Shadow**

The choice : Enabled/Disabled

**Notice that the ATC-6510 mainboard is subdivided into two models. The first model of the ATC-6510 mainboard built-in Hardware Health Monitoring ie Winbond 83781. The second model of the ATC-6510 mainboard did not built-in Hardware Health Monitoring.**

**\*See next page for further information with Hardware Health Monitoring and without Hardware Health Monitoring.\***

**This screen controls the setting for the chipset on the mainboard.**



ROM PCI/ISA BIOS (ATC-6510)  
CMOS SETUP UTILITY  
AWARD SOFTWARE, INC.

STANDARD CMOS SETUP	INTEGRATED PERIPHERALS
BIOS FEATURES SETUP	SUPERVISOR PASSWORD
CHIPSET FEATURES SETUP	USER PASSWORD
POWER MANAGEMENT SETUP	IDE HDD AUTO DETECTION
PNP/PCI CONFIGURATION	SAVE & EXIT SETUP
LOAD BIOS DEFAULTS	EXIT WITHOUT SAVING
LOAD SETUP DEFAULTS	
ESC: Quit	↑↓→←:Select Item
F10: Save & Exit Setup	(Shift) F2 : Change Color
AT Clock, DRAM Timings, .....	

ROM PCI/ISA BIOS (ATC-6510)  
CHIPSET FEATURES SETUP  
AWARD SOFTWARE, INC.

Auto Configuration	: Enabled	SDRAM CAS latency Time	: 3
DRAM Speed Selection	: 60 ns	CPU Clock Ratio	: 3.0x
MA Wait State	: Slow	Auto Detect DIMM/PCI CLK	: Enabled
EDO RAS# To CAS# Delay	: 3	CPU Clock Frequency	: 66MHz
EDO RAS# Precharge Time	: 3	Spread Spectrum Modulated	: Disabled
EDO DRAM Read Burst	: x333	<b>*Following menus are optional*</b>	
EDO DRAM Write Burst	: x222	*CPU Warning Temperature	: Disabled
CPU-to-PCI IDE Posting	: Disabled	*Current System Temperature	: 20 ° C/ 68 ° F
System BIOS Cacheable	: Disabled	*Current CPU Temperature	: 20 ° C/ 68 ° F
Video BIOS Cacheable	: Disabled	*Current CPUFAN Speed	: 0 PRM
Video RAM Cacheable	: Disabled	*Current ChassisFAN Speed	: 0 PRM
8-bit I/O Recovery Time	: 3	*Current PWRFAN Speed	: 0 PRM
16-bit I/O Recovery Time	: 2	*Vcore : 2.80V	VTT(V) : 1.47V
Memory Hole At 15M-16M	: Disabled	*+3.3V : 3.45V	+5V : 4.91V
Passive Release	: Enabled	*+12V : 12.22V	-12V : -11.76
Delayed Transaction	: Disabled	*-5V : -5.16V	
AGP Aperture Size (MB)	: 128	Esc: Quit	:Select Item
SDRAM RAS-to-CAS Delay	: Slow	F1 : Help	PU/PD/+/-:Modify
SDRAM RAS Precharge Time	: Slow	F5 : Old Values	(Shift)F2 :Color
		F6 :Load BIOS Defaults	
		F7 : Load Setup Defaults	

Auto The first chipset settings deal with CPU access to dynamic

## Configuration

random access memory (DRAM). The default timings have been carefully chosen and should only be altered if data is being lost. Such a scenario might well occur if your system had mixed speed DRAM chips installed so that greater delays may be required to preserve the integrity of the data held in the slower memory chips.

### DRAM Speed Selection

The DRAM speed is controlled by the DRAM timing Registers. The timings programmed into this register are dependent on the system design. Slower rates may be required in certain system designs to support loose layouts or slower memory.  
i.e. 60ns; 70ns

### MA Wait State

This item allows you to select MA Wait State.  
The choice : Fast, Slow

### EDO RAS# to CAS# Delay

This sets the relative delay between the row and column address strobes from DRAM (EDO). The choice : 2, 3

### EDO RAS# Precharge Time

Defines the length of time for Row Address Strobe from DRAM (EDO) is allowed to precharge.  
The choice : 3,4

### EDO DRAM Read Burst EDO DRAM Write Burst

This sets the timing for burst mode read (or writes)from DRAM (EDO). Burst read and write requests are generated by the CPU in four separate parts. The lower the timing numbers, the faster the system will address memory.  
i.e. x222 is read/write DRAM timings are 2-2-2-2

### DRAM Data Integrity Mode

Select parity, ECC, or Disabled, depending on the type of DRAM installed in your system.  
The choice : ECC, Parity, Disabled

### CPU-To-PCI IDE posting

Select Enabled to post write cycles from the CPU to the PCI IDE interface. IDE access are posted in the CPU to PCI buffers, for cycle optimization.  
The choice : Enabled, disabled

### System BIOS

Select Enabled allows caching of the system BIOS ROM at

**Cacheable**

F0000h-FFFFFFh, resulting in better system performance. However, if any program writes to this memory area, a system error may result.

**Video BIOS**  
**Cacheable**

Select Enabled allows caching of the video BIOS ROM at F0000h-FFFFFFh, resulting in better system performance. However, if any program writes to this memory area, a system error may result.

**Video RAM**  
**Cacheable**

Select Enabled allows caching of the video RAM, resulting in better system performance. However, if any program writes to this memory area, a system error may result.

**8 Bit I/O**  
**Recovery Time**

The recovery time is the length of time, measured in CPU clocks, which the system will be delay after the completion of an I/O request. This delay takes place because the CPU is operating so much faster than the input/output bus that the CPU must be delayed to allow for the completion of the I/O. This item allows you to determine the recovery time allowed for 8-bit I/O. Choices are from NA, 1 to 8 CPU clocks.

**16 Bit I/O**  
**Recovery Time**

This item allows you to determine the recovery time allowed for 16-bit I/O. Choices are from NA, 1 to 4 CPU clocks.

**Memory Hole At**  
**15M-16M**

In order to improve performance, certain space in memory can be reserved for ISA cards. This memory must be mapped into the memory below 16MB.

**Passive Release**

When Enabled, CPU to PCI bus accesses are allowed during passive release. Otherwise, the arbiter only accepts another PCI master access to local DRAM.  
The choice : Enabled, disabled

**Delayed**  
**Transaction**

This chipset has an embedded 32-bit posted write buffer to support delay transactions cycles. Select Enabled to support compliance with PCI specification version 2.1.  
The choice : Enabled, disabled space

**AGP Aperture**

Select the size of the AGP aperture. The aperture is a portion of

- Size (MB)** the PCI memory address range dedicated for graphics memory address space. Host cycle that hit the aperture range are forwarded to the AGP without any translation. See [www.agpforum.org](http://www.agpforum.org) for AGP information. The choice 4, 8, 16, 32, 64, 128, 256
- SDRAM RAS-to-CAS Delay** You can select RAS to CAS Delay time (CAS latency time) in HCLKs of 2/2 or 3/3. The system board designer should set the values in this field, depending on the DRAM installed. Do not change the values in this field unless you change specifications of the installed DRAM or the installed CPU. The choice: 2,3
- SDRAM CAS latency Time**
- SDRAM RAS Precharge Time** Defines the length of time for Row Address Strobe is allowed to precharge.
- CPU Clock Ratio** Use this option to set CPU clock ratio. After change the CPU Clock Ratio, if the system can not start , please see “ CPU Clock Frequency “ item to solve the problem.
- Auto Detect DIMM/PCI CLK** If this item is enabled, the unused DIMM and PCI slot clock will be disabled. If this item is disabled the unused DIMM and PCI slot will still get the active clock signal.
- Spread Spectrum Modulated** Enable / Disable this item the BIOS will Enable / Disable the clock generator spread spectrum .
- CPU Clock Frequency** Use this item to set CPU base clock frequency.  
**After change the CPU Clock Frequency, if the system can not start, then turn power off, press and hold “ Insert ” key, power on until screen show up.**

**NOTE Press “ Del ” to enter BIOS setup and set the CPU clock**

**frequency / CPU clock ratio to correct value.**

The following functions are optional, and they show only when the monitoring IC exists on the mainboard. Please confirm this with your supplier.

**CPU Warning Temperature**      When this item is enabled, we can set the CPU warning temperature . If the CPU temperature is higher than the setting temperature, the system will beep.

**Current System Temperature**      This field displays the *current* system temperature, if your computer contains a monitoring system.

**Current CPU Temperature**      It shows the current system temperature.

**Current CPUFAN /ChassisFAN/ PWRFAN Speed**      It shows the running speed of the system fan, Chassis fan and power fan. The value will be changing when the system is running. If you do not install the fan, the value will show 0.

**This screen controls the 'green' features of this mainboard.**

ROM PCI/ISA BIOS (ATC-6510)  
 CMOS SETUP UTILITY  
 AWARD SOFTWARE, INC.

STANDARD CMOS SETUP	INTEGRATED PERIPHERALS
BIOS FEATURES SETUP	SUPERVISOR PASSWORD
CHIPSET FEATURES SETUP	USER PASSWORD
POWER MANAGEMENT SETUP	IDE HDD AUTO DETECTION
PNP/PCI CONFIGURATION	SAVE & EXIT SETUP
LOAD BIOS DEFAULTS	EXIT WITHOUT SAVING
LOAD SETUP DEFAULTS	
ESC: Quit	↑↓→← :Select Item
F10: Save & Exit Setup	(Shift) F2 : Change Color
Sleep Timer, Suspend Timer, .....	

ROM PCI/ISA BIOS (ATC-6510)  
 POWER MANAGEMENT SETUP  
 AWARD SOFTWARE, INC.

Power Management : User Defined	*Reload Global Timer Events*
PM Control by APM : Yes	IRQ [3-7, 9-15], NMI :Disabled
Video Off Method : DPMS	Primary IDE 0 :Disabled
Video Off After : Standby	Primary IDE 1 :Disabled
Modem Use IRQ : 3	Secondary IDE 0 :Disabled
Doze Mode : Disabled	Secondary IDE 1 :Disabled
Standby Mode : Disabled	Floppy Disk :Disabled
Suspend Mode : Disabled	Serial Port :Enabled
HDD Power Down : Disabled	Parallel Port :Disabled
Throttle Duty Cycle : 62.5%	
ZZ Active in Suspend : Disabled	
VGA Active Monitor : Enabled	
Soft-Off by PWR-BTTN : Instant-Off	
CPUFAN Off In Suspend : Enabled	
Resume by Ring : Disabled	Esc: Quit    ↑↓→← :Select Item
Resume by Alarm : Disabled	F1 : Help    PU/PD/+/- : Modify
Wake Up On LAN : Enabled	F5 : Old Values    (Shift) F2: Color
IRQ 8 Break Suspend : Disabled	F6 : Load BIOS Defaults
	F7 : Load Setup Defaults

**Power**

This category allows you to select the type (or

Management

degree) of power saving and is directly related to the following modes : **Doze; Standby; Suspend; HDD Power Down.**

Min. Power Saving	Minimum power management. Doze =1hr.; Standby=1hr.; Suspend=1hr.; HDD Power Down=15min
Max. Power Saving	Maximum power management <b>only available for SL CPU.</b> Doze=1 min.; Standby=1 min.;Suspend=1 min.;HDD Power Down=1min
User Defined	Allows you to set each mode individually. When not disabled, each of the ranges are from 1min. to 1hr. except for HDD Power Down which ranges from 1 to 15min. and disable

**If you would like to use Software Power-off Control function, you cannot choose“ Disabled ”here, and should select “Yes” in PM Control by APM.**

PM Control by APM

When enabled, an Advanced Power Management device will be activated to enhance the Max. Power Saving Mode and stop the CPU internal clock. If the Max. Power Saving is not enabled, this will be shown as NO.

Video Off Method

This determines the manner in which the monitor is blanked.

V/H SYNC + Blank	This selection will cause the system to turn off the vertical and horizontal sync. ports and write blanks to the video buffer
Blank Screen	This option only writes blanks to the video buffer
DPMS	Initial display power management signaling

Video off After

When enabled, this feature allows the VGA adapter to

operate in a power saving mode.

N/A	Monitor will remain on during power saving modes.
Suspend	Monitor blanked when the systems enters the Suspend mode.
Standby	Monitor blanked when the system enters Standby mode.
Doze	Monitor blanked when the system enters any power saving mode.

**MODEM Use IRQ** This item determines the IRQ in which the MODEM can be used.

The choice : 3,4,5,7,9,10,11,NA.

*The Following 4 modes are Green PC power saving functions which are only user configurable when 'User Defined' power management has been selected.*

**Doze Mode** When enabled and after the set time of system inactivity, the CPU clock will run at slower speed while all other devices still operate at full speed.

**Standby Mode** When enabled and after the set time of system inactivity, the fixed disk drive and the video would be shut off while all other devices still operate at full speed.

**Suspend Mode** When enabled and after the set time of system inactivity, all devices except the CPU will be shut off.

**HDD Power Down** When enabled and after the set time of system inactivity, the hard disk drive will be powered down while all other devices remain active.

**Throttle Duty Cycle** When the system enters Doze mode, the CPU clock runs only part of time. You may select the percent of time that the clock runs.

**ZZ Active in Suspend** When enabled, the ZZ signal is active during Suspend mode.

**VGA Active Monitor** When Enabled, any video active restarts the global timer for standby mode.

**Soft-Off by** Instant-off : When push the power button, the system power will



**PWR-BTTN**

be off immediately. Delay 4 sec : when push the power button, it will enter suspend mode. We need to push the power button and hold for 4 seconds to turn off the power.

**CPUFAN Off**  
**In Suspend**

Enabled : under suspend mode, the CPU FAN will be turn off.  
Disabled : suspend mode will not turn off CPU FAN.

**Resume by Ring**

Enabled : when system in suspend mode, it can be wake up by modem. Disabled : it cannot be wake up by modem.

**Resume by Alarm**

When Enabled, two additional lines will be added to the screen :  
Date (of Month) Alarm; Time (hh:mm:ss) Alarm to let user set the desired date and time. After power off, the system will automatic power on at the specified date and time.

**Wake Up On LAN**

Enabled : If you have installed LDCM administrator software, and any client side is powered off, you can wake up by LAN through the LDCM mechanism.  
Disabled : You cannot wake up by LAN.

**IRQ 8 Break**  
**Suspend**

When enabled, the device which occupies the IRQ8 can wake up the system.

**This screen configures the PCI Bus slots.**

ROM PCI/ISA BIOS (ATC-6510)  
 CMOS SETUP UTILITY  
 AWARD SOFTWARE, INC.

STANDARD CMOS SETUP	INTEGRATED PERIPHERALS
BIOS FEATURES SETUP	SUPERVISOR PASSWORD
CHIPSET FEATURES SETUP	USER PASSWORD
POWER MANAGEMENT SETUP	IDE HDD AUTO DETECTION
<b>PNP/PCI CONFIGURATION</b>	SAVE & EXIT SETUP
LOAD BIOS DEFAULTS	EXIT WITHOUT SAVING
LOAD SETUP DEFAULTS	
ESC: Quit	↑↓→←:Select Item
F10: Save & Exit Setup	(Shift) F2 : Change Color
IRQ Settings, Latency Timers, .....	

ROM PCI/ISA BIOS (ATC-6510)  
 PNP/PCI CONFIGURATION  
 AWARD SOFTWARE, INC.

PNP OS Installed	: No	PCI IDE IRQ Map to	: PCI-AUTO
Resources Controlled by	: Auto	Primary IDE INT#	: A
Reset Configuration Data	: Disabled	Secondary IDE INT#	: B
		Esc: Quit    ↑↓→← :Select Item	
		F1 : Help        PU/PD/+/- : Modify	
		F5 : Old Values    (Shift) F2: Color	
		F6 : Load BIOS Defaults	
		F7 : Load Setup Defaults	

**PNP OS Installed**

This item allows you to determine PnP OS or not.  
Choices are Yes or No.

**Resource  
Controlled by**

The Award Plug and Play BIOS has the capability to automatically configure all of the boot and Plug and Play compatible devices. However, this capability means absolutely nothing unless you are using a Plug and Play OS such as Windows 95. Choices are Auto and Manual.

**Reset Config-  
uration Data**

This item allows you to determine whether to reset the configuration data or not.

**IRQ3/4/5/7/9/10  
11/12/14/15,  
DMA0/1/3/5/6/7  
Assign to**

This item allows you to determine the IRQ/DMA assigned to the ISA bus and is not available to any PCI slot.  
Choices are Legacy ISA and PCI/ISA PnP.

**PCI IDE IRQ  
Map To  
Primary IDE INT#  
Secondary IDE  
INT#**

This allows you to configure your system to the type of IDE disk controller in use. By default, Setup assumes that your controller is an ISA device rather than a PCI controller. The most apparent difference is the type of slot being used. If you have equipped your system with a PCI controller, changing this allows you to specify which slot holds the controller and which PCI interrupt (A,B,C,D) is associated with the connected hard disk. This setting refers to the hard disk drive itself, rather than individual partitions. Since each IDE controller supports two separate hard drives, you can select the INT# for each. Again, you will note that the primary has a lower interrupt than the secondary as described in “*lot x Using INT#*” above. Select ‘PCI Auto’ allows the system to automatically determine how your IDE disk system is configured.

**Used MEM base  
addr**

This item allows you to determine which basic address will not be occupied by PCI card and leave these address for some special ISA card used only.  
Choices are C800, CC00, D000, D400, D800, DC00.

**Used MEM Length**

This item determines the memory length of address which is for some special ISA Card used. Choices are 8K, 64K, 32K, 16K.

**This section page includes all the items of IDE hard drive and Programmed Input/Output features. See also Section “Chipset Features Setup”.**

ROM PCI/ISA BIOS (ATC-6510)  
 CMOS SETUP UTILITY  
 AWARD SOFTWARE, INC.

STANDARD CMOS SETUP	INTEGRATED PERIPHERALS
BIOS FEATURES SETUP	SUPERVISOR PASSWORD
CHIPSET FEATURES SETUP	USER PASSWORD
POWER MANAGEMENT SETUP	IDE HDD AUTO DETECTION
PNP/PCI CONFIGURATION	SAVE & EXIT SETUP
LOAD BIOS DEFAULTS	EXIT WITHOUT SAVING
LOAD SETUP DEFAULTS	
ESC: Quit	↑↓→←:Select Item
F10: Save & Exit Setup	(Shift) F2 : Change Color
Time, Date, Hard Disk Type .....	

ROM PCI/ISA BIOS (ATC-6510)  
 INTEGRATED PERIPHERALS  
 AWARD SOFTWARE, INC.

IDE HDD Block Mode : Enabled	Onboard Parallel Port : 378/IRQ7
IDE Primary Master PIO : Auto	Onboard Parallel Mode : ECP
IDE Primary Slave PIO : Auto	ECP Mode Use DMA : 3
IDE Secondary Master PIO : Auto	
IDE Secondary Slave PIO : Auto	
IDE Primary Master UDMA : Auto	
IDE Primary Slave UDMA : Auto	
IDE Secondary Master UDMA : Auto	
IDE Secondary Slave UDMA : Auto	
On-Chip Primary PCI IDE : Enabled	
On-Chip Secondary PCI IDE : Enabled	
Onboard Audio Chip : Enabled	
USB Keyboard Support : Disabled	
Init AGP Display First : Disabled	Esc: Quit ↑↓→← :Select Item
Power On Function : Button Only	F1 : Help PU/PD/+/- : Modify
KBC input clock : 8 MHz	F5 : Old Values (Shift) F2: Color
Onboard FDC Controller : Enabled	F6 : Load BIOS Defaults
Onboard Serial Port 1 : 3F8/IRQ4	F7 : Load Setup Defaults
Onboard Serial Port 2 : 3F8/IRQ3	
UART Mode Select : Normal	

**IDE HDD Block Mode**

This allows your HD controller to use the fast block mode to transfer data to and from your HD drive

Enabled	IDE controller uses block mode
Disabled	IDE controller uses standard mode

**IDE Primary Master/Slave PIO**  
**IDE Secondary Master/Slave PIO**

PIO - Programmed Input/Output, it allows the BIOS to tell the controller what it wants and then let the controller and the CPU to complete the task by themselves.

This is simpler and more faster. Your system supports five modes, 0 - 4, which primarily differ in timing. When **Auto** is selected, the BIOS will select the best available mode.

**IDE Primary Master/Slave UDMA**  
**IDE Secondary Master/Slave UDMA**

Auto, will support the Ultra DMA function.

Disabled, will not support the Ultra DMA function.

**On-Chip Primary PCI IDE**  
**On-Chip Secondary PCI IDE**

This setup item allows you to either enable or disable the primary/secondary controller. You might choose to disable the controller if you were to add higher performance or specialized controller.

**Onboard Audio Chip**

When enabled, the system will automatically detect sound card, if your system has a sound card on the mainboard.

When disabled, the system will not detect the sound card.

**USB Keyboard Support**

Enabled will support USB keyboard in Win95 2.1 and NT 5.0 or above operating system.

**Init AGP Display First**

This item will activate the AGP in the multi-display environment , it displayed, if disabled, and the system has both AGP and PCI VGA card, the AGP monitor will not display.

**Power On Function**

**KB Power On Password:** this function is available for ATX power only. User can select the power on method to power on the system. The options are the following :Password : when user select this option, it will show “Enter Password:”, after user type password, it will show “ Confirm Password:”, user should type the same password to confirm it. After power off, if user types the correct password, the system will power on.

**Hot Key :** when user select this option, it will show another line lines as Hot Key Power ON: Ctrl-F1” select any one you like. After power off, if user key in the control-F, it will power up the system.

**Mouse Left, Mouse Right :** it will power up the system by double click the left or right mouse. Note do not move your mouse between the first click and the second click.

**BUTTON ONLY :** only the power button can power the system.

**KBC input clock** Let user change the keyboard working clock.

**On Board FDC Controller** This item will enable or disable the floppy disk controller.

**On Board Serial Port 1** User can select serial port IRQ. If set to Auto, system will assign an IRQ for it. Note : set to Auto is not recommended.

**On Board Serial Port 2** User can select serial port IRQ. If set to Auto, system will assign an IRQ for it. Note : set to Auto is not recommended.

**UART Mode Select** This lets you select the Infrared mode. Choices are Standard, HPIR, and ASKIR. If you choose HPIR or ASKIR mode, the screen will show another two lines to let you choose ‘IR Function Duplex’ (Full or Half) and ‘RxD TxD Active’ (Hi Lo; Lo Hi; Hi Hi;Lo Lo).

**On Board Parallel Port** Let user select IRQ for parallel port, when Disabled, the parallel port will be disabled

**On Board Parallel Mode** Let user select error check mode. This item is not recommended to change except user has special request.

**ECP Mode Use DMA** Select a DMA channel for the port. Choices are 3, 1.

ROM PCI/ISA BIOS (ATC-6510)  
 CMOS SETUP UTILITY  
 AWARD SOFTWARE, INC.

STANDARD CMOS SETUP	INTEGRATED PERIPHERALS
BIOS FEATURES SETUP	SUPERVISOR PASSWORD
CHIPSET FEATURES SETUP	USER PASSWORD
POWER MANAGEMENT SETUP	IDE HDD AUTO DETECTION
PNP/PCI CONFIGURATION	SAVE & EXIT SETUP
LOAD BIOS DEFAULTS	EXIT WITHOUT SAVING
LOAD SETUP DEFAULTS	
ESC: Quit	↑↓→←:Select Item
F10: Save & Exit Setup	(Shift) F2 : Change Color
Time, Date, Hard Disk Type .....	

ROM PCI/ISA BIOS (ATC-6510)  
 CMOS SETUP UTILITY  
 AWARD SOFTWARE, INC.

Hard Disks	Type	Size	CYLS	HEAD	PRECOMP	LANDZ	SECTOR	MODE
Primary Master :								
Select Primary Master Option (N=Skip) : N								
<u>Options</u>	<u>Size</u>	<u>CYLS</u>	<u>Head</u>	<u>PRECOMP</u>	<u>LANDZ</u>	<u>Sector</u>	<u>Mode</u>	
2(Y)	1337	648	64	0	2594	63	LBA	
1	1339	2595	16	65535	2594	63	NORMAL	
3	1338	1297	32	65535	2594	63	LARGE	
Note : Some OSes (like SCO-UNIX) must use "Normal" for installation								
ESC : Skip								

The last step is 'save and exit'. If you select this item and press 'Y', then these records will be saved in the CMOS memory on the mainboard. It will be checked every time you turn your computer on.

ROM PCI/ISA BIOS (ATC-6510)

CMOS SETUP UTILITY

AWARD SOFTWARE, INC.

STANDARD CMOS SETUP	INTEGRATED PERIPHERALS
BIOS FEATURES SETUP	SUPERVISOR PASSWORD
CHIPSET FEATURES SETUP	USER PASSWORD
POWER MANAGEMENT SETUP	IDE HDD AUTO DETECTION
PNP/PCI CONFIGURATION	SAVE & EXIT SETUP
LOAD BIOS DEFAULTS	EXIT WITHOUT SAVING
LOAD SETUP DEFAULTS	
ESC: Quit	
↑↓→←:Select Item	
F10: Save & Exit Setup	
(Shift) F2 : Change Color	
Time, Date, Hard Disk Type .....	

ROM PCI/ISA BIOS (ATC-6510)

STANDARD CMOS SETUP

AWARD SOFTWARE, INC.

STANDARD CMOS SETUP	INTEGRATED PERIPHERALS
BIOS FEATURES SETUP	PASSWORD SETTING
CHIPSET FEATURES SETUP	IDE HDD AUTO DETECTION
POWER MANAGEMENT SETUP	SAVE & EXIT SETUP
PNP/PCI CONFIGURATION	EXIT WITHOUT SAVING
LOAD BIOS DEFAULTS	SAVE to CMOS and EXIT (Y/N):Y
ESC: Quit	
↑↓→←:Select Item	
F10: Save & Exit Setup	
(Shift) F2 : Change Color	
Save Data to CMOS & Exit SETUP	



## **LOAD BIOS DEFAULTS**

When your mainboard has problems and needs to trouble shoot the system, you can use this function. The default values loaded only affect the BIOS Features Setup, Chipset Features Setup, Power Management Setup and PNP/PCI Configuration Setup. There is no effect on the Standard CMOS Setup. To use this function, select it from main menu and press <Enter>. A line will appear on the screen asking if you want to load the BIOS default values. Press <Yes> and <Enter> then the BIOS default values will be loaded.

## **LOAD SETUP DEFAULTS**

This allows you to load optimal settings which are stored in the BIOS ROM. The default values loaded only affect the BIOS Features Setup, Chipset Features Setup, Power Management Setup and PNP/PCI Configuration Setup. There is no effect on the Standard CMOS Setup. To use this function, select it from main menu and press <Enter>. A line will appear on the screen asking if you want to load the Setup default values. Press <Yes> and <Enter> then the Setup default values will be loaded.

## **SUPERVISOR PASSWORD / USER PASSWORD**

This allows you to set the password. The mainboard defaults with password disabled.

**Enter/Change password :** Enter the current password, at the prompt, key-in your new password (up to eight alphanumeric characters), press <Enter>. At the next prompt, confirm the new password by typing it again and press <Enter>.

**Disable password :** Press the <Enter> key instead of entering a new password when the 'Enter Password' dialog box appears. A message will appear confirming that the password is disabled.

If you set both supervisor and user passwords, only the supervisor password allows you to enter the BIOS SETUP program.

**CAUTION** :If you forgot your password, you must disable the CMOS by turning power off and set JP 8 to ‘close’. And then open reload the system.

### **IDE HDD AUTO DETECTION**

This allows you to detect the IDE hard disk drivers‘ parameters and enter them into ‘Standard CMOS Setup’ automatically.

If the auto-detected parameters displayed do not match the ones that should be used for your hard drive, do not accept them. Press <N> to reject the values and enter the correct ones manually on the Standard CMOS Setup screen.

### **SAVE & EXIT SETUP**

This allows you to save the new setting values in the CMOS memory and continue with the booting process. Select what you want to do, press <Enter>.

### **EXIT WITHOUT SAVING**

This allows you to exit the BIOS setup utility without recording any new values or changing old ones.

## Control Key Description

UP ARROW		Move to previous item
DOWN ARROW		Move to next item
LEFT ARROW		Move to the item in the left hand
RIGHT ARROW		Move to the item in the right hand
Esc KEY	Esc	Main Menu : Quit and not save changes Setup menu : Exit current page and return to main menu
PgUp KEY		Increase the numeric value or make changes
PgDn KEY		Decrease the numeric value or make changes
F1 KEY	Help	General help
F2 KEY	< Shift > +F2	Change color from total 16 colors
F5 KEY	Old Value	Restore the pervious CMOS value from CMOS
F6 KEY	Load BIOS default	Load the default CMOS value from BIOS default table
F7 KEY	Load setup default	Load Setup default
F10 KEY	Save & Exit Setup	Save all the CMOS changes and Exit setup, only for Main Menu

**APPENDIX A**

**TECHNICAL SUPPORT REQUEST FORM**

If the mainboard doesn't function properly, please complete the following information and return it to your system dealer. If the further information is needed, please attach it.

Model No : ATC-6510      Date of Purchase : \_\_\_\_\_

Serial No : \_\_\_\_\_

**HARDWARE :**

	BRAND	MODEL	SPEED	Q'TY
DIM Module				

CPU SPEED : \_\_\_\_\_ MHz

DRAM : \_\_\_\_\_ MB ( \_\_\_\_\_ SDRAM/EDO DRAM)

Hard Disk Interface Controller : \_\_\_\_\_ IDE, \_\_\_\_\_ SCSI

Hard Disk Brand : \_\_\_\_\_, Model : \_\_\_\_\_, Capacity : \_\_\_\_\_

Display Controller Brand : \_\_\_\_\_, Model : \_\_\_\_\_

Controller Chip Brand : \_\_\_\_\_, Model : \_\_\_\_\_

**SOFTWARE:**

Award SYSTEM BIOS: Version \_\_\_\_\_ Date Code \_\_\_\_\_

Other Add-on Cards Information:

Add-on Card	Bus Interface	Model	Remark

Error Description