

MBC-6210 Series
Full-Size Socket 370 CPU Card
Version 1.0

Industrial CPU Card
PC-Based Computer Boards for Industrial Automation
User's Manual

Copyright Notice

This publication is protected by copyright and all rights are reserved. No part of it may be reproduced or transmitted by any means or in any form, without prior consent of the original manufacturer.

The information in this document has been carefully checked and is believed to be accurate. However, the original manufacturer assumes no responsibility for any inaccuracies that may appear in this manual. In no event will the original manufacturer be liable for direct, indirect, special, exemplary, incidental, incidental or consequential damages resulting from any defect or omission in this manual, even if advised of possibility of such damages. The material contained herein is for informational purposes only.

Acknowledgments

Award is a registered trademark of Award Software International, Inc.
PS/2 is a trademark of International Business Machines Corporation.
C&T is a trademark of Chips and Technologies Inc.
Intel and Celeron are registered trademarks of Intel Corporation.
Microsoft Windows is a registered trademark of Microsoft Corporation.
All other product names or trademarks are properties of their respective owners.

MBC-6210 Series Comparison Table

Model	MBC-6211	MBC-6210	MBC-6214	MBC-6217
Processor	Intel Celeron	Intel Celeron	Intel Celeron	Intel Celeron
Processor Socket	Socket 370	Socket 370	Socket 370	Socket 370
Chipset	Intel 440ZX	Intel 440ZX	Intel 440ZX	Intel 440ZX
BIOS	Award	Award	Award	Award
L2 cache	CPU Integrated	CPU Integrated	CPU Integrated	CPU Integrated
Max. SDRAM	512MB	512MB	512MB	512MB
Memory Sockets	2 x DIMM	2 x DIMM	2 x DIMM	2 x DIMM
VGA CRT/LCD	C&T 69000	C&T 69000	C&T 69000	no
Watchdog Timer	16-level	16-level	16-level	16-level
ISA High Drive	Yes	yes	yes	yes
Multi I/O Chip	Winbond 83977	Winbond 83977	Winbond 83977	Winbond 83977
Enhanced IDE	yes	Yes	Yes	yes
2S/1P	yes	Yes	Yes	yes
USB	yes	Yes	yes	yes
IrDA	yes	Yes	yes	yes
Ultra2 SCSI	no	Inic1060	no	No
Ethernet (10/100Mbps)	Realtek RTL8139A	Realtek RTL8139A	no	no
H/W Monitoring	Winbond W83781D	Winbond W83781D	Winbond W83781D	Winbond W83781D
Board Size	338mm x 122mm	338mm x 122mm	338mm x 122mm	338mm x 122mm

Remarks:

The MBC-6210 flexible design allows it to integrate VGA, Ethernet, and SCSI functions according to customer requirements. The following products are used in conjunction with the MBC-6210 CPU card:

- **MBC-110** C&T 69000 VGA MicroPCI Daughter Card
- **MBC-120** Realtek 8139B LAN MicroPCI Daughter Card
- **MBC-130** Initio Inic1060 SCSI MicroPCI Daughter Card
- **MBC-140** VGA+LAN MicroPCI Daughter Card
- **MBC-300** MicroPCI to PCI Card

Contents

Chapter 1 Introduction	1
Checklist.....	2
Introduction	3
Specifications	3
Intelligence	6
Board Dimensions	7
MicroPCI Daughter Cards and Adapter	8
Chapter 2 Installations	9
CPU Installation	10
MicroPCI Daughter Card Installation	10
Memory Installation.....	11
Jumpers on the MBC-6210.....	12
Connectors on the MBC-6210	20
Watchdog Timer Configuration	31
Chapter 3 BIOS Configuration.....	33
Chapter 4 Intel PIIX Bus Master IDE Driver Installation	57
Chapter 5 VGA Driver Installation.....	61
Chapter 6 LAN Driver Installation Guide.....	65
Chapter 7 System Monitor Utility	73
Chapter 8 LDCM Utility	81
Chapter 9 SCSI Installation Guide.....	89
Appendix	96
A. I/O Port Address Map.....	97
B. Interrupt Request Lines (IRQ).....	98

1

Introduction

This manual is designed to give you information on the MBC-6210 CPU card. It is divided into the following sections:

Checklist	2
Introduction	3
Specifications	3
Intelligence	6
Board Dimensions	7
MicroPCI Daughter Cards and Adapter.....	8

The topics covered in this chapter are as follows:

- ◆ Checklist
- ◆ Description
- ◆ Features
- ◆ Specifications
- ◆ Layout of Key Components and Dimensions

Checklist

Please check that your package is complete and contains the items below. If you discover damaged or missing items, please contact your dealer.

- The MBC-6210 Industrial CPU Card
- This User's Manual
- 1 IDE Ribbon Cable
- 1 Floppy Ribbon Connector
- 2 Serial Port Ribbon Cable and 1 Parallel Port Attached to a Mounting Bracket
- One 68-pin Ultra2 SCSI cable (applies for MBC-6210)
- 1 Diskette Containing Intel PCI IDE Driver and Flash Memory Utility
- 2 Diskettes Containing C&T 69000 VGA Driver (applies for MBC-6210/11/12/14)
- 2 Diskettes Containing Realtek 8139A LAN Driver (applies for MBC-6210/11/13/15)
- 2 Diskettes Containing Initio Inic1060 Ultra2 SCSI Driver (applies for MBC-6210/12/13/16)
- 1 Diskette Containing System Monitor utility
- 1 Optional CD containing *Intel LANDesk Client Manger*

Introduction

The MBC-6210 is the world's first MicroPCI CPU card. It integrates the Intel 440BX or 440ZX AGPset and supports a Socket 370 connector for Intel Celeron or Pentium III processors with frequencies of up to 600MHz. The **MicroPCI sockets** used are SO-DIMM 144-pin sockets that has 120 pins used for standard PCI signals and other pins for VGA and LAN signals.

Equipped with 2 **MicroPCI sockets**, users get to choose to insert VGA/LAN/SCSI MicroPCI cards. The MBC-300 MicroPCI to PCI adapter can also accommodate these MicroPCI cards.

The MBC-6210 is designed with a PCI bridge that is able to support 6 PCI master interface, unlike ordinary CPU cards, which only has 5-PCI master support. It comes with 2 MicroPCI and 4 master PCI interface.

MicroPCI CPU cards offer more reliability in performance and less failure rate in production by integrating all components in only one side of the PCB board. With components on one side, better design and improved quality control is achieved. The MBC-6210 MicroPCI CPU card is compatible with all types of PICMG backplane.

Specifications

- **Processor Socket:** Socket 370 connector
- **Processor:** Intel Celeron 300MHz~600MHz
- **Bus Speed:** 66MHz and 100MHz
- **Chipset:** Intel 440BX / 440ZX AGPset
- **Secondary Cache:** CPU integrated
- **Memory Sockets:**
 - Two (for 440ZX)/ Three (for 440BX) 168-pin DIMM sockets
 - Max. 512MB / 768MB SDRAM
 - Memory type: SDRAM (Synchronous DRAM)
 - NOTE: Only SDRAM modules that support SPD (Serial Presence Detect) should be use. Use PC100 modules when running 100MHz CPU bus speed and use PC66/PC100 modules when running 66MHz CPU bus speed.*

- **BIOS:** Award BIOS, PnP support
 - FLASH EEPROM (256KB) for BIOS update
 - ISA Plug and Play (PnP) extension
 - Power management
- **DMI BIOS Support:**
Desktop Management Interface (DMI) allows users to download system hardware-level information such as CPU type, CPU speed, internal/external frequencies and memory size.
- **Multi I/O:** Winbond W83977EF
- **Parallel Port:** One high-speed parallel port, SPP/EPP/ECP mode
- **Serial Port:** Two 16550 UART compatible ports with COM1 as RS232 and COM2 jumper configurable as RS232/422/485
- **Enhanced IDE:** Two Bus Mastering EIDE mode, up to 4 devices, Two EIDE interfaces for up to four devices, support PIO Mode 3/4 or Ultra DMA/33 IDE Hard Disk and ATAPI CD-ROM.
- **FDD Interface:** Two floppy drives (360KB, 720KB, 1.2MB, 1.44MB, 2.88MB, LS-120)
- **USB Interface:** Two USB pin-header connectors, compliant with USB Specification Rev. 1.0
- **DiskOnChip:** The M-Systems flash disk supports system boot and storage capacity from 2MB to 144MB.
- **Watchdog Timer:** 16-level, programmable
 - I/O port 0443H to enable watchdog.
 - I/O port 0441H to disable watchdog.
 - Time-out timing select 0/2/4/6/8/10/12/14/16/18/20/22/24/26/28/30 seconds (+/-20%).
- **VGA:** MBC-110 VGA MicroPCI Daughter Card (also available in MBC-140 VGA+LAN MicroPCI Daughter Card)
 - C&T 69000 VGA controller
 - Embedded 2MB SDRAM display memory
 - Simultaneous CRT & LCD display
 - LCD panel supports DSTN/TFT
 - 1280x1024x8bpp colors CRT resolution
 - Up to 1280x1024x8bpp colors resolution for color active matrix TFT panels (12, 18, and 24bit analog) or (12+12), (18+18) double pixel/CLK interface

- **Green Function:** Power management via BIOS, activated through mouse/keyboard movement
- **SCSI:** MBC-130 SCSI MicroPCI Daughter Card
 - Initio Inic 1060 Ultra2 SCSI controller
 - Inic1060 is a single-chip controller that provides a truly high performance SCSI solution. It combines Ultra2 data transfer rates of up to 80 MB/s with PCI burst rates of up to 133 MB/s to provide excellent I/O performance for high-end systems. An integrated 32-bit I/O processor significantly reduces host CPU utilization while requiring a maximum of one interrupt per I/O operation.
- **Ethernet:** MBC-120 LAN MicroPCI Daughter Card (also available in MBC-140 VGA+LAN MicroPCI Daughter Card)
 - Realtek RTL8139B Ethernet controller
 - The Realtek RTL8139B is a highly integrated and cost-effective single-chip Fast Ethernet controller that provides 32-bit performance, PCI bus master capability, and full compliance with IEEE 802.3u 100Base-T specifications and IEEE 802.3x Full Duplex Flow Control.
- **Keyboard and Mouse Connectors:** PS/2 type mini-DIN that supports PC/AT; supports a 5-pin external keyboard connector
- **IrDA Interface:** Pin-header connector for the optional IrDA external connector
- **PICMG Compliance:** Fully compliant to PICMG standards
- **Environmental and Mechanical:**
 - **Power Supply:** 10A @+5V(max), ±12V:100mA(max)
 - **Temperature:** 0°C to 60°C
 - **Humidity:** 5% to 95%
 - **Dimensions:** 338mm x 122mm

Intelligence

- **Temperature Monitoring and Alert:** A sensor for the CPU temperature on the MBC-6210 monitors the CPU temperature and alerts the user through the speaker or buzzer when temperature exceeds the safe heat level.
- **Windows 95/98 shut-off:** Allows shut-off control from within Windows 95/98 and through an ATX power supply.
- **Modem ring-on:** Allows system powering on through an external modem and through an ATX power supply.
- **Year 2000 Compliant BIOS:** The onboard Award BIOS is Year 2000 Compliant and will pass software applications that have the tendency to invoke INT1AH function 04H such as year2000.exe utility released by NSTL.
- **Wake On LAN:** Through an ATX power supply and network connection, systems can be turned on from the power-off state. Wake On LAN will function properly only with an ATX power supply with 5VSB that has 800mA.

Board Dimensions

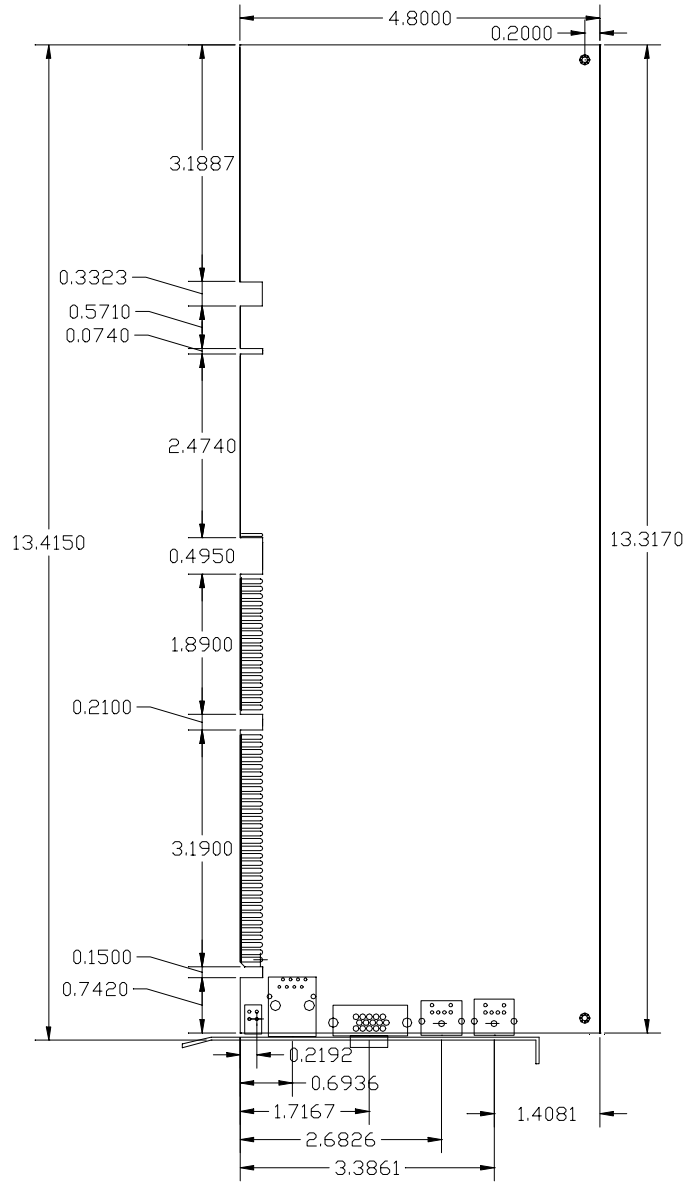

MicroPCI Daughter Cards and Adapter

MBC-110
VGA MicroPCI daughter card

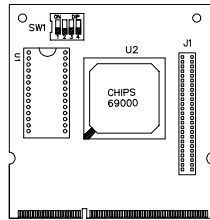

MBC-120
LAN MicroPCI daughter card

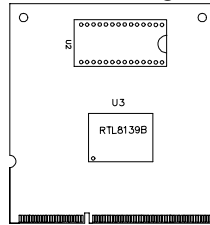

MBC-130 SCSI
MicroPCI daughter card

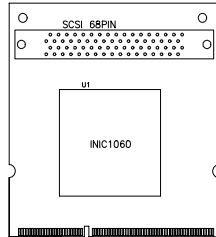

MBC-140 LAN+VGA
MicroPCI daughter card

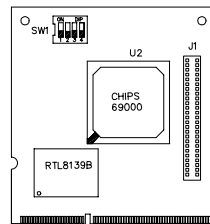

MBC-300 MicroPCI to PCI card

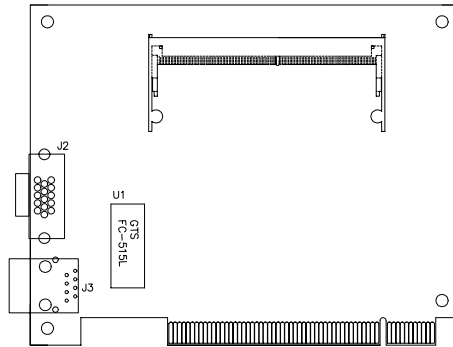

** Use the MBC-130 SCSI MicroPCI daughter card in the J22 MicroPCI socket on the MBC-6210 CPU card.*

2

Installations

This chapter provides information on how to use the jumpers and connectors on the MBC-6210 in order to set up a workable system. The topics covered are:

CPU Installation	10
MicroPCI Daughter Card Installation.....	10
Memory Installation.....	11
Jumpers on the MBC-6210.....	12
Connectors on the MBC-6210	20
Watchdog Timer Configuration.....	31

<p>CAUTION: Danger of explosion if battery is incorrectly replaced. Replace only with the same or equivalent type recommended by the manufacturer.</p>
--

CPU Installation

The MBC-6210 Industrial CPU Card supports a Socket 370 connector processor socket for Intel Celeron processors.

The Socket 370 connector comes with a lever to secure the processor. Before inserting the CPU, make sure the lever is raised perpendicular to the socket and the notch on the corner of the CPU corresponds with the notch on the inside of the socket.

After you have installed and lock the processor into place, check if the jumpers for the CPU type and speed are correct.

***NOTE:** Ensure that the CPU heat sink and the CPU top surface are in total contact to avoid CPU overheating problem that would cause your system to hang or be unstable.*

MicroPCI Daughter Card Installation

The MBC-6210 CPU card is integrated with two **MicroPCI sockets** that use SO-DIMM 144-pin connectors. These sockets can accommodate the VGA, Ethernet or SCSI MicroPCI daughter cards.

To insert the MicroPCI daughter cards, position it at 30° to the PCB and gently push it into the MicroPCI connector. (The card will not fit when inserted at an angle of 45° or 15°). Once inserted, slowly press the card towards the PCB until it locks on both sides to the clips of the connector. Screw the card to the PCB to secure the installation.

Memory Installation

The MBC-6210 Industrial CPU Card supports two 168-pin DIMM sockets for a maximum total memory of 512MB SDRAMs. In populating the DIMM sockets, any of the banks can be populated first.

NOTE: Use SDRAM modules with PC100 specification when running 100MHz CPU bus speed. With 66MHz bus speed, SDRAM modules with PC66 or PC100 specification can be used.

168-pin DIMM (3.3V) Unbuffer SDRAM



Bank0 (DIMM1)	Bank1 (DIMM2)	Total Memory
8MB	-----	8MB
16MB	-----	16MB
32MB	-----	32MB
64MB	-----	64MB
128MB	-----	128MB
256MB	-----	256MB
8MB	8MB	16MB
16MB	8MB	24MB
32MB	8MB	40MB
64MB	8MB	72MB
128MB	8MB	136MB
256MB	8MB	264MB
16MB	16MB	32MB
32MB	16MB	48MB
64MB	16MB	80MB
128MB	16MB	144MB
256MB	16MB	272MB
32MB	32MB	64MB
64MB	32MB	96MB
128MB	32MB	160MB
256MB	32MB	288MB
64MB	64MB	128MB
128MB	64MB	192MB
256MB	64MB	320MB
128MB	128MB	320MB
256MB	128MB	384MB
256MB	256MB	512MB

Jumpers on the MBC-6210 and Daughter Cards

The jumpers on the MBC-6210 allow you to configure your CPU card according to the needs of your applications. If you have doubts about the best jumper configuration for your needs, contact your dealer or sales representative. The following table lists the connectors on MBC-6210 and their respective functions.

Jumper Locations on the MBC-6210.....	13
DSW1 (1-8): CPU Frequency Selector	14
JP1: External Battery Connector	15
JP4: DiskOnChip BIOS Expansion Address Select	15
JP5: Clear CMOS Content	15
J15: RS232/422/485 (COM2) Selection.....	16
JP1: LCD Power Setting (MBC-110).....	16
J1: LCD Panel Connector (MBC-110)	17
JP1: Wake on LAN Connector (MBC-120)	18
Flat Panel Display Interface Pin Description.....	18
J1: Ultra2 SCSI Connector (MBC-130)	19

The following examples show the conventions used in this section.

	Jumper Open
	Jumper Closed



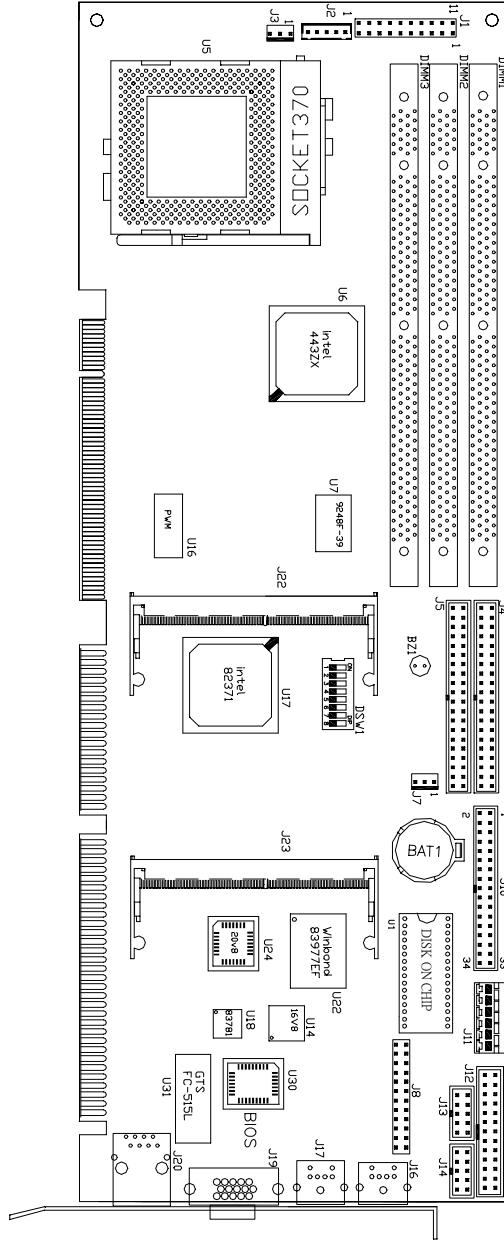

	Switch 1 and switch 2 are set to OFF. Switch 3 and switch 4 are set to ON.
---	---

Jumper Locations on the MBC-6210

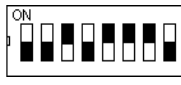
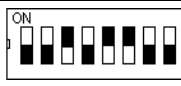
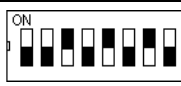
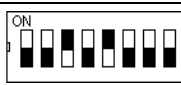

DSW1 (1-8): CPU Frequency Selector

The table below shows the correct setting to match the CPU frequency.

CPU Type	CPU Frequency	DSW1(1-8)
Celeron 66MHz Host Clock CPU	4.5x 66MHz 300MHz	 off off on off off on off on
	5x 66MHz 333MHz	 off off on off off on off on
	5.5x 66MHz 366MHz	 off off off off off off on on
	6x 66MHz 400MHz	 off off on off on on on off
	6.5x 66MHz 433MHz	 off off on off on on off off
	7x 66MHz 466MHz	 off off on off on on on off
	7.5x 66MHz 500MHz	 off off on off on on off off
	8x 66MHz 533MHz	 off off on off off on on off

JP1: External Battery Connector

This 4-pin connector allows the user to connect an external battery to maintain the information stored in the CMOS RAM in case the built-in battery malfunctions.

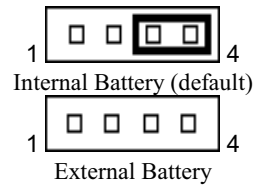

Pin #	Signal Name
1	Vcc
2	N.C.
3	Battery GND
4	Ground

JP4: DiskOnChip BIOS Expansion Address Select

JP4	Address
	D0000-D7FFF
	D8000-DFFFF (default)

JP5: Clear CMOS Content

JP5	Setting	Function
	Pin 2-3 Short/Closed	Clear CMOS Content
	Pin 1-2 Short/Closed	Normal Operation

J15: RS232/422/485 (COM2) Selection

COM1 is fixed for RS-232 use only.

COM2 is selectable for RS232, RS-422 and RS-485.

The following table describes the jumper settings of this connector.

COM2 Function	RS-232	RS-422	RS-485
Jumper Setting (pin closed)	all jumpers open	1-2 3-4 5-6 7-8 11-12 15-16 17-18 19-20 23-24	1-2 3-4 5-6 7-8 9-10 11-12 13-14 15-16 17-18 19-20 21-22
Jumper Illustration			

JP1: LCD Power Setting (MBC-110)

The MBC-110 C&T 69000 VGA MicroPCI daughter card supports 5V and 3.3V power. Use JP1 to change between 5V (*default*) and 3.3V panel video signal level.

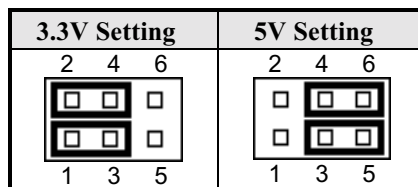

J1: LCD Panel Connector (MBC-110)

The MBC-110 C&T 69000 VGA MicroPCI daughter card supports LCD panels. Use J1 to connect the system to an LCD panel.

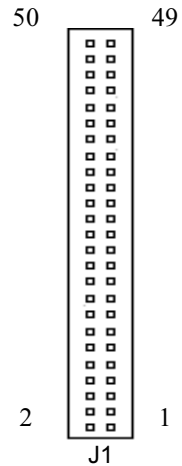

Signal Name	Pin #	Pin #	Signal Name
GND	1	2	P33
P34	3	4	P31
P35	5	6	P32
P30	7	8	P28
P29	9	10	P27
P25	11	12	P26
P24	13	14	P21
P23	15	16	P22
P16	17	18	P20
P17	19	20	P18
P19	21	22	P14
P13	23	24	P12
P15	25	26	P11
P7	27	28	P10
5V or 3.3V	29	30	5V or 3.3V
P9	31	32	P8
P4	33	34	P6
P3	35	36	P5
P2	37	38	P1
M	39	40	P0
SHFCLK	41	42	ENABKL
FPVDD	43	44	FLM(V SYS)
FPVEE	45	46	LP(H SYS)
GND	47	48	GND
+12V	49	50	+12V

Flat Panel Display Interface Pin Descriptions

	Mono SS	Mono DD	Mono DD	Color TFT	Color TFT	Color TFT	Color TFT	Color TFT+HR	Color STN-SS	Color STN-SS	Color STN-DD	Color STN-DD
Pin Name	8-bit	8-bit	16-bit	9/12/16 bit	18/24 bit	36-bit	18/24 bit	8-bit (4bP)	16-bit (4bP)	8-bit (4bP)	16-bit (4bP)	24-bit
P0	D0	UD3	UD7	B0	B0	FB0	FB0	R1	R1	UR1	UR0	UR0
P1	D1	UD2	UD6	B1	B1	FB1	FB1	B1	G1	UG1	UG0	UG0
P2	D2	UD1	UD5	B2	B2	FB2	FB2	G2	B1	UB1	UB0	UB0
P3	D3	UD0	UD4	B3	B3	FB3	FB3	B3	R2	UB2	UR1	LR0
P4	D4	LD3	UD3	B4	B4	FB4	SB0	G4	G3	LR1	LR0	LG0
P5	D5	LD2	UD2	G0	B5	FB5	SB1	R5	B2	LG1	LG0	LB0
P6	D6	LD1	UD1	G1	B6	SB0	SB2	B5	R3	LB1	LB0	UR1
P7	D7	LD0	UD0	G2	B7	SB1	B3		G3	LR2	LR1	UG1
P8			LD7	G3	G0	SB2	FG0		B3		UG1	UB1
P9			LD6	G4	G1	SB3	FG1		R4		UB1	LR1
P10			LD5	G5	G2	SB4	FG2		G4		UR2	LG1
P11			LD4	R0	G3	SB5	FG3		B4		UG2	LB1
P12			LD3	R1	G4	FG0	SG0		R5		LG1	UR2
P13			LD2	R2	G5	FG1	SG1		G5		LB1	UG2
P14			LD1	R3	G6	FG2	SG2		B5		LR2	UB2
P15			LD0	R4	G7	FG3	SG3		G6		LG2	LR2
P16					R0	FG4	FR0					LG2
P17					R1	FG5	FR1					LB2
P18					R2	SG0	FR2					UR3
P19					R3	SG1	FR3					UG3
P20					R4	SG2	SR0					LR3
P21					R5	SG3	SR1					LG3
P22					R6	SG4	SR2					LB3
P23					R7	SG5	SR3					
P24						FR0						
P25						FR1						
P26						FR2						
P27						FR3						
P28						FR4						
P29						FR5						
P30						SR0						
P31						SR1						
P32						SR2						
P33						SR3						
P34						SR4						
P35						SR5						
SHFCLK	SHFCLK	SHFCLK	SHFCLK	SHFCLK	SHFCLK	SHFCLK	SHFCLK	SHFCLK	SHFCLK	SHFCLK	SHFCLK	SHFCLK
Pixels/Clk:	8	8	16	1	1	2	2	2-2/3	5-1/3	2-2/3	5-1/3	8

JP1: Wake On LAN Connector (MBC-120)

The MBC-120 Realtek 8139B LAN MicroPCI daughter card supports the JP1 Wake on LAN connector. The following table shows the pin out assignments of this connector. Wake On LAN will function properly only with an ATX power supply with 5VSB that has 800mA.

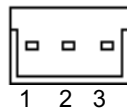

Pin #	Signal Name
1	+5VSB
2	Ground
3	Wake on LAN

J1: Ultra2 SCSI Connector (MBC-130)

The MBC-130-A1 Initio Inic1060 SCSI MicroPCI daughter card supports a 68-pin SCSI connector. The table below shows its pin-out assignments.

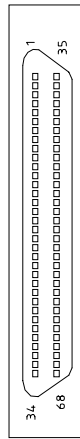

J1

Signal Name	Pin #	Pin #	Signal Name
LVDP12	1	35	LVDM12
LVDP13	2	36	LVDM13
LVDP14	3	37	LVDM14
LVDP15	4	38	LVDM15
LVDPHP	5	39	LVDPHM
LVDP0	6	40	LVDM0
LVDP1	7	41	LVDM1
LVDP2	8	42	LVDM2
LVDP3	9	43	LVDM3
LVDP4	10	44	LVDM4
LVDP5	11	45	LVDM5
LVDP6	12	46	LVDM6
LVDP7	13	47	LVDM7
LVDPPLP	14	48	LVDPPLM
GROUND	15	49	GROUND
DFFSENSE	16	50	LVEXT68
GROUND	17	51	LVTRMPWR
LVTRMPWR	18	52	LVTRMPWR
LVTRMPWR	19	53	N.C.
GROUND	20	54	GROUND
LVATNP	21	55	LVATNM
GROUND	22	56	GROUND
LVBSYP	23	57	LVBSYM
LVACKP	24	58	LVACKM
LVRSTP	25	59	LVRSTM
LVMSGP	26	60	LVMSGM
LVSELP	27	61	LVSELM
LVCDP	28	62	LVCDM
LVREQP	29	63	LVREQM
LVIOP	30	64	LVIOM
LVDP8	31	65	LVDM8
LVDP9	32	66	LVDM9
LVDP10	33	67	LVDM10
LVDP11	34	68	LVDM11

Connectors on the MBC-6210

The connectors on the MBC-6210 allows you to connect external devices such as keyboard, floppy disk drives, hard disk drives, printers, etc. The following table lists the connectors on MBC-6210 and their respective functions.

Connector Locations on the MBC-6210.....	21
J1: Front Bezel Connector.....	22
J2: External Keyboard Connector	24
JP2: Wake On LAN Connector	24
J3: CPU Fan Power Connector.....	24
J4, J5: EIDE Connectors	25
J6: External ATX Power Connector.....	26
JP6: IrDA Connector	26
J7: System Fan Power Connector	26
J8, J9: USB Connectors.....	26
J10: Floppy Drive Connector	27
J11: P8 AT Power Connector	27
J12: Parallel Port Connector.....	28
J13, J14: COM1 Serial Port	28
J16: PS/2 Keyboard Connector	29
J17: PS/2 Mouse Connector	29
J19: VGA CRT Connector	29
J20: RJ45 Connector	30
J22, J23: MicroPCI Connector	30

Connector Locations on the MBC-6210

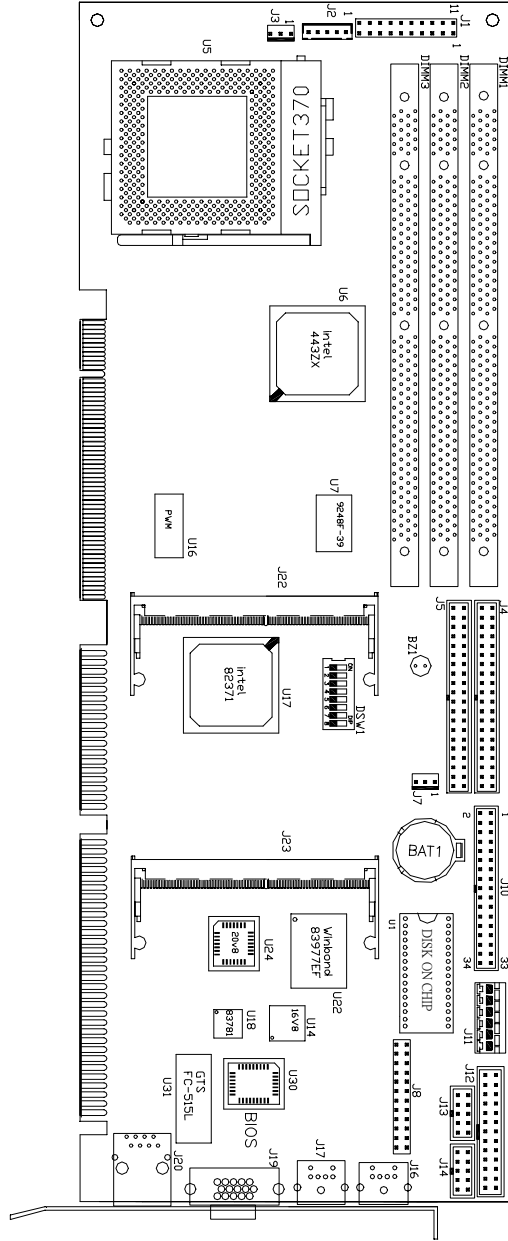

J1: Front Bezel Connector

The front bezel of the case has a control panel that provides light indication of the computer activities and switches to change the computer status. J1 is a 20-pin header that provides interfaces for the following functions.

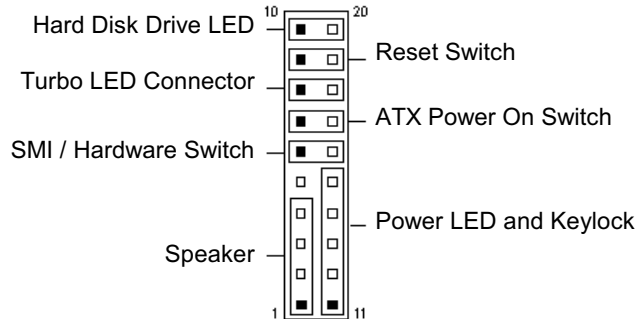

Speaker: Pins 1 - 4

This connector provides an interface to a speaker for audio tone generation. An 8-ohm speaker is recommended.



Pin #	Signal Name
1	Speaker out
2	No connect
3	Ground
4	+5V

Power LED and Keylock: Pins 11 - 15

The power LED indicates the status of the main power switch. The keylock switch, when closed, will disable the keyboard function.



Pin #	Signal Name
11	Power LED
12	No connect
13	Ground
14	Keylock
15	Ground

SMI/Hardware Switch: Pins 6 and 16

This connector supports the "Green Switch" on the control panel, which, when pressed, will force the system into the power-saving mode immediately.

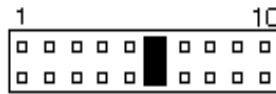

Pin #	Signal Name
6	Sleep
16	Ground

ATX Power ON Switch: Pins 7 and 17

This 2-pin connector is an "ATX Power Supply On/Off Switch" on the system that connects to the power switch on the case. When pressed, the power switch will force the system to power on. When pressed again, it will force the system to power off.

**Turbo LED Connector: Pins 8 and 18**

There is no turbo/deturbo function on the CPU card. The Turbo LED on the control panel will always be On when attached to this connector.

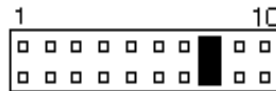

Pin #	Signal Name
8	5V
18	Ground

Reset Switch: Pins 9 and 19

The reset switch allows the user to reset the system without turning the main power switch off and then on again. Orientation is not required when making a connection to this header.

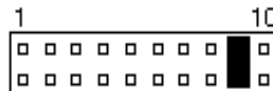

Hard Disk Drive LED Connector: Pins 10 and 20

This connector connects to the hard drive activity LED on control panel. This LED will flash when the HDD is being accessed.

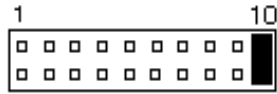

Pin #	Signal Name
10	Ground
20	5V

J2: External Keyboard Connector



Pin #	Signal Name
1	Keyboard clock
2	Keyboard data
3	NC
4	GND
5	Vcc

JP2: Wake On LAN Connector

JP2 is a 3-pin header for the Wake On LAN function on the CPU card. The following table shows the pin out assignments of this connector. Wake On LAN will function properly only with an ATX power supply with 5VSB that has 200mA.

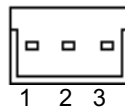

Pin #	Signal Name
1	+5VSB
2	Ground
3	Wake on LAN

J3: CPU Fan Power Connector

J3 is a 3-pin header for the CPU fan. The fan must be a 12V fan.

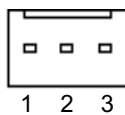

Pin #	Signal Name
1	Rotation
2	+12V
3	Ground

J4, J5: EIDE Connectors

J4: Primary IDE Connector

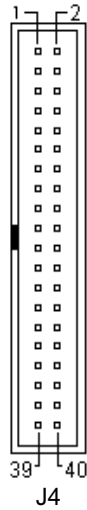

Signal Name	Pin #	Pin #	Signal Name
Reset IDE	1	2	Ground
Host data 7	3	4	Host data 8
Host data 6	5	6	Host data 9
Host data 5	7	8	Host data 10
Host data 4	9	10	Host data 11
Host data 3	11	12	Host data 12
Host data 2	13	14	Host data 13
Host data 1	15	16	Host data 14
Host data 0	17	18	Host data 15
Ground	19	20	Key
DRQ0	21	22	Ground
Host IOW	23	24	Ground
Host IOR	25	26	Ground
IOCHRDY	27	28	Host ALE
DACK0	29	30	Ground
IRQ14	31	32	No connect
Address 1	33	34	No connect
Address 0	35	36	Address 2
Chip select 0	37	38	Chip select 1
Activity	39	40	Ground

J5: Secondary IDE Connector

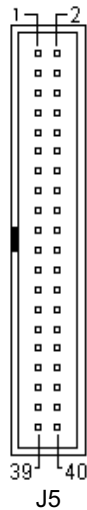

Signal Name	Pin #	Pin #	Signal Name
Reset IDE	1	2	Ground
Host data 7	3	4	Host data 8
Host data 6	5	6	Host data 9
Host data 5	7	8	Host data 10
Host data 4	9	10	Host data 11
Host data 3	11	12	Host data 12
Host data 2	13	14	Host data 13
Host data 1	15	16	Host data 14
Host data 0	17	18	Host data 15
Ground	19	20	Key
DRQ1	21	22	Ground
Host IOW	23	24	Ground
Host IOR	25	26	Ground
IOCHRDY	27	28	Host ALE
DACK1	29	30	Ground
IRQ15	31	32	No connect
Address 1	33	34	No connect
Address 0	35	36	Address 2
Chip select 0	37	38	Chip select 1
Activity	39	40	Ground

J6: External ATX Power Connector

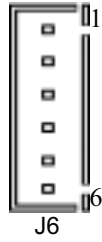

Pin #	Signal Name
1	N.C.
2	GND
3	N.C.
4	GND
5	PS-ON (soft on/off)
6	5V SB (standby +5V)

JP6: IrDA Connector

JP6 is used for an IrDA connector for wireless communication.

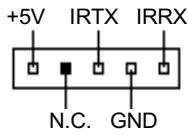

Pin #	Signal Name
1	+5V
2	No connect
3	Ir TX
4	Ground
5	Ir RX

J7: System Fan Power Connector

J7 is a 3-pin header for the system fan. The fan must be a 12V fan.

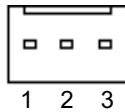

Pin #	Signal Name
1	Rotation
2	+12V
3	Ground

J8, J9: USB Connectors

The following table shows the pin outs of the USB connectors.

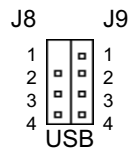

J8 Pin #	J9 Pin #	Signal Name
1	1	Vcc
2	2	USB-
3	3	USB+
4	4	Ground

J10: Floppy Drive Connector

J10 is a 34-pin header and will support up to 2.88MB floppy drives.

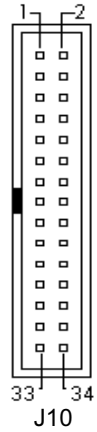

Signal Name	Pin #	Pin #	Signal Name
Ground	1	2	RM/LC
Ground	3	4	No connect
Ground	5	6	No connect
Ground	7	8	Index
Ground	9	10	Motor enable 0
Ground	11	12	Drive select 1
Ground	13	14	Drive select 0
Ground	15	16	Motor enable 1
Ground	17	18	Direction
Ground	19	20	Step
Ground	21	22	Write data
Ground	23	24	Write gate
Ground	25	26	Track 00
Ground	27	28	Write protect
Ground	29	30	Read data
Ground	31	32	Side 1 select
Ground	33	34	Diskette change

J11: P8 AT Power Connector



Pin #	Signal Name
1	N.C.
2	+5V
3	+12V
4	-12V
5	Ground
6	Ground

J12: Parallel Port Connector

The following table describes the pin out assignments of this connector.

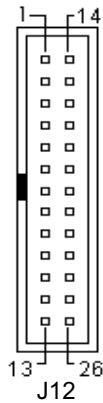

Signal Name	Pin #	Pin #	Signal Name
Line printer strobe	1	14	AutoFeed
PD0, parallel data 0	2	15	Error
PD1, parallel data 1	3	16	Initialize
PD2, parallel data 2	4	17	Select
PD3, parallel data 3	5	18	Ground
PD4, parallel data 4	6	19	Ground
PD5, parallel data 5	7	20	Ground
PD6, parallel data 6	8	21	Ground
PD7, parallel data 7	9	22	Ground
ACK, acknowledge	10	23	Ground
Busy	11	24	Ground
Paper empty	12	25	Ground
Select	13	N/A	N/A

J13, J14: COM1 Serial Port

J13 and J14 both 10-pin header connectors, are the onboard serial ports of the MBC-6210. The following table shows the pin assignments of this connector.

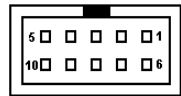

Pin #	Signal Name
1	DCD, Data carrier detect
2	RXD, Receive data
3	TXD, Transmit data
4	DTR, Data terminal ready
5	GND, ground
6	DSR, Data set ready
7	RTS, Request to send
8	CTS, Clear to send
9	RI, Ring indicator
10	NC

J14: COM1
J13: COM2

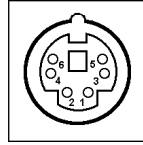
J16: PS/2 Keyboard Connector

J16

Pin #	Signal Name
1	Keyboard data
2	N.C.
3	GND
4	5V
5	Keyboard clock
6	N.C.

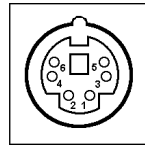
J17: PS/2 Mouse Connector

J17

Pin #	Signal Name
1	Mouse data
2	N.C.
3	N.C.
4	5V
5	Mouse Clock
6	N.C.

J19: VGA CRT Connector

The pin assignments of the J18 VGA CRT connector are as follows:

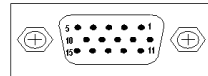

J18

Signal Name	Pin	Pin	Signal Name
Red	1	2	Green
Blue	3	4	N.C.
GND	5	6	GND
GND	7	8	GND
N.C.	9	10	GND
N.C.	11	12	N.C.
HSYNC	13	14	VSYNC
NC	15		

J20: RJ45 Connector

This connector is for the 10/100Mbps Ethernet capability of the CPU card. The figure below shows the pin out assignments of this connector and its corresponding input jack.

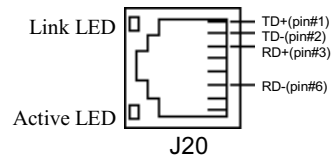

J22, J23: MicroPCI Connector

J22 and J23 are MicroPCI connectors supporting the Micro daughter cards with VGA, Ethernet or SCSI function.

Watchdog Timer Configuration

The function of the watchdog timer is to reset the system automatically and is defined at I/O port 0443H. To enable the watchdog timer and allow the system to reset, write I/O port 0443H. To disable the timer, write I/O port 0441H for the system to stop the watchdog function. The timer has a tolerance of 20% for its intervals.

The following describes how the timer should be programmed.

Enabling Watchdog:

```
MOV  AX, 000FH (Choose the values from 0)
MOV  DX, 0443H
OUT  DX, AX
```

Disabling Watchdog

```
MOV  AX, 00FH (Any value is fine.)
MOV  DX, 0441H
OUT  DX, AX
```

WATCHDOG TIMER CONTROL TABLE

Level	Value	Time/sec	Level	Value	Time/sec
1	F	0	9	7	16
2	E	2	10	6	18
3	D	4	11	5	20
4	C	6	12	4	22
5	B	8	13	3	24
6	A	10	14	2	26
7	9	12	15	1	28
8	8	14	16	0	30

This page was intentionally left blank.

3

BIOS Configuration

This chapter describes the different settings available in the Award BIOS that comes with the CPU card. The topics covered in this chapter are as follows:

BIOS Introduction.....	36
BIOS Setup	36
Standard CMOS Setup	38
Date	38
Time	39
Primary HDDs / Secondary HDDs	39
Drive A / Drive B	40
Video	40
Halt On	40
BIOS Features Setup.....	41
Virus Warning	41
CPU Internal Cache / External Cache.....	41
CPU L2 Cache ECC Checking.....	41
Processor Number Feature.....	37
Quick Power On Self Test.....	42
Boot Sequence.....	42
Swap Floppy Drive.....	42
Boot Up Floppy Seek	42
Boot Up NumLock Status.....	42
Boot Up System Speed.....	42
Gate A20 Option	42
Typematic Rate Setting.....	42
Typematic Rate (Chars/Sec).....	43
Typematic Delay (Msec)	43
Security Option.....	43

PCI/VGA Palette Snoop	43
OS Select for DRAM > 64MB	43
Report No FDD For WIN 95	43
Video BIOS Shadow.....	43
C8000 - CBFFF Shadow/DC000 - DFFFF Shadow	43
Chipset Features Setup	44
SDRAM RAS-to-CAS Delay.....	44
SDRAM RAS Precharge Time	44
SDRAM CAS Latency Time	44
SDRAM Precharge Control.....	40
System BIOS Cacheable	44
Video BIOS Cacheable.....	45
Video RAM Cacheable.....	45
8 Bit I/O Recovery Time	45
16 Bit I/O Recovery Time	45
Memory Hole at 15MB - 16MB	45
Passive Release.....	45
Delayed Transaction	41
AGP Aperture Size (MB)	41
Auto Detect DIMM/PCI Clock.....	42
Spread Spectrum.....	42
CPU Host Clock (CPU/PCI).....	42
CPU Warning Temperature	46
Current CPU/Chips Temp. / Current System Temp.	46
Current CPU Fan Speed/Chassis Fan Speed	46
VCCP / VTT / VCC3.....	46
Power Management Setup	47
Power Management	47
PM Control by APM.....	48
Video Off Method.....	48
Video Off After.....	48
Modem Use IRQ.....	48
Doze Mode	48
Standby Mode.....	48
Suspend Mode	48
HDD Power Down.....	48
Throttle Duty Cycle	48
PCI VGA Active Monitor	49
Soft-Off by PWR-BTTN	49
PWR On by Modem/LAN	49
Resume by Alarm.....	49
IRQ 8 Break Suspend	49
Reload Global Timer Events.....	49

PNP/PCI Configuration.....	50
PNP OS Installed.....	50
Resources Controlled by.....	50
Reset Configuration Data	50
IRQ3/4/5/7/9/10/11/12/14/15, DMA0/1/3/5/6/7 assigned to	50
Load BIOS Defaults.....	51
Load Setup Defaults.....	51
Integrated Peripherals	52
IDE HDD Block Mode.....	52
IDE Primary/Secondary Master/Slave PIO	52
IDE Primary/Secondary Master/Slave UDMA	52
On-Chip Primary/Secondary PCI IDE.....	53
USB Keyboard Support.....	53
Init AGP Display First.....	53
Onboard FDC Controller.....	53
Onboard Serial/Parallel Port.....	53
UART Mode Select	53
Parallel Port Mode.....	53
Supervisor / User Password	54
IDE HDD Auto Detection.....	55
Save & Exit Setup	56
Exit Without Saving.....	56

BIOS Introduction

The Award BIOS (Basic Input/Output System) installed in your computer system's ROM supports Intel Pentium II processors in a standard IBM-AT compatible I/O system. The BIOS provides critical low-level support for a standard device such as disk drives, serial ports and parallel ports. It also adds virus and password protection as well as special support for detailed fine-tuning of the chipset controlling the entire system.

BIOS Setup

The Award BIOS provides a Setup utility program for specifying the system configurations and settings. The BIOS ROM of the system stores the Setup utility. When you turn on the computer, the Award BIOS is immediately activated. Pressing the key immediately allows you to enter the Setup utility. If you are a little bit late pressing the key, POST (Power On Self Test) will continue with its test routines, thus preventing you from invoking the Setup. If you still wish to enter Setup, restart the system by pressing the "Reset" button or simultaneously pressing the <Ctrl>, <Alt> and <Delete> keys. You can also restart by turning the system Off and back On again. The following message will appear on the screen:

Press to Enter Setup

In general, you press the arrow keys to highlight items, <Enter> to select, the <PgUp> and <PgDn> keys to change entries, <F1> for help and <Esc> to quit.

When you enter the Setup utility, the Main Menu screen will appear on the screen. The Main Menu allows you to select from various setup functions and exit choices.

ROM PCI/ISA BIOS
CMOS SETUP UTILITY
AWARD SOFTWARE, INC.

STANDARD CMOS SETUP	INTEGRATED PERIPHERALS
BIOS FEATURES SETUP	SUPERVISOR PASSWORD
CHIPSET FEATURES SETUP	USER PASSWORD
POWER MANAGEMENT SETUP	IDE HDD AUTO DETECTION
PNP/PCI CONFIGURATION	SAVE & EXIT SETUP
LOAD BIOS DEFAULTS	EXIT WITHOUT SAVING
LOAD SETUP DEFAULTS	
ESC : Quit	↑ ↓ → ← : Select Item
F10 : Save & Exit Setup	(Shift) F2 : Change Color
Time, Date, Hard Disk Type	

The section below the setup items of the Main Menu displays the control keys for this menu. At the bottom of the Main Menu just below the control keys section, there is another section which displays information on the currently highlighted item in the list.

NOTE: *If your computer cannot boot after making and saving system changes with Setup, the Award BIOS supports an override to the CMOS settings that resets your system to its default.*

We strongly recommend that you avoid making any changes to the chipset defaults. These defaults have been carefully chosen by both Award and your system manufacturer to provide the absolute maximum performance and reliability.

Standard CMOS Setup

The “Standard CMOS Setup” choice allows you to record some basic hardware configurations in your computer system and set the system clock and error handling. If the motherboard is already installed in a working system, you will not need to select this option. You will need to run the Standard CMOS option, however, if you change your system hardware configurations, the onboard battery fails, or the configuration stored in the CMOS memory was lost or damaged.

ROM PCI/ISA BIOS STANDARD CMOS SETUP AWARD SOFTWARE, INC.								
Date (mm:dd:yy) : Wed, Mar 4 1998								
Time (hh:mm:ss) : 00 : 00 : 00								
HARD DISKS	TYPE	SIZE	CYLS	HEAD	PRECOMP	LANDZ	SECTOR	MODE
Primary Master	Auto	0	0	0	0	0	0	Auto
Primary Slave	Auto	0	0	0	0	0	0	Auto
Secondary Master	Auto	0	0	0	0	0	0	Auto
Secondary Slave	Auto	0	0	0	0	0	0	Auto
Drive A	: 1.44M, 3.5in			Base Memory		: 640K		
Drive B	: None			Extended Memory		: 15360K		
Video	: EGA / VGA			Other Memory		: 384K		
Halt On	: All Errors			Total Memory		: 16384K		
ESC : Quit			↑ ↓ → ← : Select			Item PU / PD / + / - : Modify		
F1 : Help			(Shift) F2 : Change Color					

At the bottom of the menu are the control keys for use on this menu. If you need any help in each item field, you can press the <F1> key. It will display the relevant information to help you. The memory display at the lower right-hand side of the menu is read-only. It will adjust automatically according to the memory changed. The following describes each item of this menu.

Date

The date format is:

Day : Sun to Sat
Month : 1 to 12
Date : 1 to 31
Year : 1994 to 2079

To set the date, highlight the “Date” field and use the PageUp/ PageDown or +/- keys to set the current time.

Time

The time format is: **Hour : 00 to 23**
Minute : 00 to 59
Second : 00 to 59

To set the time, highlight the “Time” field and use the <PgUp>/<PgDn> or +/- keys to set the current time.

Primary HDDs / Secondary HDDs

The onboard PCI IDE connectors provide Primary and Secondary channels for connecting up to four IDE hard disks or other IDE devices. Each channel can support up to two hard disks; the first is the “Master” and the second is the “Slave”.

To enter the specifications for a hard disk drive, you must select first a “Type”. There are 45 predefined types and 4 user definable types are for Enhanced IDE BIOS. Type 1 to 45 are predefined. Type “User” is user-definable. For the Primary Master/Slave as well as Secondary Master/Slave, you can select “Auto” under the TYPE and MODE fields. This will enable auto detection of your IDE drives and CD-ROM drive during POST.

Press <PgUp>/<PgDn> to select a numbered hard disk type or type the number and press the <Enter> key. The hard disk will not work properly if you enter incorrect information for this field. If your hard disk drive type is not matched or listed, you can use Type User to define your own drive type manually. If you select Type User, related information is asked to be entered to the following items.

CYLS : Number of cylinders
HEAD : Number of read/write heads
PRECOMP : Write precompensation
LANDZ : Landing zone
SECTOR : Number of sectors
SIZE : Automatically adjust according to the configuration
MODE (for IDE HDD only) : Auto
Normal (HD < 528MB)
Large (for MS-DOS only)
LBA (HD > 528MB and supports
Logical Block Addressing)

NOTE: *The specifications of your drive must match with the drive table. The hard disk will not work properly if you enter incorrect information in these fields. If your hard disk drive type is not matched or listed, you can use Type User to define your own drive type manually.*

Drive A / Drive B

These fields identify the types of floppy disk drive A or drive B that has been installed in the computer. The available specifications are:

360KB 1.2MB 720KB 1.44MB 2.88MB
5.25 in. 5.25 in. 3.5 in. 3.5 in. 3.5 in.

Video

This field selects the type of video display card installed in your system. You can choose the following video display cards:

EGA/VGA	For EGA, VGA, SEGA, SVGA or PGA monitor adapters. (default)
CGA 40	Power up in 40 column mode.
CGA 80	Power up in 80 column mode.
MONO	For Hercules or MDA adapters.

Halt On

This field determines whether the system will halt if an error is detected during power up.

No errors	The system boot will not be halted for any error that may be detected. (default)
All errors	Whenever the BIOS detects a non-fatal error, the system will stop and you will be prompted.
All, But Keyboard	The system boot will not be halted for a keyboard error; it will stop for all other errors
All, But Diskette	The system boot will not be halted for a disk error; it will stop for all other errors.
All, But Disk/Key	The system boot will not be halted for a keyboard or disk error; it will stop for all others.

BIOS Features Setup

This section allows you to configure and improve your system and allows you to set up some system features according to your preference.

ROM / PCI ISA BIOS
BIOS FEATURES SETUP
AWARD SOFTWARE, INC.

Virus Warning	: Disabled	Video BIOS Shadow	: Enabled
CPU Internal Cache	: Enabled	C8000-CBFFF Shadow	: Disabled
External Cache	: Enabled	CC000-CFFFF Shadow	: Disabled
CPU L2 Cache ECC Checking	: Enabled	D0000-D3FFF Shadow	: Disabled
Processor Number Feature	: Enabled	D4000-D7FFF Shadow	: Disabled
Quick Power On Self Test	: Enabled	D8000-DBFFF Shadow	: Disabled
Boot Sequence	: A, C, SCSI	DC000-DFFF Shadow	: Disabled
Swap Floppy Drive	: Disabled		
Boot Up Floppy Drive	: Enabled		
Boot Up Numlock Status	: On		
Gate A20 Option	: Fast		
Typematic Rate Setting	: Disabled		
Typematic Rate (chars/Sec)	: 6		
Typematic Delay (Msec)	: 250		
Security Option	: Setup		
PCI /VGA Palette Snoop	: Disabled	ESC : Quit	↑ ↓ → ← : Select Item
OS Select For DRAM>64MB	: Non-OS2	F1 : Help	PU/PD/+/- : Modify
Report No FDD For WIN 95	: No	F5 : Old Values	(Shift) F2 : Color
		F6 : Load BIOS Defaults	
		F7 : Load Setup Defaults	

Virus Warning

This item protects the boot sector and partition table of your hard disk against accidental modifications. If an attempt is made, the BIOS will halt the system and display a warning message. If this occurs, you can either allow the operation to continue or run an anti-virus program.

CPU Internal Cache / External Cache

When the CPU requests data, the system transfers the requested data from the main DRAM into cache memory, for even faster access by the CPU. These items allow you to enable (speed up memory access) or disable the cache function. By default, these items are *Enabled*.

CPU L2 Cache ECC Checking

When enabled, this allows ECC checking of the CPU's L2 cache. By default, this field is *Enabled*.

Processor Number Feature

This field only appears if the processor on board is a Pentium III processor. The Processor Number Feature can be enabled or disabled.

Quick Power On Self Test

When enabled, this field speeds up the Power On Self Test (POST) after the system is turned on. If it is set to *Enabled*, BIOS will skip some items.

Boot Sequence

This field determines the drive that the system searches first for an operating system. The options are:

A, C, SCSI	D, A, SCSI	SCSI, C, A
C, A, SCSI	E, A, SCSI	C only
C, CDROM, A	F, A, SCSI	LS/ZIP, C
CDROM, C, A	SCSI, A, C	

The default value is *A, C, SCSI*.

Swap Floppy Drive

This item allows you to determine whether or not to enable Swap Floppy Drive. When enabled, the BIOS swaps floppy drive assignments so that Drive A becomes Drive B, and Drive B becomes Drive A. By default, this field is set to *Disabled*.

Boot Up Floppy Seek

When enabled, the BIOS will seek whether or not the floppy drive installed has 40 or 80 tracks. 360K type has 40 tracks while 760K, 1.2M and 1.44M all have 80 tracks. By default, this field is set to *Enabled*.

Boot Up NumLock Status

This allows you to activate the NumLock function after you power up the system. By default, the system boots up with *NumLock* On.

Boot Up System Speed

This has no function and selects the default system speed (*High*).

Gate A20 Option

This field allows you to select how Gate A20 is worked. Gate A20 is a device used to address memory above 1 MB. The default setting is *Fast*.

Typematic Rate Setting

When disabled, continually holding down a key on your keyboard will generate only one instance. When enabled, you can set the two typematic controls listed next. By default, this field is set to *Disabled*.

Typematic Rate (Chars/Sec)

When the typematic rate is enabled, the system registers repeated keystrokes speeds. You can select speed range from 6 to 30 characters per second. By default, this item is set to **6**.

Typematic Delay (Msec)

When the typematic rate is enabled, this item allows you to set the time interval for displaying the first and second characters. By default, this item is set to **250msec**.

Security Option

This field allows you to limit access to the System and Setup. The default value is **Setup**. When you select *System*, the system prompts for the User Password every time you boot up. When you select *Setup*, the system always boots up and prompts for the Supervisor Password only when the Setup utility is called up.

PCI/VGA Palette Snoop

Some non-standard VGA display cards may not show colors properly. This field allows you to set whether or not MPEG ISA/VESA VGA Cards can work with PCI/VGA. When this field is enabled, a PCI/VGA can work with an MPEG ISA/VESA VGA card. When this field is disabled, a PCI/VGA cannot work with an MPEG ISA/VESA Card.

OS Select for DRAM > 64MB

This option allows the system to access greater than 64MB of DRAM memory when used with OS/2 that depends on certain BIOS calls to access memory. The default setting is **Non-OS/2**.

Report No FDD For WIN 95

This option allows Windows 95 to share with other peripherals IRQ6 which is assigned to a floppy disk drive if the drive is not existing. The default setting is **No**.

Video BIOS Shadow

This item allows you to change the Video BIOS location from ROM to RAM. Video Shadow will increase the video speed.

C8000 - CBFFF Shadow/DC000 - DFFFF Shadow

Shadowing a ROM reduces the memory available between 640KB to 1024KB. These fields determine whether or not optional ROM will be copied to RAM.

Chipset Features Setup

This Setup menu controls the configuration of the motherboard chipset.

ROM PCI/ISA BIOS CHIPSET FEATURES SETUP AWARD SOFTWARE INC.			
SDRAM RAS-to-CAS Delay	3	CPU Warning Temperature	: 66°C/151°F
SDRAM RAS Precharge Time	3	Current System Temp.	: 41°C/ 105°F
SDRAM CAS Latency Time	3	Current CPU Temp.	: 27°C/ 80°F
SDRAM Precharge Control	: Disabled	Current System Temp.	: 34°C/ 93°F
System BIOS Cacheable	: Disabled	Current CPU Fan Speed	: 2789 RPM
Video BIOS Cacheable	: Enabled	Current Chassis Fan Speed	: 2045 RPM
Video RAM Cacheable	: Disabled		
8 Bit I/O Recovery Time	: 3		
16 Bit I/O Recovery Time	: 2	VCCP (V):	1.98 V VTT (V) : 1.50 V
Memory Hole At 15MB-16MB	: Disabled	VCC3 (V):	3.45 V +5 V : 4.99 V
Passive Release	: Disabled	+12 V :	12.46 V -12 V : -12.54V
Delayed Transaction	: Disabled	-5V :	-5.21 V
AGP Aperture Size (MB)	: 64		
Auto Detect DIMM/PCI Clock	: Disabled		
Spread Spectrum	: Disabled		
CPU Host Clock (CPU/PCI)	: Default		
		ESC : Quit	↑ ↓ → ← : Select Item
		F1 : Help	PU/PD/+/- : Modify
		F5 : Old Values	(Shift) F2 : Color
		F6 : Load BIOS Defaults	
		F7 : Load Setup Defaults	

SDRAM RAS-to-CAS Delay

When DRAM is refreshed, both rows and columns are addressed separately. This field allows you to determine the timing of transition from Row Address Strobe (RAS) to Column Address Strobe (CAS). The default setting is **3**.

SDRAM RAS Precharge Time

The precharge time is the number of cycles it takes for the RAS to accumulate its charge before DRAM refresh. If insufficient time is allowed, refresh may be incomplete and the DRAM may fail to retain data. The default setting is **3**.

SDRAM CAS Latency Time

When synchronous DRAM is installed, the number of clock cycles of CAS latency depends on the DRAM timing. Do not reset this field from the default value specified by the system designer. The default value is **3**.

SDRAM Precharge Control

By default, the SDRAM Precharge Control field is set to **Disabled**.

System BIOS Cacheable

When enabled, access to the system BIOS ROM addressed at F0000H-FFFFFH is cached, provided that the cache controller is disabled.

Video BIOS Cacheable

When enabled, access to video BIOS addressed at C0000H to C7FFFH is cached, provided that the cache controller is disabled.

Video RAM Cacheable

Selecting *Enabled* allows caching of the video BIOS ROM at C0000h to C7FFFh, resulting in better video performance. However, if any program writes to this memory area, a memory access error may result.

8 Bit I/O Recovery Time

This option specifies the length of the delay (in sysclks) inserted between consecutive 8-bit I/O operations. The settings are 1, 2, 3, 4, 5, 6, 7, and 8. The default setting is 3.

16 Bit I/O Recovery Time

This option specifies the length of the delay (in sysclks) inserted between consecutive 16-bit I/O operations. The settings are 1, 2, 3, and 4. The default setting is 2.

Memory Hole at 15MB - 16MB

In order to improve performance, certain space in memory can be reserved for ISA cards. This field allows you to reserve 15MB to 16MB of memory address space to ISA expansion cards. This makes memory from 15MB and up unavailable to the system. Expansion cards can only access memory up to 16MB. By default, this field is set to *Disabled*.

Passive Release

When enabled, CPU to PCI bus accesses are allowed during passive release. Otherwise, the arbiter only accepts another PCI master access to local DRAM.

Delayed Transaction

The chipset has an embedded 32-bit posted write buffer to support delay transactions cycles. Select *Enabled* to support compliance with PCI specification version 2.1. The default setting is *Disabled*.

AGP Aperture Size (MB)

The field sets aperture size of the graphics. The aperture is a portion of the PCI memory address range dedicated for graphics memory address space. Host cycles that hit the aperture range are forwarded to the AGP without any translation. The options available are 4M, 8M, 16M, 32M, 64M, 128M and 256M. The default setting is *64M*.

Auto Detect DIMM/PCI Clk

When enabled, the system automatically shuts off clocks of unused DIMM/PCI slots. The default setting is **Disabled**. This field is for CE testing use only.

Spread Spectrum

This field sets the value of the spread spectrum. Options are Disabled, 0.25% and 0.5%. The default setting is **Disabled**. This field is for CE testing use only.

CPU Host Clock (CPU/PCI)

This field sets the value of the CPU Host Clock (CPU/PCI) The default setting is **Default**. Other options include 66/33, 75/37, 83/41, 100/33, 103/34, 112/37, 124/41, 133/44, 124/31, 133/33, 140/35, 150/37.

***NOTE:** Overclocking could cause the system not to boot. When this happens, turn off the computer by pressing the power button and turn it on again by pressing the **Insert** key and the power button simultaneously. Then press the **Delete** key to enter BIOS Setup and configure the CPU speed.*

CPU Warning Temperature

This field sets the threshold temperature at which an alert is sounded through the system's speaker. The CPU temperature is monitored by the onboard thermal sensor to prevent the CPU from overheating.

Current System Temp./ Current CPU Temp.

These read-only fields reflect the functions of the hardware thermal sensor that monitors the chip blocks and system temperatures to ensure the system is stable.

Current CPU Fan Speed/Chassis Fan Speed

These optional and read-only fields show the current speeds in RPM (revolution per minute) for the CPU fan and chassis fan as monitored by the hardware monitoring IC.

VCCP / VTT / VCC3

These optional and read-only fields show the current voltages in the voltage regulators and power supply as monitored by the hardware monitoring IC.

Power Management Setup

The Power Management Setup allows you to save energy of your system effectively. It will shut down the hard disk and turn off video display after a period of inactivity.

ROM PCI/ISA BIOS
POWER MANAGEMENT SETUP
AWARD SOFTWARE, INC.

Power Management	: User Define	** Reload Global Timer Events **	
PM Control by APM	: Yes	IRQ3 (3-7, 9-15), NMI	: Disabled
Video Off Method	: V/H SYNC +Blank	Primary IDE 0	: Enabled
Video Off After	: Standby	Primary IDE 1	: Enabled
MODEM Use IRQ	: 3	Secondary IDE 0	: Disabled
		Secondary IDE 1	: Disabled
Doze Mode	: Disabled	Floppy Disk	: Disabled
Standby Mode	: Disabled	Serial Port	: Enabled
Suspend Mode	: Disabled	Parallel Port	: Disabled
HDD Power Down	: Disabled		
Throttle Duty Cycle	: 62.5%		
PCI VGA Active Monitor	: Enabled		
Soft-Off by PWR-BTTN	: Instant-Off		
PWR On by Modem/LAN	: Disabled		
Resume by Alarm	: Disabled		
		ESC : Quit	↑ ↓ → ← : Select Item
IRQ 8 Break Suspend	: Disabled	F1 : Help	PU/PD/+/- : Modify
		F5 : Old Values	(Shift) F2 : Color
		F6 : Load BIOS Defaults	
		F7 : Load Setup Defaults	

Power Management

This field allows you to select the type of power saving management modes. There are four selections for Power Management.

Min. Power Saving	Minimum power management
Max. Power Saving	Maximum power management.
User Define	Each of the ranges is from 1 min. to 1hr. Except for HDD Power Down which ranges from 1 min. to 15 min. (Default)

NOTE: In order to enable the CPU overheat protection feature, the Power Management field should not be set to Disabled.

PM Control by APM

This field allows you to use the Advanced Power Management device to enhance the Max. Power Saving mode and stop the CPU's internal clock. If the Max. Power Saving is not enabled, this will be preset to NO.

Video Off Method

This field defines the Video Off features. There are three options.

V/H SYNC + Blank Default setting, blank the screen and turn off vertical and horizontal scanning.

DPMS Allows the BIOS to control the video display card if it supports the DPMS feature.

Blank Screen This option only writes blanks to the video buffer.

Video Off After

As the system moves from lesser to greater power-saving modes, select the mode in which you want the monitor to blank.

Modem Use IRQ

This field names the interrupt request (IRQ) line assigned to the modem (if any) on your system. Activity of the selected IRQ always awakens the system. By default, the IRQ is set to 3.

Doze Mode

When enabled, and after the set time of system inactivity, the CPU clock will run at a slower speed while all other devices still operate at full speed.

Standby Mode

After the selected period of system inactivity, the fixed disk drive and the video shut off while all other devices still operate at full speed.

Suspend Mode

When enabled, and after the set time of system inactivity, all devices except the CPU will be shut off.

HDD Power Down

When enabled, and after the set time of system inactivity, the hard disk drive will be powered down while all other devices remain active.

Throttle Duty Cycle

When the system enters Doze mode, the CPU clock runs only part of the time. You may select the percent of time that the clock runs.

PCI VGA Active Monitor

When enabled, any video activity restarts the global timer for Standby mode. The default setting is *Enabled*.

Soft-Off by PWR-BTTN

This field defines the power-off mode when using an ATX power supply. The Instant-Off mode allows powering off immediately upon pressing the power button. In the Delay 4 Sec mode, the system powers off when the power button is pressed for more than four seconds or places the system in a very low-power-usage state, with only enough circuitry receiving power to detect power button activity or Resume by Ring activity (see next field) when pressed for less than 4 seconds. The default value is *Instant-Off*.

PWR On by Modem/LAN

An input signal on the serial Ring Indicator (RI) line (in other words, an incoming call on the modem) awakens the system from a soft off state.

Resume by Alarm

This allows a computer to be turned on automatically through the timer set in the BIOS to make the system more schedulable. By default, this field is set to *Disabled*.

IRQ 8 Break Suspend

You can enable or disable the monitoring of IRQ 8 (Real Time Clock) so it does not awaken the system from Suspend mode.

Reload Global Timer Events

This section determines the reloading of the 'timers' after entering the Full On You can enable or disable the monitoring of IRQ 8 (Real Time Clock) so it does not awaken the system from Suspend mode.

PNP/PCI Configuration

This option configures the PCI bus system. All PCI bus systems on the system use INT#, thus all installed PCI cards must be set to this value.

ROM PCI/ISA BIOS PNP/PCI CONFIGURATION AWARD SOFTWARE INC.			
PNP OS Installed	: No	Used MEM base addr	: N/A
Resources Controlled by	: Manual		
Reset Configuration Data	: Disabled		
IRQ-3 assigned to	: Legacy ISA		
IRQ-4 assigned to	: Legacy ISA		
IRQ-5 assigned to	: PCI/ISA PnP		
IRQ-7 assigned to	: Legacy ISA		
IRQ-9 assigned to	: PCI/ISA PnP		
IRQ-10 assigned to	: PCI/ISA PnP		
IRQ-11 assigned to	: PCI/ISA PnP		
IRQ-12 assigned to	: PCI/ISA PnP		
IRQ-14 assigned to	: PCI/ISA PnP		
IRQ-15 assigned to	: PCI/ISA PnP		
DMA-0 assigned to	: PCI/ISA PnP		
DMA-1 assigned to	: PCI/ISA PnP	ESC : Quit	↑ ↓ ← : Select Item
DMA-3 assigned to	: PCI/ISA PnP	F1 : Help	PU/PD/+/- : Modify
DMA-5 assigned to	: PCI/ISA PnP	F5 : Old Values	(Shift) F2 : Color
DMA-6 assigned to	: PCI/ISA PnP	F6 : Load BIOS Defaults	
DMA-7 assigned to	: PCI/ISA PnP	F7 : Load Setup Defaults	

PNP OS Installed

This field allows you to specify if the operating system installed in your system is plug and play aware.

Resources Controlled by

This PnP BIOS can configure all of the boot and compatible devices automatically. However, this capability needs you to use a PnP operating system such as Windows 95. The default value is **Manual**.

Reset Configuration Data

This field allows you to determine whether or not to reset the configuration data. The default value is **Disabled**.

IRQ3/4/5/7/9/10/11/12/14/15, DMA0/1/3/5/6/7 assigned to

These fields allow you to determine the IRQ/DMA assigned to the ISA bus and is not available to any PCI slot.

Used MEM base addr

Select a base address for the memory area used by any peripheral that requires high memory. The default setting is **N/A**.

Load BIOS Defaults

This option allows you to load the troubleshooting default values permanently stored in the BIOS ROM. These default settings are non-optimal and disable all high-performance features.

ROM PCI/ISA BIOS
CMOS SETUP UTILITY
AWARD SOFTWARE, INC.

STANDARD CMOS SETUP BIOS FEATURES SETUP CHIPSET FEATURES SETUP POWER MANAGE PNP/PCI CONF LOAD BIOS DEF LOAD SETUP DEF	INTEGRATED PERIPHERALS SUPERVISOR PASSWORD USER PASSWORD DETECTION UP AVING
Load BIOS Defaults (Y/N)? N	
ESC : Quit	↑ ↓ → ← : Select Item
F10 : Save & Exit Setup	(Shift) F2 : Change Color
Load BIOS Defaults except Standard CMOS Setup	

To load BIOS defaults value to CMOS SRAM, enter “Y”. If not, enter “N”.

Load Setup Defaults

This option allows you to load the default values to your system configuration. These default settings are optimal and enable all high performance features.

ROM PCI/ISA BIOS
CMOS SETUP UTILITY
AWARD SOFTWARE, INC.

STANDARD CMOS SETUP BIOS FEATURES SETUP CHIPSET FEATURES SETUP POWER MANAGE PNP/PCI CONF LOAD BIOS DEF LOAD SETUP DEF	INTEGRATED PERIPHERALS SUPERVISOR PASSWORD USER PASSWORD DETECTION UP AVING
Load Setup Defaults (Y/N)? N	
ESC : Quit	↑ ↓ → ← : Select Item
F10 : Save & Exit Setup	(Shift) F2 : Change Color
Load BIOS Defaults except Standard CMOS Setup	

To load SETUP defaults value to CMOS SRAM, enter “Y”. If not, enter “N”.

Integrated Peripherals

This option sets your hard disk configuration, mode and port.

ROM PCI/ISA BIOS INTEGRATED PERIPHERALS AWARD SOFTWARE INC.			
IDE HDD Block Mode	: Enabled	Onboard FDC Controller	: Enabled
IDE Primary Master PIO	: Auto	Onboard Serial Port 1	: 3F8/IRQ4
IDE Primary Slave PIO	: Auto	Onboard Serial Port 2	: 2F8/IRQ3
IDE Secondary Master PIO	: Auto	UART Mode Select	: Normal
IDE Secondary Slave PIO	: Auto	Onboard Parallel Port	: 378/IRQ7
IDE Primary Master UDMA	: Auto	Parallel Port Mode	: SPP
IDE Primary Slave UDMA	: Auto		
IDE Secondary Master UDMA	: Auto		
IDE Secondary Slave UDMA	: Auto		
On-Chip Primary PCI IDE	: Enabled		
On-Chip Secondary PCI IDE	: Enabled		
USB Keyboard Support	: Disabled		
Init AGP Display First	: AGP		
		ESC : Quit	↑ ↓ ← : Select Item
		F1 : Help	PU/PD/+/- : Modify
		F5 : Old Values	(Shift) F2 : Color
		F6 : Load BIOS Defaults	
		F7 : Load Setup Defaults	

IDE HDD Block Mode

This field allows your hard disk controller to use the fast block mode to transfer data to and from your hard disk drive.

IDE Primary/Secondary Master/Slave PIO

These fields allow your system hard disk controller to work faster. Rather than have the BIOS issue a series of commands that transfer to or from the disk drive, PIO (Programmed Input/Output) allows the BIOS to communicate with the controller and CPU directly.

The system supports five modes, numbered from 0 (default) to 4, which primarily differ in timing. When Auto is selected, the BIOS will select the best available mode.

IDE Primary/Secondary Master/Slave UDMA

These fields allow your system to improve disk I/O throughput to 33Mb/sec with the Ultra DMA/33 feature. The options are *Auto* and *Disabled*.

On-Chip Primary/Secondary PCI IDE

The integrated peripheral controller contains an IDE interface with support for two IDE channels. Select *Enabled* to activate each channel separately.

USB Keyboard Support

Select *Enabled* if your system contains a Universal Serial Bus (USB) controller and you have a USB keyboard.

Init AGP Display First

This field allows the system to initialize first the VGA card in the AGP slot on the motherboard when system is turned on.

Onboard FDC Controller

Select *Enabled* if your system has a floppy disk controller (FDC) installed on the system board and you wish to use it. If you install an add-in FDC or the system has no floppy drive, select *Disabled* in this field. This option allows you to select the onboard FDD port.

Onboard Serial/Parallel Port

These fields allow you to select the onboard serial and parallel ports and their addresses. The default values for these ports are:

Serial Port 1	3F8/IRQ4
Serial Port 2	2F8/IRQ3
Parallel Port	378H/IRQ7

UART Mode Select

This field determines the UART mode in your computer. The settings are *Normal*, *IrDA* and *ASKIR*. The default value is *Normal*.

Parallel Port Mode

This field allows you to determine parallel port mode function.

SPP	Normal Printer Port
EPP	Enhanced Parallel Port
ECP	Extended Capabilities Port

Supervisor / User Password

These two options set the system password. Supervisor Password sets a password that will be used to protect the system and Setup utility. User Password sets a password that will be used exclusively on the system. To specify a password, highlight the type you want and press <Enter>. The Enter Password: message prompts on the screen. Type the password, up to eight characters in length, and press <Enter>. The system confirms your password by asking you to type it again. After setting a password, the screen automatically returns to the main screen.

To disable a password, just press the <Enter> key when you are prompted to enter the password. A message will confirm the password to be disabled. Once the password is disabled, the system will boot and you can enter Setup freely.

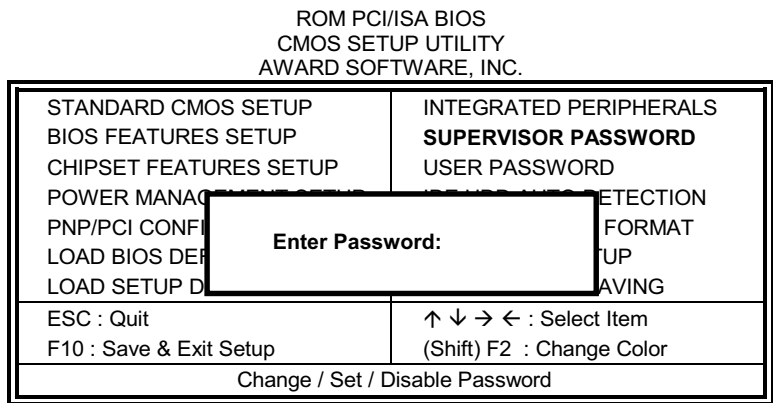

IDE HDD Auto Detection

This option detects the parameters of an IDE hard disk drive, and automatically enters them into the Standard CMOS Setup screen.

ROM PCI/ISA BIOS
STANDARD CMOS SETUP
AWARD SOFTWARE, INC.

HARD DISKS	TYPE	SIZE	CYLS	HEAD	PRECOMP	LANDZ	SECTOR	MODE
Primary Master:								
Select Primary Master Option (N=SKIP) : N								
OPTIONS	TYPE	SIZE	CYLS	HEAD	PRECOMP	LANDZ	SECTOR	MODE
1 (Y)	0	0	0	0	0	0	0	NORMAL
NOTE: Some OSes (like SCO-UNIX) must use "NORMAL" for installation								
ESC: SKIP								

Up to four IDE drives can be detected, with parameters for each appearing in sequence inside a box. To accept the displayed entries, press the "Y" key; to skip to the next drive, press the "N" key. If you accept the values, the parameters will appear listed beside the drive letter on the screen.

Save & Exit Setup

This option allows you to determine whether to accept the modifications or not. If you type “Y”, you will quit the setup utility and save all changes into the CMOS memory. If you type “N”, you will return to Setup utility.

ROM PCI/ISA BIOS
CMOS SETUP UTILITY
AWARD SOFTWARE, INC.

STANDARD CMOS SETUP	INTEGRATED PERIPHERALS
BIOS FEATURES SETUP	SUPERVISOR PASSWORD
CHIPSET FEATURES SETUP	USER PASSWORD
POWER MANAGE	DETECTION
PNP/PCI CONF	UP
LOAD BIOS DEF	AVING
LOAD SETUP DEFAULTS	
Save to CMOS and Exit (Y/N)? N	
ESC : Quit	↑ ↓ → ← : Select Item
F10 : Save & Exit Setup	(Shift) F2 : Change Color
Save Data to CMOS & Exit Setup	

Exit Without Saving

Select this option to exit the Setup utility without saving the changes you have made in this session. Typing “Y” will quit the Setup utility without saving the modifications. Typing “N” will return you to Setup utility.

ROM PCI/ISA BIOS
CMOS SETUP UTILITY
AWARD SOFTWARE, INC.

STANDARD CMOS SETUP	INTEGRATED PERIPHERALS
BIOS FEATURES SETUP	SUPERVISOR PASSWORD
CHIPSET FEATURES SETUP	USER PASSWORD
POWER MANAGE	DETECTION
PNP/PCI CONF	UP
LOAD BIOS DEF	AVING
LOAD SETUP DEFAULTS	
Quit Without Saving (Y/N)? N	
ESC : Quit	↑ ↓ → ← : Select Item
F10 : Save & Exit Setup	(Shift) F2 : Change Color
Abandon all Data & Exit Setup	

4

Intel PIIX Bus Master IDE Driver Installation

This chapter describes the installation procedure for Intel PIIX Bus Master IDE Drivers for Windows 95.

This chapter contains the following sections:

System Requirements	58
Installing the Software	59

System Requirements

This section describes system requirements for the PIIX Bus Master IDE Device Driver for Windows 95*. This driver has been designed for and tested with Windows 95 only. This driver will only install on systems with Windows 95.

1. The system must contain a supported Intel processor and chipset configuration.
2. Ensure that a mouse is connected to the system.
3. One of the following versions of Windows 95* must be installed on the system prior to running utility program.

Windows 95* 4.00.950 (Retail)

Windows 95* 4.00.950a (OSR1)

Windows 95* 4.00.950b (OSR2 without USB Supplement)

Windows 95* 4.00.950b (OSR2.1 with USB Supplement)

4. This utility should only be used on desktop systems. The utility must not be executed on notebook or portable systems with or without dock.
5. It is assumed that the BIOS properly initialized the 82371xB IDE interface for Bus Master IDE operation.
6. There is no other non-82371xB IDE controllers (add-in IDE controller or sound card with IDE) enabled on the system.

Installing the Software

This subsection describes how to install the software on a system where Windows 95 is installed.

NOTE: Record the location of the Windows 95* directory before installing the driver.

1. Check the System Requirements. Windows 95* must be fully installed and running on the system prior to running this software.
2. Close any running applications.
3. Remove references to installed real-mode IDE device drivers in the AUTOEXEC.BAT and CONFIG.SYS files (especially any drivers that control ATAPI CD-ROM and special IDE features). Use the Notepad utility to do this.

The driver files are stored in an integrated application setup program.

This program is a Windows 95* program that allows the driver files to be **INSTALLED** or **DE-INSTALLED**.

Execute the driver setup program.

Run **SETUP.EXE**.

4. Click 'Next' on Welcome Screen to read and agree to the license agreement. View the text file and choose File\Exit to close Notepad and continue. **NOTE:** If you click **No**, program will terminate.
5. Click **Yes** if you agree to continue. **NOTE:** If you click 'No', the program will terminate.
6. Select **INSTALL**, to install the PIIX Bus Master IDE Device Driver when prompted to do so.

NOTE: If the driver is currently installed on the system, SETUP will ask you whether or not you want to continue. Follow the prompts on the screen to install the driver if desired.

7. Click 'OK' to restart the system when prompted to do so.
8. Follow the screen instructions and use default settings to complete the setup when Windows 95* is re-started. Upon re-start, Windows 95* will display that it has found an Intel PCI Bus Master IDE controller hardware and is installing hardware for it.

If a **New Hardware Found** dialog box is displayed requesting the location of the drivers, use the mouse to click on the scrollbar and click on the <Windows 95* directory>\System\IOSubSys path:

For example:

Click on **C:\WINDOWS\SYSTEM\IOSUBSYS**

Click **OK**.

9. Select **Yes**, when prompted to re-start Windows 95.

NOTE: After installation, the following driver and related files are stored as listed.

<Windows 95* directory>\System\IOSubSys\IDEATAPI.MPD

<Windows 95* directory>\System\IOSubSys\PIIXVSD.VXD

<Windows 95* directory>\INF\IDEATAPI.INF

5

VGA Driver Installation

This chapter provides information on how to install the C&T 69000 VGA drivers that come in the two floppy diskettes with the package. Please follow the instructions set forth in this chapter carefully. Please note that there must be relevant software installed in your system before you could proceed to install the VGA drivers. It is recommended that you make a copy of the VGA driver diskette and put the backup copy in a safe place.

The following items are covered in this chapter:

Installing the Drivers for Windows 95.....	62
Installing the Drivers for Windows 98.....	63
Installing the Drivers for Windows NT 4.0	64

Installing the Drivers for Windows 95

The following section describes the normal display driver installation procedure for Windows 95. Use the following procedures when installing the display drivers for Windows 95.

1. Click **Start**. Select **Settings**, then click the **Control Panel** icon.
2. Double click **Display**.
3. Click **Settings**.
4. Click **Advanced Properties**.
5. Click **Change**.
6. Click **Have Disk ...**
7. Insert the diskette/CD containing the **69000 VGA driver for Windows 95** to the floppy disk drive/CD-ROM drive, then type in **A:\WIN95** (assuming drive A is your floppy disk drive) or type in **D:\VGA\C&T\WIN95** (assuming drive D is your CD-ROM drive), and press **Enter**.
8. Select **Chips and Tech. 69000 PCI/AGP**, and then click **OK**. After the files are copied, click **Close**.
9. Click **Yes** to restart your computer and for the new settings to take effect.

Installing the Drivers for Windows 98

The following section describes the normal display driver installation procedure for Windows 98. Use the following procedures when installing the display drivers for Windows 98.

1. Click **Start**. Select **Settings**, and then click the **Control Panel** icon.
2. Double click **Display**.
3. Click **Settings**.
4. Click **Advanced....**
5. Click **Adapter**.
6. Click **Change....**
7. Click **Next**.
8. Select **Display a list of all the drivers in a specific location, so you can select the driver you want**.
9. Click "**Have Disk ...**".
10. Insert the diskette/CD containing the **C&T 69000 VGA driver for Windows 98** to the floppy disk drive/CD-ROM drive, then type in **A:\WIN98** (assuming drive A is your floppy disk drive) or type in **D:\VGA\C&T\WIN98** (assuming drive D is your CD-ROM drive), and press **Enter**.
11. Select **Chips and Tech. 69000 PCI/AGP**", and click **OK**.
12. Click **Next**. After the files are copied, and click **Finish**.
13. Click **Close**.
14. Click **Close**.
15. Click **Yes** to restart your computer and for the new settings to take effect.

Installing the Drivers for Windows NT 4.0

IMPORTANT: You should install the Windows NT 4.0 Service Pack 3 first before installing the C&T 69000 VGA drivers. If you don't have the Windows NT 4.0 Service Pack 3, please contact your software vendor or download it from Microsoft's web site.

The procedures below show you how to install the C&T 69000 VGA drivers for Windows NT 4.0.

1. Boot Windows NT 4.0.
2. Double click the **My Computer** icon.
3. Double click the **Control Panel** icon.
4. Double click the **Display" icon.**
5. Click **Change Display Type.**
6. Click **Change.**
7. Click **Have Disk**, then insert the diskette/CD containing the **C&T 69000 VGA driver for Windows NT 4.0** to the floppy disk drive/CD-ROM drive, then type in **A:\WINNT40** (assuming drive A is your floppy disk drive) or type in **D:\VGA\C&T\WINNT40** (assuming drive D is your CD-ROM drive), and press **Enter.**
8. Select **Chips Video Accelerator (65545/48/50/54/55 68554 69000)**, and then click **OK.**
9. Click **Yes** to copy the drivers from the floppy disk/CD to the hard disk.
10. When copying is done, click **OK.**
11. Click **Close.**
12. Click **OK.**
13. Windows NT 4.0 will prompt you to restart computer. Click **OK** to change the Windows NT configuration.

6

LAN Driver Installation Guide

This chapter describes LAN features and driver installation of the onboard Realtek 8139A Ethernet controller.

The following items are covered in this chapter:

Introduction	66
Features	66
Software Drivers Support	66
Installing LAN Driver for Win98/Windows2000	67
Installing LAN Driver for Windows 95	68
Installing LAN Driver for Windows NT	69
Installing LAN Driver for DOS	70
Installing Driver for Windows for Workgroups	71

Introduction

Realtek 8139A is a 32-bit 10/100Mbps Ethernet controller for PCI local bus-compliant PCs. It supports the bus mastering architecture, and Auto-negotiation feature which make it possible to combine one common type of Ethernet cabling – an RJ-45 connector for twisted-pair cabling that can be used for both 10Mbps and 100Mbps connection. Extensive driver support for commonly used network operating systems is also provided.

Features

- Conforms to the Ethernet IEEE 802.3u standard
- Compatible with PCI Local Bus Revision 2.1 specification
- IEEE 802.3u Auto-Negotiation for automatic speed selection
- Supports Full-Duplex/Half-Duplex Operation
- Provides 32-bit bus mastering data transfer
- Supports 10Mbps and 100Mbps operation in a single port

Software Drivers Support

Novell network drivers:

Workstation for DOS ODI Client / OS/2 ODI Client
Server Driver for NetWare 3.11, 3.12, 4.0, 4.1X, 5.0
Client 32 for Windows 95

IBM network drivers:

LAN Server for OS/2 2.3, 4.0

Microsoft network drivers:

Microsoft Network Client for DOS, LAN Manager
Workstation/Server, Windows for Workgroups v3.11, Windows NT
3.5, 3.51 & 4.0, Windows 95 & OSR2, Windows 98 & Windows 2000

UNIX network drivers:

SCO UNIX 4.X, 5.X

Other Network Operating System Information

Packet Driver, LANtastic 6.0 with NDIS driver

The following section describes the installation driver procedure for Windows 98/Windows 2000, Windows 95, Windows NT, DOS, and Windows for Workgroup. To view the procedure of other operating systems, execute the *help8139.exe* in the diskette supplied.

Installing LAN Driver for Win98/Windows2000

This section describes the procedure to install Windows 98 and Windows 2000 driver for Realtek RTL8139 PCI Fast Ethernet adapter.

Before you start with the installation process, make sure that your adapter is properly installed in the PCI bus slot.

Executing Win98/Windows2000 will auto-detect your system configuration and find the adapter hardware. (If Win98/Windows2000 does not prompt that it detects the PCI Ethernet adapter, there must be something wrong with the Realtek RTL8139 PCI Fast Ethernet adapter or your system environment.)

1. When asked to select the driver you want to install, select "Driver from disk provided by hardware manufacturer".
2. Insert the Realtek RTL8139 driver disk into drive A and specify the setup file pathname A:\.
3. Win98/Windows2000 will appear with a message to insert Win98/Win2000 system disk to complete setup.
4. Win98/Windows2000 will finish other installation procedure automatically, and ask you to restart the system.

Installing LAN Driver for Windows 95

This section describes the procedure to install Windows 95 driver for Realtek RTL8139 PCI Fast Ethernet adapter.

Before you start with the installation process, make sure that your adapter is properly installed in the PCI bus slot. Executing Windows 95 will auto-detect your system configuration and find the adapter hardware. (If Win95 does not prompt that it detects the PCI Ethernet adapter, there must be something wrong with the RTL8139 PCI Fast Ethernet adapter or your system environment.)

1. When asked to select the driver you want to install, select "Driver from disk provided by hardware manufacturer".
2. Insert the Realtek RTL8139 driver disk into drive A and specify the setup file pathname A:\.
3. Windows 95 will appear with a message to insert Windows 95 system disk to complete setup.
5. Windows 95 will finish other installation procedure automatically, and ask you to restart the system.

Installing LAN Driver for Windows NT

This section describes the procedure to install Windows NT v3.5, v3.51 & v4.0 driver for Realtek RTL8139 PCI Fast Ethernet adapter.

When you are in Windows NT :

1. In the Main group of Windows NT, select the "Control Panel" icon.
2. In the Control Panel window, choose the "Network" icon.
3. In the Network Settings dialog box, choose the "Add Adapter" button.
The Add Network Adapter dialog box appears.
4. In the list of network cards, select "<other> Requires disk from manufacturer", and then press <Enter> button.
5. Insert the Realtek driver disk in drive A, enter drive and pathname A:\ which is the path where the setup file OEMSETUP.INF is located, and then choose the OK button.
6. The screen will appear "Select Line Speed" dialog box which is provided by RTL8139.SYS driver. The default value is "auto" so that the RTL8139 PCI Fast Ethernet adapter and its driver RTL8139.SYS will auto-detect the line speed, 10 Mb or 100Mb, while the RTL8139.SYS is loading. The other values, "10" or "100", are only used when you want to force RTL8139 PCI Fast Ethernet adapter to 10Mb or 100Mb.
7. The screen will appear "Input EthernetID" dialog box which is provided by RTL8139.SYS driver. This option is only required when you have more than one Realtek RTL8139 PCI Fast Ethernet adapters on the computer. Select "SKIP" if only one adapter installed on the computer.
8. "Bus Location" display in the next screen. Your machine contains more than one hardware bus, please select the Bus Type and Bus number on
9. NT will then perform the binding process. If any additional network software options were installed, you may be prompted for specific information for these packages.
10. Restarting your system you will require network service.

Installing LAN Driver for DOS

Before you start with the installation procedure, make sure that the adapter is properly installed and configured. Similarly, Make sure that your Microsoft Network Client is properly installed. (If not, The installation utility SETUP.EXE is located on Microsoft Network Client v3.0 for MS-DOS Disk. Run SETUP.EXE from Disk and the SETUP program screen will appear. Follow the instructions. The options are specific to your needs. The installation procedure will transfer files to a specific directory on the client and modify existing configuration files to fit your specific needs.)

1. Change to the Microsoft Network Client subdirectory, and run SETUP.EXE
2. The screen will display some information. Press <Enter>.
3. Respond to the screen prompts, selecting "Change Network Configuration", then press <Enter>.
4. Move the highlight to "Add Adapter", press <Enter>.
5. Select "Network adapter not shown on list below ...".
6. Insert the Realtek RTL8139 driver diskette in floppy A, and specify the pathname A:\NDIS2DOS, then press <Enter>.
7. Follow the screen instructions to complete the process. Simply pressing <Enter> for each screen display will select the default options. Press <Enter> until you reach the display prompting you to reboot the system.

Installing Driver for Windows for Workgroups

This section describes the procedure to install Microsoft Windows for Workgroups v3.11 driver for REALTEK RTL8139 Fast Ethernet adapter.

1. When installing Windows for Workgroups, you are prompted for a network driver. Select the "Unlisted or Updated Network Driver".
2. Insert the REALTEK adapter driver disk containing OEMSETUP.INF and RTSND.DOS files.
3. Specify the directory for the driver (A:\WFW311) and select the Adapter driver.
4. Select Advanced options, and make sure the parameters match the card settings. Check keyword "EtherID", which is provided by RTSND.DOS. The installation program copies the necessary files and creates PROTOCOL.INI for use with the adapter.

Existing Windows for Workgroups Installation:

1. Select the "Network Setup" icon in the Network Group.
2. Select the "Driver.." button.
3. Select the "Add Adapters.." button.
4. Select "Unlisted or Updated Network Adapter"
5. Insert the adapter driver disk with OEMSETUP.INF and RTSND.DOS and specify the path A:\WFW311.
6. Select the REALTEK adapter driver.
7. The installation program copies the necessary files and creates PROTOCOL.INI for use with the adapter.
8. Select "Close" and when prompted, restart the computer for changes to take affect and complete the installation.

NOTE: You must have a terminated cable attached to the adapter when you start Windows for Workgroups. If you don't, Windows for Workgroups hangs.

This page was intentionally left blank.

7

System Monitor Utility

This chapter introduces System Monitor Utility that comes with the CPU card in conjunction with the onboard hardware monitoring IC. The sections in the following pages describe the functions of the utility.

System Monitor is utility software that oversees the general performance of systems, covering areas like system temperature, system voltage, CPU and system fan rotational speeds. If conditions become adverse, that is, when voltages are erratic or CPU temperature exceeds the safe limits, an alarm will be sounded; thereby preventing system crashing and ensuring overall stability.

NOTE: System Monitor currently supports English and Chinese under Windows 95/98 and Windows NT. English will be used for other language environments.

When System Monitor is initiated, the icon below appears in the task bar in the Windows environment.



The following screen appears upon clicking on the System Monitor icon.

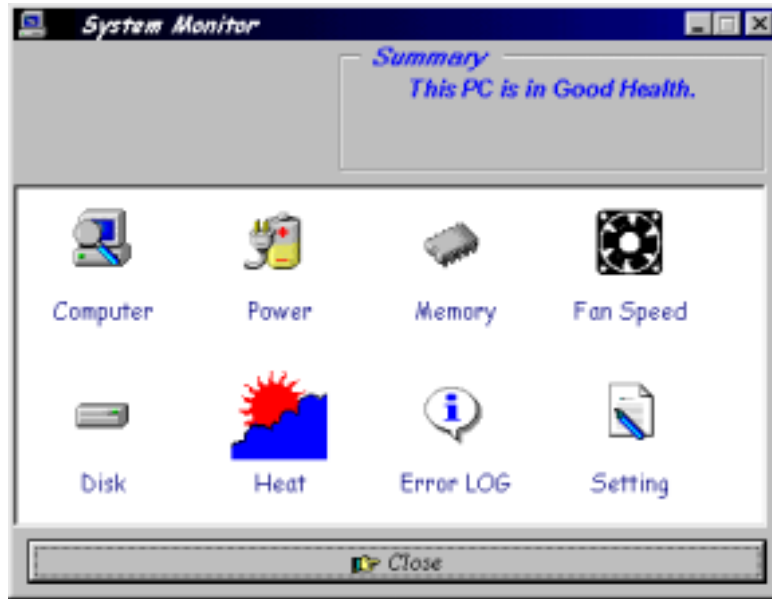

Clicking on the upper left corner button would show you the latest company information. "Summary" provides the current system status.

The section below describes the different functions of System Monitor.

1. Computer - displays the current working system version and processor type.

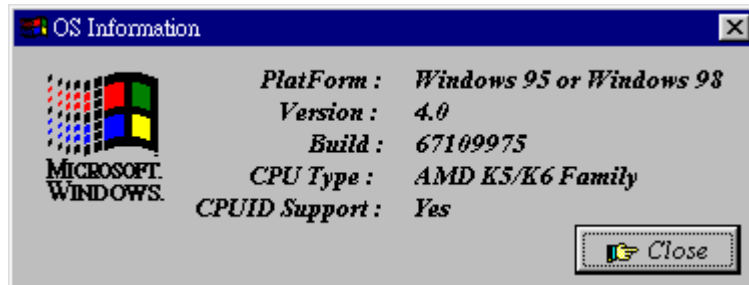

2. Power - displays the current voltage status.

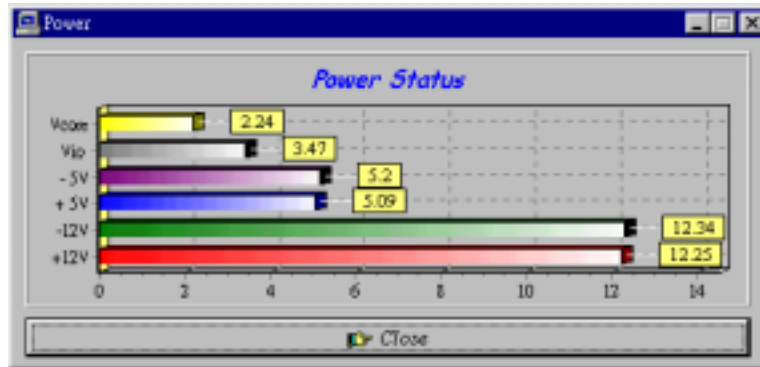

3. Memory - displays the current memory usage status.

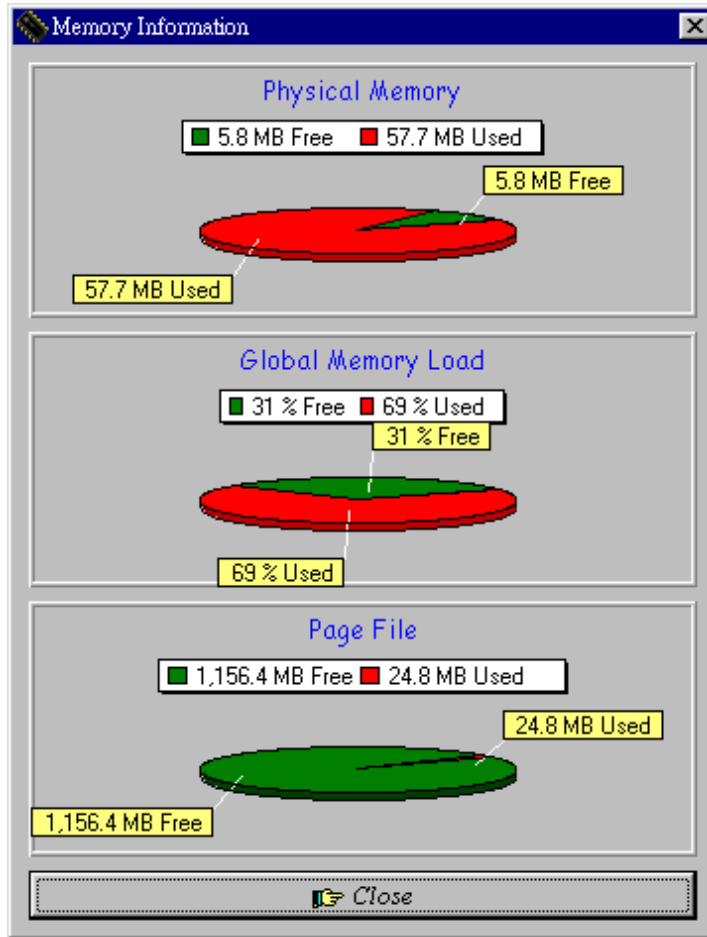

- Fan Speed - displays the current rotational speeds of CPU and chassis fans.

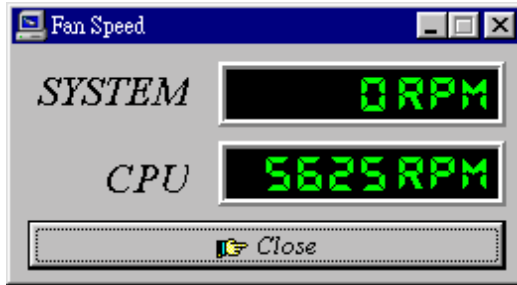

- Disk - displays the supported disk formats and disk space.

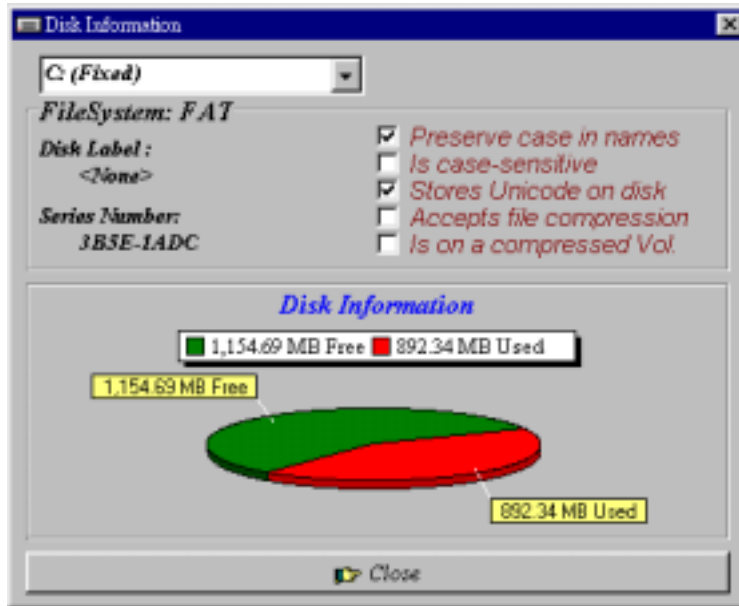

- Heat - displays the CPU and system temperatures.

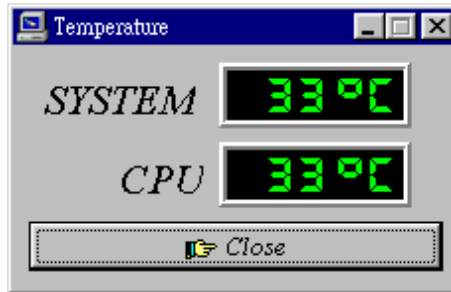

- Error Log - displays errors occurring after System Monitor is started.

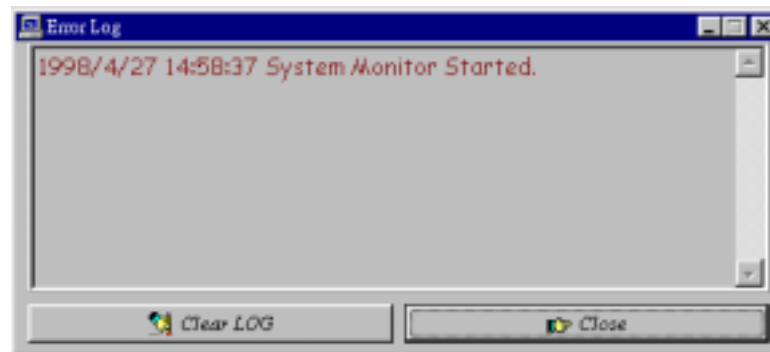

8. Setting - sets the values at which an alarm is sounded.

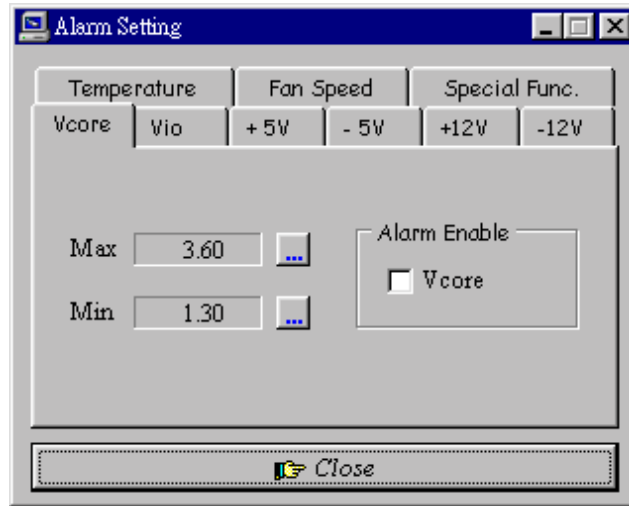

Voltage : the acceptable voltage range between the "MAX" and "MIN" value.

Temperature : temperature threshold.

Fan Rotation Speed : the minimum rotation speed.

NOTE: Intel has defined a margin of difference for the voltages as below:

12 Volts - 10% (10.8V ~ 13.2V)

5 Volts - 5% (4.75 ~ 5.25%)

Vio - 5% (Vio for P54C CPU is 3.5V. Vio for P55C is 3.3V.)

Vcore- 5%

8

LDCM Utility

This chapter gives a brief introduction to the optional LANDesk® Client Manager (LDCM) utility, as well as the installation procedures.

The following items are covered in this chapter:

Introduction	82
Installation	83
Installing the Local Version of LDCM.....	84
Installing the Administrative Version of LDCM	86

Introduction

LANdesk Client Manager (LDCM 3.1) provides the capability for managing components (network interface cards, memory, printers, software applications, etc.) within a PC system. It uses the Desktop Management Interface (DMI) standard established by the Desktop Management Task Force (DMTF). Manageable components can be viewed, monitored, and administrated across multiple platforms, either locally or remotely on a network.

The LDCM package has been implemented in two different ways: a user (client/local) version and an administrative version (Remote Companion). The user version provides the ability to only manage the local PC. The administrative version allows a network administrator to manage the local PC and other PC nodes on the network. This means that the administrative version has the ability to gather information about remote PCs, as well as remotely controlling the PCs. The remote access is based upon granted rights by the managed client.

LDCM provides the user with self-help diagnostics, including a PC health meter, local alerting of potential problems, and hardware and software inventory. Automatic polling and alerting of memory and hardware conditions and predictive failure mechanisms minimize downtime and increase effective troubleshooting. LDCM can take periodic "snapshots" of critical configuration files for easy change management and restoration when needed.

To use LDCM, your computer must meet the following requirements:

- Operating System: Windows 95, Windows NT 3.51, or Windows NT4.0
- Memory: about 200KB
- Disk Storage Space: 3-5MB
- Hardware System: a DMI BIOS is required for full LDCM functionality

For network computers, the following requirements also apply:

- Protocols: IPX or IP (WinSock-enabled) communication protocol loaded on the client
- Hardware Interfaces: a network card for communication on the network

Installation

The optional LANDesk utility that comes with the CPU card runs in Windows NT or Windows 95 operating system.

Upon entering the Windows NT 4.0 or Windows 95 environment, insert the CD. Windows will autorun the installation program and show the following screen.

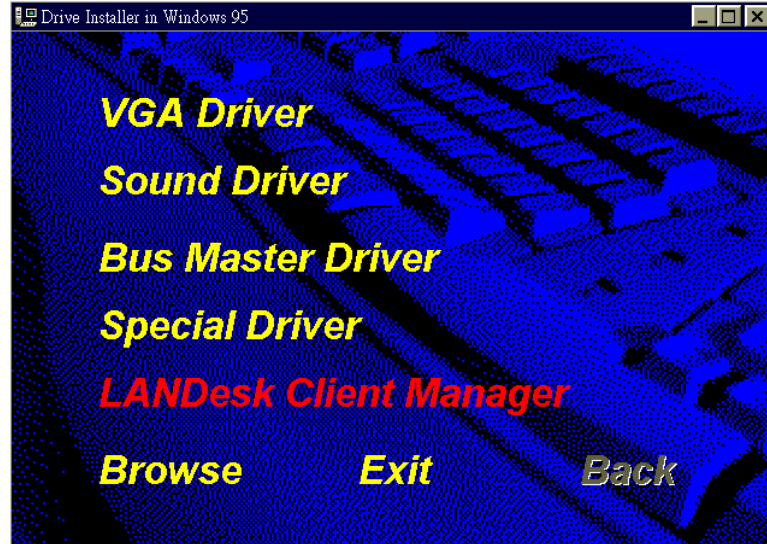

NOTE: During Setup, you will be asked to install Internet Explorer 3.02 in order to continue, or else Setup will be aborted. LDCM supports various languages and will default to English if it is unable to load 'language.dl'..

Installing the Local Version of LDCM

Double Click on 'LANdesk Client Manager' in the initial screen and the following screen will appear. Double click on the local version of LANdesk Client Manager.



When the Welcome screen appears, click on "Next" to continue with Setup.

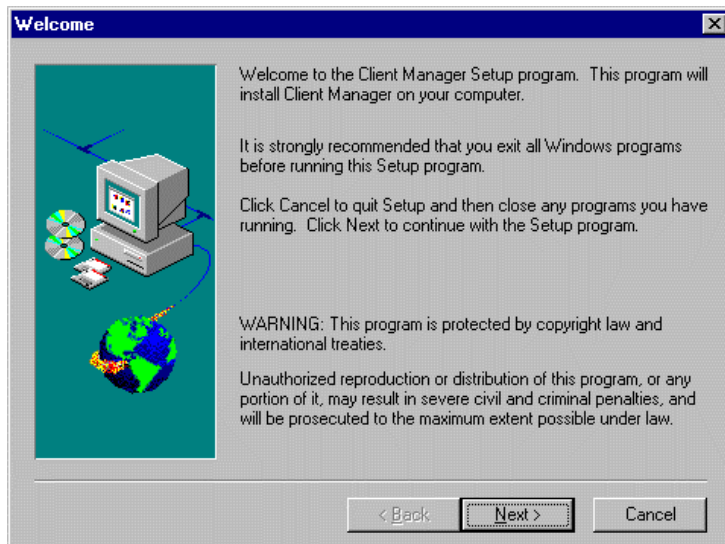

Choose the directory location where Setup will install LANdesk Client Manager. Click “Browse” if you want to change the directory suggested. Otherwise, click “Next” to start installing LDCM.

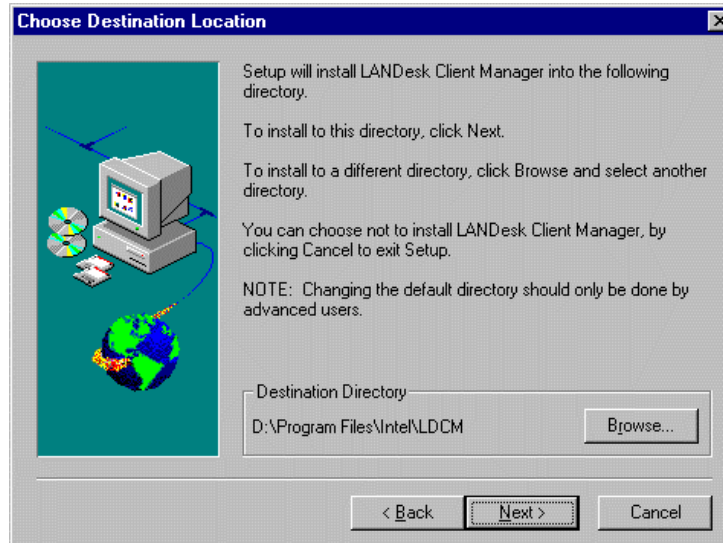

When Setup is finished, changes will have been made to the file AUTOEXEC.BAT. Restart your computer for the changes to take effect.

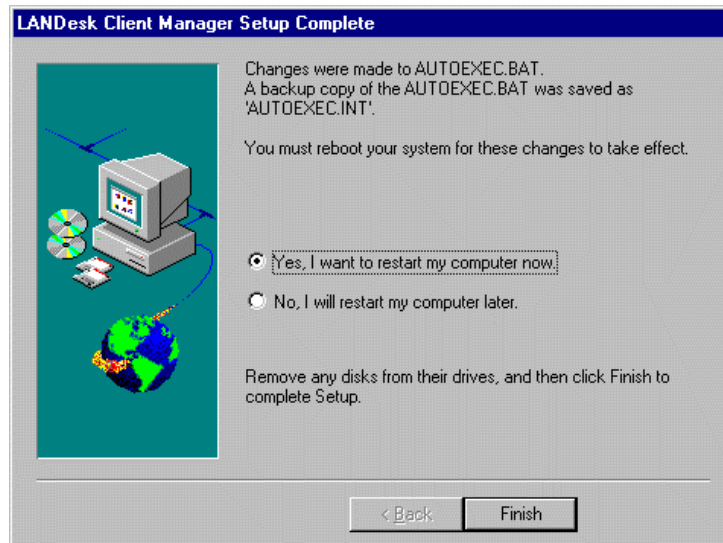

Installing the Administrative Version of LDCM

After double clicking on 'LANdesk Client Manager' in the initial screen, select the administrative version of the LDCM and the Welcome screen below will appear. Click on "Next" to continue.

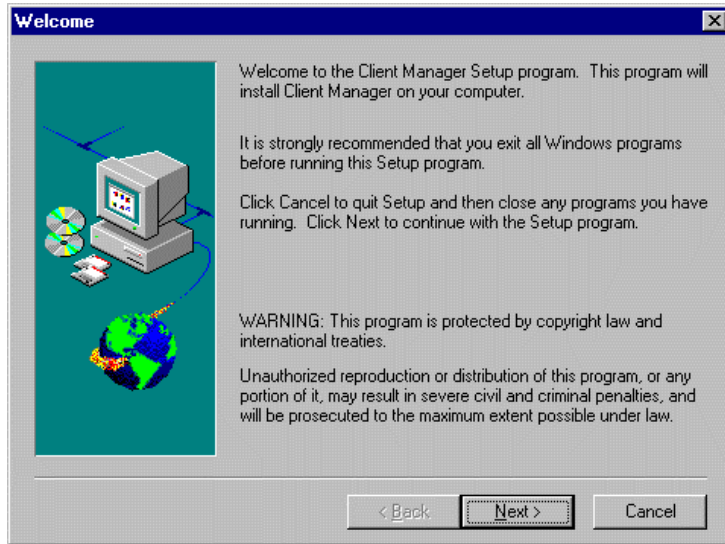

The screen below allows you to install the documentation in Adobe Acrobat format and the Adobe Acrobat Reader software. Select the options you need and click on "Next" to start the installation.

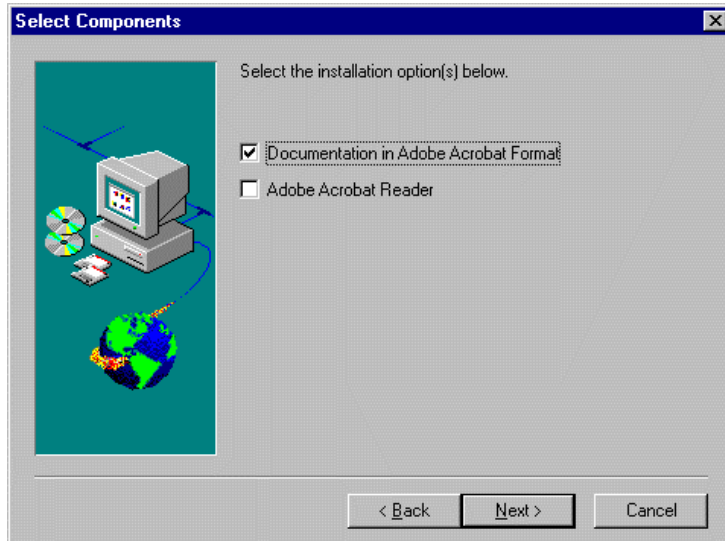

After LANdesk Client Manager Setup is complete, restart your computer to be able to use the LANdesk Client Manager.

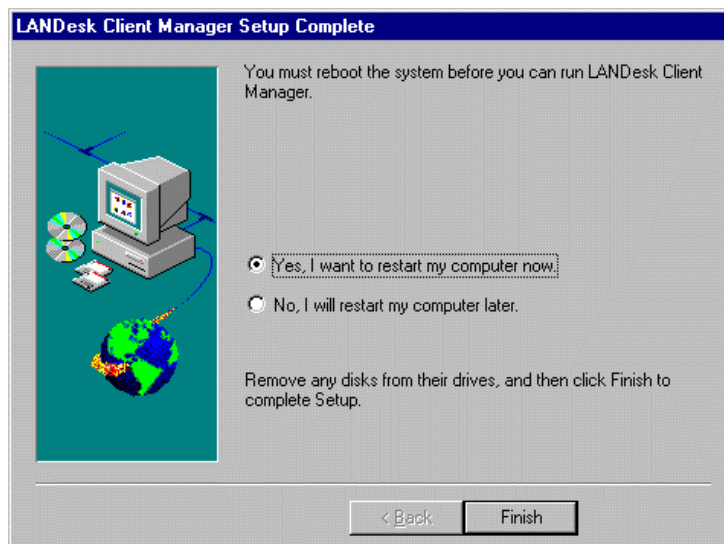

This page was intentionally left blank.

9

SCSI Installation Guide

This chapter serves as an installation guide to the onboard SCSI interface on your CPU card. It contains important information to ease the installation and configuration process.

With the SCSI interface, you can connect SCSI peripherals such as hard disk drives, scanners, CD-ROM drives and tape drives.

Topics covered in this chapter include:

Installing SCSI Driver for DOS.....	90
Installing SCSI Driver for Windows 95/98	91
Files you need:.....	91
Installation:.....	91
Driver Installation for Windows-NT	93
Installing SCSI driver for OS/2 3.X & 4.X.....	95

Installing SCSI Driver for DOS

The DOSSETUP.EXE program installs the 16bit ASPI drivers, SCSI CD-ROM driver and the Microsoft CD extensions. This program will automatically create or modify the AUTOEXEC.BAT and CONFIG.SYS files on your hard drive. To complete CD-ROM installation, you will need MSCDEX.EXE pre-installed on the hard drive or on a floppy disk. MSCDEX.EXE is on MS-DOS 6.2x Setup Disk Number One. Be sure that you know the location and the path of MSCDEX.EXE prior to running DOSSETUP.EXE. The hard drive will need MS-DOS 6.xx installed or it will need to be formatted with the /s option (i.e. - bootable format) prior to running Initio DOSSETUP.EXE. From the x:\DOS prompt type "DOSSETUP" and press "enter". NOTE: x = drive letter of floppy drive used. After DOSSETUP.EXE completes, be sure to reboot system so changes take effect.

Installing SCSI Driver for Windows 95/98

Files you need:

Information script files for installation: INIA100.INF.
Miniport device driver: INIA100.MPD.

Installation:

- A: New Windows 95 installation:
- B. Adding INI-A100U2W to an existing Windows 95/98:
- C. Updating device driver:

A: New Windows 95/98 installation:

1. Run SETUP.EXE from the Windows 95/98 CD-ROM and follow the directions on the screen.
2. After a Windows 95/98 session is established, select "My Computer/Control Panel/System/Device Manager/Other devices/PCI SCSI Bus Controller" from the Windows 95/98 desktop.
3. Click the "Driver" tab, then click the "Change Driver" tab.
4. Double click "SCSI controllers", then click the "Have Disk" button.
5. At the prompt, type in "A:\win95", insert Initio INI-A100U2W driver disk 1, and click the "OK" button.
6. Select "Initio INI-A100U2W Host Adapter", click the "OK" button. Windows 95 will copy INIA100.MPD to your hard disk. Reboot to complete the driver installation.

B. Adding INI-A100U2W to an existing Windows 95:

1. Install the Initio hardware as described in the User Manual/User Guide. Windows 95 will detect the presence of a new hardware.
2. When Windows 95 displays the following:

New Hardware Found
PCI SCSI Bus Controller
Select which driver you want to install for your new hardware:
* Driver from disk provided by hardware manufacture
OK Cancel Help

Click "OK".

3. Windows 95 will then display the following:

Install From Disk Insert the manufacturer's installation disk into the drive selected, and then click OK Copy manufacturer's files from A:\WIN95
--

Insert the Initio disk 1 into drive A: and Click "OK".

Windows 95 will interpret INIA100.INF script files and load INIA100.MPD driver to win95/system/iosubsys directory.

4. Windows 95 will then display the following:

System Settings Changed To finish setting up your new hardware, you must restart your computer. Do you want to restart your computer now? Yes No

Remove the diskette from drive A: and Click "Yes".

C. Updating device driver:

1. From the Windows 95 desktop, select "My Computer/Control Panel/System/Device Manager/SCSI Controller/Initio INI-A100U2W Host Adapter".
2. Click "Driver" tab, and then click "Change Driver" tab.
3. Type "A:\win95" and insert Initio INI-A100U2W driver disk into floppy drive A:, click "OK", Windows 95 will copy the new device driver into the hard disk.

Driver Installation for Windows-NT

Files you need:

Script files for installation: txtsetup.oem, oemsetup.inf, disk1.
Device driver: INIA100.SYS

Installation:

A: Install Windows-NT on a hard drive from the INI-A100U2W SCSI Host adapter.

1. If you are installing Windows-NT from a floppy drive, locate the Windows-NT Disk 1 for floppy Installation. Make a backup copy of this diskette.
2. If you are installing Windows-NT from a CD-ROM drive, locate the, Windows-NT Setup Disk for CD-ROM Installation. Make a backup copy of this diskette.
3. Put the disk into drive A and turn on your computer.
4. Follow the instructions, and select "CUSTOM SETUP".
5. Select "OTHER" from the list of "Additional SCSI Adapters". A message will appear on the screen stating that, "Requires disk provided by a hardware manufacturer". Insert the diskette containing INI-A100U2W device driver and press ENTER.
6. Windows-NT will interpret the txtsetup.oem and oemsetup.inf script files and load INIA100.SYS driver to xxx/system32/drivers directory.

B: Adding or updating the Initio driver to an existing Windows-NT 4.0 booted from IDE drive or different type of host adapter:

1. Establish a Windows-NT session.
 - Select CONTROL PANEL from within the MY COMPUTER group.
 - Select SCSI ADAPTERS from within the CONTROL PANEL group.
2. Select the DRIVERS tab from within the SCSI ADAPTERS group:
 - In the DRIVERS window, select "ADD...".
3. In the INSTALL DRIVER window, select "HAVE DISK...".
4. In the INSTALL FROM DISK window that is displayed, enter the Initio Driver path name:
 - Insert INI-A100U2W Driver Disk 1 into drive A:
 - Type: A:\WINNT, select "OK"

5. Select INITIO INI-A100U2W Host Adapter, select "OK" to install the INIA100.SYS driver onto your hard disk drive.
6. In the WINDOWS NT SETUP window that is displayed, enter the Initio Driver path name to continue:
 - Type:A:\WINNT, select "CONTINUE"
7. This completes updating the Host Adapter Driver. Follow the on-screen directions to restart your computer and activate the new driver.
8. It is highly recommended that you verify your Windows NT device driver has been properly installed by selecting MY COMPUTER from the desktop. Then select CONTROL PANEL:
 - Select SCSI ADAPTERS from within the CONTROL PANEL group
 - Highlight INITIO INI-A100U2W SCSI HOST ADAPTER from within the SCSI ADAPTERS listing, and select PROPERTIES. If "This device is working properly" is displayed in the Device status box, the driver has been correctly installed.

C: Floppyless SETUP

If you are running WINNT.EXE or WINNT32.EXE to install or upgrade Windows NT, when system reboot and screen turn black with the text "Setup is inspecting your computer's hardware configuration...", You have two seconds to press 'F6' key to enter the DRIVER INSTALL SCREEN, this is the time to insert Initio Windows NT installation diskette, and type "A:\WINNT" to load the INI-A100U2W Windows NT driver.

Installing SCSI driver for OS/2 3.X & 4.X

I) Installation procedures for INI-A100u2W OS/2 3.X & 4.X device driver:

A) Installed as a secondary controller

- 1) Open the OS/2 System Folder.
- 2) Open the System Setup Folder.
- 3) Double-click "Device Driver Install".
- 4) Insert the Initio installation diskette into your floppy drive.
- 5) Change to the OS/2 directory.
- 6) Choose INIA100.ADD, then click INSTALL.
- 7) After installation is done, OS/2 will report the status.

B) Installed as a primary controller

- 1) Make backup copies of the OS/2 Diskette 1.
- 2) Copy the INIA100.ADD onto OS/2 Diskette 1.
- 3) Modify the config.sys file on Diskette 1 to add
BASEDEV=INIA100.ADD /V
- 4) Install OS/2 using the backup Diskette 1

II) Driver configuration options:

- /V Verbose mode provides detail information about driver when driver is initialized
- /!V Non Verbose mode (default)
- /ET Driver assumes that all targets have more than one LUN (default)
- /!ET Driver assumes that all targets only have LUN 0
- /Q:x Specifies maximum number of tag commands per target
- /!Q No tag command
- /B:(d,dd),. Scan devices only on PCI BUS d, DEVICE dd
- /B:d Scan all the devices on the PCI BUS d
- /T:xxxx Target enable mask WORD (Default scan all targets)

- /A:d Adapter IDs are assigned based on BIOS address and then PCI device address
- /DM:d,.. Enable direct access storage device (DASD) support on target d
- /!DM:d,.. Disable DASD manager support on target d
- /SM:d,.. Enable SCSI manager support on target d
- /!SM:d,.. Disable SCSI manager support on target d

Appendix

- A. I/O Port Address Map**
- B. Interrupt Request Lines (IRQ)**

A. I/O Port Address Map

Each peripheral device in the system is assigned a set of I/O port addresses, which also becomes the identity of the device. There is a total of 1K port address space available. The following table lists the I/O port addresses used on the Industrial CPU Card.

Address	Device Description
000h - 01Fh	DMA Controller #1
020h - 03Fh	Interrupt Controller #1
040h - 05Fh	Timer
060h - 06Fh	Keyboard Controller
070h - 07Fh	Real Time Clock, NMI
080h - 09Fh	DMA Page Register
0A0h - 0BFh	Interrupt Controller #2
0C0h - 0DFh	DMA Controller #2
0F0h	Clear Math Coprocessor Busy Signal
0F1h	Reset Math Coprocessor
1F0h - 1F7h	IDE Interface
278 - 27F	Parallel Port #2(LPT2)
2F8h - 2FFh	Serial Port #2(COM2)
2B0 - 2DF	Graphics adapter Controller
378h - 3FFh	Parallel Port #1(LPT1)
360 - 36F	Network Ports
3B0 - 3BF	Monochrome & Printer adapter
3C0 - 3CF	EGA adapter
3D0 - 3DF	CGA adapter
3F0h - 3F7h	Floppy Disk Controller
3F8h - 3FFh	Serial Port #1(COM1)

B. Interrupt Request Lines (IRQ)

There are a total of 15 IRQ lines available on the Industrial CPU Card. Peripheral devices use interrupt request lines to notify CPU for the service required. The following table shows the IRQ used by the devices on the Industrial CPU Card.

Level	Function
IRQ0	System Timer Output
IRQ1	Keyboard
IRQ2	Interrupt Cascade
IRQ3	Serial Port #2
IRQ4	Serial Port #1
IRQ5	Parallel Port #2
IRQ6	Floppy Disk Controller
IRQ7	Parallel Port #1
IRQ8	Real Time Clock
IRQ9	Software Redirected to Int 0Ah
IRQ10	Reserved
IRQ11	Reserved
IRQ12	Reserved
IRQ13	80287
IRQ14	Primary IDE
IRQ15	Secondary IDE