

AK73 Pro Online Manual

DOC. NO.: AK73P-OL-E0009A



What's in this manual

AK73 Pro	1
<i>What's in this manual</i>	2
<i>You Must Notice</i>	10
<i>Before You Start</i>	11
<i>Overview</i>	12
<i>Feature Highlight</i>	13
<i>Quick Installation Procedure</i>	18
<i>Motherboard Map</i>	19
<i>Block Diagram</i>	20
Hardware Installation	21
<i>JP14 Clear CMOS</i>	22
<i>CPU Installation</i>	23
<i>FSB/PCI Clock & Ratio</i>	24
<i>CPU Jumper-less Design</i>	26
<i>CPU and Housing Fan Connector (With H/W Monitoring)</i>	28

<i>DIMM Socket</i>	29
<i>3.3V Main Power Adjustable</i>	31
<i>3.3V RAM Power LED</i>	32
<i>Front Panel Connector</i>	33
<i>ATX Power Connector</i>	35
<i>AC Power Auto Recovery</i>	36
<i>IDE and Floppy Connector</i>	37
<i>IrDA Connector</i>	40
<i>WOM (Zero Voltage Wake on Modem)</i>	41
<i>WOL (Wake on LAN)</i>	44
<i>AGP (Accelerated Graphic Port)</i>	46
<i>AMR (Audio/Modem Riser)</i>	47
<i>PC99 Color Coded Back Panel</i>	48
<i>Support 2nd USB Port</i>	49
<i>JP12 Enable/Disable Onboard Sound</i>	50
<i>CD Audio Connector</i>	51

<i>Modem Audio Connector</i>	52
<i>Video-Audio-IN Connector</i>	53
<i>Front Panel Audio (Optional)</i>	54
<i>Battery-less and Long Life Design</i>	55
<i>Over-current Protection</i>	56
<i>Hardware Monitoring</i>	58
<i>Resettable Fuse</i>	59
<i>JP30 Die-Hard BIOS (100% Virus Protection)</i>	60
<i>GPO (General Purpose Output) Connector</i>	63
<i>Dr. LED Connector (Optional)</i>	64
<i>Dr. Voice (Optional)</i>	66
<i>Year 2000 (Y2K)</i>	67
<i>Low ESR Capacitor</i>	69
<i>Layout (Frequency Isolation Wall)</i>	71
<i>24K Gold Heatsink</i>	72
<i>Driver and Utility</i>	73

<i>Autorun Menu from Bonus CD Disc</i>	74
<i>Installing Windows 95</i>	75
<i>Installing Windows 98</i>	76
<i>Installing Windows 98 SE, Windows ME & Windows2000</i>	77
<i>Installing VIA 4 in 1 Driver</i>	78
<i>Installing Onboard Sound Driver</i>	79
<i>Installing Hardware Monitoring Utility</i>	80
<i>ACPI Suspend to Hard Drive</i>	81
<i>ACPI Suspend to RAM (STR)</i>	88
AWARD BIOS	90
<i>Enter BIOS Setup</i>	91
<i>Change Language</i>	92
<i>Standard CMOS Features</i>	93
<i>Advanced BIOS Features Setup</i>	99
<i>Advanced Chipset Features Setup</i>	107
<i>Integrated Peripherals</i>	117

<i>Power Management Setup</i>	132
<i>PNP/PCI Configuration Setup</i>	146
<i>PC Health Status</i>	152
<i>Frequency/Voltage Control</i>	153
<i>Load Setup Defaults</i>	156
<i>Load Turbo Defaults</i>	157
<i>Set Password</i>	158
<i>Save & Exit Setup</i>	159
<i>Exit without Saving</i>	160
<i>Load EEPROM Default</i>	161
<i>Save EEPROM Default</i>	162
<i>BIOS Upgrade</i>	163
<i>Overclocking</i>	165
<i>VGA Card & Hard Disk</i>	167
<i>Glossary</i>	168
<i>AC97</i>	168

<i>ACPI (Advanced Configuration & Power Interface)</i>	168
<i>AGP (Accelerated Graphic Port)</i>	169
<i>AMR (Audio/Modem Riser)</i>	169
<i>AOpen Bonus Pack CD</i>	169
<i>APM</i>	170
<i>ATA/66</i>	170
<i>ATA/100</i>	170
<i>BIOS (Basic Input/Output System)</i>	171
<i>Bus Master IDE (DMA mode)</i>	171
<i>CODEC (Coding and Decoding)</i>	171
<i>DIMM (Dual In Line Memory Module)</i>	172
<i>ECC (Error Checking and Correction)</i>	172
<i>EDO (Extended Data Output) Memory</i>	172
<i>EEPROM (Electronic Erasable Programmable ROM)</i>	173
<i>EPROM (Erasable Programmable ROM)</i>	173
<i>EV6 Bus</i>	173

<i>FCC DoC (Declaration of Conformity)</i>	174
<i>FC-PGA</i>	174
<i>Flash ROM</i>	174
<i>FSB (Front Side Bus) Clock</i>	175
<i>I²C Bus</i>	175
<i>P1394</i>	175
<i>Parity Bit</i>	175
<i>PBSRAM (Pipelined Burst SRAM)</i>	176
<i>PC100 DIMM</i>	176
<i>PC133 DIMM</i>	176
<i>PDF Format</i>	176
<i>PnP (Plug and Play)</i>	177
<i>POST (Power-On Self Test)</i>	177
<i>RDRAM (Rambus DRAM)</i>	177
<i>RIMM</i>	178
<i>SDRAM (Synchronous DRAM)</i>	178

<i>Shadow E²PROM</i>	178
<i>SIMM (Single In Line Memory Module)</i>	179
<i>SMBus (System Management Bus)</i>	179
<i>SPD (Serial Presence Detect)</i>	179
<i>Ultra DMA/33</i>	180
<i>USB (Universal Serial Bus)</i>	180
<i>VCM (Virtual Channel Memory)</i>	180
<i>ZIP file</i>	181
Troubleshooting.....	182
Technical Support	186
Product Registration	190

You Must Notice



Adobe, the Adobe logo, Acrobat is trademarks of Adobe Systems Incorporated.

AMD, the AMD logo, Athlon and Duron are trademarks of Advanced Micro Devices, Inc.

Intel, the Intel logo, Intel Celeron, PentiumII, Pentium!!! are trademarks of Intel Corporation.

Microsoft, Windows, and Windows logo are either registered trademarks or trademarks of Microsoft Corporation in the United States and/or other countries.

All product and brand names used on this manual are used for identification purposes only and may be the registered trademarks of their respective owners.

All of the specifications and information contained in this manual are subject to change without notice. AOpen reserves the right to revise this publication and to make reasonable changes. AOpen assumes no responsibility for any errors or inaccuracies that may appear in this manual, including the products and software described in it.

This documentation is protected by copyright law. All rights are reserved.

No part of this document may be used or reproduced in any form or by any means, or stored in a database or retrieval system without prior written permission from AOpen Corporation.

Copyright® 1996-2000, AOpen Inc. All Rights Reserved.



Before You Start



This Online Manual will introduce to the user how this product is installed. All useful information will be described in later chapters. Please keep this manual carefully for future upgrades or system configuration changes. This Online Manual is saved in [PDF format](#), we recommend using Adobe Acrobat Reader 4.0 for online viewing, it is included in [Bonus CD disc](#) or you can get free download from [Adobe web site](#).

Although this Online Manual is optimized for screen viewing, it is still capable for hardcopy printing, you can print it by A4 paper size and set 2 pages per A4 sheet on your printer. To do so, choose **File > Page Setup** and follow the instruction of your printer driver.

Thanks for the help of saving our earth.

Overview

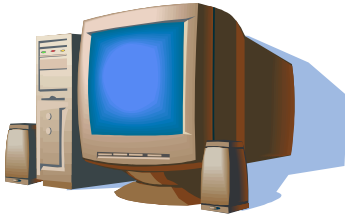

Thank you for choosing AOpen AK73 Pro. The AK73 Pro is AMD® Socket 462 motherboard (M/B) based on the ATX form factor featuring the [VIA Apollo KT133 chipset](#). As high performance chipset built in the M/B, the AK73 Pro can support AMD® Socket 462 series Athlon™ & Duron™ processor and 200MHz ([EV6](#)) system bus. In the AGP performance, it has one AGP Pro slot (optional) and supports AGP 1X/2X/4X mode and pipelined spilt-transaction long burst transfer up to 1066MB/sec. According to different customer's requirements, [SDRAM](#), [VCM \(Virtual Channel Memory\)](#) and [PC-100](#) Registered DRAM can be applied to the AK73 Pro and the maximum memory size can be up to 1.5GB. The on-board IDE controller supports [Ultra DMA 33/66/100](#) mode and the transfer rate up to 100MB/s. Besides, the on-board [AC97 CODEC](#) chip with SoundMax 2.0 provides high performance and magic surround stereo sound to let people enjoy working with AK73 Pro. Now, enjoy all features from AOpen AK73 Pro.

Feature Highlight

CPU

Supports AMD® Socket 462 Athlon® & Duron® 600MHz~1GHz+ with 200MHz EV6 system bus designed for Socket 462 technology.

Chipset

The VIA Apollo KT133 chipset incorporated as a north bridge is in charge of the host bus interface and memory bus control. The memory bus control supports two and four way interleaved of PC-100 and PC-133 SDRAM registered* DIMM and VCM up to 1.5GB. The north bridge provides one 32bit PCI bus running at 33MHz and another secondary PCI bus running at 33/66MHz. (*The VIA Apollo KT133 chipset only support PC-100 registered DIMM module.)

Memory

The three 168-pin DIMM system memory sockets that support up to 1.5GB of PC-100/133 compliant [SDRAM](#) (Synchronous Dynamic Random Access Memory), [VCM](#) (Virtual Channel Memory) and PC-100 Registered DIMMs. You can install 32, 64, 128, 256 and 512MB SDRAM DIMM module into each socket.



Expansion Slots

Including five 32-bit/33MHz, one AMR and one AGP (AGP Pro slot is optional) slots. The PCI local bus throughput can be up to 132MB/s. The [AMR \(Audio/Modem Riser\)](#) slot provided from AK73 Pro can support AMR interface for a Modem card. The Intel® AGP Pro rev. 1.0 specification provides a new level of video display sophistication and speed. The AGP Pro video cards support data transfer rates up to 1066MB/s. As AK73 Pro include one AGP Pro expansion slot for a bus mastering AGP graphics card. For AD and SBA signaling, AK73 Pro can supports 133MHz 2X/4X mode.

Ultra DMA 33/66/100 Bus Master IDE

Comes with an on-board PCI Bus Master IDE controller with two connectors that supports four IDE devices in two channels, supports Ultra DMA 33/66/100, PIO Modes 3 and 4 and Bus Master IDE DMA Mode 4, and supports Enhanced IDE devices.

CPU Vcore & Ratio Adjustment

Providing CPU Vcore and ratio adjustment function that makes your CPU get maximum performance and system reliability when you overclocking. You can select the CPU ration from 5 to 12.5 by DIP switch, and adjust the CPU Vcore value in the BIOS setup program.

On-board AC97 Sound

AK73 Pro uses the AD1885 AC97 sound chip. This on-board audio includes a complete audio recording and playback system.

Die-Hard BIOS with external controller (Optional)

The Die-Hard BIOS technology is a very effective hardware protection method that doesn't involve any software or BIOS coding. Hence, it is 100% virus free.

Dr. LED (Optional)

The Dr. LED has 8 LEDs on the AK73 Pro and can easily show what kind of problem you may encounter.

Dr. Voice (Optional)

The Dr. Voice provides 4 kinds of language version (English, Chinese, Japanese and German) that can easily tell what kind of problem you may encounter.



Power Management/Plug and Play

The AK73 Pro supports the power management function that conforms to the power-saving standards of the U.S. Environmental Protection Agency (EPA) Energy Star program. It also offers Plug-and-Play, which helps save users from configuration problems, thus making to system user-friendlier.

Hardware Monitoring Management

Supports CPU or system fans status, temperature and voltage monitoring and alert, through the on-board hardware monitor module and [Aopen Hardware Monitoring Utility](#).

Enhanced ACPI

Fully implement the [ACPI](#) standard for Windows® 95/98/ME/NT/2000 series compatibility, and supports Soft-Off, STR (Suspend to RAM, S3), STD (Suspend to Disk, S4), WOM (Wake On Modem), WOL (Wake On LAN) features.



Super Multi-I/O

The AX34 Pro II provides two high-speed UART compatible serial ports and one parallel port with EPP and ECP capabilities. UART2 can also be directed from COM2 to the Infrared Module for the wireless connections.

Quick Installation Procedure

This page gives you a quick procedure on how to install your system. Follow each step accordingly.

- 1 [Installing CPU and Fan](#)
- 2 [Installing System Memory \(DIMM\)](#)
- 3 [Connecting Front Panel Cable](#)
- 4 [Connecting IDE and Floppy Cable](#)
- 5 [Connecting ATX Power Cable](#)
- 6 [Connecting Back Panel Cable](#)
- 7 [Power-on and Load BIOS Setup Default](#)
- 8 [Setting CPU Frequency](#)
- 9 Reboot
- 10 [Installing Operating System \(such as Windows 98\)](#)
- 11 [Installing Driver and Utility](#)

Motherboard Map

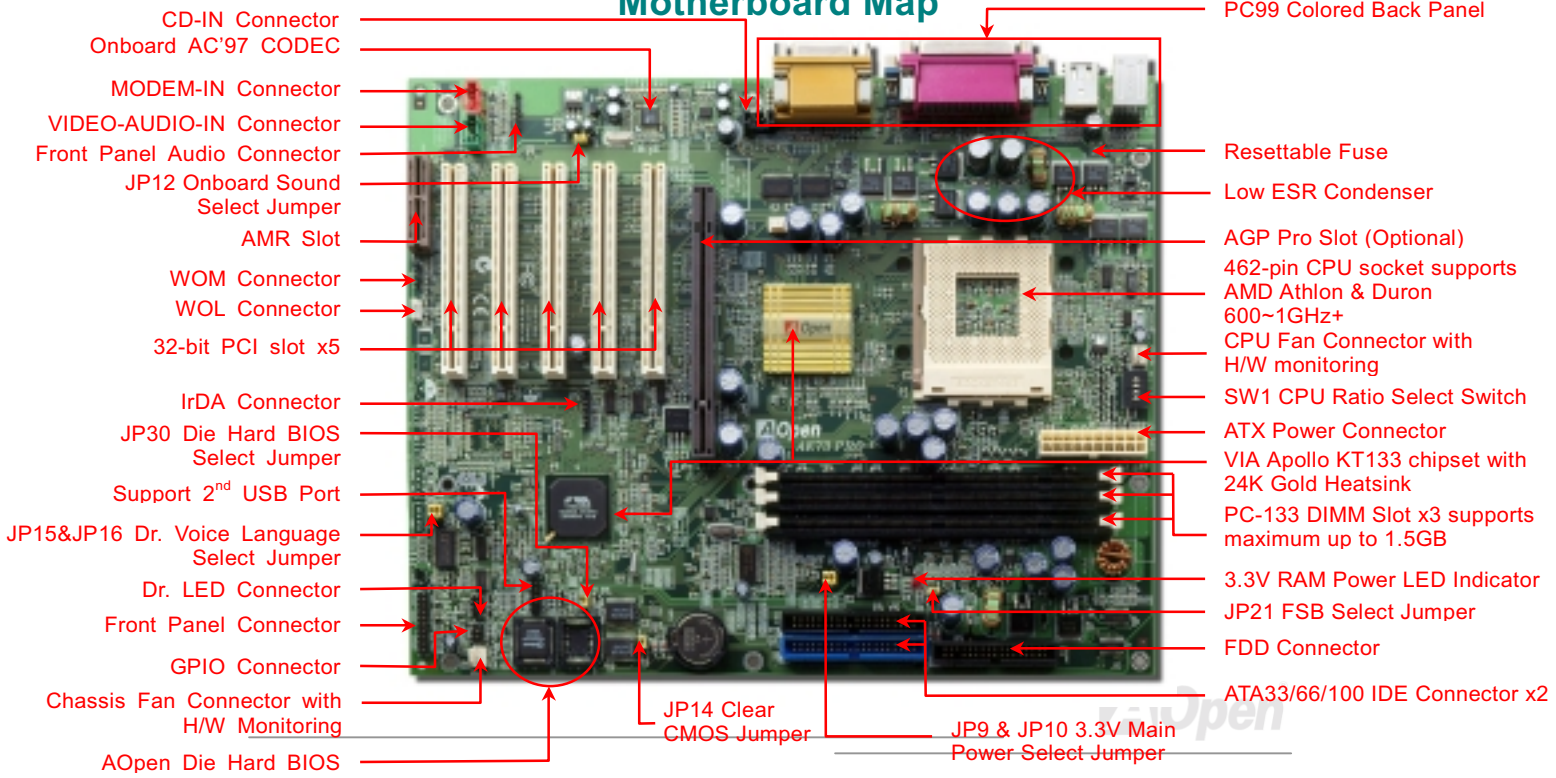

Block Diagram

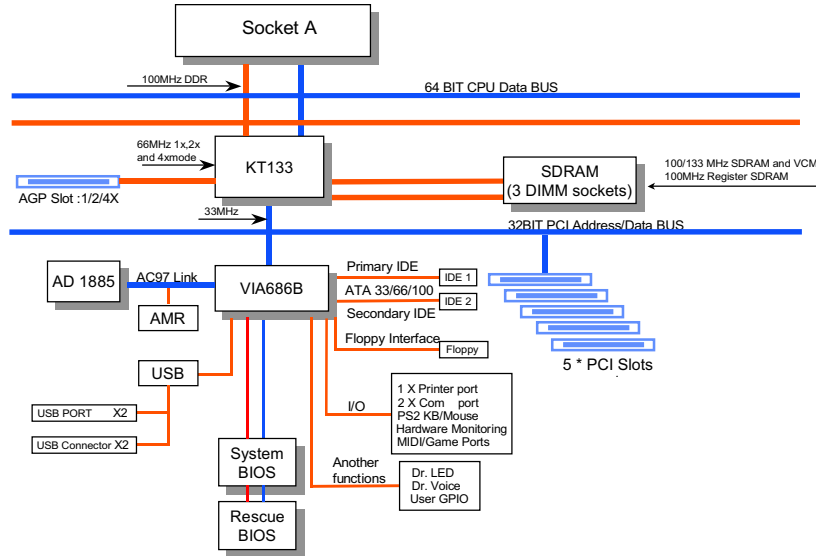

Hardware Installation

This chapter describes jumpers, connectors and hardware devices of this motherboard.

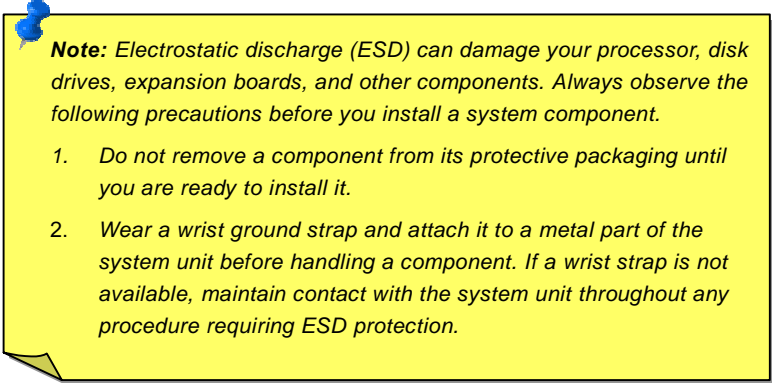

Note: Electrostatic discharge (ESD) can damage your processor, disk drives, expansion boards, and other components. Always observe the following precautions before you install a system component.

1. Do not remove a component from its protective packaging until you are ready to install it.
2. Wear a wrist ground strap and attach it to a metal part of the system unit before handling a component. If a wrist strap is not available, maintain contact with the system unit throughout any procedure requiring ESD protection.

JP14 Clear CMOS

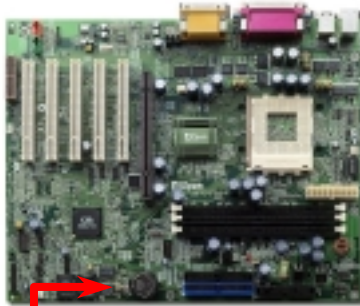

Normal Operation
(default)



Clear CMOS

You can clear CMOS to restore system default setting. To clear the CMOS, follow the procedure below.

1. Turn off the system and unplug the AC power.
2. Remove ATX power cable from connector PWR2.
3. Locate JP14 and short pins 2-3 for a few seconds.
4. Return JP14 to its normal setting by shorting pins 1 & pin2.
5. Connect ATX power cable back to connector PWR2.

Tip: When should I Clear CMOS?

1. Boot fail because of overclocking...
2. Forget password...
3. Troubleshooting...

CPU Installation

This motherboard supports AMD Athlon & Duron Socket 462 CPU. Be careful of CPU orientation when you plug it into CPU socket.

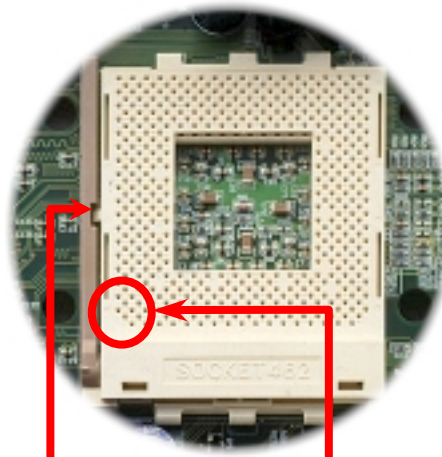

CPU socket
Lever

CPU Pin1
and cut edge

1. Pull up the CPU socket level and up to 90-degree angle.
2. Locate Pin 1 in the socket and look for a black dot or cut edge on the CPU upper interface. Match Pin 1 and cut edge. Then insert the CPU into the socket.
3. Press down the CPU socket level and finish CPU installation.

Note: If you do not match the CPU socket Pin 1 and CPU cut edge well, it may damage the CPU.

FSB/PCI Clock & Ratio

This jumper is used to specify the relationship of PCI and [FSB](#) clock. Generally speaking, if you are not an overclocker, we recommend you to set at the default setting.

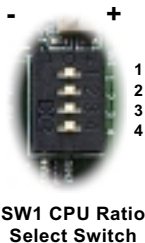
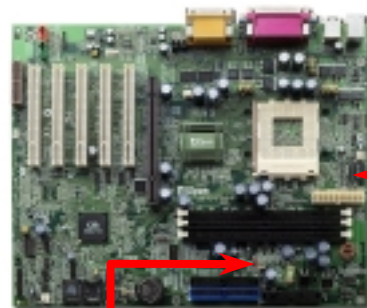

JP21 FSB Select Jumper



FSB=100-120MHz



FSB=124-166MHz

CPU Ratio	SW1-1	SW1-2	SW1-3	SW1-4
5	-	-	+	-
5.5	+	-	+	-
6	-	+	+	-
6.5	+	+	+	-
7	-	-	-	+
7.5	+	-	-	+
8	-	+	-	+
8.5	+	+	-	+
9	-	-	+	+
9.5	+	-	+	+
10	-	+	+	+
10.5	+	+	+	+
11	-	-	-	-
11.5	+	-	-	-
12	-	+	-	-
12.5	+	+	-	-
CPU Default	0	0	0	0

Note: The CPU ratio adjustable function based on the CPU type. Please refer to the technical document for more detail information of overclocking.

Open

Supported CPU Frequency

Core Frequency = **CPU Bus** Clock * CPU Ratio

EV6 Bus Speed = CPU Bus Clock x 2

PCI Clock = CPU Bus Clock / Clock Ratio

AGP Clock = PCI Clock x 2



Tip: If your system hangs or fails to boot because of overclocking, simply use <Home> key to restore the default setting (100MHz FSB/200MHz DDR Bus)

CPU	CPU Core Frequency	EV6 Bus Clock	Ratio
Athlon 600	600MHz	200MHz	6x
Athlon 650	650MHz	200MHz	6.5x
Athlon 700	700MHz	200MHz	7x
Athlon 750	750MHz	200MHz	7.5x
Athlon 800	800MHz	200MHz	8x
Athlon 850	850MHz	200MHz	8.5x
Athlon 900	900MHz	200MHz	9x
Athlon 950	950MHz	200MHz	9.5x
Athlon 1G	1GHz	200MHz	10x
Duron 600	600MHz	200MHz	6x
Duron 650	650MHz	200MHz	6.5x
Duron 700	700MHz	200MHz	7x
Duron 750	750MHz	200MHz	7.5x

Warning: VIA Apollo KT133 chipset supports maximum 133MHz/266 DDR Bus and 66MHz AGP clock, higher clock setting may cause serious system damage.

CPU Jumper-less Design

CPU VID signal and [SMBus](#) clock generator provide CPU voltage auto-detection and allows the user to set the CPU frequency through the [BIOS setup](#), therefore no jumpers or switches are used. The disadvantages of the Pentium based jumper-less designs are eliminated. There will be no worry of wrong CPU voltage detection.

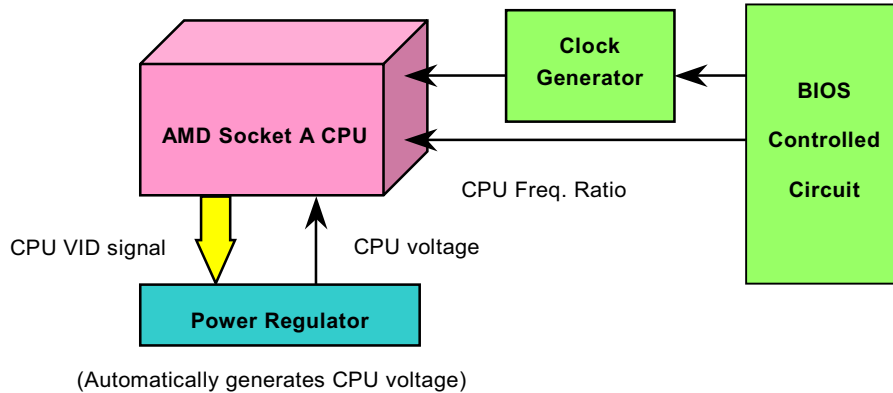

Full-range Adjustable CPU Core Voltage

This function is dedicated to overclocker, AOpen works together with Fairchild to develop a special chip FM3540 that supports Adjustable CPU Core Voltage from 1.1V to 1.85V by 0.025 stepping. But this motherboard can also automatically detect CPU VID signal and generates proper CPU core voltage.

BIOS Setup > Frequency/Voltage Control > [CPU Voltage Setting](#)

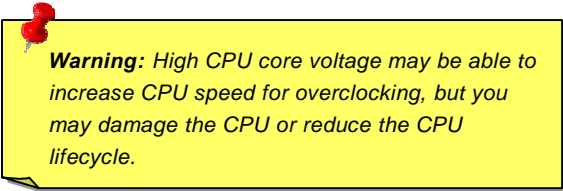

Warning: High CPU core voltage may be able to increase CPU speed for overclocking, but you may damage the CPU or reduce the CPU lifecycle.

CPU and Housing Fan Connector (With H/W Monitoring)

Plug in the CPU fan cable to the 3-pin **CPUFAN** connector. If you have housing fan, you can also plug it on **FAN2** connector.

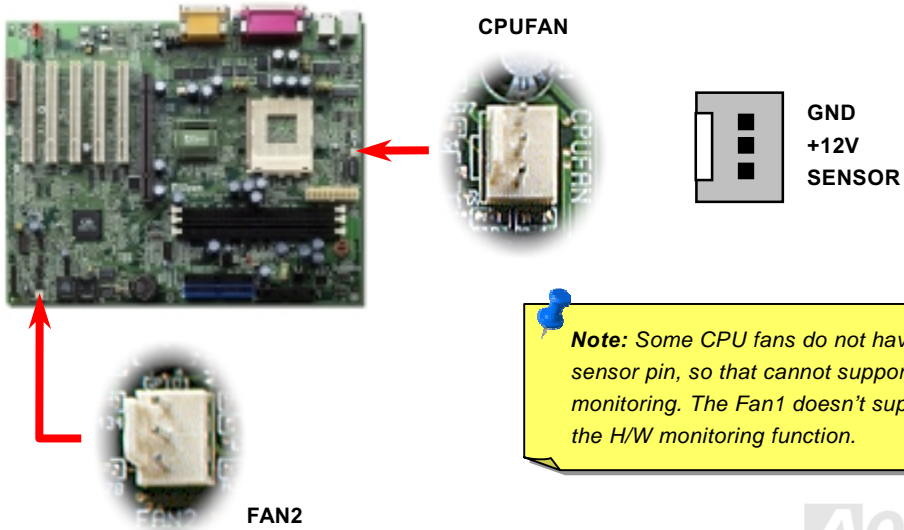

DIMM Socket

This motherboard has three 168-pin [DIMM](#) sockets that allow you to install [PC100](#) or [PC133](#) memory up to 1.5GB. The AK73 Pro supports not only [SDRAM](#) but also [VCM](#) and PC-100 Registered DRAM.

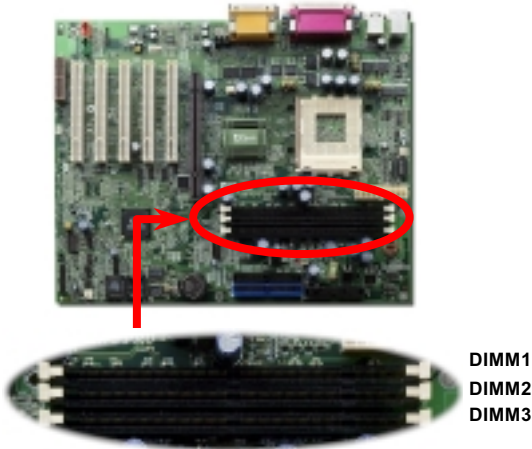

Tip: The driving capability of new generation chipset is limited due to the lack of a memory buffer (to improve performance). This makes DRAM chip count an important factor to take into consideration when you install DIMMs. Unfortunately, there is no way that the BIOS can identify the correct chip count; you need to calculate the chip count by yourself. The simple rule is: **By visual inspection, use only DIMMs that are less than 16 chips.**

DIMM can be single side or double side; it has 64 bit data and 2 or 4 clock signals. We strongly recommend choosing 4-clock SDRAM for its reliability

Tip: To identify 2-clock and 4-clock DIMM, you may check if there are traces connected to the golden finger pins 79 and 163 of the SDRAM. If there are traces, the SDRAM is probably 4-clock; otherwise, it is 2-clock.

Tip: To identify single-side or double-side DIMM, check golden finger pin 114 and pin 129. If there are traces connected to pin 114 and pin 129, the DIMM is probably double side; otherwise, it is single-side.

3.3V Main Power Adjustable

The JP9 and JP10 provide the great feature that can let you choose the 3.3V VIO value. This feature let the system get more reliable when you overclocking.

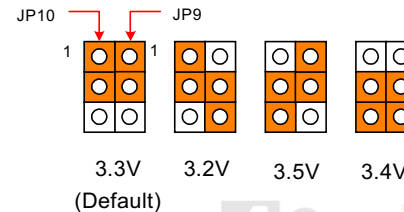
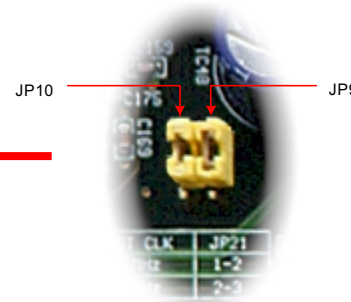
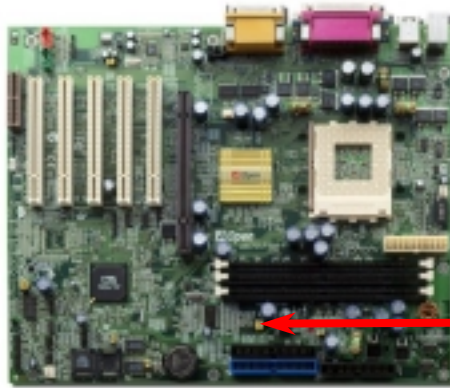

Warning: Higher voltage may be able to increase system reliability for overclocking, but you may damage/reduce the DIMM module, chipset or others 3.3V device lifecycle.

AOpen®

3.3V RAM Power LED

This LED indicates there is power applies to memory. It is useful to check RAM power during Suspend to RAM. Do not unplug memory module when this LED is on.

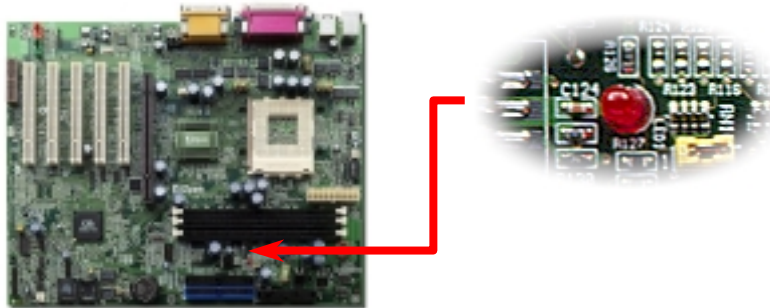

Front Panel Connector

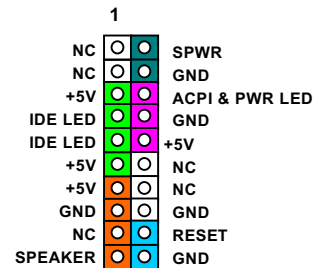
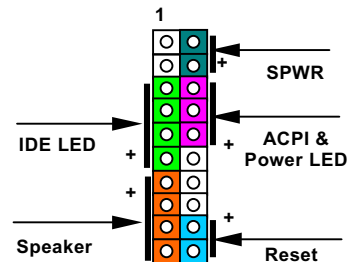
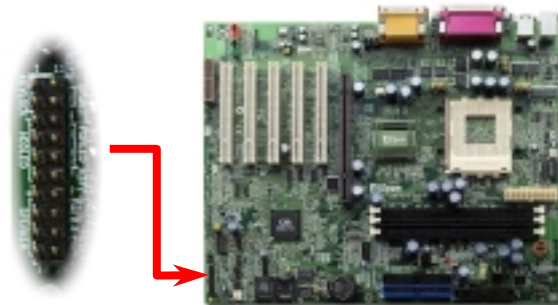

Attach the power LED, Keylock, speaker, and reset switch connectors to the corresponding pins. If you enable "[Suspend Mode](#)" item in BIOS Setup, the ACPI & Power LED will keep flashing while the system is in suspend mode.

Locate the power switch cable from your ATX housing. It is 2-pin female connector from the housing front panel. Plug this connector to the soft-power switch connector marked **SPWR**.



Attach the power LED, speaker, and reset switch connectors to the corresponding pins. If you enable **Power Management Setup > [ACPI Suspend Type](#)** in BIOS Setup, the ACPI & Power LED will keep flashing while the system is in suspend mode.

Suspend Type	ACPI LED
Power on Suspend (S1)	Flashing for every second
Suspend to RAM (S3) or Suspend to Disk (S4)	The LED will be turned off

Locate the power switch cable from your ATX housing. It is 2-pin female connector from the housing front panel. Plug this connector to the soft-power switch connector marked **SPWR**.

ATX Power Connector

The ATX power supply uses 20-pin connector shown below. Make sure you plug in the right direction.

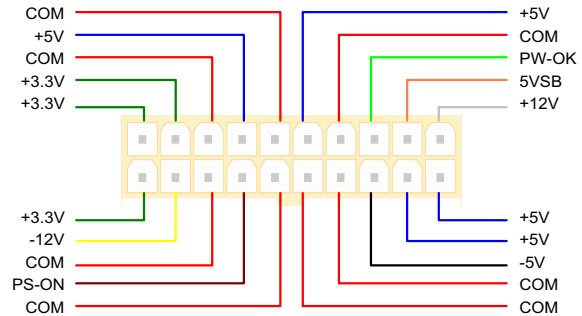

AC Power Auto Recovery

A traditional ATX system should remain at power off stage when AC power resumes from power failure. This design is inconvenient for a network server or workstation, without an UPS, that needs to keep power-on. This motherboard implements an AC Power Auto Recovery function to solve this problem. If BIOS Setup > Integrated Peripherals > [AC PWR Auto Recovery](#) is set to “On” the system will automatically power-on after AC power resumes.

IDE and Floppy Connector

Connect 34-pin floppy cable and 40-pin IDE cable to floppy connector FDC and IDE connector. The **blue connector** is IDE1 for clear identification. Be careful of the pin1 orientation. Wrong orientation may cause system damage.

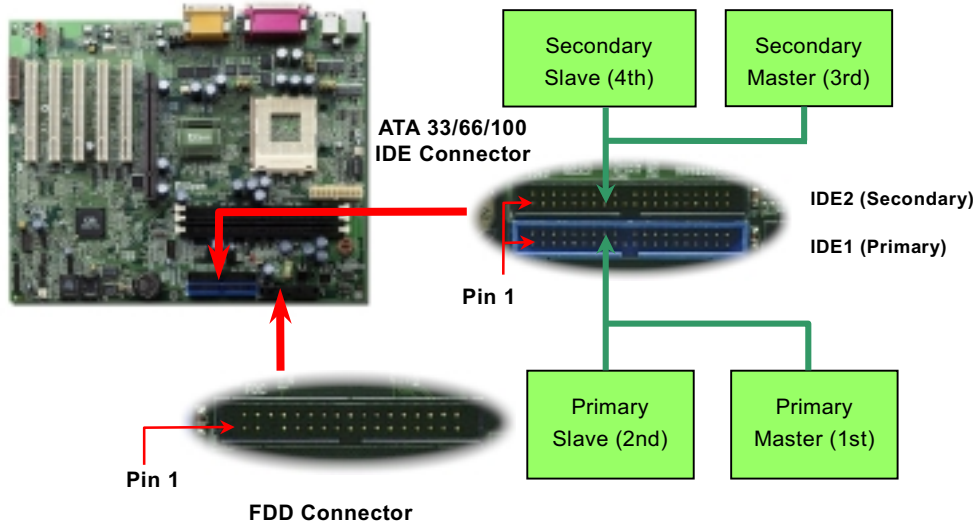

IDE1 is also known as the primary channel and IDE2 as the secondary channel. Each channel supports two IDE devices that make a total of four devices. In order to work together, the two devices on each channel must be set differently to **Master** and **Slave** mode. Either one can be the hard disk or the CDROM. The setting as master or slave mode depends on the jumper on your IDE device, so please refer to your hard disk and CDROM manual accordingly.

Warning: *The specification of the IDE cable is a maximum of 46cm (18 inches), make sure your cable does not exceed this length.*

Tip: *For better signal quality, it is recommended to set the far end side device to master mode and follow the suggested sequence to install your new device. Please refer to above diagram*

This motherboard supports [ATA33](#), [ATA66](#) or [ATA100](#) IDE devices. Following table lists the transfer rate of IDE PIO and DMA modes. The IDE bus is 16-bit, which means every transfer is two bytes.

Mode	Clock Period	Clock Count	Cycle Time	Data Transfer Rate
PIO mode 0	30ns	20	600ns	$(1/600\text{ns}) \times 2\text{byte} = 3.3\text{MB/s}$
PIO mode 1	30ns	13	383ns	$(1/383\text{ns}) \times 2\text{byte} = 5.2\text{MB/s}$
PIO mode 2	30ns	8	240ns	$(1/240\text{ns}) \times 2\text{byte} = 8.3\text{MB/s}$
PIO mode 3	30ns	6	180ns	$(1/180\text{ns}) \times 2\text{byte} = 11.1\text{MB/s}$
PIO mode 4	30ns	4	120ns	$(1/120\text{ns}) \times 2\text{byte} = 16.6\text{MB/s}$
DMA mode 0	30ns	16	480ns	$(1/480\text{ns}) \times 2\text{byte} = 4.16\text{MB/s}$
DMA mode 1	30ns	5	150ns	$(1/150\text{ns}) \times 2\text{byte} = 13.3\text{MB/s}$
DMA mode 2	30ns	4	120ns	$(1/120\text{ns}) \times 2\text{byte} = 16.6\text{MB/s}$
UDMA 33	30ns	4	120ns	$(1/120\text{ns}) \times 2\text{byte} \times 2 = 33\text{MB/s}$
UDMA 66	30ns	2	60ns	$(1/60\text{ns}) \times 2\text{byte} \times 2 = 66\text{MB/s}$
UDMA100	20ns	2	40ns	$(1/40\text{ns}) \times 2\text{byte} \times 2 = 100\text{MB/s}$

Tip: To achieve the best performance of Ultra DMA 66/100 hard disks, a special **80-wires IDE cable** for Ultra DMA 66/100 is required.

IrDA Connector

The IrDA connector can be configured to support wireless infrared module, with this module and application software such as Laplink or Windows 95 Direct Cable Connection, the user can transfer files to or from laptops, notebooks, PDA devices and printers. This connector supports HPSIR (115.2Kbps, 2 meters) and ASK-IR (56Kbps).

Install the infrared module onto the **IrDA** connector and enable the infrared function from BIOS Setup, [UART2 Mode](#), make sure to have the correct orientation when you plug in the IrDA connector.

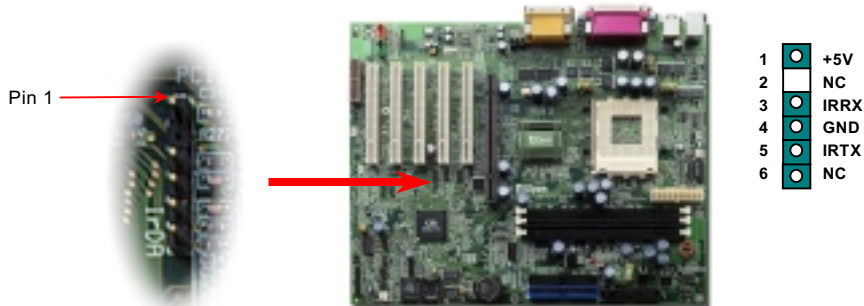

WOM (Zero Voltage Wake on Modem)

This motherboard implements special circuit to support Wake On Modem, both Internal modem card and external box modem are supported. Since Internal modem card consumes no power when system power is off, it is recommended to use an internal modem. To use internal modem, connect 4-pin cable from **RING** connector of modem card to the **WOM** connector on the motherboard.

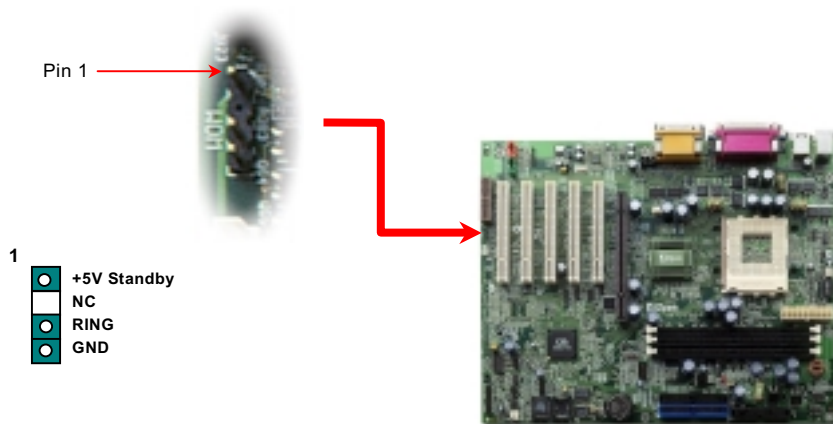

WOM by External BOX Modem

Traditional Green PC suspend mode does not really turn off the system power supply, it uses external box modem to trigger MB COM port and resume back to active.

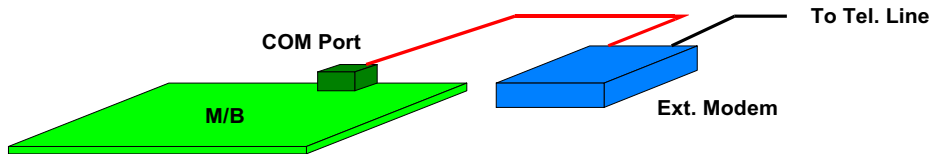

WOM by Internal Modem Card

With the help of the ATX soft power On/Off, it is possible to have a system totally power off, and wakeup to automatically answer a phone call as an answering machine or to send/receive a fax. You may identify whether or not your system is in true power off mode by checking to see if the fan of your power supply is off. Both an external box modem and an internal modem card can be used to support Modem Wake Up, but if you use an external modem, you have to leave your box modem on.

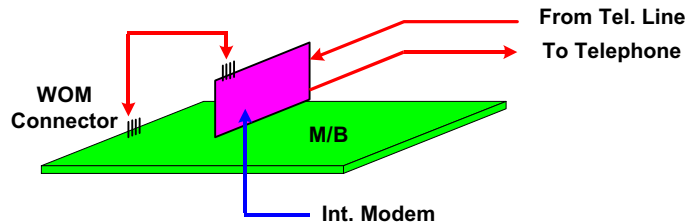

Note: With AOpen Motherboard plus AOpen Modem Card, the power can be totally off.

AOpen®

WOL (Wake on LAN)

This feature is very similar as [Wake On Modem](#), but it goes through local area network. To use Wake On LAN function, you must have a network card with chipset that supports this feature, and connect a cable from LAN card to motherboard WOL connector. The system identification information (probably IP address) is stored on network card and because there is a lot of traffic on the Ethernet, you need to install network management software, such as ADM, for the checking of how to wake up the system. Note that, at least 600mA ATX standby current is required to support the LAN card for this function.

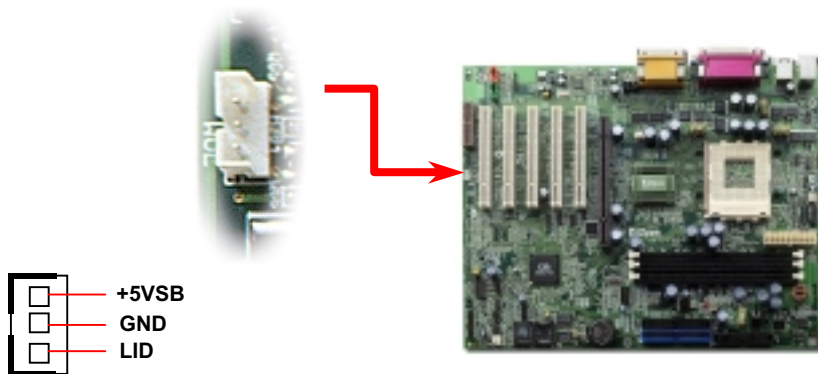

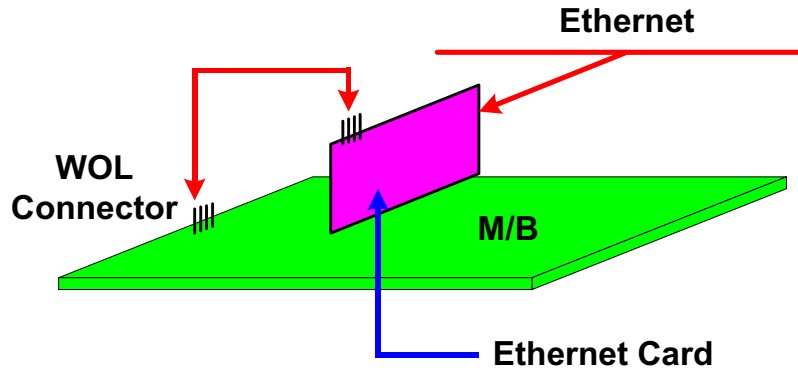

AGP (Accelerated Graphic Port)

The AK73 Pro provides an [AGP](#) 4x (AGP Pro is optional) slot. The AGP 4x/Pro is a bus interface targeted for high-performance 3D graphic. Recently, there are more memory modules on the AGP card. Hence, the AGP card needs more power to drive these chips. The AGP Pro interface has more power pins to provide more power for the card. AGP supports only memory read/write operation and single-master single-slave one-to-one only. AGP uses both rising and falling edge of the 66MHz clock, for 2X AGP, the data transfer rate is $66\text{MHz} \times 4\text{bytes} \times 2 = 528\text{MB/s}$. AGP is now moving to AGP 4x/Pro mode, $66\text{MHz} \times 4\text{bytes} \times 4 = 1056\text{MB/s}$.

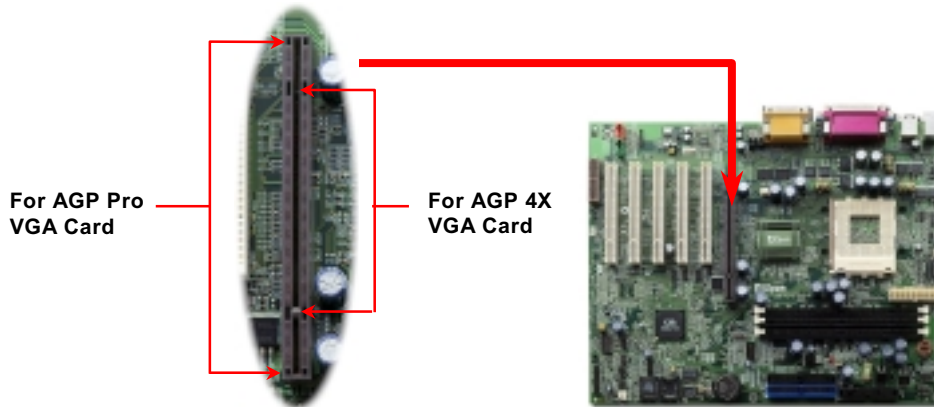

AMR (Audio/Modem Riser)

[AMR](#) is a riser card that supports sound or modem function. Because CPU computing power is getting stronger, the digital processing job can be implemented in main chipset and share CPU power. The analogical conversion ([CODEC](#)) circuit requires a different and separate circuit design, it is put on AMR card. This motherboard implements sound CODEC on board (can be disabled by JP12), but reserve AMR slot for the option of modem function. Note that you can still use PCI modem card.

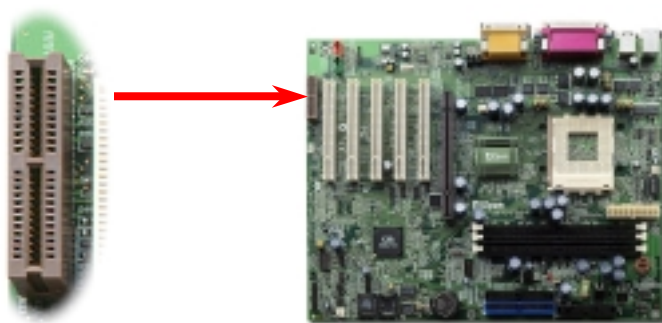

PC99 Color Coded Back Panel

The onboard I/O devices are PS/2 Keyboard, PS/2 Mouse, serial ports COM1 and COM2, Printer, [four USB](#), AC97 sound and Game port. The view angle of drawing shown here is from the back panel of the housing.

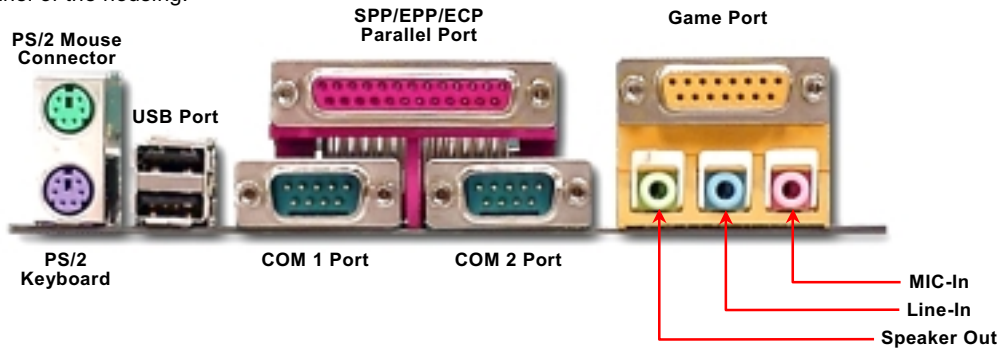

Speaker Out: To External Speaker, Earphone or Amplifier.

Line-In: From the signal source, such as CD/Tape player.

MIC-In: From Microphone.

Game Prot: To 15-pin PC joystick or game pad.

Support 2nd USB Port

This motherboard supports four USB ports. Two of them are on back panel connector, the other two are on the left-bottom area of this motherboard. With proper cable, you can connect them to front panel.

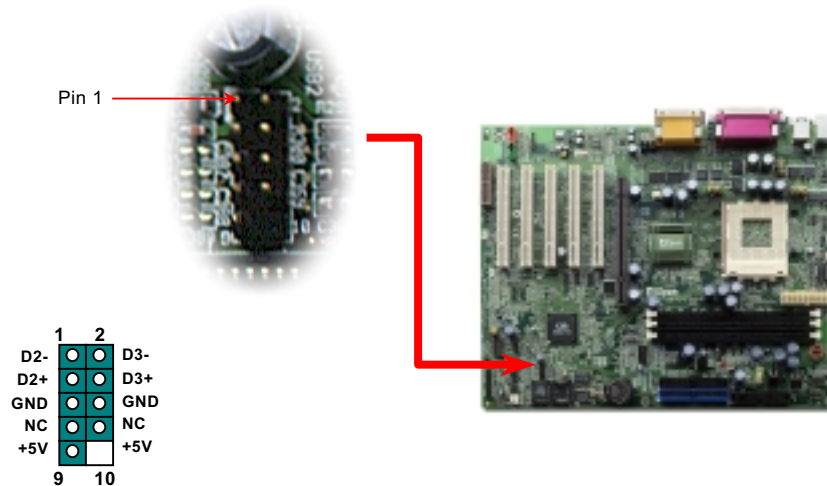

JP12 Enable/Disable Onboard Sound

This motherboard has [AC97](#) sound onboard. JP12 is used to enable or disable onboard AD1885 [CODEC](#) chip. If you don't want to enable the Onboard Audio, you should set this jumper to 2-3, and disable the "OnChip Sound" from BIOS setting > Advanced Chipset Features, before you install your preferred PCI Sound Card.

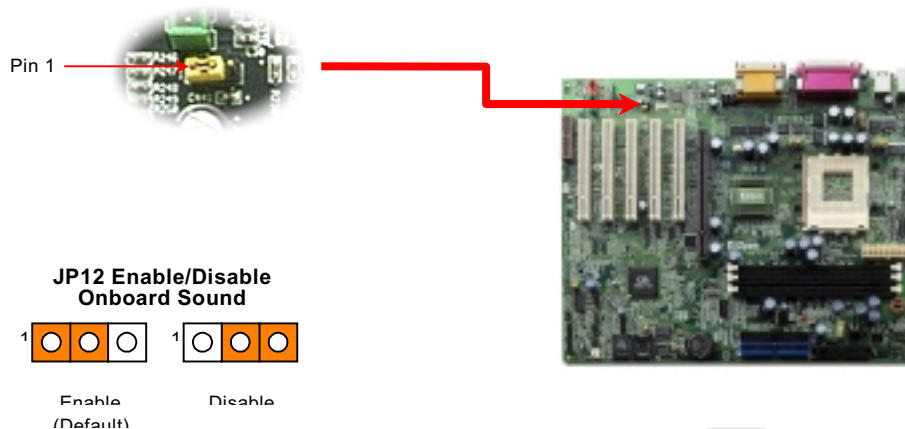

CD Audio Connector

This **black** connector is used to connect CD Audio cable from CDROM or DVD drive to onboard sound.

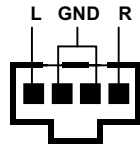

CD-IN

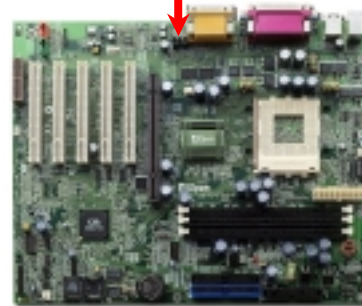

Modem Audio Connector

This connector is used to connect Mono In/Mic Out cable from internal modem card to onboard sound circuit. The pin 1-2 is **Mono In**, and the pin 3-4 is **Mic Out**. Please note that there is no standard for this kind of connector yet, only some internal modem cards implement this connector.

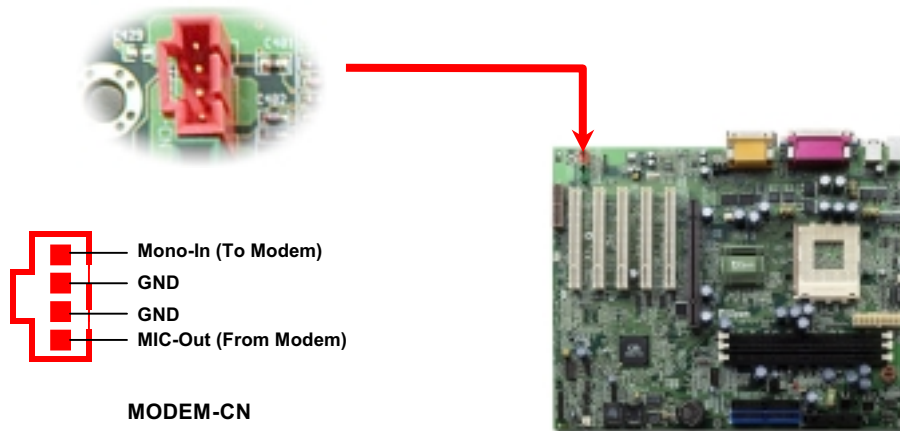

Video-Audio-IN Connector

This **green** connector is used to connect MPEG Audio cable from MPEG card to onboard sound.

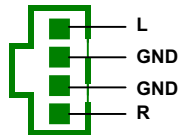
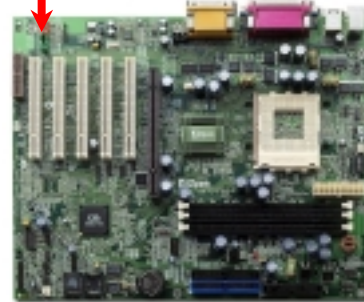

VIDEO_AUDIO_IN

Front Panel Audio (Optional)

If the housing has been design with an audio port on the front panel, you'll be able to connect onboard audio to front panel through this connector.

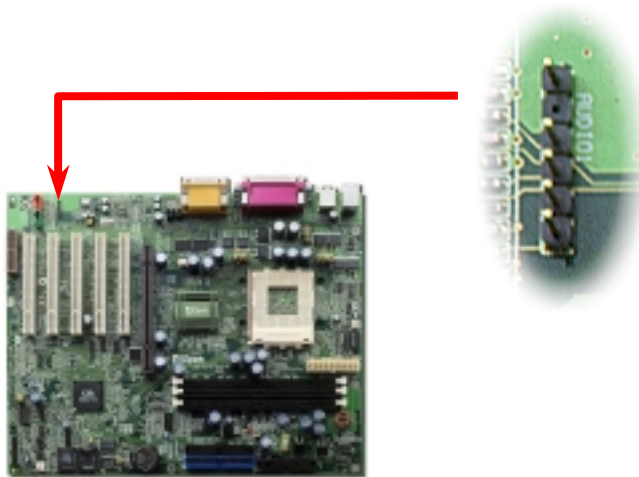

- 1 GND
- 2 NC
- 3 Phone_R
- 4 Phone_L
- 5 NC
- 6 FP_Mic

Battery-less and Long Life Design

This Motherboard implements [Flash ROM](#) and a special circuit that allows you to save your current CPU and CMOS Setup configurations without the need of a battery. The RTC (real time clock) can also keep running as long as the power cord is plugged. If you lose your CMOS data by accident, you can just reload the CMOS configurations from [Flash ROM](#) and the system will recover as usual.

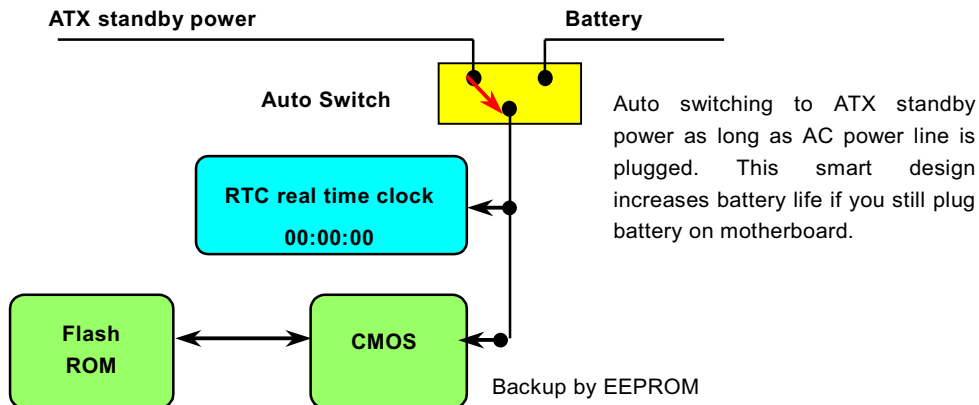

Over-current Protection

The Over Current Protection was very popular implemented on ATX 3.3V/5V/12V switching power supply. However, the new generation CPU uses different voltage that has regulator to transfer 5V to CPU voltage (for example, 2.0V), and makes 5V over current protection useless. This motherboard is with switching regulator onboard supports CPU over-current protection; in conjunction with 3.3V/5V/12V power supply provide the full line over-current protection.

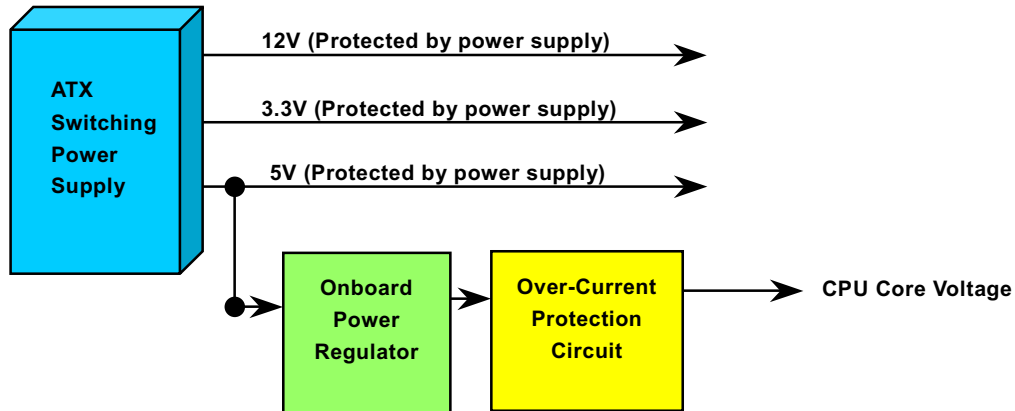



Note: Although we have implemented protection circuit try to prevent any human operating mistake, there is still certain risk that CPU, memory, HDD, add-on cards installed on this motherboard may be damaged because of component failure, human operating error or unknown nature reason. **AOpen cannot guaranty the protection circuit will always work perfectly.**

Hardware Monitoring

This motherboard implements a hardware monitoring system. As you turn on your system, this smart design will continue to monitor your system's working voltage, fan status and CPU temperature. If any of these system's status go wrong, there will be an alarm through the AOpen [Hardware Monitoring Utility](#) to warn the user.

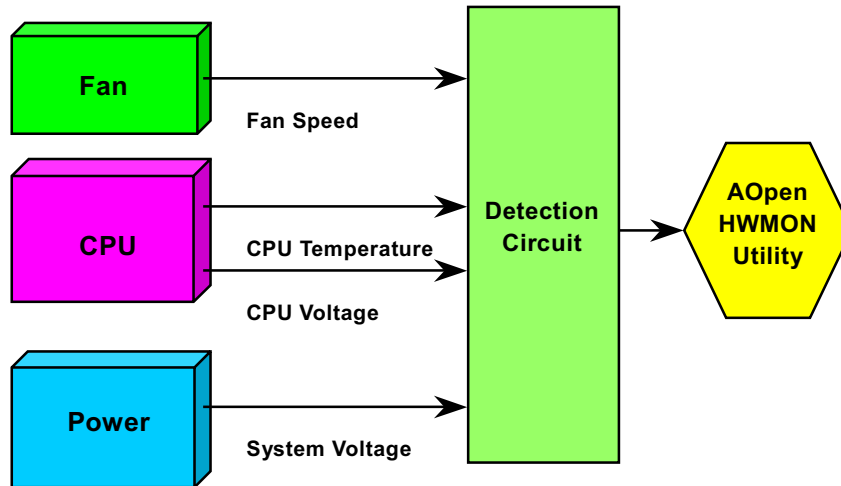

Resettable Fuse

Traditional motherboard has fuse for Keyboard and [USB](#) port to prevent over-current or shortage. These fuses are soldered onboard that when it is broken (did the job to protect motherboard), user still cannot replace it and the motherboard is still malfunction.

With expensive Resettable Fuse, the motherboard can back to normal function after fuse did the protection job.

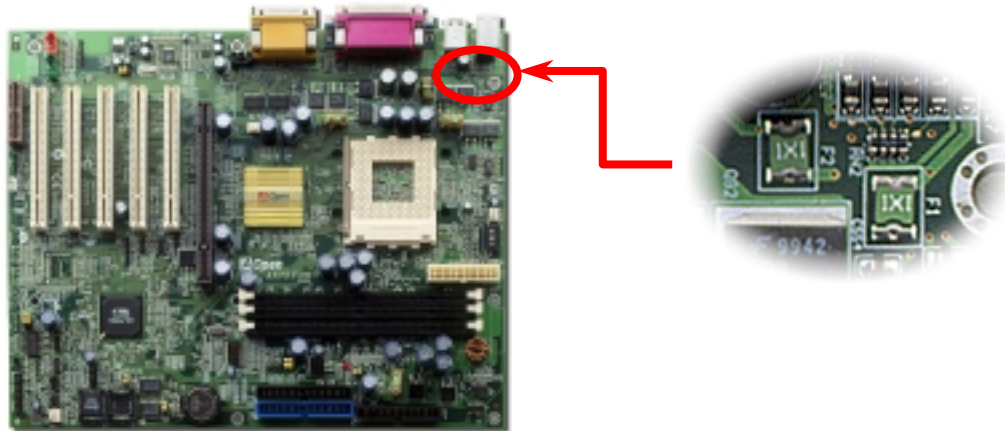

JP30 Die-Hard BIOS (100% Virus Protection)

Recently, many viruses have been found that may destroy bios code and data area. This motherboard implements a very effective hardware protection method that does not involve any software or BIOS coding, hence is 100% virus free. There is a BIOS flash ROM mounted on the M/B when you get it. If you want to add extra BIOS flash ROM, please contact the local distributor or reseller. You also can link to AOpen official website: www.aopen.com.tw by Internet to purchase it.

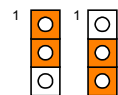

Normal Rescue
(Default)

Pin 1

Rescue
BIOS
Socket

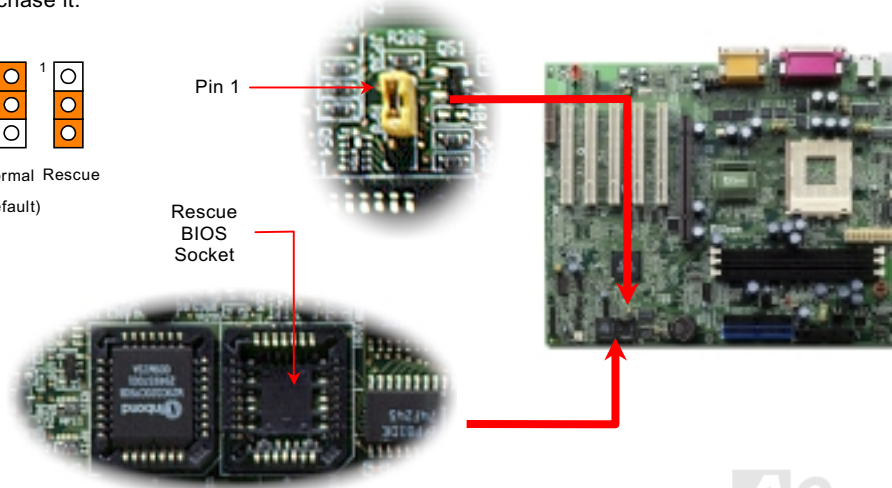

External Controller for DIE-HARD BIOS (Optional)

External Controller provides you a better and convenience way to switch the BIOS status between “**Rescue**” and “**Normal**” without opening the case of your computer. You have to plug the jumper cable to the connector pin (**JP30**) on the motherboard. Be careful of the orientation when you connect, the red wire should correspond to Pin1.

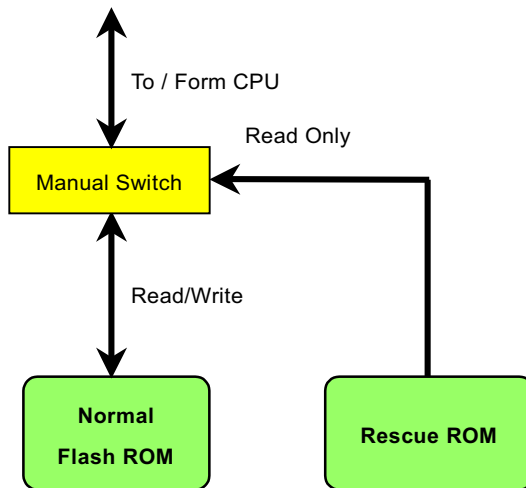

Note: If you suspect your BIOS is infected by virus, just rescue your bios by following steps:

1. Turn off the system, set the External Controller to "**Rescue**" to read from rescue ROM.
2. Boot the system and set the switch back to "**Normal**".
3. Follow the BIOS upgrade procedure to rehabilitate BIOS.

Reboot the system, and you should be able to back to normal.

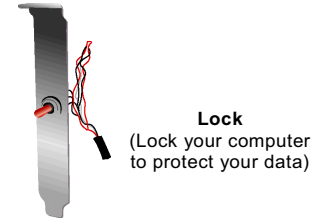
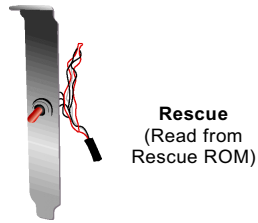
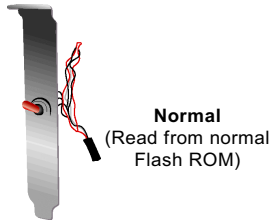

Tip: If you place the switch to the middle, you will not be able to boot your system, thus you can protect your data from

GPO (General Purpose Output) Connector

GPO (General Purpose Output) is an advanced specification developed by AOpen for power users to define the further function by oneself. For example, you can design a daughter board to provide additional capabilities, such as an alarm, a buzzer, a timekeeper, etc.

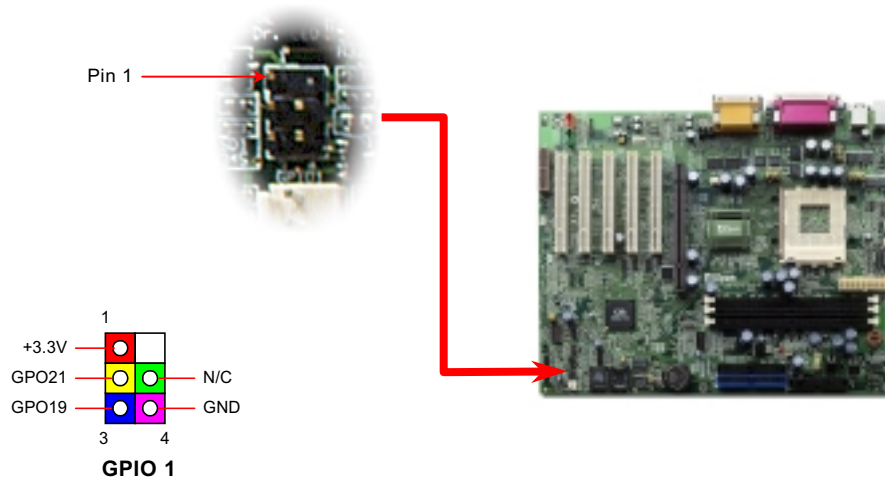

Dr. LED Connector (Optional)

In conjunction with Dr. LED (Optional), which can easily show what kind of problem you may incur on your system during assembly. It can clearly indicate whether there is a component issue or an installed issue by the 8 LEDs on the front panel of Dr. LED. This helps you quickly self-diagnostic your system status.

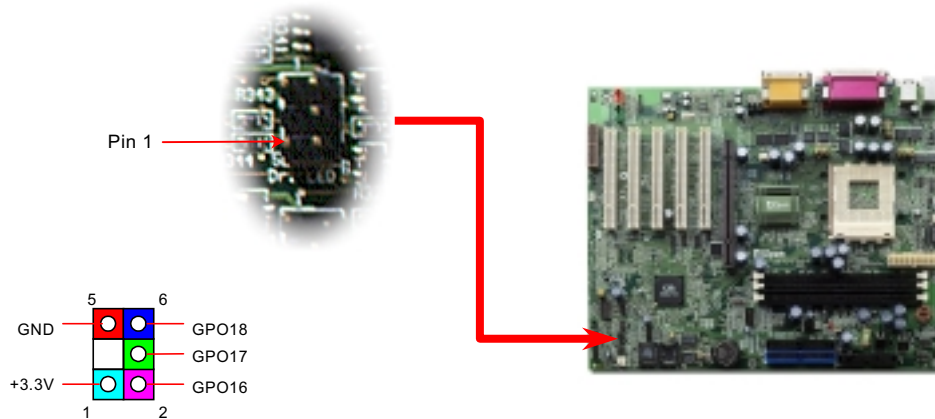

Dr. LED

Dr. LED is a CD disc storage box with 8 LEDs on its front panel, the size of Dr. LED is exactly the same as 5.25 in floppy drive, so that it can be mount into normal 5.25 in drive bay of any housing.

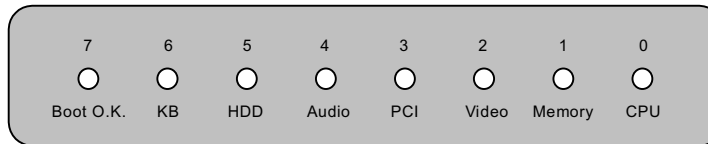

The total 8 LEDs light up alternatively if the system fails in one of eight stages. Once the LED7 (latest LED) is lit, this indicates that the system has completed its boot-up procedure.

The 8 LEDs indicate the following messages when lit:

LED 0 - Indicates that the CPU may have been installed incorrectly or is damaged.

LED 1 - Indicates that the memory may have been installed incorrectly or is damaged.

LED 2 - Indicates that the AGP may have been installed incorrectly or is damaged.

LED 3 - Indicates that the PCI card may have been installed incorrectly or is damaged.

LED 4 - Indicates that the floppy disk drive may have been installed incorrectly or is damaged.

LED 5 - Indicates that the HDD may have been installed incorrectly or is damaged.

LED 6 - Indicates that the keyboard may have been installed incorrectly or is damaged.

LED 7 - Indicates that the system is OK.

Note: During POST (power on self test) procedure, the Debug LED will light on sequentially from LED0 to LED7 until the system boot O.K

Dr. Voice (Optional)

The **Dr. Voice** is a great feature of AX34 Pro II. It can let you easily to know what kind of problem occurred. It can clearly “**tell**” whether there is a component issue or an installed issue, such as CPU, memory module, VGA, PCI add-on card, FDD, HDD or keyboard by voice. The Dr. Voice provides four kinds of language version, **English, German, Japanese** and **Chinese** for choosing. You can select preferred language version by **JP15 & JP16**.

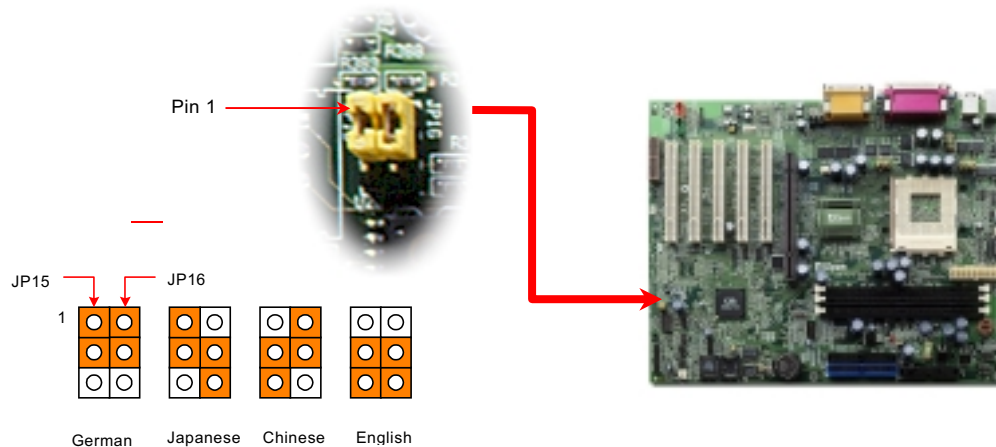

Year 2000 (Y2K)

Y2K is basically a problem of the identification of year code. To save storage space, traditional software uses only two digits for year identification. For example, 98 for 1998 and 99 for 1999, but 00 will be confused with 1900 and 2000.

There is an RTC circuit (Real Time Clock) in conjunction with 128 bytes of CMOS RAM data in the chipset of the motherboard. The RTC has only two digits and the CMOS has another 2 digits. Unfortunately, this circuit's behavior is like this 1997 → 1998 → 1999 → 1900, that means it may have the Y2K problem. Below is a diagram of how applications work with the OS, BIOS and RTC. In order to keep the best compatibility in the PC industry there is a rule that applications must call the OS to get services and OS must call the BIOS, and then only BIOS is allowed to access the hardware (RTC) directly.

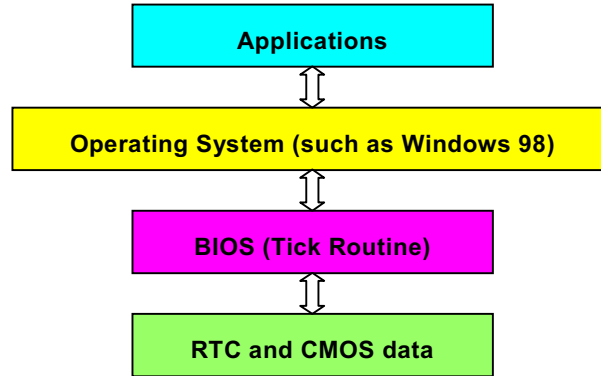

There is a Tick Routine (that goes live around every 50m sec) in the BIOS to keep record of date/time information. In general the BIOS, this Tick Routine does not update the CMOS every time because the CMOS is a very slow device that degrades system performance. The Tick Routine of the AOpen BIOS has 4 digits for year coding, as long as applications and the operating system follow the rule to get date/time information. There will be no Y2K problem (such as NSTL's test program). But unfortunately again, we found some test programs (such as Checkit 98) accesses RTC/CMOS directly. **This motherboard has hardware Y2K checking and protection that ensures risk free operation.**

Low ESR Capacitor

The quality of low ESR capacitor (Low Equivalent Series Resistance) during high frequency operation is very important for stability of CPU power. The location of where to put these capacitors is another know-how that requires experience and detail calculation.

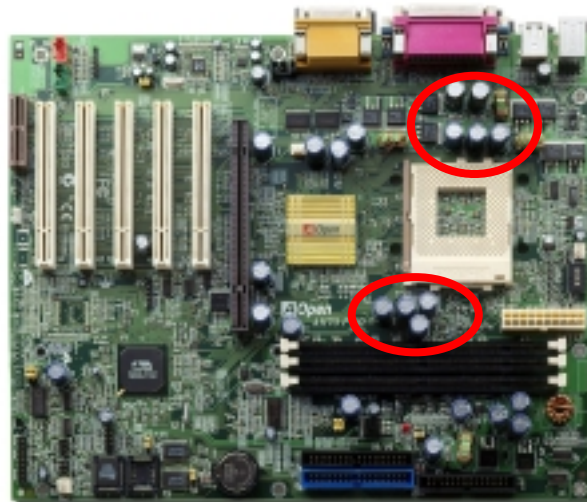

AOpen

The power circuit of the CPU core voltage must be checked to ensure system stability for high speed CPUs (such as the new Pentium III, or when overclocking). A typical CPU core voltage is 2.0V, so a good design should control voltage between 1.860V and 2.140V. That is, the transient must be below 280mV. Below is a timing diagram captured by a Digital Storage Scope, it shows the voltage transient is only 143mV even when maximum 18A current is applied.

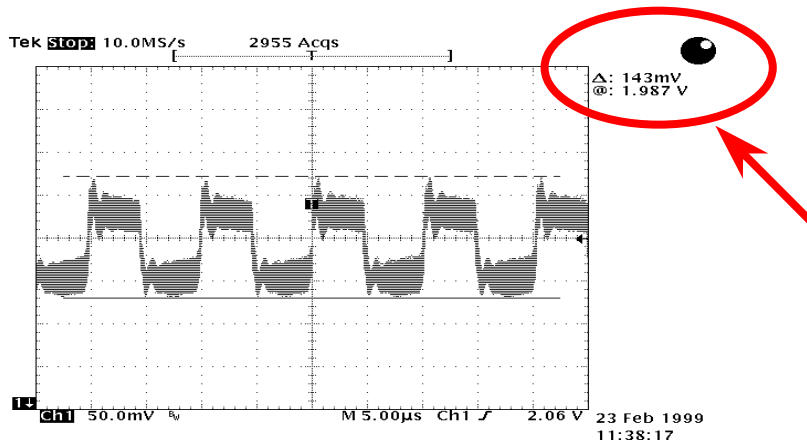

Note: This diagram for example only, it may not be exactly the same as this motherboard.

Layout (Frequency Isolation Wall)

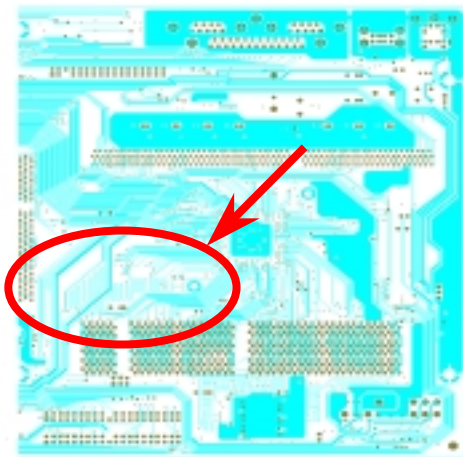

Note: This diagram for example only, it may not be exactly the same as this motherboard.

For high frequency operation, especially overclocking, layout is the most important factor to make sure chipset and CPU working in stable condition. The layout of this motherboard implements AOpen's unique design called "Frequency Isolation Wall". Separating each critical portion of motherboard into regions where each region operates in a same or similar frequency range to avoid cross talk and frequency interference between each region's operations and condition. The trace length and route must be calculated carefully. For example, the clock trace must be equal length (not necessarily as short as possible) so that clock skew will be controlled within few a pico second ($1/10^{12}$ Sec)

AOpen

24K Gold Heatsink

Cool down CPU and Chipset is important for system reliability. Gold Heatsink provides better heat consumption especially when you are trying to overclock.

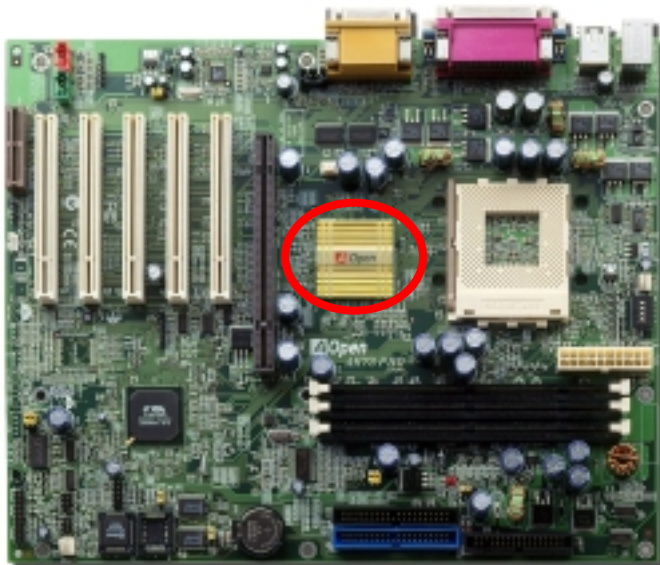

Driver and Utility

There are motherboard drivers and utilities included in [AOpen Bonus CD disc](#). You don't need to install all of them in order to boot your system. But after you finish the hardware installation, you have to install your operation system first (such as Windows 98) before you can install any drivers or utilities. Please refer to your operation system's installation guide.

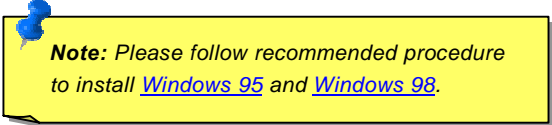

Note: Please follow recommended procedure to install [Windows 95](#) and [Windows 98](#).

Autorun Menu from Bonus CD Disc

You can use the autorun menu of Bonus CD disc. Choose the utility and driver and select model name.

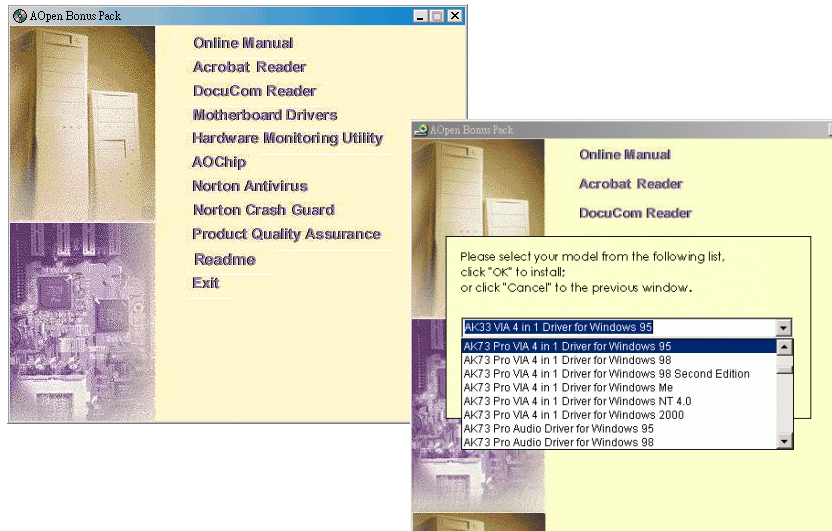

Installing Windows 95

1. First, don't install any add-on card except [AGP](#) card.
2. Install Windows 95 OSR2 v2.1, 1212 or 1214 version and later with USB support. Otherwise, you need to install USBSUPP.EXE.
3. Install the [VIA 4 in 1 driver](#), which includes VIA AGP Vxd driver, VIA ATAPI Vendor Support driver and VIA registry (INF) program.
4. Finally, Install other add-on cards and their drivers.

Installing Windows 98

1. First, don't install any add-on card except [AGP](#) card.
2. Enable USB Controller in BIOS Setup > Advanced Chipset Features > [USB Controller](#), to make BIOS fully capable of controlling IRQ assignment.
3. Install Window 98 into your system.
4. Install the [VIA 4 in 1 driver](#), which includes VIA AGP Vxd driver, IRQ Routing, VIA ATAPI Vendor Support driver and VIA registry (INF) program.
5. Finally, Install other add-on cards and their drivers.

Installing Windows 98 SE, Windows ME & Windows2000

If you are using Windows® 98 Second Edition, Windows® Millennium Edition or Windows® 2000, you do not need to install the 4-in-1 driver as the IRQ Routing Driver and the ACPI Registry are already incorporated into the operating system. Users with Windows® 98 SE may update the VIA Registry INF and AGP drivers by installing them individually.

Please refer to [VIA Technologies Inc.](http://www.via.com/) for latest version of 4 in 1 driver:

<http://www.via.com/>

<http://www.via.com/drivers/4in1420.exe>

Installing VIA 4 in 1 Driver

You can install the VIA 4 in 1 driver ([IDE Bus master](#) (For Windows NT use), VIA ATAPI Vendor Support Driver, VIA [AGP](#), IRQ Routing Driver (For Windows 98 use), VIA Registry (INF) Driver) from the Bonus Pack CD disc Autorun menu.

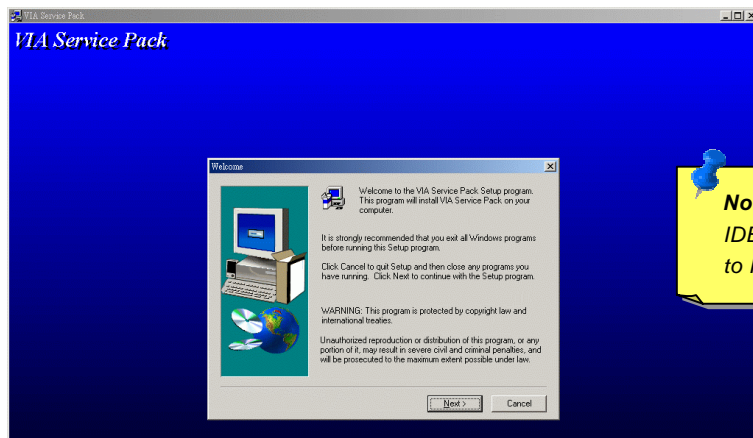

Note: Installing this Bus Master IDE driver may cause Suspend to Hard Drive failure.

Warning: If you want to uninstall the VIA AGP Vxd driver, please remove the AGP card driver first. Otherwise, the screen may go black at rebooting after the un-installation.

Installing Onboard Sound Driver

This motherboard comes with an AD 1885 [AC97 CODEC](#) and the sound controller is in VIA South Bridge chipset. You can find the audio driver from the Bonus Pack CD disc Autorun menu.

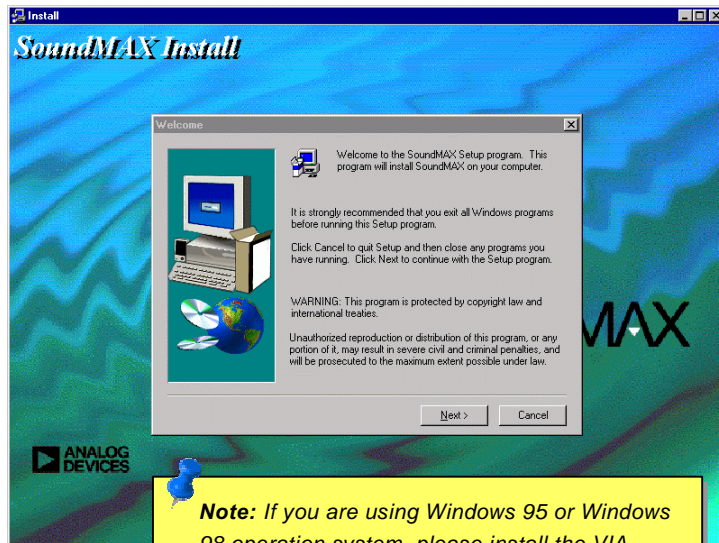

Note: If you are using Windows 95 or Windows 98 operation system, please install the VIA audio driver to instead the AD audio driver.

Installing Hardware Monitoring Utility

You can install Hardware Monitoring Utility to monitor CPU temperature, fans and system voltage. The hardware monitoring function is automatically implemented by the BIOS and utility software. No hardware installation is needed.

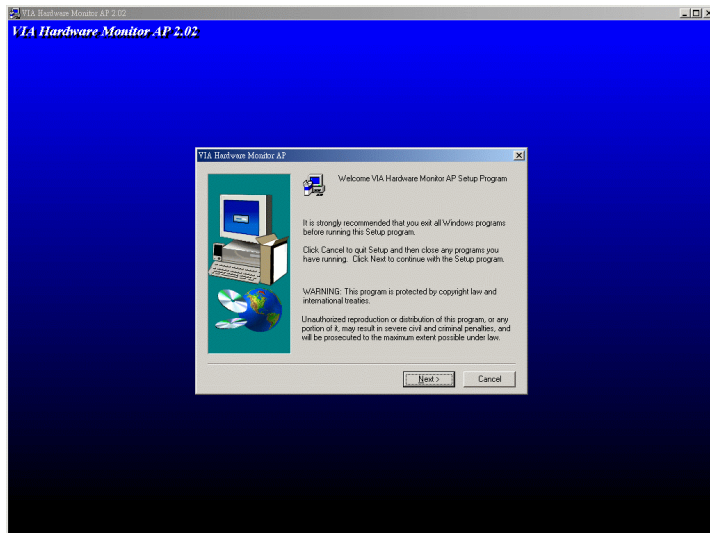

ACPI Suspend to Hard Drive

[ACPI](#) Suspend to Hard Drive is basically controlled by Windows operation system. It saves your current work (system status, memory and screen image) into hard disk, and then the system can be totally power off. Next time, when power is on, you can resume your original work directly from hard disk within few seconds without go through the Windows booting process and run your application again. If your memory is 64MB, normally, you need to reserve at least 64MB HDD space to save your memory image.

When go into Suspend:

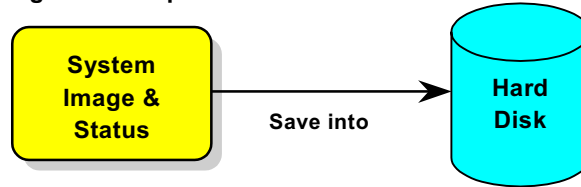

When power-on next time:

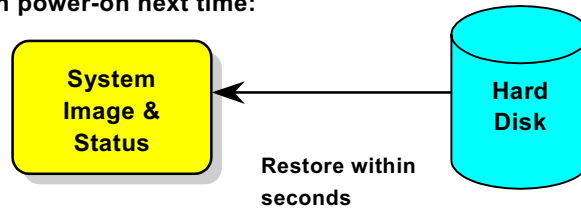

System Requirement

1. **AOZVHDD.EXE 1.30b** or later.
2. Delete **config.sys** and **autoexec.bat**.

Fresh installation of Windows 98 on a new system

1. Execute "**Setup.exe /p j**" to install Windows 98
2. After Windows 98's installation is complete, go to the **Control Panel > Power Management**.
 - a. Set **Power Schemes > System Standby** to "Never".
 - b. Click on "Hibernate" and select "Enable Hibernate Support" then "Apply".
 - c. Click on the "Advanced" tab, you'll see "Hibernate" on "Power Buttons". Note that this option will only be seen after step b mentioned above has been completed, otherwise only "Standby" and "Shutdown" will be shown. Select "Hibernate" and "Apply".
3. Clean boot into DOS and run AOZVHDD utility.
 - a. If you assign the whole disk to your Win 98 system (FAT 16 or FAT 32), please run "**aozvhd /c /file**". Please remember sufficient free space has to be reserved in the disk, e.g. if you have 64 MB DRAM and 16 MB VGA card installed, the system needs at least 80 MB free space. The utility will locate the space automatically.

b. If you assign an individual partition for Win 98, please run "**aozvhd /c /partition**". Of course, the system needs to provide unformatted an empty partition.

4. Reboot system.

5. You've already implemented ACPI Suspend to-Hard Drive. Click "**Start > Shut Down > Standby**" then the screen will go off immediately. And 1 minute or so will be taken for the system to save what's in the memory to the hard drive; the larger the memory size the longer this process will take.

Changing from APM to ACPI (Windows 98 only)

1. Run "Regedit.exe"

- a. Go through the following path

HKEY_LOCAL_MACHINE

SOFTWARE

MICROSOFT

WINDOWS

CURRENT VERSION

DETECT

- b. Select "ADD Binary" and name it as "**ACPIOPTION**".
 - c. Right click and select Modify, add "01" after "0000" to make it "0000 01".
 - d. Save changes.
2. Select "Add New Hardware" under Control Panel. Allow Windows 98 to detect new hardware. (It will find "**ACPI BIOS**" and remove "**Plug and Play BIOS**")
 3. Reboot system.
 4. Clean boot into DOS and run "AOZVHDD.EXE /C /File"

Changing from ACPI to APM

1. Run "Regedit.exe"

- a. Go through the following path

HKEY_LOCAL_MACHINE

SOFTWARE

MICROSOFT

WINDOWS

CURRENT VERSION

DETECT

ACPI OPTION

- b. Right click and select "Modify, change "01" to "02" to make it "0000 02".



Tip: "02" means Windows 98 is ACPI acknowledged but the ACPI function is disabled.

- c. Save changes.

2. Select "Add New Hardware" under Control Panel. Allow Windows 98 to detect new hardware. (It will find "**Plug and Play BIOS**" and **remove "ACPI BIOS"**)
3. Reboot system.
4. Run "Add New Hardware" again and it will find "Advanced Power Management Resource".
5. Click "OK".

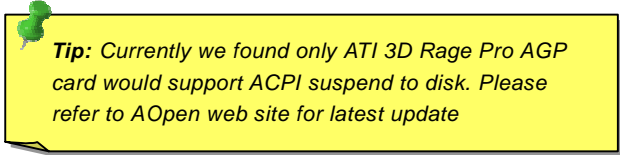

***Tip:** Currently we found only ATI 3D Rage Pro AGP card would support ACPI suspend to disk. Please refer to AOpen web site for latest update*

ACPI Suspend to RAM (STR)

This motherboard supports [ACPI](#) Suspend to RAM function. With this function, you can resume your original work directly from DRAM without going through the Windows 98 booting process and run your application again. Suspend to DRAM saves your current work in the system memory, it is faster than Suspend to Hard Drive but requires power supplied to DRAM, while Suspend to Hard Drive requires no power.

When go into Suspend:

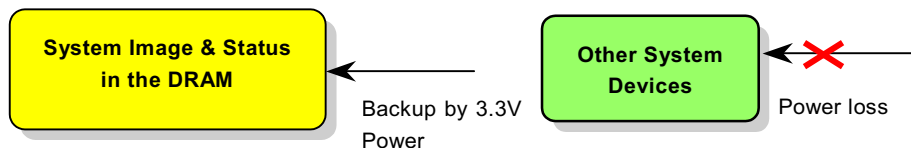

When power-on next time:

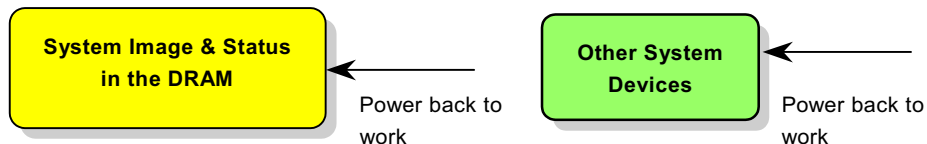

To implement ACPI Suspend to DRAM, please follow the procedures as below:

System Requirement

1. An ACPI OS is required. Currently, Windows 98 is the only choice. Please refer to [ACPI Suspend to Hard Drive](#) of how to setup Windows 98 ACPI mode.
2. The VIA 4 in 1 Driver must have been installed properly.

Procedures

1. Changed the following BIOS settings.

BIOS Setup > Power Management Setup > [ACPI Function](#): Enabled

BIOS Setup > Power Management Setup > [ACPI Suspend Type](#): S3.

2. Go to Control Panel > Power Management. Set "Power Buttons" to "Standby".
3. Press power button or standby button to wake up the system.

AWARD BIOS

System parameters can be modified by going into [BIOS](#) Setup menu, this menu allows you to configure the system parameters and save the configuration into the 128 bytes CMOS area, (normally in the RTC chip or in the main chipset). [To enter to BIOS setup menu](#), press when [POST \(Power-On Self Test\)](#) screen is shown on your monitor.

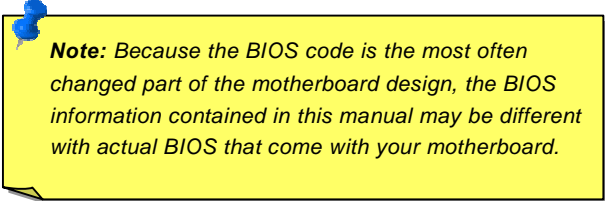

Note: *Because the BIOS code is the most often changed part of the motherboard design, the BIOS information contained in this manual may be different with actual BIOS that come with your motherboard.*

Enter BIOS Setup

 Del

After you finish the setting of jumpers and connect correct cables. Power on and enter the BIOS Setup, press during [POST \(Power-On Self Test\)](#). Choose "[Load Setup Defaults](#)" for recommended optimal performance.

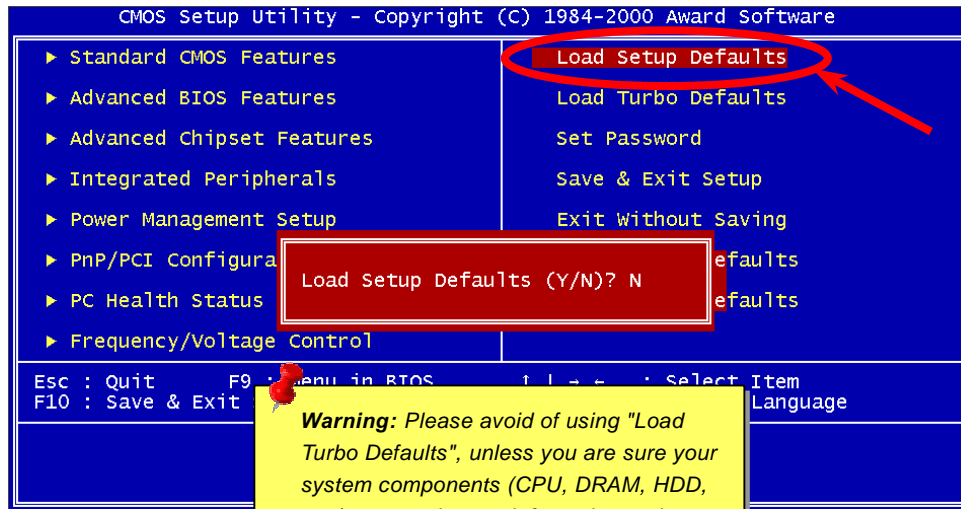

Warning: Please avoid of using "Load Turbo Defaults", unless you are sure your system components (CPU, DRAM, HDD, etc.) are good enough for turbo setting.

Change Language

F3

You can change language by press <F3>. Depends on available BIOS space, the possible languages are English, German, Japanese and Chinese.

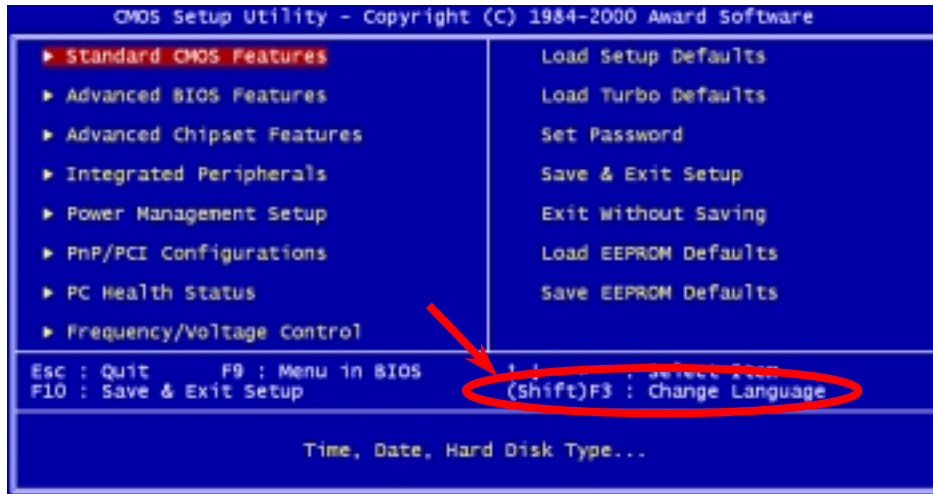

Standard CMOS Features

The "Standard CMOS Features" sets the basic system parameters such as the date, time, and the hard disk type. Use the arrow keys to highlight an item and <PgUp> or <PgDn> to select the value for each item.



```

CMOS Setup Utility - Copyright (C) 1984-2000 Award Software
Standard CMOS Features

Date (mm:dd:yy)      Thu, Sep 21 2000
Time (hh:mm:ss)     16 : 34 : 29

▶ IDE Primary Master
▶ IDE Primary Slave
▶ IDE Secondary Master
▶ IDE Secondary Slave

Drive A              1.44M, 3.5 in.
Drive B              None

Video               EGA/VGA
Halt On             All Errors

Base Memory          640K
Extended Memory     65472K
Total Memory         1024K

| | --:Move  Enter:Select  +/-/PU/PD:Value  F10:Save  ESC:Exit  F1:General Help
F2:Item Help  F3:Language  F5:Previous Values  F6:Setup Defaults  F7:Turbo Defaults
  
```



Standard CMOS Features > Date (mm:dd:yy)

To set the date, highlight the Date parameter. Press <PgUp> or <PgDn> to set the current date. The date format is month, date, and year.

Standard CMOS Features > Time (hh:mm:ss)

To set the time, highlight the Time parameter. Press <PgUp> or <PgDn> to set the current time in hour, minute, and second format. The time is based on the 24-hour military clock.

Standard CMOS Setup> IDE HDD Auto-Detection

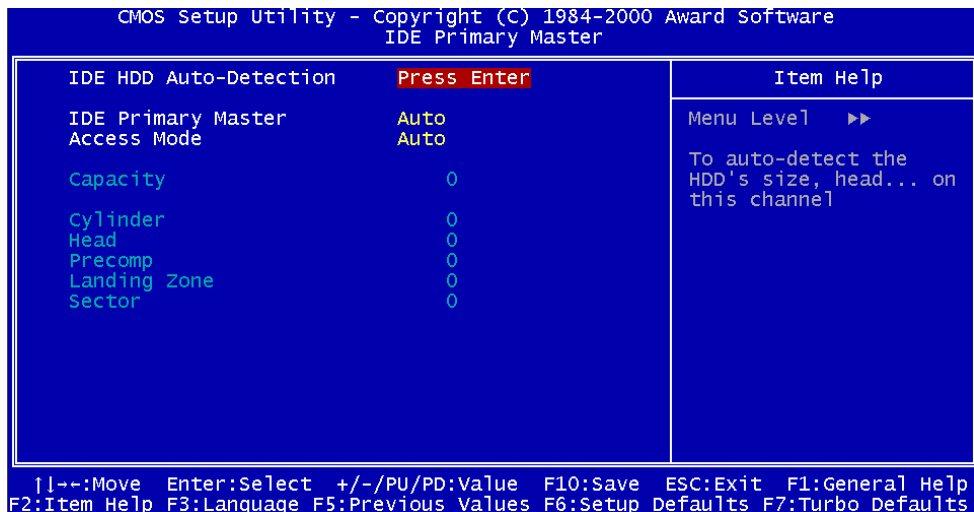

IDE HDD
Auto
Detection

This item lets the system to the HDD's size, head... on this channel.

Standard CMOS Setup > IDE Primary Master/Slave & IDE Secondary Master/Slave

IDE Primary & Slave Master/Slave

Auto (Default)
Manual
None

If you select "Manual", you need to fill in all remaining field, such as Access Mode, Capacity, Cylinder, Head, Precomp, Landing Zone and Sector on this selected item. If the item "Auto" is selected, only "Access Mode" can be set, the others will remain "0". And when the system boot up, system will detect the hard disk and configure it automatically. "None" means there is no device in the channel.

Standard CMOS Setup > IDE Primary Master/Slave & IDE Secondary Master/Slave > Access Mode

Mode

Auto (Default)
CHS
LBA
Large

The enhanced IDE feature allows the system to use a hard disk with a capacity of more than 528MB. This is made possible through the Logical Block Address (LBA) mode translation. The LBA is now considered a standard feature of current IDE hard disk on the market because of its capability to support capacity larger than 528MB. Note that if a HDD is formatted with LBA On, it will not be able to boot with LBA Off.

Tip: For an IDE hard disk, we recommend that you use the "Auto" to enter the drive specifications automatically

Standard CMOS Setup > Drive A/Drive B

Drive A/Drive B

None
360KB 5.25"
1.2MB 5.25"
720KB 3.5"
1.44MB 3.5" (Default)
2.88MB 3.5"

These items select the floppy drive type. The available settings and types supported by the motherboard are listed to the left.

Standard CMOS Setup > Video

Video

EGA/VGA (Default)
CGA40
CGA80
Mono

This item specifies the type of video card in use. The default setting is VGA/EGA. Since current PCs use VGA only, this function is almost useless and may be disregarded in the future.

Standard CMOS Setup > Halt On

Halt On

No Errors

All Errors (Default)

All, But Keyboard

All, But Diskette

All, But Disk/Key

This parameter enables you to control the system stops in case of Power-On Self Test ([POST](#)) error.

Advanced BIOS Features Setup

This screen appears when you select the option "BIOS Features Setup" from the main menu.

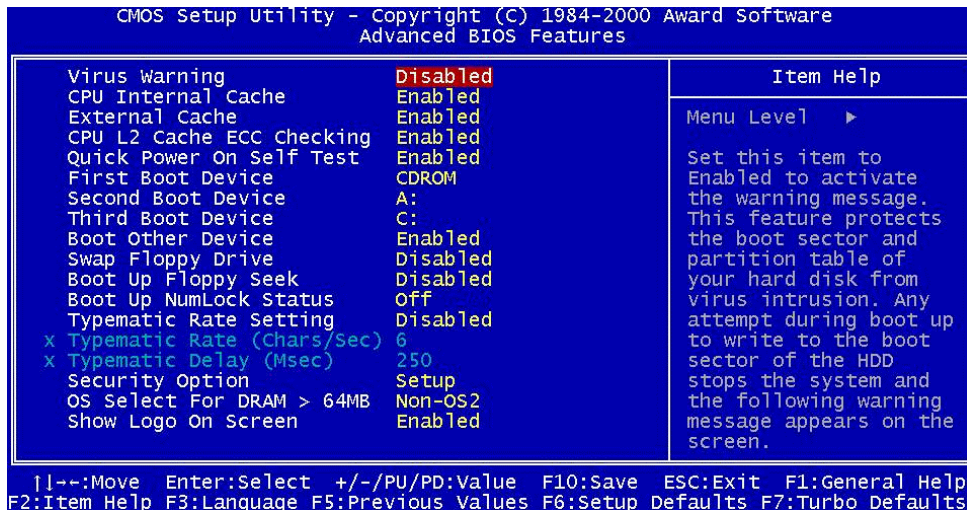

Advanced BIOS Features > Virus Warning

Virus Warning

Enabled

Disabled (Default)

Set this parameter to Enabled to activate the warning message. This feature protects the boot sector and partition table of your hard disk from virus intrusion. Any attempt during boot up to write to the boot sector of the hard disk drive stops the system and the following warning message appears on the screen. Run an anti-virus program to locate the problem.

! WARNING !

Disk Boot Sector is to be modified
Type "Y" to accept write, or "N" to abort write
Award Software, Inc.

Advanced BIOS Features > CPU Internal Cache

CPU Internal Cache

Enabled (Default)
Disabled

Enabling this parameter activates the CPU L1 cache. Disabling the parameter slows down the system. Therefore, we recommend that you leave it enabled unless you are troubleshooting a problem.

Advanced BIOS Features > External Cache

External Cache

Enabled (Default)
Disabled

Enabling this parameter activates the CPU L2 cache. Disabling the parameter slows down the system. Therefore, we recommend that you leave it enabled unless you are troubleshooting a problem.

Advanced BIOS Features > CPU L2 Cache ECC Checking

CPU L2 Cache ECC Checking

Enabled (Default)
Disabled

This item lets you enable or disable L2 Cache [ECC](#) checking.

Advanced BIOS Features > Quick Power On Self Test

Quick Power on Self-test

Enable (Default)
Disabled

This parameter speeds up [POST](#) by skipping some items that are normally checked.

Advanced BIOS Features > First/Second/Third Boot Device

Boot Device

A (**Second Boot Device Default**);
LS-120; C (**Third Boot Device Default**); SCSI;
CDROM (**First Boot Device Default**); D;
E; F; ZIP; LAN;
Disable

This parameter allows you to specify the system boot up search sequence. The hard disk ID are listed below:

C: Primary master
D: Primary slave
E: Secondary master
F: Secondary slave
Zip: IOMEGA ZIP Drive

Advanced BIOS Features > Boot other device

Boot other device

Enabled (Default)

Disabled

This item allows you to boot up the system from other bootable devices.

Advanced BIOS Features > Swap Floppy Drive

Swap Floppy Drive

Enabled

Disabled (Default)

This item allows you to swap floppy drives. For example, if you have two floppy drives (A and B), you can assign the first drive as drive B and the second drive as drive A or vice-versa.

Advanced BIOS Features > Boot Up Floppy Seek

Boot Up Floppy Seek

Enabled

Disabled (Default)

This item can enable tests floppy drives to determine whether they have 40 or 80 tracks.

Advanced BIOS Features > Boot Up NumLock Status

Boot Up NumLock Status

On
Off (Default)

Setting this parameter to On enables the numeric function of the numeric keypad. Set this parameter to Off to disregard the function. Disabling the numeric function allows you to use the numeric keypad for cursor control.

Advanced BIOS Feature > Typematic Rate Setting

Typematic Rate Setting

Enabled
Disabled (Default)

This item lets keystrokes repeat at a rate determine by the keyboard controller. When you enable this function, the typematic rate and typematic delay will be selected.

Advanced BIOS Feature > Typematic Rate (Chars/Sec)

Typematic Rate

6 (Default); 8; 10;
12; 15; 20; 24; 30

This item lets you select the rate at which character repeats when you hold down a key.

Advanced BIOS Feature > Typematic Delay (Msec)

Typematic Delay

250 (Default); 500;
750; 1000

This item lets you select the delay timing before keystroke begin to repeat.

Advanced BIOS Features > Security Option

Security Option

Setup (Default)
System

The **System** option limits access to both the System boot and BIOS setup. A prompt asking you to enter your password appears on the screen every time you boot the system.

The **Setup** option limits access only to BIOS setup.

To disable the security option, select Password Setting from the main menu, don't type anything and just press <Enter>.

Advanced BIOS Features > OS Select For DRAM > 64MB**OS Select For
DRAM > 64MB**

OS2

Non-OS2 (Default)

This item lets you select "OS/2 only" if you are running OS/2 operation system with greater than 64MB of RAM on the system.

Advanced BIOS Features > Show Logo On Screen**Show Logo On
Screen**

Enabled (Default)

Disabled

This item lets you show or hide AOpen logo on the [POST](#) screen.

Advanced Chipset Features Setup

The "Chipset Features Setup" includes settings for the chipset dependent features. These features are related to system performance.

CMOS Setup Utility - Copyright (C) 1984-2000 Award Software
Advanced Chipset Features

Bank 0/1 DRAM Timing	Normal	
Bank 2/3 DRAM Timing	Normal	
Bank 4/5 DRAM Timing	Normal	
Set DRAM Drive Strength by	Auto	
x Delay DRAM Read Latch	1.5 ns	
x Memory Data Drive	6mA	
SDRAM CAS Latency Time	3	
DRAM Clock	PCI CLK x3	
Memory Hole At 15M-16M	Disabled	
P2C/C2P Concurrency	Disabled	
System BIOS Cacheable	Disabled	
Video RAM Cacheable	Disabled	
AGP Aperture Size (MB)	64M	
AGP-4X Mode	Enabled	
AGP Driving Control	Auto	
x AGP Driving Value	DB	
AGP Fast Write	Disabled	
K7 Clock Control	Default	
CPU to PCI Write Buffer	Enabled	

Item Help
Menu Level ▶

Warning: Make sure you fully understand the items contained in this menu before you try to change anything. You may change the parameter settings to improve system performance. However, it may cause your system to be unstable if the setting is not correct for your system configuration.

| |<-:Move Enter:Select +/-/PU/PD:Value F10:Save ESC:Exit F1:General Help
F2:Item Help F3:Language F5:Previous Values F6:Setup Defaults F7:Turbo Defaults

This page is the lower half of Advanced Chipset Features submenu.

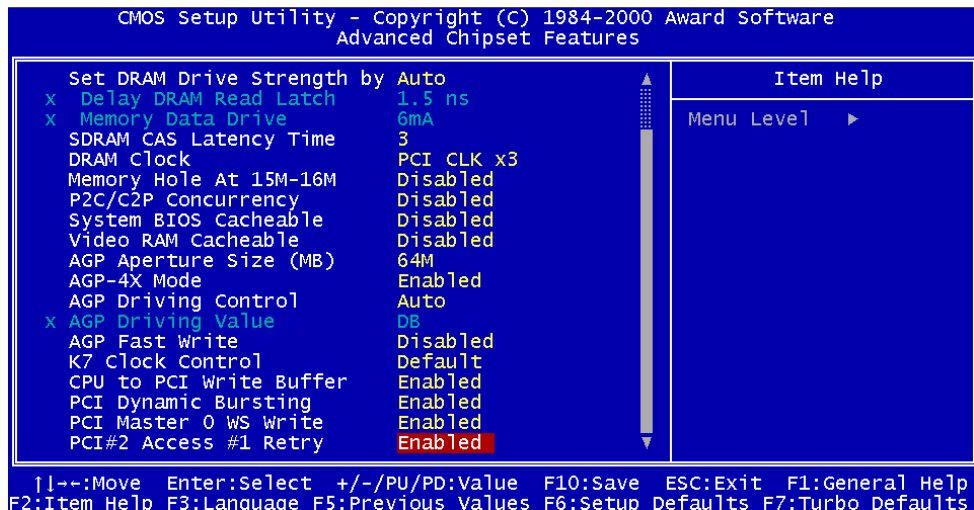

Advanced Chipset Features > Bank 0/1, 2/3, 4/5 DRAM Timing

**Bank 0/1, 2/3, 4/5
DRAM Timing**

Normal (Default)

Turbo

This item controls timing point for latching SDRAM data.
We recommend you leave on the default setting value.

Advanced Chipset Features > Set DRAM Drive Strength by

**Set DRAM Drive
Strength by**

Auto (Default)

Manual

This item lets you change the DRAM drive strength by manual or system auto-detection. If your DIMM module can't work properly, you can set this item to manual for better DRAM compatibility.

Advanced Chipset Features > Delay DRAM Read Latch

Delay DRAM Read Latch

1.5ns (Default)
1.0ns
0.5ns
No Delay

This item allows you to select the DRAM read latch timing. The shorter latch timing means the data can be transfer to memory earlier.

Advanced Chipset Features > Memory Data Drive

Memory Data Drive

6mA (Default)
8mA

This item allows you to select the memory data driving current. Too strong current may cause the data signal reflection.

Advanced Chipset Features > SDRAM CAS Latency Time

SDRAM CAS Latency Time

2
3 (Default)

This option controls the latency between SDRAM read command and the time that the data actually becomes available. If you system has unstable problem, please change the setting from 2 to 3.

Advanced Chipset Features > DRAM Clock

DRAM Clock

PCI CLK x 3 (Default)

PCI LCK x 4 (Only for FSB=100 or 133)

This item allows you selecting DRAM working clock to PCI CLK x 2, PCI CLK x 3 or PCI CLK x 4.

PCI Clock = CPU FSB Clock / Clock Ratio

CPU FSB (MHz)	PCI Clock (MHz)	BIOS Setting	DRAM Clock (MHz)
100	33	PCI CLK x 3	100
		PCI CLK x 4	133
133	33	PCI CLK x 3	100
		PCI CLK x 4	133

Advanced Chipset Features > Memory Hole At 15M-16M

**Memory Hole At
15M-16M**

Enabled

Disabled (Default)

This option lets you reserve system memory area for special ISA cards. The chipset accesses code/data of these areas from the ISA bus directly. Normally, these areas are reserved for memory mapped I/O card.

Advanced Chipset Features > P2C/C2P Concurrency

**P2C/C2P
Concurrency**

Enabled

Disabled (Default)

This item can enable or disable the PCI to CPU/CPU to PCI concurrency.

Advanced Chipset Features > System BIOS Cacheable

**System BIOS
cacheable**

Enabled

Disabled (Default)

When set this item to “**Enabled**”, the contents of the F0000h system memory segment can be read from or written to cache memory. The contents of this memory segment are always copies from the BIOS ROM to system RAM for faster execution.

Advanced Chipset Features > Video RAM Cacheable

**Video RAM
Cacheable**

Enabled

Disabled (Default)

If you set this item to enable, it allows caching of the video BIOS, resulting in better system performance. However, if any program writes to this memory area, a system error may result.

Advanced Chipset Features > AGP Aperture Size (MB)

**AGP Aperture Size
(MB)**

4; 8; 16; 32;

64(Default); 128

This option specifies the amount of system memory that can be used by the [Accelerated Graphic Port \(AGP\)](#).

Advanced Chipset Features > AGP-4X Mode

AGP-4X Mode

Enabled (Default)

Disabled

If your AGP card supports 4x, select Enabled; otherwise, select Disabled.

Advanced Chipset Features > AGP Driving Control

AGP Driving Control

Auto
Manual

This option lets you select AGP driving control to “Auto” or “Manual”.

Advanced Chipset Features > AGP Driving Value

AGP Driving Value

00 ~FF, DA is Default setting.

This option can be selected when you set the “AGP Driving Control” to “Auto”. The value can be set from DA to FF.

Advanced Chipset Features > AGP Fast Write

AGP Fast Write

Disabled (Default)
Enabled

This option allows you to enable or disable the AGP fast write function.

Advanced Chipset Features > K7 Clock Control

K7 Clock Control

Default (Default)

Optimal

This item allows you to select K7 CPU clock control mode. This option only for AMD Athlon K7 CPU, changing this option to set the CPU timing to turbo mode.

Advanced Chipset Features > CPU To PCI Write Buffer

CPU to PCI Write Buffer

Enabled (Default)

Disabled

This item lets you enable or disable CPU to PCI write buffer.

Advanced Chipset Features > PCI Dynamic Bursting

PCI Dynamic Bursting

Enabled (Default)

Disabled

If you enable the PCI dynamic bursting, it can increase data transferring performance.

Advanced Chipset Features > PCI Master 0 WS Write**PCI Master 0 WS
Write**

Enabled (Default)

Disabled

This option allows you to enable PCI master writing the data with no waiting.

Advanced Chipset Features > PCI#2 Access #1 Retry**PCI#2 Access #1
Retry**

Enabled (Default)

Disabled

This item lets you enable or disable the PCI#2 sending a retry signal to request PCI#1 stopping the data transferring.

Integrated Peripherals

The following screen appears if you select the option "Integrated Peripherals" from the main menu. This option allows you to configure the I/O features.

```

CMOS Setup Utility - Copyright (C) 1984-2000 Award Software
Integrated Peripherals

OnChip Primary PCI IDE Enabled
OnChip Secondary PCI IDE Enabled
IDE Prefetch Mode Enabled
IDE Primary Master PIO Auto
IDE Primary Slave PIO Auto
IDE Secondary Master PIO Auto
IDE Secondary Slave PIO Auto
IDE Primary Master UDMA Auto
IDE Primary Slave UDMA Auto
IDE Secondary Master UDMA Auto
IDE Secondary Slave UDMA Auto
Init Display First AGP
AC PWR Auto Recovery Off
USB Controller Enabled
USB Keyboard Support Disabled
IDE HDD Block Mode Enabled
Onboard FDD Controller Enabled
Onboard Serial Port 1 Auto
Onboard Serial Port 2 Auto

Item Help
Menu Level ▶
This parameter lets
you enable or disable
the IDE device
connected to the IDE
connector.

↑
↓

| |←:Move Enter:Select +/-/PU/PD:Value F10:Save ESC:Exit F1:General Help
F2:Item Help F3:Language F5:Previous Values F6:Setup Defaults F7:Turbo Defaults
  
```

This page is the lower half of Integrated Peripherals submenu.

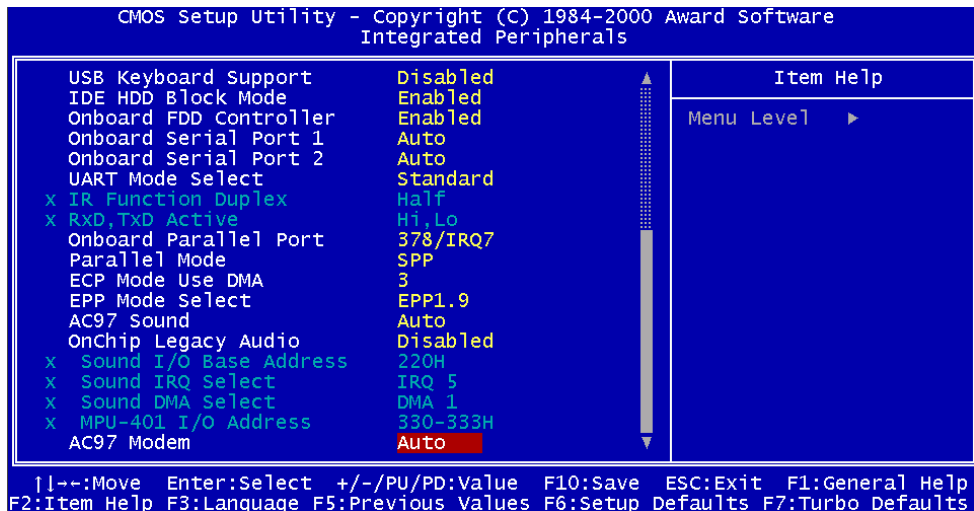

Integrated Peripherals > OnChip Primary/Secondary PCI IDE

**OnChip
Primary/Secondary
PCI IDE**

Enabled (Default)

Disabled

This parameter lets you enable or disable the IDE device connected to the primary/secondary IDE connector.

Integrated Peripherals > IDE Prefetch Mode

IDE Prefetch Mode

Enabled

Disabled (Default)

This item is used to enable and disable IDE prefetch mode.

Integrated Peripherals > Primary Master/Slave PIO & Secondary Master/Slave PIO

Primary Master/Slave & Secondary Master/Slave PIO

Auto (Default)
Mode 1
Mode 2
Mode 3
Mode 4

Setting this item to **Auto** activates the HDD speed auto-detect function. The PIO mode specifies the data transfer rate of HDD. For example: mode 0 data transfer rate is 3.3MB/s, mode 1 is 5.2MB/s, mode 2 is 8.3MB/s, mode 3 is 11.1MB/s and mode 4 is 16.6MB/s. If your hard disk performance becomes unstable, you may manually try the slower mode.

Integrated Peripherals > Primary Master/Slave UDMA & Secondary Master/Slave UDMA

Primary Master/Slave & Secondary Master/Slave UDMA

Auto (Default)
Disable

This item allows you to set the [Ultra DMA33](#) or [Ultra DMA66](#) mode supported by the hard disk drive connected to your IDE connector.



Integrated Peripherals > Init Display First

Init Display First

PCI

AGP (Default)

If you installed a PCI VGA card and an [AGP](#) card at the same time, this item lets you decide which one is the initial display card.

Integrated Peripherals > AC PWR Auto Recovery

AC PWR Auto Recovery

On

Off (Default)

Former Status

A traditional ATX system should remain at power off stage when AC power resume from power failure. This design is inconvenient for a network server or workstation, without an UPS, that needs to keep power-on. The system will remain power-off if you select "Off". Selecting "On" to enable system automatically power-on after power failure. If you select "Former Status", the system will power-on or power-off based on the last state.

Integrated Peripherals > USB Controller

USB Controller

Enabled (Default)

Disable

This item can let you enable or disable the [USB](#) controller.

Integrated Peripherals > USB Keyboard Support

USB Keyboard Support

Enabled

Disable (Default)

This item lets you enable or disable the USB keyboard driver within the on-board BIOS. The keyboard driver simulates legacy keyboard command and let you use USB keyboard during POST or after boot if you don't have the USB driver in the operation system.

Note: You cannot use both USB driver and USB legacy keyboard at the same time. Disable "USB Keyboard Support" if you have USB driver in the operation system. Turn off the system, set the External Controller to "**Rescue**" to read from rescue ROM.

- Boot the system and set the switch back to "**Normal**".
- Follow the BIOS upgrade procedure to rehabilitate BIOS.
- Reboot the system, and you should be able to back to normal.

Integrated Peripherals > IDE HDD Block Mode

IDE HDD Block Mode

Enabled (Default)

Disabled

If your IDE hard drive supports "Block Mode", you can select **Enabled** for automatic detection of the optimal number of block read/write per sector the drive can support.

Integrated Peripherals > Onboard FDD Controller

**Onboard FDC
Controller**

Enabled (Default)

Disabled

Setting this parameter to **Enabled** allows you to connect your floppy disk drives to the onboard floppy disk connector instead of a separate controller card. Change the setting to Disabled if you want to use a separate controller card.

Integrated Peripherals > Onboard Serial Port 1 & Port 2

Onboard Serial Port 1 & Port 2

Auto (Default)

3F8/IRQ4

2F8/IRQ3

3E8/IRQ4

2E8/IRQ3

Disabled

This item allows you to assign address and interrupt for the board serial port.

Note: If you are using network card, make sure that the IRQ do not conflict.

Integrated Peripherals > UART Mode Select

UART Mode Select

Standard (Default)

HPSIR

ASKIR

This item is configurable only if the "Onboard Serial Port 2" is enabled. This allows you to specify the mode of serial port2.

Standard

Sets serial port 2 to operate in normal mode. This is the default setting.

HPSIR

This setting allows infrared serial communication at a maximum baud rate of 115K baud.

SASKIR

This setting allows infrared serial communication at a maximum baud rate of 19.2K baud.

Integrated Peripherals > IR Function Duplex**IR Function Duplex**

Half (Default)

Full

This item is used to select full duplex or half duplex of IR function. Normally, full duplex is faster, because it transmits data bi-direction at the same time.

Integrated Peripherals > RxD, TxD Active

RxD, TxD Active

No, Yes (Default)

Yes, No

Yes, Yes

No, No

This item is used to select RxD (Receive Data) and TxD (Transmit Data) mode for UART, for instance, IR device, modem, etc. Normally, we suggest you keep the default setting. Please see the documentation that comes with your device.

Integrated Peripherals > Onboard Parallel Port

Onboard Parallel Port

3BC/IRQ7

378/IRQ7 (Default)

278/IRQ5

Disabled

This item controls the onboard parallel port address and interrupt.

Note: If you are using an I/O card with a parallel port, make sure that the addresses and IRQ do not conflict.

Integrated Peripherals > Parallel Mode

Parallel Mode

Normal (Default)

EPP

ECP

ECP/EPP

This item lets you set the parallel port mode. The mode options are Normal (SPP, Standard and Bi-direction Parallel Port), EPP (Enhanced Parallel Port) and ECP (Extended Parallel Port).

SPP (Standard and Bidirection Parallel Port)

SPP is the IBM AT and PS/2 compatible mode.

EPP (Enhanced Parallel Port)

EPP enhances the parallel port throughput by directly writing/reading data to/from parallel port without latch.

ECP (Extended Parallel Port)

ECP supports DMA and RLE (Run Length Encoded) compression and decompression.

Integrated Peripherals > ECP Mode Use DMA

ECP Mode Use DMA

3 (Default)

1

This item lets you set the DMA channel of ECP mode.

Integrated Peripherals > Parallel Port EPP Type

Parallel Port EPP Type

EPP1.7

EPP1.9 (Default)

This item lets you select EPP mode protocol.

Integrated Peripherals > AC 97 Sound

AC 97 Sound

Auto (Default)

Disable

This item can let system auto-detection or disable the on-board AC 97 Audio CODEC.

Integrated Peripherals > Onboard Legacy Audio

**Onboard Legacy
Audio**

Enabled (Default)

Disable

This item lets you enable or disable on-board audio legacy.

Integrated Peripherals > SB I/O Base Address

**SB I/O Base
Address**

220H (Default)

240H

260H

280H

This item lets you select the on-board audio I/O base address.

Integrated Peripherals > SB IRQ Select

SB IRQ Select

IRQ 5 (Default)

IRQ 7

IRQ 9

IRQ 10

This item lets you select the on-board audio IRQ

Integrated Peripherals > SB DMA Select

SB DMA SelectDMA 0; DMA 1
(Default); DMA 2;
DMA 3

This item lets you select the on-board audio DMA.

Integrated Peripherals > MPU-401 I/O Address

**MPU-401 I/O
Address**

330-333H (Default)
300-303H
310-313H
320-323H

This item lets you select the MIDI port I/O address.

Integrated Peripherals > AC 97 Modem

AC 97 Modem

Auto (Default)
Disable

This item can let system auto-detection or disable the AC 97 modem function. If you disable it, the [AMR](#) modem card can't work properly.

Power Management Setup

The Power Management Setup screen enables you to control the motherboard green features. See the following screen.

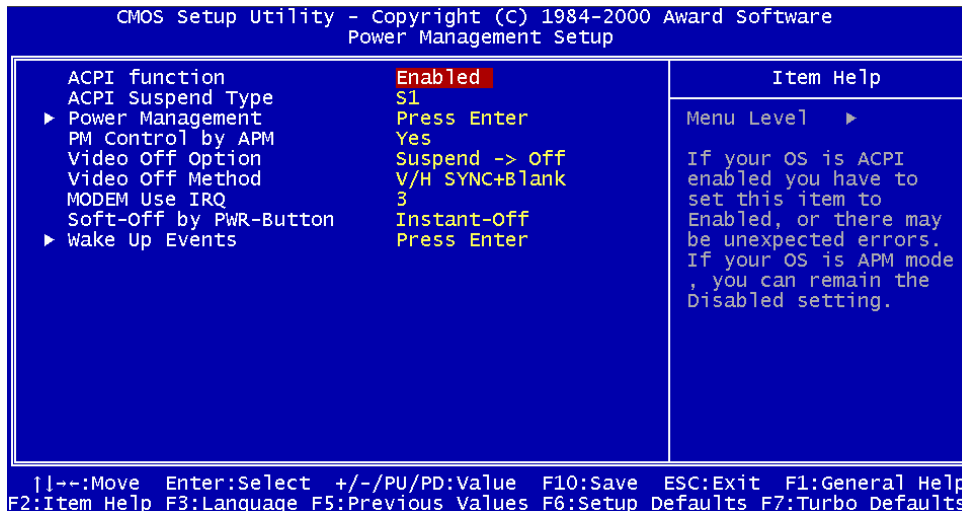

Power Management > ACPI Function

ACPI Function

Enabled (Default)

Disabled

If your OS is ACPI enabled you have to set this item to Enabled, or there may be unexpected errors. If your OS is APM mode, you can remain the Disabled setting.

Power Management Setup > ACPI Suspend Type

ACPI Suspend Type

S1

S3

This function allows you to select suspend types. S1 is Power On Suspend and S3 is Suspend to RAM.

Power Management > PM Timers

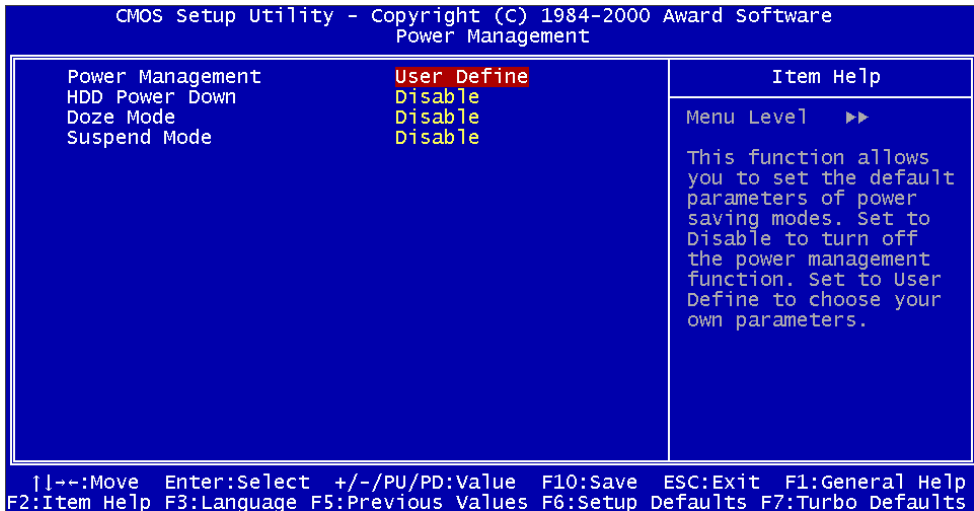

Power Management > PM Timers > Power Management

Power Management

Max Saving
 Mix Saving
 User Define (Default)
 Disabled

This function allows you to set the default parameters of power-saving modes. Set to **Disable** to turn off power management function. Set to **User Define** to choose your own parameters.

Mode	Doze	Suspend
Min Saving	1 hour	1 hour
Max Saving	1 min	1 min

Power Management > PM Timers > HDD Power Down

HDD Power Down

Disabled (Default)
 1min to 15 min

This option lets you specify the IDE HDD idle time before the device enters the power down state.

Power Management > Power Timers > Doze Mode

Doze Mode

Disabled (Default), 1 min, 2 min, 4 min, 8 min, 12 min, 20 min, 30 min, 40 min, 1 hour

This item lets you set the period of time after which the system enters into Doze mode. The system activity (or event) is detected by monitoring the IRQ signals or other events (such as I/O).

Power Management > Power Timers > Suspend Mode

Suspend Mode

Disabled (Default), 1 min, 2 min, 4 min, 8 min, 12 min, 20 min, 30 min, 40 min, 1 hour

This item lets you set the period of time after which the system enters into Suspend mode. The Suspend mode can be **Suspend to RAM** or **Suspend to Hard Drive**, selected by "[ACPI Suspend Type](#)".

Power Management > PM Controlled by APM

PM Controlled by APM

Yes (Default)
No

If "Max Saving" is selected, you can turn on this item, transfer power management control to APM (Advanced Power Management) and enhance power saving function. For example, stop CPU internal clock.

Power Management > Video Off Option

Video Off Option

Suspend → Off (Default)

All Modes → Off

Always On

This item lets you to decide whether the video is off in the suspend mode.

Power Management > Video Off Method

Video Off Method

V/H SYNC + Blank (Default)

DPMS Support

Blank Screen

This determines the way that monitor is off. Blank Screen writes blanks to video buffer. V/H SYNC+Blank allows BIOS to control VSYNC and HSYNC signals. This function applies only for DPMS (Display Power Management Standard) monitor. The DPMS mode uses DPMS function provided by VGA card.

Power Management > Modem Use IRQ

Modem Use IRQ

3 (Default); 4; 5; 7; 9;
10; 11; NA

This item lets you set an IRQ for the modem.

Power Management > Soft-off By PWR-Button

Soft-off By PWR-Button

Instant-Off (Default)

Delay 4 Sec

This is a specification of ACPI and supported by hardware. When **Delay 4 sec** is selected, the soft power switch on the front panel can be used to control power on, suspend and off. If the switch is pressed for less than 4 seconds during the system power-on, the system will go into suspend mode. If the switch is pressed for longer than 4 seconds, the system will be power-off. The default setting is **Instant-Off**. If Instant-Off is selected the soft power switch is only used to control power-on and power-off. Hence, there is no need to press it for 4 seconds and there is no suspend.

Power Management > Wake Up Events

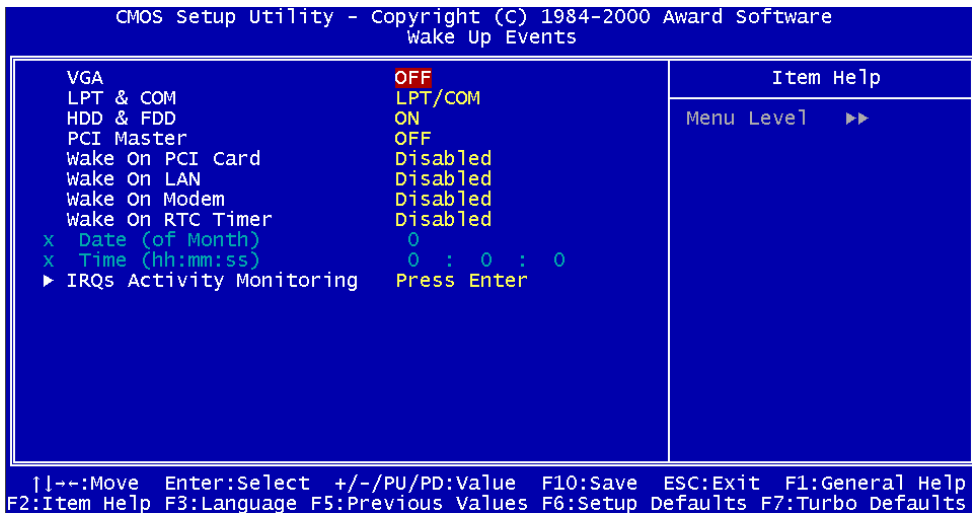

Power Management > Wake Up Events > VGA**VGA**

Off (Default)

On

This item can enable or disable the detection of VGA activities for power down state transition.

Power Management > Wake Up Events > LPT & COM**LPT & COM**

LPT/COM (Default)

NONE

LPT

COM

This item can enable or disable the detection of LPT/COM port activities for power down state transition.

Power Management > Wake Up Events > HDD & FDD**HDD & FDD**

On (Default)

Off

This item can enable or disable the detection of HDD/FDD activities for power down state transition.

Power Management > Wake Up Events > PCI Master**PCI Master**

Off (Default)

On

This item can enable or disable the detection of PCI Master activities for power down state transition.

Power Management > Wake Up Events > Wake On PCI Card**Wake On PCI Card**

Disabled (Default)

Enabled

This item lets you specify enable or disable Wake On PCI Card function.

Power Management > Wake Up Events > Wake On LAN**Wake On LAN**

Disabled (Default)

Enabled

This item lets you specify enable or disable Wake On LAN function.

Power Management > Wake Up Events > Wake On Modem**Wake On Modem**

Disabled (Default)

Enabled

This item lets you specify enable or disable Wake On Modem function.

Power Management > Wake Up Events > Wake On RTC Timer**Wake On RTC Timer**

Disabled (Default)

Enabled

This item lets you specify enable or disable Wake On RTC Timer function.

Power Management > Wake Up Events > Date (of Month)**Date (of Month)**

0 to 31

This item is displayed when you enable the “**Wake On RTC Timer**” option. Here you can specify what date you want to wake up the system. For example, setting to 15, the system will wake up on the 15th day of every month.

Power Management > Wake Up Events > Time (hh:mm:ss)**Time (hh:mm:ss)**

hh:mm:ss

This item is displayed when you enable the RTC Wake Up Timer option. Here you can specify what time you want to wake up the system.

Power Management > Wake Up Events > IRQs Activity Monitoring

```

CMOS Setup Utility - Copyright (C) 1984-2000 Award Software
IRQs Activity Monitoring

```

		Item Help
Primary INTR	ON	
IRQ3 (COM 2)	Enabled	
IRQ4 (COM 1)	Enabled	
IRQ5 (LPT 2)	Enabled	
IRQ6 (Floppy Disk)	Enabled	
IRQ7 (LPT 1)	Enabled	
IRQ8 (RTC Alarm)	Disabled	
IRQ9 (IRQ2 Redir)	Disabled	
IRQ10 (Reserved)	Disabled	
IRQ11 (Reserved)	Disabled	
IRQ12 (PS/2 Mouse)	Enabled	
IRQ13 (Coprocessor)	Disabled	
IRQ14 (Hard Disk)	Enabled	
IRQ15 (Reserved)	Disabled	

Menu Level >>>

These items enable or disable the detection of IDE, floppy, serial, parallel and PCI IRQ activities for power down state transition.

```

[ ]--:Move  Enter:Select  +/-/PU/PD:Value  F10:Save  ESC:Exit  F1:General Help
F2:Item Help  F3:Language  F5:Previous Values  F6:Setup Defaults  F7:Turbo Defaults

```

IRQs Activity Monitoring

IRQ3 (COM 2)

IRQ4 (COM 1)

IRQ5 (LPT 2)

IRQ6 (Floppy Disk)

IRQ7 (LPT 1)

IRQ8 (RTC Alarm)

IRQ9 (IRQ2 Redir)

IRQ10 (Reserved)

IRQ11 (Reserved)

IRQ12 (PS/2 Mouse)

IRQ13 (Coprocessor)

IRQ14 (Hard Disk)

IRQ15 (Reserved)

These items can enable or disable the detection of devices activities by IRQs for power down state transition.

PNP/PCI Configuration Setup

The [PNP/PCI Configuration Setup](#) allows you to configure the PCI devices installed in your system. The following screen appears if you select the option "PNP/PCI Configuration Setup" from the main menu.

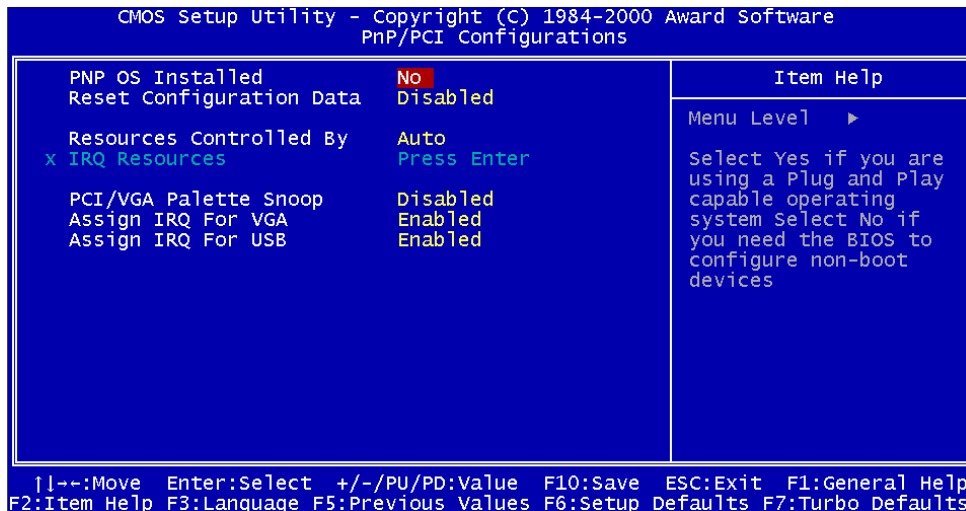

PNP/PCI Configuration > PnP OS Installed

PnP OS Installed

Yes
No (Default)

Normally, the PnP resources are allocated by BIOS during [POST](#) (Power-On Self Test). If you are using a [PnP](#) operating system (such as Windows 95), set this item to `Yes` to inform BIOS to configure only the resources needed for booting (VGA/IDE or SCSI). The rest of system resources will be allocated by PnP operating system.

PNP/PCI Configuration > Reset Configuration Data

Reset Configuration Data

Enabled
Disabled (Default)

In case conflict occurs after you assign the IRQs or after you configure your system, you can enable this function, allow your system to automatically reset your configuration and reassign the IRQs, DMAs, and I/O address.

PNP/PCI Configuration > Resources Controlled By

Resources Controlled by

Auto (Default)

Manual

Setting this option to Manual allows you to individually assign the IRQs and DMAs to the ISA and PCI devices. Set this to **Auto** to enable the auto-configuration function.

PNP/PCI Configuration > IRQ Resource

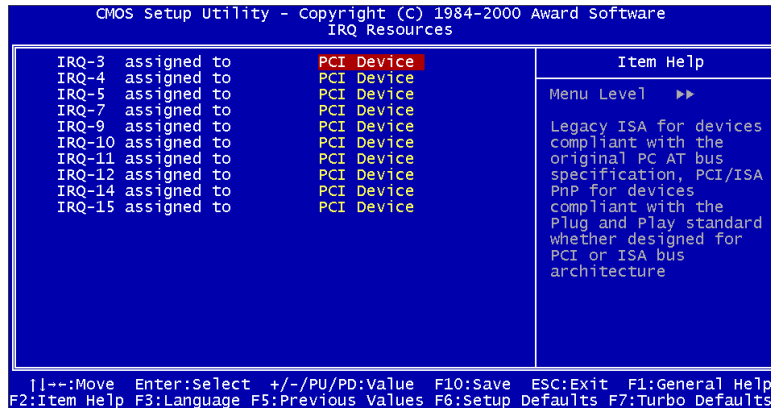

PNP/PCI Configuration > IRQ Resource > IRQ 3, 4, 5, 7, 9, 10, 11, 12, 14, 15 assigned to

IRQ 3, 4, 5, 7, 9, 10,
11, 12, 14, 15
assigned to

PCI Device (Default)

Reserved

When resources are controlled manually, assign each system interrupt a type, depending on the type of device using the interrupt.



PNP/PCI Configuration > PCI/VGA Palette Snoop

PCI/VGA Palette Snoop

Enabled

Disabled (Default)

Enabling this item informs the PCI VGA card to keep silent (and to prevent conflict) when palette register is updated (i.e., accepts data without responding any communication signals).

This is useful only when two display cards use the same palette address and plugged in the PCI bus at the same time (such as MPEG or Video capture card). In such case, PCI VGA is silent while MPEG/Video capture card is set to function normally.

PNP/PCI Configuration > Assign IRQ For VGA

Assign IRQ For VGA

Enabled (Default)

Disabled

In case conflict occurs after you assign the IRQs or after you configure your system, you can enable this function, allow your system to automatically reset your configuration and reassign the IRQs, DMAs, and I/O address.

PNP/PCI Configuration > Assign IRQs For USB**Assign IRQ For USB**

Enabled (Default)

Disabled

In case conflict occurs after you assign the IRQs or after you configure your system, you can enable this function, allow your system to automatically reset your configuration and reassign the IRQs, DMAs, and I/O address.

PC Health Status

As a hardware monitor chip built-in the **VIA VT82C686B Super South Bridge**, BIOS will automatically detect system health parameters such as CPU temperature, CPU fan speed, CPU voltage and voltage on the motherboard. Hence, from this data, the healthy status of system will be showed.

```
CMOS Setup Utility - Copyright (C) 1984-2000 Award Software
PC Health Status

Current CPU Temp.
Current System Temp.
Current CPUFAN Speed
Current CPUFAN Speed
Vcore
3.3V
5V
12V

Item Help
Menu Level1 ▶

↑|←:Move Enter:Select +/-/PU/PD:Value F10:Save ESC:Exit F1:General Help
F2:Item Help F3:Language F5:Previous Values F6:Setup Defaults F7:Turbo Defaults
```

Frequency/Voltage Control

This option allows you to configure the CPU [Front Side Bus \(FSB\)](#) frequency and ratio.

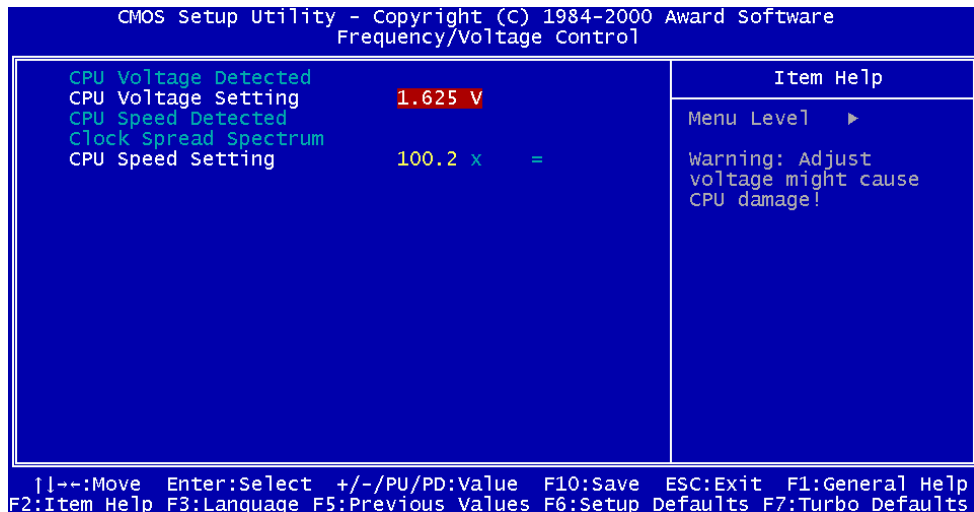

Frequency/Voltage Control > CPU Voltage Detected

**CPU Voltage
Detected**

This item provides you current CPU working voltage.

Frequency/Voltage Control > CPU Voltage Setting

CPU Voltage Setting
1.10V to 1.85V

This item allows you modify the CPU core voltage (Vcore).



Warning: The CPU voltage setting just designed for overclocker. If you are not, we recommend you do not change the default setting value.

Frequency/Voltage Control > CPU Speed Detected

CPU Speed Detected

This item provides you current CPU working frequency.

Frequency/Voltage Control > Clock Spread Spectrum

Clock Spread Spectrum

Enabled (Default)
Disabled

This item lets you enable or disable the spread spectrum modulate.

Frequency/Voltage Control > CPU Speed Setting

CPU Speed Setting

FSB clock:
100-120MHz
124-166MHz

This item allows you modify the CPU FSB clock and ratio.

$\text{FSB} \times \text{Ratio} = \text{CPU clock}$

Notes: If CPU speed detected does not match the CPU speed setup, it is probably caused by the CPU has a fixed FSB clock or ratio.

Warning: If you fail to reboot the system, please press <Home> key first and then press **Reset Button** at the same time.

Load Setup Defaults

The "Load Setup Defaults" option loads optimized settings for optimum system performance. Optimal settings are relatively safer than the Turbo settings. **All the product verification, compatibility/reliability test report and manufacture quality control are based on "Load Setup Defaults"**. We recommend use this settings for normal operation. "Load Setup Defaults" is not the slowest setting for this motherboard. If you need to verify an unstable problem, you may manually set the parameter in the "[Advanced BIOS Features](#)" Setup and "[Advanced Chipset Features](#)" Setup to get slowest and safer setting.

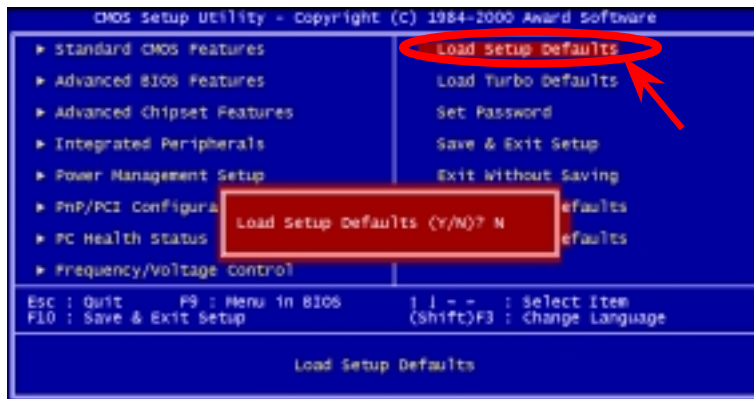

Load Turbo Defaults

The "Load Turbo Defaults" option gives better performance than "Load Setup Defaults". It is provided for the convenience of power user who wants to push the motherboard to get better performance. Turbo setting does not go through all the detail reliability and compatibility test, it is tested only with limited configuration and loading (for example, a system that contains only a VGA card and two DIMMs). **Use Turbo setting only when you fully understand the items in Chipset Setup menu.** The performance improvement of Turbo setting is normally around 3% to 5%, depending on the chipset and the application.

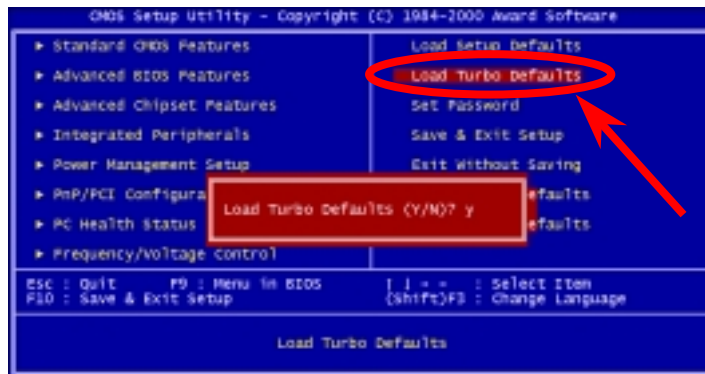

Set Password

Password prevents unauthorized use of your computer. If you set a password, the system prompts for the correct password before boot or access to Setup.

To set a password:

1. At the prompt, type your password. Your password can be up to 8 alphanumeric characters. When you type the characters, they appear as asterisks on the password screen box.
2. After typing the password, press.
3. At the next prompt, re-type your password and press again to confirm the new password. After the password entry, the screen automatically reverts to the main screen.

To disable the password, just press <Enter> key when prompted to enter new password. The screen displays a message confirming that the password has been disabled.

Save & Exit Setup

This function automatically saves all CMOS values before leaving Setup.

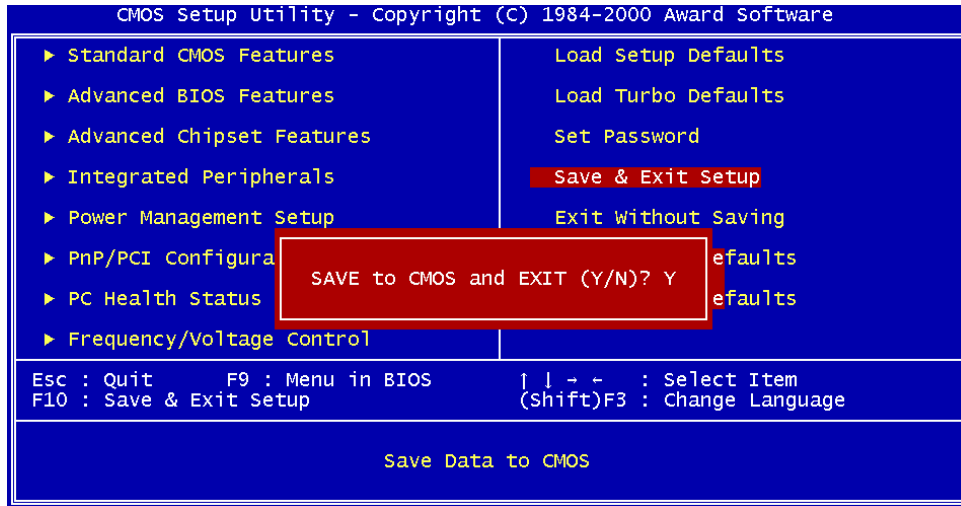

Exit without Saving

Use this function to exit Setup without saving the CMOS value changes. Do not use this option if you want to save the new configuration.

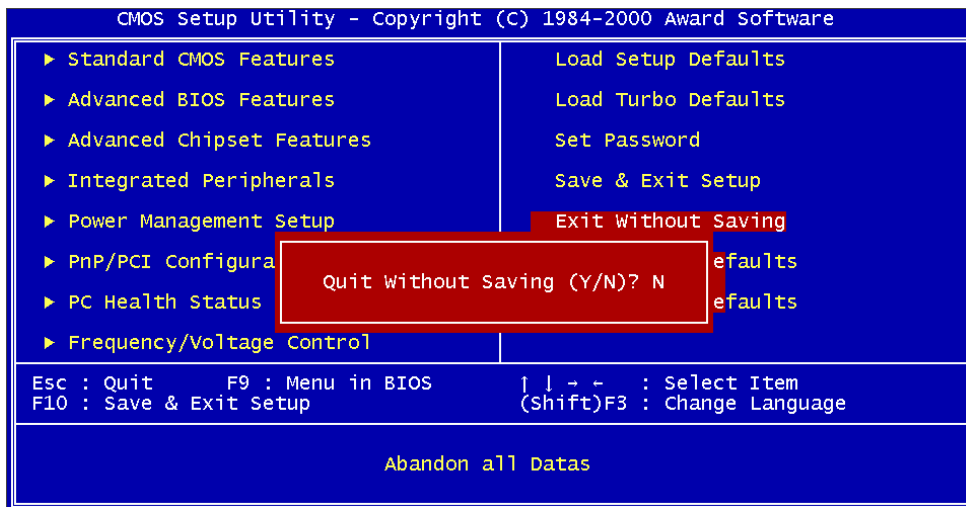

Load EEPROM Default

Except "Load Setup Default" and "Load Turbo Default", you may also use "Save EEPROM Default" to save your own settings into [Flash ROM](#), and reload by using this item.

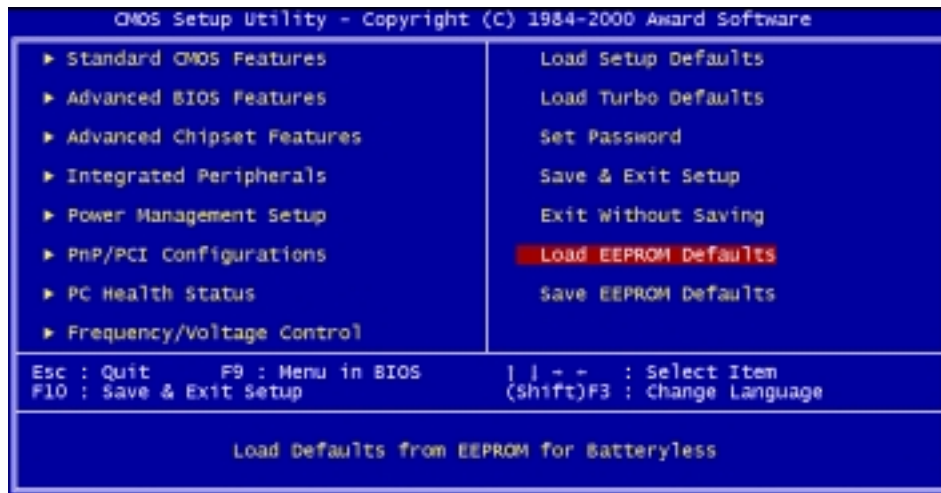

Save EEPROM Default

You may use this item to save your own settings into [Flash ROM](#). Then, if the data in CMOS is lost or you forget the previous settings, you may use "Load EEPROM Default " to reload.

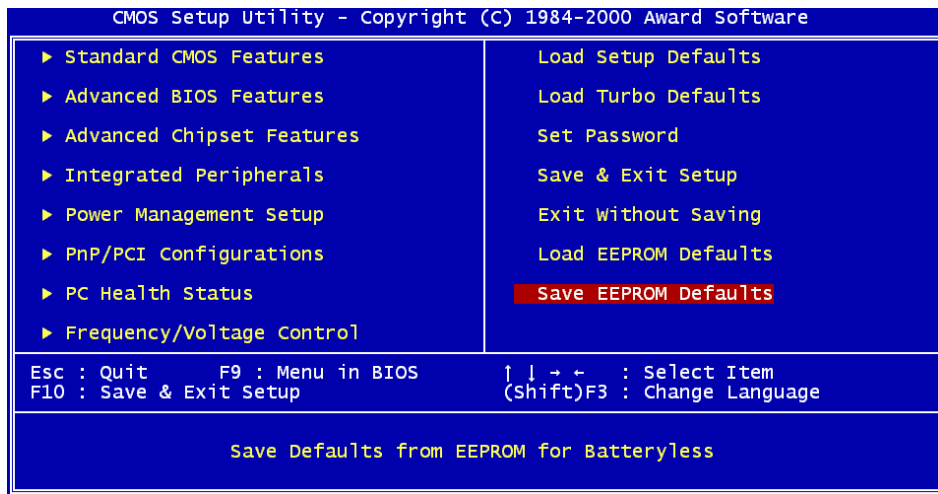

BIOS Upgrade

By flashing your motherboard, you agree to accept the possibility of BIOS flash failure. If your motherboard is working and is stable, and there are no major bugs that were fixed by a latter BIOS revision, we recommend that you DO NOT try to upgrade your BIOS.

By doing so, you are taking a risk of BIOS flash failure. If you indeed intent on upgrading, PLEASE BE SURE to use the right BIOS revision for the right motherboard model.

AOpen Easy Flash is a little different than traditional flash method. The [BIOS](#) binary file and flash routine are linked together and you simply run a single commend to complete the flash process.



Caution: AOpen Easy Flash BIOS programs are designed to be compatible with the Award BIOS. At the date of this note, AOpen Easy Flash BIOS programs are not available for AMI BIOS. AMI BIOS appears mostly only on old 486 boards and some early Pentium boards. Please be sure to view the README compressed inside the BIOS package before upgrading, and follow upgrade instructions carefully. This will minimize the chance of flash failures.

Below are the steps for easy flashing procedures: (applies for Award BIOS ONLY)

1. Download new BIOS upgrade [zip](#) file from AOpen's web site.
For example, AX34PII102.ZIP.
2. Run shareware PKUNZIP (<http://www.pkware.com/>) which supports miscellaneous operation systems to extract the binary BIOS file and the flash utility.
Or Winzip (<http://www.winzip.com/>) in Windows environment.
3. Save the unzipped file into a bootable floppy disk.
For example, AX34PII102.BIN & AX34PII102.EXE
4. Reboot the system to DOS mode without loading any memory handler (such as EMM386) or device driver. It needs around 520K free memory spaces.
5. Execute A:> AX34PII102 and the program will do the rest of it.

DO NOT turn off the power during FLASH PROCESS until you are asked to!!



6. Reboot system and press to [enter BIOS setup](#), Choose "[Load Setup Defaults](#)", then "[Save & Exit Setup](#)". Done!



Warning: The new BIOS upgrade will permanently replace your original BIOS's settings and PnP information when flashing. You may need to reconfigure your BIOS setting and re-install Win95/Win98 as well as your add-on cards, so that your system can go back to work as normal.

Overclocking

As a leading manufacturer in motherboard industry, AOpen always listens to what customers want and develop products to fit different user's requirements. Reliability, compatibility, leading technology and friendly features are our basic goals when designing motherboards. Other than above mentioned design criteria, there are power users who are always seeking to push the limitation of the system performance by overclocking which we call them "Overclocker".

This section is dedicated to overclockers.

This high performance motherboard is designed for maximum **100MHz** CPU bus clock. But it comes with clock generator of **166MHz** when we design it to accommodate future CPU bus clock. Our lab test results shown that **166MHz** is achievable when proper setting and qualified components were presented, we feel quite comfortable overclocking to **166MHz**. Not only that, this motherboard has full-range (CPU core voltage) settings and an option to adjust CPU core voltage. The CPU clock ratio can be up to 12.5X that supports almost all of Athlon/Duron CPUs in the future and provides flexibility for overclockers. For your reference, the following configurations are what we feel comfortable at **166MHz** bus clock.

But not guaranty. 😊



Warning: *The design of this product follows CPU and chipset vendor's design guideline. Any attempts to push beyond product specification are not recommended and you are taking your own risk to damage your system or important data. Before doing overclocking, you must make sure your components are able to tolerate such abnormal setting, especially CPU, DRAMs, hard disks, and AGP VGA cards.*



Tip: *Note that overclocking may also cause thermal problem. Please make sure that the cooling fan and the heatsink were adequate to dissipate excessive heat that's generated by overclocking the CPU.*

VGA Card & Hard Disk

VGA and HDD is key components for overclocking, for your reference, the following list are what have been successful overclocked in our lab. Please note that AOpen can not guaranty they can be successful overclocked again. Please check the **Available Vendor List (AVL)** by link to our official website.

VGA: <http://www.aopen.com.tw/tech/report/overclk/mb/vga-oc.htm>

HDD: <http://www.aopen.com.tw/tech/report/overclk/mb/hdd-oc.htm>

Glossary

AC97

Basically, AC97 specification separates sound/modem circuit to two parts, digital processor and a [CODEC](#) for analog I/O they are linked by AC97 link bus. Since digital processor can be put into motherboard main chipset, the cost of sound/modem onboard solution can be reduced.

ACPI (Advanced Configuration & Power Interface)

ACPI is the power management specification of PC97 (1997). It intends to save more power by taking full control of power management to operating system and bypass [BIOS](#). The chipset or super I/O chip needs to provide standard register interface to operating system (such as Windows 98). This is a bit similar as the [PnP](#) register interface. ACPI defines ATX momentary soft power switch to control the power state transition.

AGP (Accelerated Graphic Port)

AGP is a bus interface targeted for high-performance 3D graphic. AGP supports only memory read/write operation and single-master single-slave one-to-one only. AGP uses both rising and falling edge of the 66MHz clock, for 2X AGP, the data transfer rate is $66\text{MHz} \times 4\text{byte} \times 2 = 528\text{MB/s}$. AGP is now moving to 4X mode, $66\text{MHz} \times 4\text{byte} \times 4 = 1056\text{MB/s}$. AOpen is the first company to support 4X AGP motherboards by both AX6C (Intel 820) and MX64/AX64 (VIA 694x), started from Oct 1999.

AMR (Audio/Modem Riser)

The [CODEC](#) circuit of AC97 sound/modem solution can be put on motherboard or put on a riser card (AMR card) that connects to motherboard through AMR connector.

AOpen Bonus Pack CD

A disc bundled with AOpen motherboard product, there are motherboard drivers, Acrobat Reader for [PDF](#) online manual and other useful utilities.



APM

Unlike [ACPI](#), BIOS controls most APM power management functions. AOpen Suspend to Hard Drive is a good example of APM power management.

ATA/66

ATA/66 uses both rising edge and falling edge but doubles [UDMA/33](#) transfer rate. The data transfer rate is 4 times of the PIO mode 4 or DMA mode 2, 16.6MB/s x4 = 66MB/s. To use ATA/66, you need special ATA/66 IDE cable.

ATA/100

ATA/100 is a new IDE specification under developing. ATA/100 uses both rising edge and falling edge as [ATA/66](#) but clock cycle time is reduced to 40ns. The data transfer rate is (1/40ns) x 2 bytes x 2 = 100MB/s. To use ATA/100, you need special 80-wire IDE cable, the same as ATA/66.

BIOS (Basic Input/Output System)

BIOS is a set of assembly routine/program that reside in [EPROM](#) or [Flash ROM](#). BIOS controls Input/output devices and other hardware devices of motherboard. In general, to provide hardware independent portability, operation system and drivers is required to access BIOS without directly access hardware devices.

Bus Master IDE (DMA mode)

The traditional PIO (Programmable I/O) IDE requires the CPU to involve in all the activities of the IDE access including waiting for the mechanical events. To reduce the workload of the CPU, the bus master IDE device transfers data from/to memory without interrupting CPU, and releases CPU to operate concurrently while data is transferring between memory and IDE device. You need the bus master IDE driver and the bus master IDE HDD to support bus master IDE mode.

CODEC (Coding and Decoding)

Normally, CODEC means a circuit that can do digital to analog conversion and also the analog to digital conversion. It is part of [AC97](#) sound/modem solution.

DIMM (Dual In Line Memory Module)

DIMM socket has total 168-pin and supports 64-bit data. It can be single or double side, the golden finger signals on each side of PCB are different, that is why it was called Dual In Line. Almost all DIMMs are made by [SDRAM](#), which operate at 3.3V. Note that some old DIMMs are made by FPM/[EDO](#) and only operate at 5V. Do not confuse them with SDRAM DIMM.

ECC (Error Checking and Correction)

The ECC mode needs 8 ECC bits for 64-bit data. Each time memory is accessed; ECC bits are updated and checked by a special algorithm. The ECC algorithm has the ability to detect double-bit error and automatically correct single-bit error while parity mode can only detect single-bit error.

EDO (Extended Data Output) Memory

The EDO DRAM technology is actually very similar to FPM (Fast Page Mode). Unlike traditional FPM that tri-states the memory output data to start the pre-charge activity, EDO DRAM holds the memory data valid until the next memory access cycle, that is similar to pipeline effect and reduces one clock state.

EEPROM (Electronic Erasable Programmable ROM)

Also known as E²PROM. Both EEPROM and [Flash ROM](#) can be re-programmed by electronic signals, but the interface technology is different. Size of EEPROM is much smaller than flash ROM.

EPROM (Erasable Programmable ROM)

Traditional motherboard stores BIOS code in EPROM. EPROM can only be erased by ultra-violet (UV) light. If BIOS has to be upgraded, you need to remove EPROM from motherboard, clear by UV light, re-program, and then insert back.

EV6 Bus

EV6 Bus in the technology of Alpha processor from Digital Equipment Corporation. EV6 bus uses both rising and falling clock edge to transfer data, similar as DDR SDRAM or ATA/66 IDE bus.

EV6 Bus Speed = CPU external bus clock x 2.

For example, 200 MHz EV6 bus is actually using 100 MHz external bus clock, but the equivalent speed is 200 MHz.

FCC DoC (Declaration of Conformity)

The DoC is component certification standard of FCC EMI regulations. This standard allows DIY component (such as motherboard) to apply DoC label separately without a shielding of housing.

FC-PGA

FC means Flip Chip, FC-PGA is a new package of Intel for Pentium III CPU. It can plug into SKT370 socket, but require motherboard to add some signals on socket 370. That is, the motherboard needs to be redesigned. Intel is going to ship FC-PGA 370 CPU and phase out slot1 CPU.

Flash ROM

Flash ROM can be re-programmed by electronic signals. It is easier for BIOS to upgrade by a flash utility, but it is also easier to be infected by virus. Because of increase of new functions, BIOS size is increased from 64KB to 256KB (2M bit). AOpen AX5T is the first board to implement 256KB (2Mbit) Flash ROM. Now flash ROM size is moving to 4M bit on AX6C (Intel 820) and MX3W (Intel 810) motherboard. , AOpen motherboard uses EEPROM for jumper-less and battery-less design.

FSB (Front Side Bus) Clock

FSB Clock means CPU external bus clock.

CPU internal clock = CPU FSB Clock x CPU Clock Ratio

I²C Bus

See [SMBus](#).

P1394

P1394 (IEEE 1394) is a standard of high-speed serial peripheral bus. Unlike low or medium speed [USB](#), P1394 supports 50 to 1000Mbit/s and can be used for video camera, disk and LAN.

Parity Bit

The parity mode uses 1 parity bit for each byte, normally it is even parity mode, that is, each time the memory data is updated, parity bit will be adjusted to have even count "1" for each byte. When next time, if memory is read with odd number of "1", the parity error is occurred and this is called single bit error detection.

PBSRAM (Pipelined Burst SRAM)

For Socket 7 CPU, one burst data read requires four QWord (Quad-word, $4 \times 16 = 64$ bits). PBSRAM only needs one address decoding time and automatically sends the remaining QWords to CPU according to a predefined sequence. Normally, it is 3-1-1-1, total 6 clocks, which is faster than asynchronous SRAM. PBSRAM is often used on L2 (level 2) cache of Socket 7 CPU. Slot 1 and Socket 370 CPU do not need PBSRAM.

PC100 DIMM

[SDRAM](#) DIMM that supports 100MHz CPU [FSB](#) bus clock.

PC133 DIMM

[SDRAM](#) DIMM that supports 133MHz CPU [FSB](#) bus clock.

PDF Format

A file format for electronic document, PDF format is independent from platform, you can read PDF file under Windows, Unix, Linux, Mac ... with different PDF reader. You can also read PDF file by web browser such as IE and Netscape, note that you need to install PDF plug-in first (Included in Acrobat Reader).

PnP (Plug and Play)

The PnP specification suggests a standard register interface for both BIOS and operating system (such as Windows 95). These registers are used by BIOS and operating system to configure system resource and prevent any conflicts. PnP BIOS or operating system will automatically allocate the IRQ/DMA/Memory. Currently, almost all the PCI cards and most ISA cards are already PnP compliant.

POST (Power-On Self Test)

The BIOS self-test procedure after power-on, sometimes, it is the first or the second screen shown on your monitor during system boot.

RDRAM (Rambus DRAM)

Rambus is a memory technology that uses large burst mode data transfer. Theoretically, the data transfer should be high than [SDRAM](#). RDRAM is cascaded in channel operation. For Intel 820, only one RDRAM channel is supported, 16-bit data per channel, and this channel may have maximum 32 RDRAM devices, no matter how many [RIMM](#) sockets.

RIMM

184-pin memory module that supports [RDRAM](#) memory technology. A RIMM memory module may contain up to maximum of 16 RDRAM devices.

SDRAM (Synchronous DRAM)

SDRAM is one of the DRAM technologies that allows DRAM to use the same clock as the CPU host bus ([EDO](#) and FPM are asynchronous and do not have clock signal). It is similar as [PBSRAM](#) to use burst mode transfer. SDRAM comes in 64-bit 168-pin [DIMM](#) and operates at 3.3V. AOpen is the first company to support dual-SDRAM DIMMs onboard (AP5V), from Q1 1996

Shadow E²PROM

A memory space in Flash-ROM to simulate E²PROM operation, AOpen motherboard uses Shadow E²PROM for jumper-less and battery-less design

SIMM (Single In Line Memory Module)

SIMM socket is only 72-pin, and is only single side. The golden finger signals on each side of PCB are identical. That is why it was called Single In Line. SIMM is made by FPM or [EDO](#) DRAM and supports 32-bit data. SIMM had been phased out on current motherboard design.

SMBus (System Management Bus)

SMBus is also called I2C bus. It is a two-wire bus developed for component communication (especially for semiconductor IC). For example, set clock of clock generator for jumper-less motherboard. The data transfer rate of SMBus is only 100Kbit/s, it allows one host to communicate with CPU and many masters and slaves to send/receive message.

SPD (Serial Presence Detect)

SPD is a small ROM or [EEPROM](#) device resided on the [DIMM](#) or [RIMM](#). SPD stores memory module information such as DRAM timing and chip parameters. SPD can be used by [BIOS](#) to decide best timing for this DIMM or RIMM.

Ultra DMA/33

Unlike traditional PIO/DMA mode, which only uses the rising edge of IDE command signal to transfer data. UDMA/33 uses both rising edge and falling edge, the data transfer rate is double of the PIO mode 4 or DMA mode 2.

16.6MB/s x2 = 33MB/s

USB (Universal Serial Bus)

USB is a 4-pin serial peripheral bus that is capable of cascading low/medium speed peripherals (less than 10Mbit/s) such as keyboard, mouse, joystick, scanner, printer and modem. With USB, the traditional complex cables from back panel of your PC can be eliminated.

VCM (Virtual Channel Memory)

NEC's Virtual Channel Memory (VCM) is a new DRAM core architecture that dramatically improves the memory system's ability to service multimedia requirements. VCM increases memory bus efficiency and performance of any DRAM technology by providing a set of fast static registers between the memory core and I/O pins. Using VCM technology results in reduced data access latency and reduced power consumption.

ZIP file

A compressed file format to reduce file size. To unzip file, run shareware PKUNZIP (<http://www.pkware.com/>) for DOS and other operating system or WINZIP (<http://www.winzip.com/>) for windows environment.



Troubleshooting

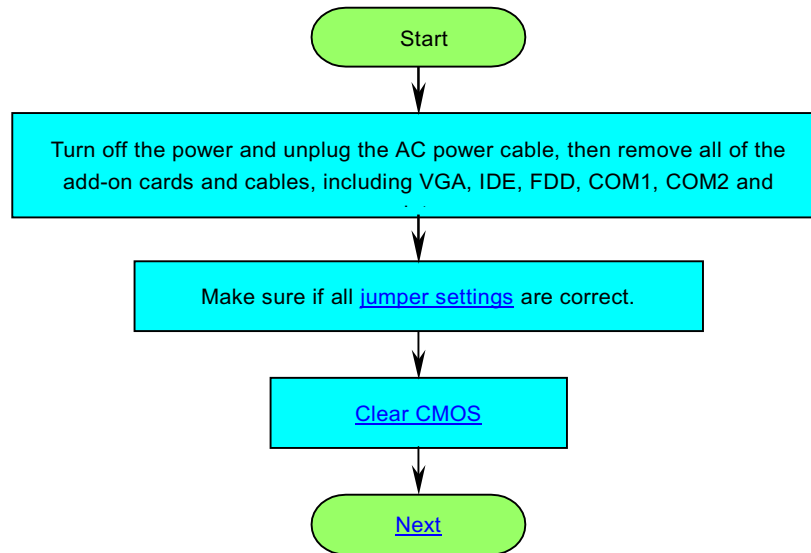

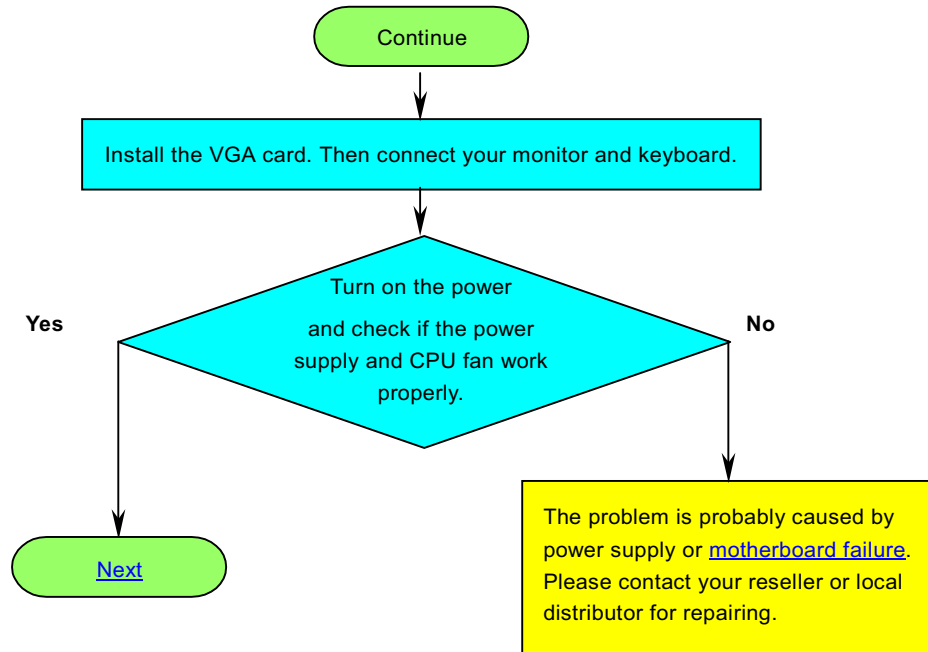

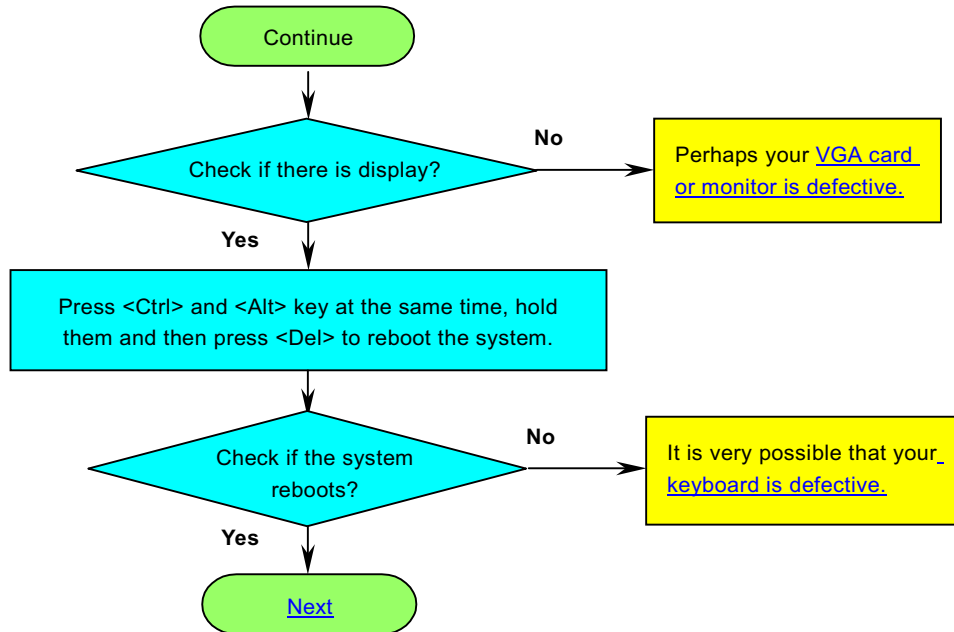

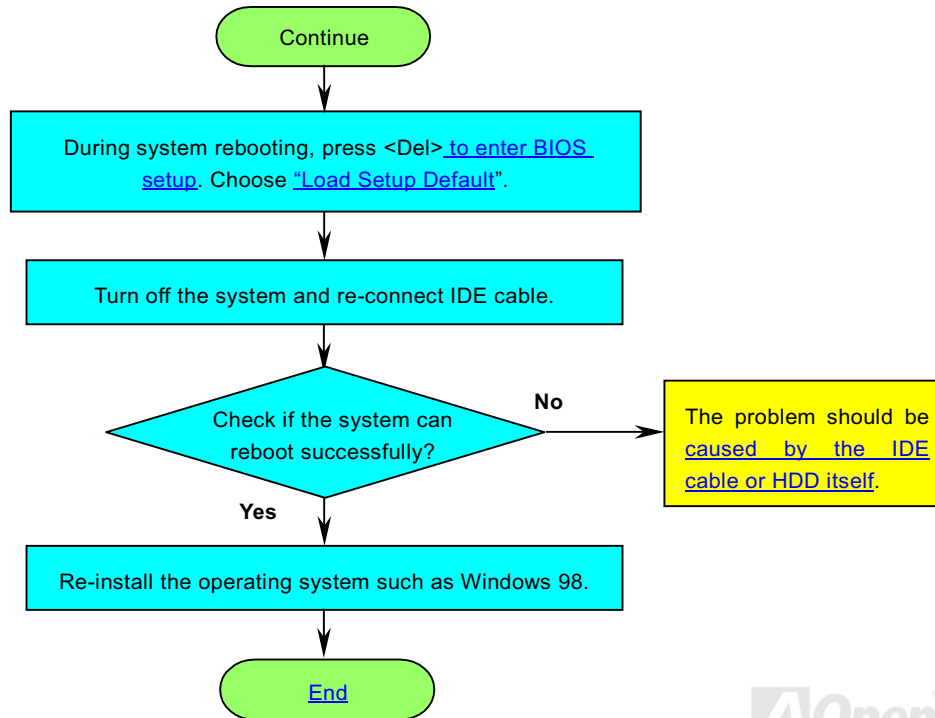



Technical Support

Dear Customer,

Thanks for choosing AOpen products. To provide the best and fastest service to our customer is our first priority. However, we receive numerous emails and phone-calls worldwide everyday, it is very hard for us to serve everyone on time. We recommend you follow the procedures below and seek help before contact us. With your help, we can then continue to provide the best quality service to more customers.

Thanks very much for your understanding!

AOpen Technical Supporting Team

1

Online Manual: Please check the manual carefully and make sure the jumper settings and installation procedure are correct.

<http://www.aopen.com.tw/tech/download/manual/default.htm>

2

Test Report: We recommend to choose board/card/device from the compatibility test reports for assembling your PC.

<http://www.aopen.com.tw/tech/report/default.htm>

3

FAQ: The latest FAQ (Frequently Asked Questions) may contain a solution to your problem.

<http://www.aopen.com.tw/tech/faq/default.htm>

4

Download Software: Check out this table to get the latest updated BIOS/utility and drivers.

<http://www.aopen.com.tw/tech/download/default.htm>

5

News Group: Your problem probably had been answered by our support engineer or professional users on the news group.

<http://www.aopen.com.tw/tech/newsgrp/default.htm>

6

Contact Distributors/Resellers: We sell our products through resellers and integrators. They should know your system configuration very well and should be able to solve your problem more efficiently than us. After all, their attitude of service is an important reference for you if next time you want to buy something else from them.

7

Contact Us: Please prepare detail system configuration and error symptom before contacting us. The **part number**, **serial number** and **BIOS version** are also very helpful.

Part Number and Serial Number

The Part Number and Serial number are printed on bar code label. You can find this bar code label on the outside packing, on ISA/CPU slot or on component side of PCB. For example:



Part No.



Serial No.

P/N: 91.88110.201 is part number, **S/N: 91949378KN73** is serial number.

Model name and BIOS version

Model name and BIOS version can be found on upper left corner of first boot screen ([POST](#) screen). For example:

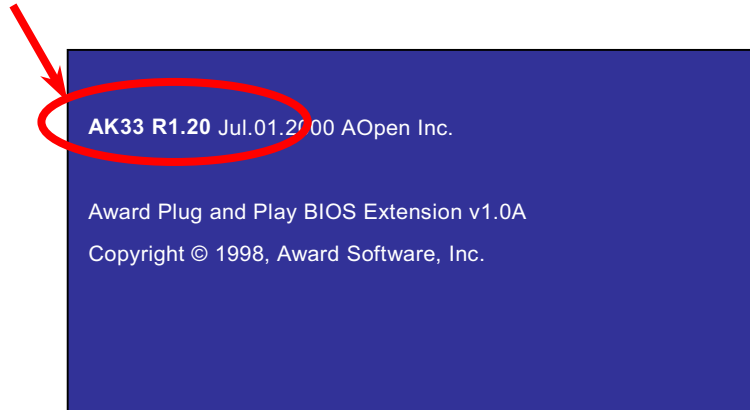

AK33 is model name of motherboard, **R1.20** is BIOS version.



Product Registration

Club AOpen Welcome to AOpen Inc.

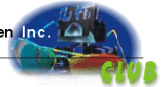

Thank you for choosing AOpen product. AOpen encourages you to spend few minutes in completing the following product registration. To register your product will ensure the high quality of services from AOpen. After the registration, you will:

- Have opportunities to play online slot machine and win a prize from AOpen by accumulating your bonuses for later prize exchange.
- Be upgraded to gold membership of Club AOpen program.
- Receive email notification about product safety alerts. Its purpose is to alert consumers quickly and conveniently when products contain technical issues.
- Receive email notification about latest product's announcements.
- Be able to personalize your AOpen web pages.
- Receive e-mail notification about latest BIOS/Driver/Software release information.
- Have opportunities to participate special product promotional programs.
- Enjoy higher service priority to receive technical assistance provided by Aopen specialists worldwide.



- Be able to join the discussions of web-based news groups.

AOpen makes sure that the information you provide is encrypted, so that it cannot be read or intercepted by other people or companies. Further, AOpen will not disclose any of information you submitted under any conditions. Please consult our [online privacy policy](#) for further information on our company policy.

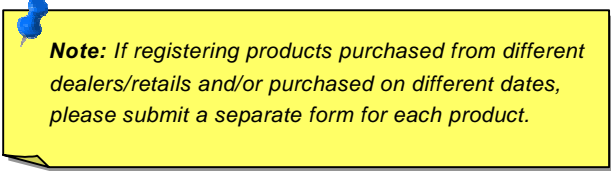

Note: *If registering products purchased from different dealers/retails and/or purchased on different dates, please submit a separate form for each product.*

Web: <http://www.aopen.com>

Email : Send us email by going through the contact form below.

English <http://www.aopen.com.tw/tech/contact/techusa.htm>

Japanese <http://aojp.aopen.com.tw/tech/contact/techjp.htm>

Chinese <http://w3.aopen.com.tw/tech/contact/techtw.htm>

German <http://www.aopencom.de/tech/contact/techde.htm>

Simplified Chinese <http://www.aopen.com.cn/tech/contact/techcn.htm>

TEL:

USA	650-827-9688
Netherlands	+31 73-645-9516
China	(86) 755-375-3013
Taiwan	(886) 2-2696-1333
Germany	+49 (0) 2102-157-700