

# Fortress 7700 User's Guide

DOC. NO. : DX37PU-OL-E0110A



Copyright © 2001 AOpen Incorporated

All Rights Reserved.

AOpen Fortress 7700

User's Guide

Changes may be made periodically to the information in this publication without obligation to notify any person of such revision or changes. Such changes will be incorporated in new editions of this manual or supplementary documents and publications. This company makes no representations or warranties either expressed or implied, with respect to the contents hereof and specifically disclaims the implied warranties of merchantability or fitness for a particular purpose.

No part of this publication may be reproduced, stored in a retrieval system, or transmitted, in any form or by any means, electronic, mechanical, photocopy, recording, or otherwise, without the prior written permission of Aopen Incorporated.

All brand and product names mentioned in this manual are trademarks and/or registered trademarks of their respective companies.



## ***Important Safety Instructions***

1. Read these instructions carefully. Save these instructions for future reference.
2. Follow all warnings and instructions marked on the product.
3. Do not use this product near water.
4. Do not place this product on an unstable cart, stand, or table. The product may fall, causing serious damage to the product.
5. Slots and openings in the cabinet and the back or bottom are provided for ventilation; to ensure reliable operation of the product and to protect it from overheating, these openings must not be blocked or covered. The openings should never block by placing the product on a bed, sofa, rug, or other similar surface. This product should never be placed near or over a radiator or heat register, or in a built-in installation unless proper ventilation is provided.
6. This product should be operated from the type of power indicated on the marking label. If you are not sure of the type of power available, consult your dealer or local power company.
7. This product is equipped with a 3-wire grounding-type plug, a plug having a third (grounding) pin. This plug will only fit into a grounding-type power outlet. This is a safety feature. If you are unable to insert the plug into the outlet, contact your electrician to replace your obsolete outlet. Do not defeat the purpose of the grounding-type plug.
8. Do not allow anything to rest on the power cord. Do not locate this product where persons will

walk on the cord.

9. If an extension cord is used with this product, make sure that the total ampere rating of the equipment plugged into the extension cord does not exceed the extension cord ampere rating. Also, make sure that the total rating of all products plugged into the wall outlet does not exceed 15 amperes.
10. Never push objects of any kind into this product through cabinet slots as they may touch dangerous voltage points or short out parts that could result in a fire or electric shock. Never spill liquid of any kind on the product.
11. Do not attempt to service this product yourself, as opening or removing covers may expose you to dangerous voltage points or other risks. Refer all servicing to qualified service personnel.
12. Unplug this product from the wall outlet and refer servicing to qualified service personnel under the following conditions:
  - a. When the power cord or plug is damaged or frayed
  - b. If liquid has been spilled into the product
  - c. If the product has been exposed to rain or water
  - d. If the product does not operate normally when the operating instructions are followed. Adjust only those controls that are covered by the operating instructions since improper adjustment of other controls may result in damage and will often require

extensive work by a qualified technician to restore the product to normal condition.

- e. If the product has been dropped or the cabinet has been damaged
  - f. If the product exhibits a distinct change in performance, indicating a need for service
13. Replace the battery with the same type as the product's battery we recommend. Use of another battery may present a risk of fire or explosion. Refer battery replacement to a qualified serviceman.
14. Warning! The battery could explode if not handled properly. Do not recharge, disassemble or dispose of it in fire. Keep it away from children and dispose of my used battery promptly.

***Use only the proper type of power supply cord set (provided in your keyboard/manual accessories box) for this unit. It should be a detachable type: UL listed/CSA certified, type SVT/SJT, rated 6A 125V minimum, VDE approved or its equivalent. Maximum length is 15 feet (4.6 meters).***

## **CD-ROM Safety Warning**

**DANGER**

**INVISIBLE RADIATION WHEN OPEN.**

**AVOID EXPOSURE TO BEAM.**

CLASS 1 LASER PRODUCT  
APPAREIL A LASER DE CLASSE 1  
LASER KLASSE 1  
LOUKAN 1 LASERLAITE  
PRODUIT LASER  
CATEGORIE 1

## **Caution on Lithium Batteries**

### **CAUTION:**

Danger of explosion if battery is incorrectly replaced. Replace only with the same or equivalent type recommended by the manufacturer. Discard used batteries according to the manufacturer's instructions.

## **FCC Class B Radio Frequency Interference Statement**

### **Note:**

This equipment has been tested and found to comply with the limits for a Class B digital device, pursuant to Part 15 of FCC Rules. These limits are designed to provide reasonable protection against harmful interference in a residential installation. This equipment generates, uses, and can radiate radio frequency energy and, if not installed and used in accordance with the instructions, may cause harmful interference to radio communications. However, there is no guarantee that interference will not occur in a particular installation. If this equipment does cause harmful interference to radio or television reception, which can be determined by turning the equipment off and on, the user is encouraged to try to correct the interference by one or more of the following measures:

1. Reorient or relocate the receiving antenna.

2. Increase the separation between the equipment and receiver.
3. Connect the equipment into an outlet on a circuit different from that to which the receiver is connected.
4. Consult the dealer or an experienced radio/television technician for help.

**Notice 1:**

The changes or modifications not expressly approved by the party responsible for compliance could void the user's authority to operate the equipment.

**Notice 2:**

Shielded interface cables, if any, must be used in order to comply with the emission limits.



## About this Manual

### Purpose

This user's guide aims to give you the information you need to operate the system properly and tells you how to install internal components.

### Manual Structure

This user's guide consists of four chapters.

#### **Chapter 1 Fortress 7700 Housing (SV320)**

This chapter describes the housing and all its major components. It contains instructions for upgrade options and installation procedures.

#### **Chapter 2 Fortress 7700 Motherboard (DX37Plus-U)**

This chapter describes the motherboard and all its major components. It contains the motherboard layout, jumper settings, cache and memory configurations, and information on other internal devices.

#### **Chapter 3 BIOS Setup Utility**

This chapter gives information about the system BIOS and tells how to configure the system by changing the settings of the BIOS parameters.

#### **Chapter 4 SCSI Select Configuration Utility**

This chapter gives information about the SCSI Select utility and tells how to configure the SCSI configuration by changed the settings of the SCSI parameters.

## Conventions

The following conventions are used in this manual:

Text entered by user

  , etc....



Represents text input by the user.

Represent the actual keys that you have to press on the keyboard.

### NOTE

Gives bits and pieces of additional information related to the current topic.

### CAUTION

Gives precautionary measures to avoid possible hardware or software problems.

### IMPORTANT

Reminds you to take specific actions relevant to the accomplishment of procedures.

## What's in this manual

<b>Fortress 7700 .....</b>	<b>1</b>
IMPORTANT SAFETY INSTRUCTIONS .....	3
CD-ROM SAFETY WARNING .....	6
CAUTION ON LITHIUM BATTERIES .....	7
FCC CLASS B RADIO FREQUENCY INTERFERENCE STATEMENT .....	7
ABOUT THIS MANUAL .....	9
CONVENTIONS .....	10
WHAT'S IN THIS MANUAL .....	11
<b>CHAPTER 1 HOUSING INSTRUCTION (SV320) .....</b>	<b>24</b>
1.1 INTRODUCTION .....	24
1.2 STANDALONE SYSTEM .....	25
1.3 FEATURES .....	26
1.3.1 Front Panel .....	26
1.3.2 Rear Panel .....	27
1.3.3 Internal Structure .....	28

1.4 OPENING THE HOUSING PANELS .....	29
1.4.1 Front Panel .....	29
1.4.2 Left Panel .....	30
1.5 INSTALLING DEVICE DRIVES .....	31
1.5.1 3.5-inch Device Drive .....	31
1.5.2 5.25-inch Device Drives .....	33
1.6 INSTALLING HOT-SWAP CAGES .....	35
1.6.1 Installing a HSC5 Hot-Swap Cage .....	35
1.6.2 Installing and Removing a HSC5 Hard Disk Drive Tray .....	38
1.6.3 HSC5 LVD SCSI Backplane Board .....	39
1.6.4 HSC5 Jumpers and Connectors .....	40
1.7 INSTALLING AND REMOVING A HOT-SWAPPABLE REDUNDANT POWER SUPPLY MODULE .....	43
1.8 INSTALLING AN EXTERNAL REDUNDANT SYSTEM FAN (OPTIONAL) .....	46
1.9 INSTALLING A MOTHERBOARD .....	48
1.10 INSTALLING AN EXPANSION CARD .....	49
<b>CHAPTER 2 HARDWARE INSTALLATION .....</b>	<b>50</b>

2.1 OVERVIEW .....	50
2.2 FEATURE HIGHLIGHT .....	51
<i>CPU</i> .....	51
<i>Chipset</i> .....	51
<i>Memory</i> .....	51
<i>Expansion Slots</i> .....	52
<i>SCSI On-board</i> .....	52
<i>Ultra DMA 33/66/100 Bus Master IDE</i> .....	53
<i>Intel 82550 LAN controller</i> .....	53
<i>Power Management/Plug and Play</i> .....	54
<i>Hardware Monitoring Management</i> .....	54
<i>Super Multi-I/O</i> .....	54
2.3 MOTHERBOARD MAP .....	55
2.4 BLOCK DIAGRAM .....	56
2.5 CONNECTORS AND JUMPERS .....	57
2.6 HARDWARE .....	60

2.6.2 CPU Installation .....	62
2.6.3 CPU & Housing Fan Connector .....	63
2.6.4 Supported CPU Type .....	64
2.6.5 Setting CPU Voltage and Frequency .....	65
2.6.6 DIMM Socket .....	67
2.6.7 ATX Power Connector and AGP Pro Power Connector.....	68
2.6.8 Redundant SPS Monitoring Connector .....	69
2.6.9 IDE and Floppy Connector .....	70
2.6.10 68-pin Ultra 160 SCSI Connector .....	73
2.6.11 Front Panel Connector .....	74
2.6.12 WOL (Wake on LAN).....	75
2.6.13 Support 4 USB Connectors.....	77
2.6.14 SCSI LED Connector (For SCSI/RAID Card Only).....	78
2.6.15 CD/AUX Connector .....	79
2.6.16 PC99 Color Coded Back Panel.....	80
2.6.17 Support 10/100 Mbps LAN onboard.....	81

2.6.18 Low ESR Capacitor.....	82
<b>CHAPTER 3 BIOS SETUP UTILITY .....</b>	<b>83</b>
3.1 ENTERING SETUP.....	84
3.2 SYSTEM INFORMATION .....	86
3.2.1 Processor .....	87
3.2.2 Processor Speed.....	87
3.2.3 CPU/SDRAM BUS Frequency.....	87
3.2.4 Level 1 Cache.....	87
3.2.5 Level 2 Cache.....	88
3.2.6 Diskette Drive A.....	88
3.2.7 Diskette Drive B.....	88
3.2.8 IDE Primary Channel Master .....	88
3.2.9 IDE Primary Channel Slave.....	89
3.2.10 IDE Secondary Channel Master.....	89
3.2.11 IDE Secondary Channel Slave.....	89
3.2.12 Total Memory .....	89

3.2.13 Serial Port 1 .....	90
3.2.14 Serial Port 2 .....	90
3.2.15 Parallel Port .....	90
3.2.16 PS/2 Mouse .....	90
3.3 PRODUCT INFORMATION .....	91
3.3.1 Product Name .....	92
3.3.2 System S/N .....	92
3.3.3 Main Board ID .....	92
3.3.4 Main Board S/N .....	92
3.3.5 System BIOS Version .....	92
3.3.6 SMBIOS Version .....	93
3.4 DISK DRIVES .....	94
3.4.1 Floppy Drives .....	95
3.4.2 IDE Drives .....	95
3.5 ONBOARD PERIPHERALS .....	99
3.5.1 Serial Ports 1 and 2 .....	100



3.5.2 Parallel Port .....	101
3.5.3 Onboard Device Settings.....	104
3.6 POWER MANAGEMENT .....	108
3.6.1 Power Management Mode.....	109
3.6.2 Power Switch < 4 sec.....	111
3.6.3 System Wake-up Event.....	111
3.7 BOOT OPTIONS .....	114
3.7.1 Boot Sequence.....	115
3.7.2 Fast Boot.....	115
3.7.3 Silent Boot.....	116
3.7.4 Num Lock After Boot.....	116
3.7.5 Memory Test.....	117
3.7.6 Release All Blocked Memory.....	117
3.8 DATE AND TIME .....	118
3.8.1 Date .....	119
3.8.2 Time.....	119

3.9 SYSTEM SECURITY .....	120
3.9.1 Supervisor Password.....	121
3.9.2 User Password.....	122
3.9.3 Disk Drive Control.....	123
3.9.4 Processor Serial Number .....	124
3.10 SYSTEM EVENT LOG.....	125
3.10.1 System Event Logging .....	126
3.10.2 Events Control.....	127
3.10.3 Event Process.....	129
3.11 LOAD DEFAULT SETTINGS .....	130
3.12 ABORT SETTINGS CHANGE .....	131
<b>CHAPTER 4 SCSISELECT™ UTILITY.....</b>	<b>132</b>
<i>Settings for the SCSI Controller and All Devices .....</i>	<i>132</i>
<i>Individual Settings for SCSI Drives.....</i>	<i>133</i>
<i>When to Use the SCSISelect™ Utility.....</i>	<i>134</i>
4.1 RUNNING THE SCSISELECT™ UTILITY .....	135

4.2 UTILITY OPTIONS .....	136
4.2.1 <i>Configuring Channel A</i> .....	137
4.3 CONFIGURE/VIEW HOST ADAPTER SETTINGS MENU .....	139
4.3.1 <i>Host Adapter SCSI ID</i> .....	140
4.3.2 <i>SCSI Parity Checking</i> .....	142
4.3.3 <i>Boot Device Options</i> .....	144
4.3.4 <i>Boot Channel Options</i> .....	145
4.3.5 <i>Boot SCSI ID Options</i> .....	146
4.3.6 <i>Boot LUN Number Options</i> .....	147
4.3.7 <i>Boot LUN Number</i> .....	148
4.4 ADVANCED CONFIGURATION OPTIONS .....	153
4.4.1 <i>Host Adapter BIOS</i> .....	154
4.4.2 <i>Display &lt;Ctrl-A&gt; Message During BIOS Initialization</i> .....	154
4.4.3 <i>Extended BIOS Translation for DOS Drives &gt; 1 GByte</i> .....	154
4.4.4 <i>Support Removable Disks Under BIOS as Fixed Disks</i> .....	155
4.4.5 <i>BIOS Support for Bootable CD-ROM</i> .....	156

4.4.6 BIOS Support for Int13 Extensions .....	157
4.5 SCSI DISK UTILITIES .....	158
4.5.1 Format Disk .....	160
4.5.2 Verify Media .....	161
4.6 DISK DRIVES OVER 1 GBYTE.....	162
4.6.1 Extended Translation.....	162
4.6.2 DOS 1 GByte Limit.....	162
4.7 WHEN TO USE THE EXTENDED TRANSLATION .....	164
4.7.1 with DOS 5.0 and above.....	164
4.7.2 drives with mixed partitions .....	164
4.7.3 Using FDISK.....	164
<b>GLOSSARY .....</b>	<b>165</b>
AC97 .....	165
ACPI (ADVANCED CONFIGURATION & POWER INTERFACE) .....	165
AGP (ACCELERATED GRAPHIC PORT).....	166
AMR (AUDIO/MODEM RISER) .....	166

AOPEN BONUS PACK CD .....	166
APM .....	167
ATA/66.....	167
ATA/100.....	167
BIOS (BASIC INPUT/OUTPUT SYSTEM) .....	168
BUS MASTER IDE (DMA MODE).....	168
CODEC (CODING AND DECODING).....	168
DIMM (DUAL IN LINE MEMORY MODULE) .....	169
ECC (ERROR CHECKING AND CORRECTION).....	169
EDO (EXTENDED DATA OUTPUT) MEMORY.....	169
EEPROM (ELECTRONIC ERASABLE PROGRAMMABLE ROM) .....	170
EPROM (ERASABLE PROGRAMMABLE ROM).....	170
EV6 BUS.....	170
FCC DoC (DECLARATION OF CONFORMITY).....	171
FC-PGA.....	171
FLASH ROM.....	171

FSB (FRONT SIDE BUS) CLOCK .....	172
I <sup>2</sup> C BUS .....	172
P1394.....	172
PARITY BIT .....	172
PBSRAM (PIPELINED BURST SRAM) .....	173
PC100 DIMM .....	173
PC133 DIMM .....	173
PDF FORMAT .....	174
PNP (PLUG AND PLAY) .....	174
POST (POWER-ON SELF TEST) .....	174
RDRAM (RAMBUS DRAM) .....	175
RIMM.....	175
SDRAM (SYNCHRONOUS DRAM) .....	175
SIMM (SINGLE IN LINE MEMORY MODULE).....	176
SMBUS (SYSTEM MANAGEMENT BUS) .....	176
SPD (SERIAL PRESENCE DETECT).....	176

ULTRA DMA/33 .....	177
USB (UNIVERSAL SERIAL BUS) .....	177
VCM (VIRTUAL CHANNEL MEMORY) .....	177
ZIP FILE .....	178
<b>TROUBLESHOOTING .....</b>	<b>179</b>
<b>TECHNICAL SUPPORT .....</b>	<b>183</b>
<b>PART NUMBER AND SERIAL NUMBER .....</b>	<b>185</b>
<b>PRODUCT REGISTRATION .....</b>	<b>186</b>
<b>HOW TO CONTACT US .....</b>	<b>187</b>

# Chapter 1 Housing Instruction (SV320)

## 1.1 Introduction

This installation guide describes the features of the SV320 housing and tells you how to install the basic system components such as disk drives, a motherboard, or expansion boards.



*If you receive a complete system, the basic components are already installed.*



## 1.2 Standalone System

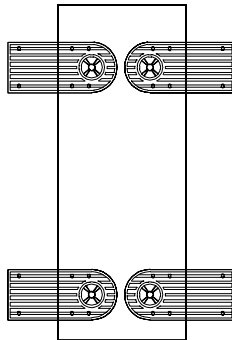

The SV320 housing is designed both as standalone and rackmount system housing. Rotate the feet outward to stabilize it when placed as standalone housing.

## 1.3 Features

### 1.3.1 Front Panel

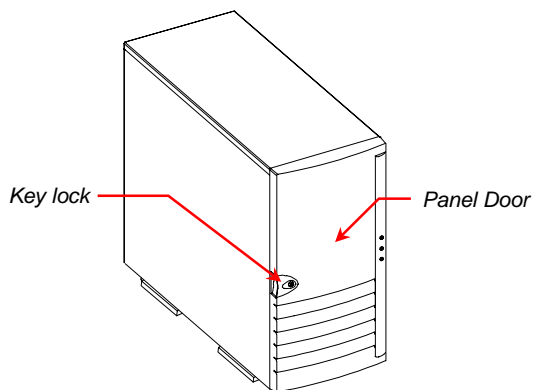

1.3.2 Rear Panel

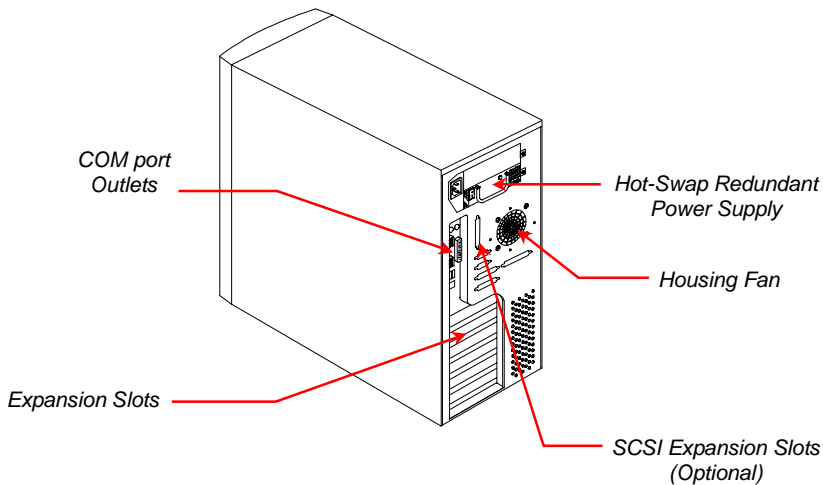

### 1.3.3 Internal Structure

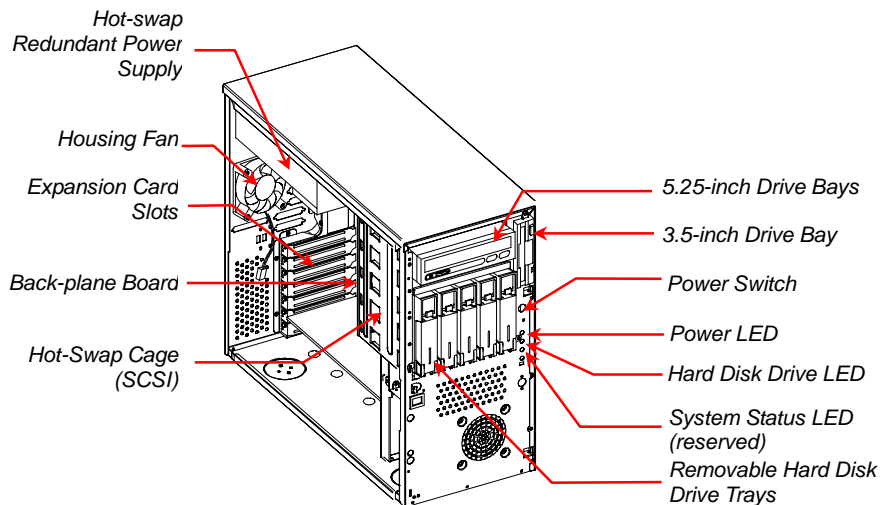

## **1.4 Opening the Housing Panels**

### **1.4.1 Front Panel**

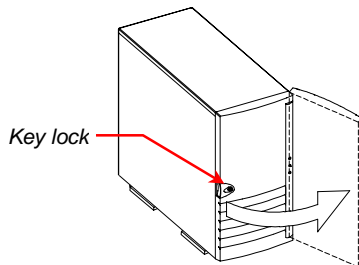

To open the front panel, use the key to unlock and then pull the panel as shown in the illustration above.

## 1.4.2 Left Panel

To remove the left panel:

1. Use a screwdriver to remove the two front screws. Keep them in a safe place for later use.
2. Pull the panel handle out and use it to remove the left panel from the housing.

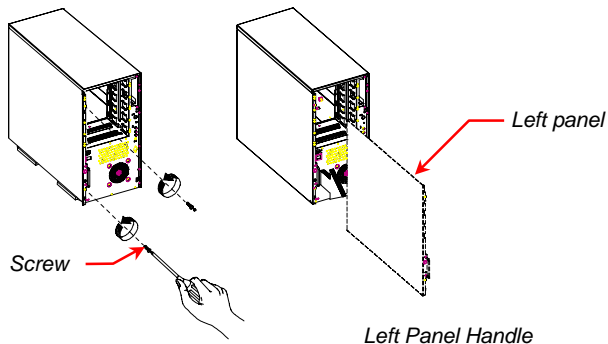

## 1.5 Installing Device Drives



*Turn off the power switch and unplug the power cord before installing or removing diskette drives.*

### 1.5.1 3.5-inch Device Drive

To install 3.5-inch device drives:

1. Open the front panel of the housing. See section 1.4.1 for more information on opening the housing panel.
2. Detached the 3.5-inch drive frame (2 pieces) from the housing by removing two screws. Keep the screws for later use.
3. Attached the drive frames to the 3.5-inch drive securing it with four screws as shown below.

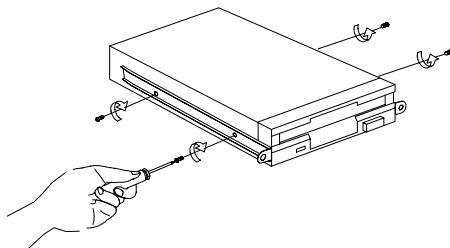

4. Insert the drive into the drive bay and secure it with two screws.

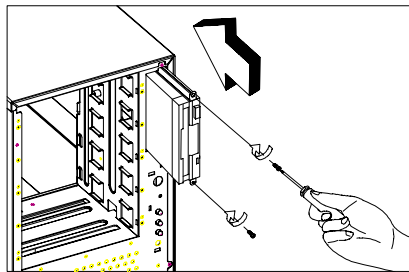

5. Connect the diskette drive cables and close the housing panels.



### 1.5.2 5.25-inch Device Drives

You may install a CD-ROM, digital-audio tape (DAT), hard disk, diskette drive or any other 5.25-inch device into the drive bay.

To install 5.25-inch devices:

1. Open the front panel. See section 1.4.1 for more information on opening the housing panel.
2. Detached the 5.25-inch drive frame (2 pieces) from the housing by removing two screws. Keep the screws for later use.
3. Attached the drive frames to the 5.25-inch device drive securing it with four screws as shown below.

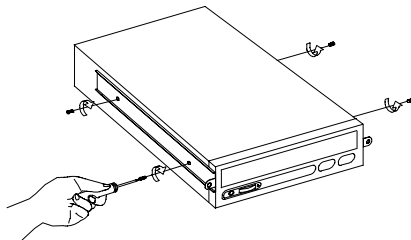

4. Insert the drive into the drive bay and secure it with two screws.

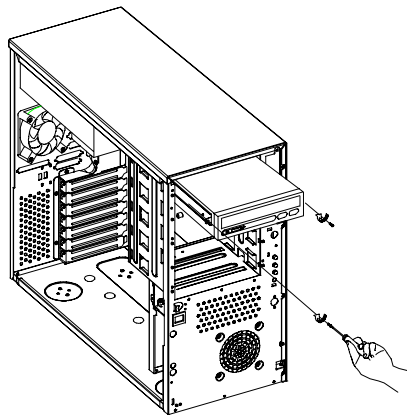

5. Connect the signal and power cables to the drive and close the housing panels.

## **1.6 Installing Hot-Swap Cages**

The SV320 system housing comes with one HSC5 hot-swap cage. The HSC5 hot-swap cage box includes the following components:

- One hot-swap cage (with back plane board attached)
- Five hard disk drive tray
- One SCSI terminator

### **1.6.1 Installing a HSC5 Hot-Swap Cage**

To install the hot-swap cage into the housing:

1. Open the front panel and remove the left panel of the housing. See section 1.4.1 for more information on opening the housing panels.
2. Insert the hot-swap cage into the housing and secure the hot-swap cage with two screws as shown below.

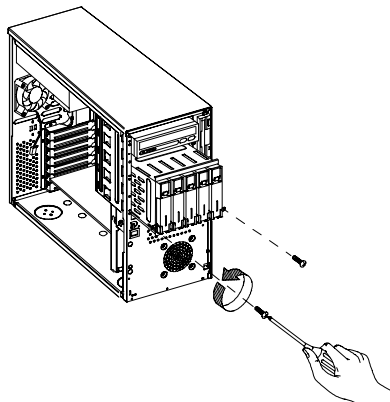

*We suggest you use the lower three 5.25" bays.*

3. Locate the LVD SCSI cable and remove the terminator located at the end of the LVD SCSI cable.

4. Attach the power cable and the LVD SCSI cable to the backplane board. The LVD SCSI cable can be connected to either onboard SCSI channel A or B (channel B recommended), or RAID card to form a RAID configuration.

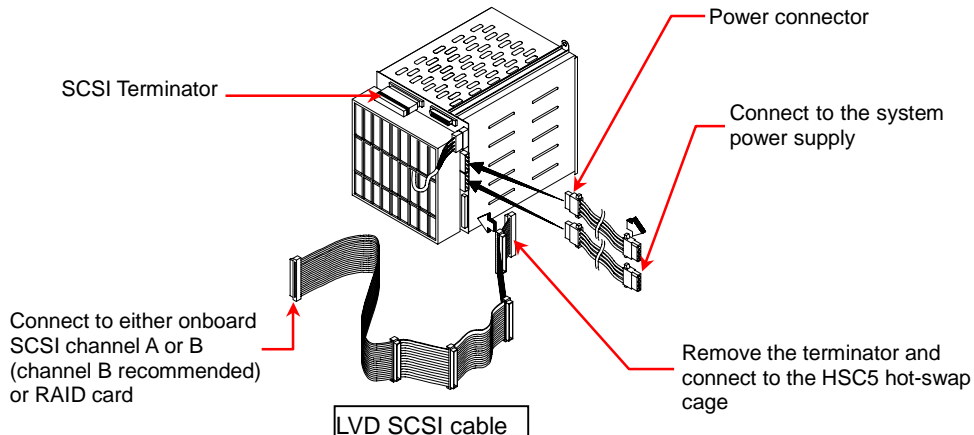

### 1.6.2 Installing and Removing a HSC5 Hard Disk Drive Tray

To remove and install a HSC5 Hard Disk Drive Tray:

1. Use your finger to release the drive tray and then pull it out.

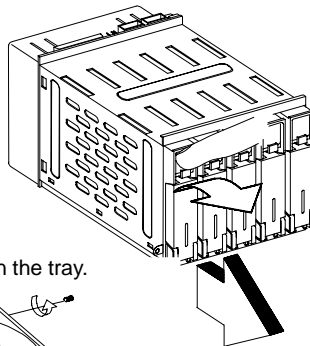

2. Remove all jumpers on the hard disk and place it on the tray. Secure it with four screws.

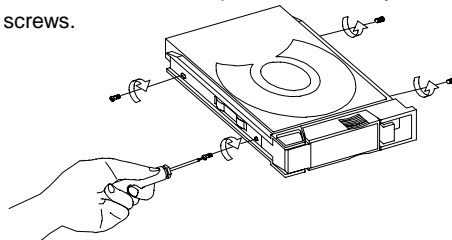

3. Insert the tray into the hot-swap cage with the lever still extended. Make sure that the drive is properly inserted before closing the lever.

### 1.6.3 HSC5 LVD SCSI Backplane Board

The HSC5 LVD SCSI hot-swap cage supports five 1-inch SCA SCSI hard drives in one channel. The SCA connector design allows for the addition and removal of SCSI drives without shutting down the system.

## ***Backplane Features***

The backplane board has the following major features:

- “Hot-swap” feature that allows replacement of hard drives even when the system is still on.
- Indicates hard disk drive failure through a front panel board LED on cage.
- Supports ultra-2 SCSI SCA (Single Connector Attachment) disk drives.

SCSI ID strapping that allows SCSI HDD ID configuration through the backplane switches, instead of configuring the individual drive IDs.

### 1.6.4 HSC5 Jumpers and Connectors

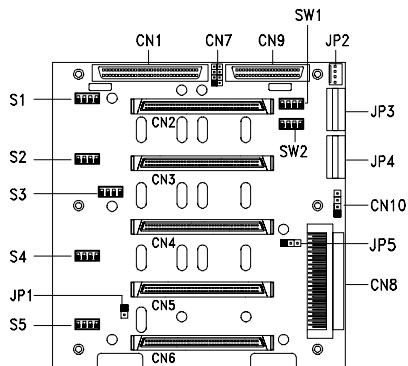

Jumper	Setting	Function
JP1	Short/Open	<b>Terminator Power Source</b> Both from Backplane and Host Only from Host
SW1 & SW2		<b>Reserved</b>



Connector	Description
CN1	SCSI 68-pin connector - Out
CN2	Slot 1
CN3	Slot 2
CN4	Slot 3
CN5	Slot 4
CN6	Slot 5
CN7	Front panel LED connector (reserved)
CN8	SCSI 68-pin connector - In
CN9	Reserved
CN10	HDD fault LED connector (reserved)
JP2	FAN connector
JP3 <sup>1</sup>	Power connector
JP4	Power connector
JP5	Reserved
S1 <sup>2</sup>	Slot 1 ID switch

Connector	Description
S2	Slot 2 ID switch
S3	Slot 3 ID switch
S4	Slot 4 ID switch
S5	Slot 5 ID switch

- 1 For HSC5 power loading requirement, please use independent power connectors to connect HSC5. If there is more than one connector on the same wire, those additional connectors should not be used.
- 
- 2 Please remove all jumpers on each SCSI hard drive before installing. Use the switches on the backplane board (S1~S5) to configure the hard drive? ID.

## **1.7 Installing and Removing a Hot-swappable Redundant Power Supply Module**

The power subsystem consists of two hot-swappable power supply module bays that allow the installation of two 337-watts power supply modules in a hot-swappable redundant configuration. A redundant power configuration enables a fully-configure system to continue running even if one power supply fails.



*The SV320 comes with one hot-swappable redundant power supply installed.*

To install a hot-swappable redundant power supply, please follow the steps as shown below.

1. Insert the power supply into the housing.

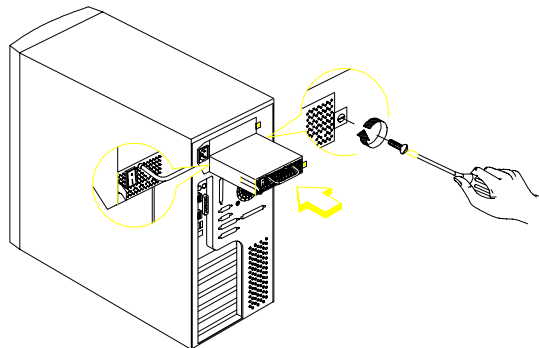

*Make sure that the power supply is properly inserted.*

2. Secure the power supply with a screw.

To remove a hot-swappable redundant power supply, please follow the steps as shown below.

1. Using a flat-head screwdriver, turn the screw counter clockwise to loosen the power supply.
2. Push the metal lock towards the power supply as shown below and gently pull out the power supply using the metal handle.

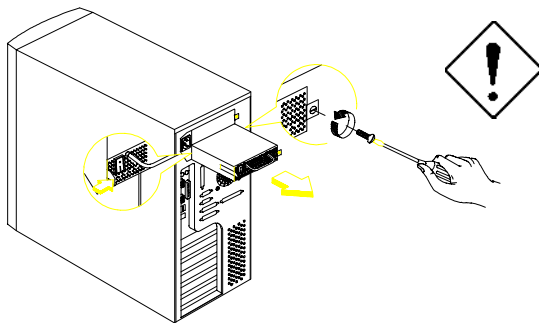

*The power supply subsystem should supply a minimum of 337-Watts to the whole system. If you only have one power supply or if you have two power supplies and are planning to remove both of them, remember to turn off the power first and disconnect the power cord from the electrical outlet.*

## **1.8 Installing an External Redundant System Fan (Optional)**

An additional external redundant fan can be installed behind the system housing. This allows the system to operate properly even though the internal housing fan failed.

To install an external redundant fan:

1. Open the front panel and remove the left panel of the housing. See section 1.4.1 for more information on opening the housing panels.
2. Use the screwdriver to push open the plastic peg located below the internal system fan module.
3. Insert the redundant fan into the fan cage and attach the fan cage to the system housing with four screws as shown below.

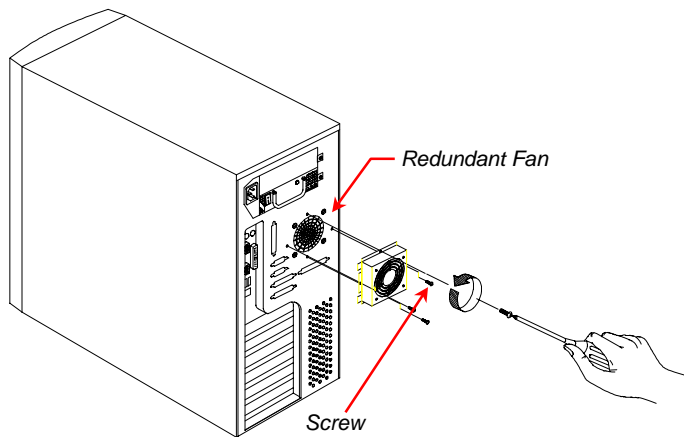

4. Insert the fan cable into the peg hole and attach the cable to the motherboard. The fan can be connected to the motherboard fan connector.

## 1.9 Installing a Motherboard

The housing accommodates various motherboard sizes. You can rearrange the stand-offs on the motherboard plate to fit the board that you wish to install.

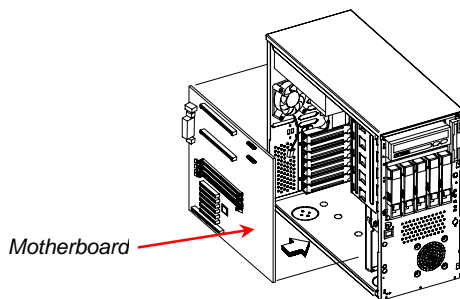

Align the motherboard holes to the pegs with the external ports facing the rear of the housing. Secure the board with eight screws.



## 1.10 Installing an Expansion card

To install an expansion card:

1. Remove an expansion slot bracket cover. Save the screw to secure the expansion card.

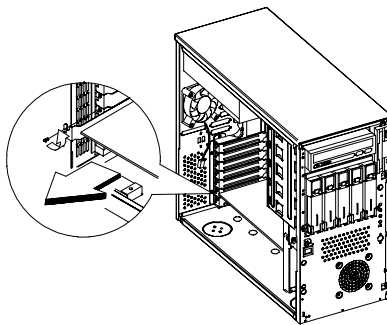

2. Align an expansion board with the open slot and insert the golden fingers into the expansion bus connector.
3. Secure the board with the screw.

## Chapter 2 Hardware Installation

### 2.1 Overview

Thank you for choosing AOpen DX37Plus-U. The DX37Plus-U is Intel® Socket 370 motherboard (M/B) based on the ATX form factor featuring the VIA Apollo Pro266T chipset. As high performance chipset built in the M/B, the DX37Plus-U can support Intel® Socket 370 series Pentium III™ (Both Coppermine & Tualatin are supported) and 100/133 CPU [Front Side Bus](#) (FSB). In the [AGP](#) performance, it supports AGP 1X/2X/4X/PRO mode and pipelined spilt-transaction long burst transfer up to 1056MB/sec. The maximum SDRAM memory size can be up to 2 GB. The DX37Plus-U also has on-board Adaptec 7899W dual channel Ultra 160 SCSI controller that provides the highest data transformation between interfaces up to 160MB/s. Now, enjoy all features from AOpen DX37Plus-U.

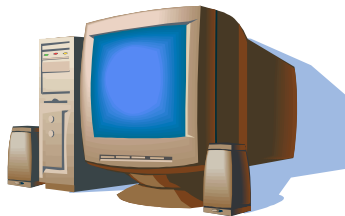

## 2.2 Feature Highlight

### CPU

Supports single/dual Intel® FC-PGA Pentium III (Both Coppermine & Tualatin are supported) 600MHz~1.26GHz with 100/133MHz FSB (Front Side Bus) designed for Socket 370 technology.

### Chipset

Uses the high performance the VIA® Apollo 266T chipset in DX37Plus-U. This chipset contains the various controller inclusive 32-bit [Accelerated Graphics Port \(AGP\)](#), 32-bit PCI bus and 64-bit advanced high performance DRAM. Because of its powerful features, CPU Front Side Bus (FSB) of DX37Plus-U can operate easily at 100 and at 133MHz This chipset also supports Ultra DMA 33/66/100 EIDE, USB and keyboard/ PS2 Mouse interface plus RTC/CMOS on chip.

### Memory

With VIA Apollo Pro266T chipset, the DX37Plus-U can support [Double-Data-Rate \(DDR\) SDRAM](#). The DDR SDRAM interface allows zero wait state bursting between the SDRAM and the data buffers at 66/100/133MHz. The eight banks of DDR SDRAM can be composed of an arbitrary mixture of 1M/2M4M/8M/16M/32M/64Mx1GB DDR SDRAM and maximum up to 2 GB.

## Expansion Slots

Including five 32-bit PCI and one AGP Pro slots. The PCI local bus throughput can be up to 132MB/s. The Intel® AGP Pro specification provides a new level of video display sophistication and speed. The AGP Pro video cards support data transfer rates up to 1056MB/s. As DX37Plus-U include one AGP Pro expansion slot for a bus mastering AGP graphics card. For AD and SBA signaling, DX37Plus-U can supports 133MHz 2X/4X mode.

## SCSI On-board

The dual channel Adaptec 7899W chip host adapter delivers Ultra160/m SCSI data transfer rates which doubles the Ultra SCSI data transfer rate of up to 160MB/s. With two channels, it delivers a total of 320MB/s bandwidth. In addition, the AIC-7899 features a 66MHz, 64bit PCI interface that supports zero wait-state memory which also operates on 33MHz, 32bit PCI buses. It supports up to 15 devices on a 12 meters cable (or 25 meters in a point to point configuration), making it ideal for both clustering and RAID configurations.

### **Ultra DMA 33/66/100 Bus Mater IDE**

Comes with an on-board PCI Bus Master IDE controller with two connectors that supports four IDE devices in two channels, supports Ultra DMA 33/66, PIO Modes 3 and 4 and Bus Master IDE DMA Mode 4, and supports Enhanced IDE devices.

### **Intel 82550 LAN controller**

Another cost-effective feature for network solution is the integration of Intel 82550 10/100 Mbps Fast Ethernet controller which supports:

1. Advanced Configuration and Power Interface ([ACPI](#)) 1.20A based power management.
2. Wake on Magic Packet.
3. Wake on interesting packet.
4. Advanced System Management Bus (SMB) based manageability.
5. Wired for Management (WfM) 2.0 compliance.
6. IP checksum assist.
7. PCI 2.2 compliance.
8. PC99 compliance.

## Power Management/Plug and Play

The DX37Plus-U supports the power management function that conforms to the power-saving standards of the U.S. Environmental Protection Agency (EPA) Energy Star program. It also offers Plug-and-Play which helps save users from configuration problems, thus making to system more user-friendly.

## Hardware Monitoring Management

The DX37Plus-U additional feature includes hardware support for ASM (Advanced Server Management). ASM detects problems in CPU thermal condition, CPU working voltage detection ( $\pm 12V/\pm 5V/ 3.3V/1.5V$ ), and PCI bus utilization calculation. It also detects if the CPU fan or the chassis fan malfunctions.

## Super Multi-I/O

The DX37Plus-U provides two high-speed UART compatible serial ports and one parallel port with EPP and ECP capabilities. UART can also be directed from COM2 to the Infrared Module for the wireless connections.

## 2.3 Motherboard Map

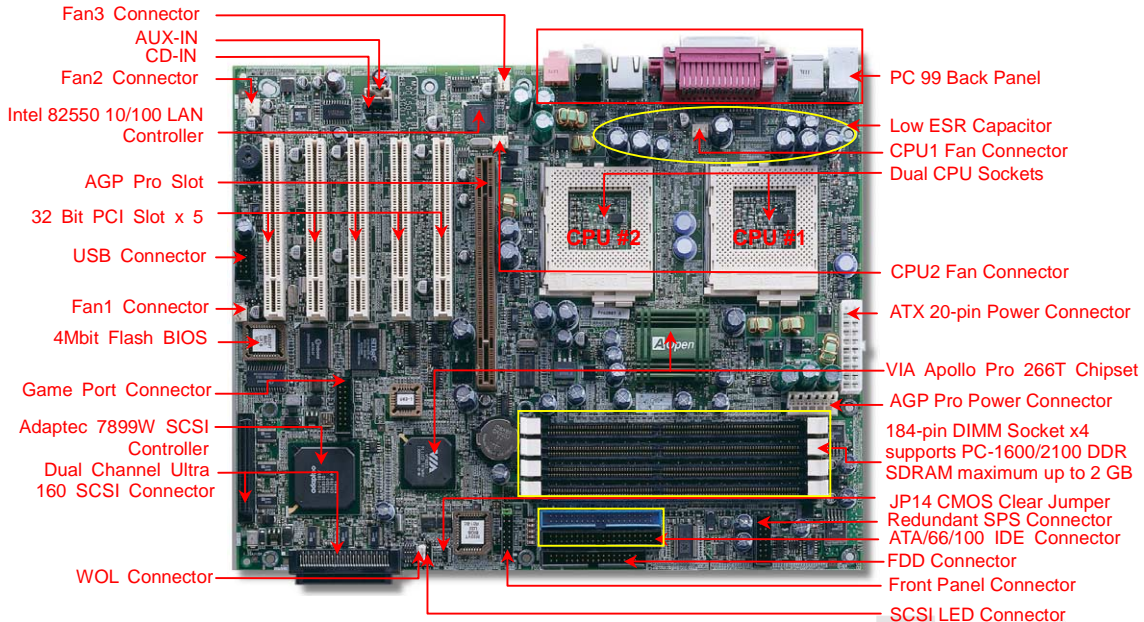

**AOpen**

## 2.4 Block Diagram

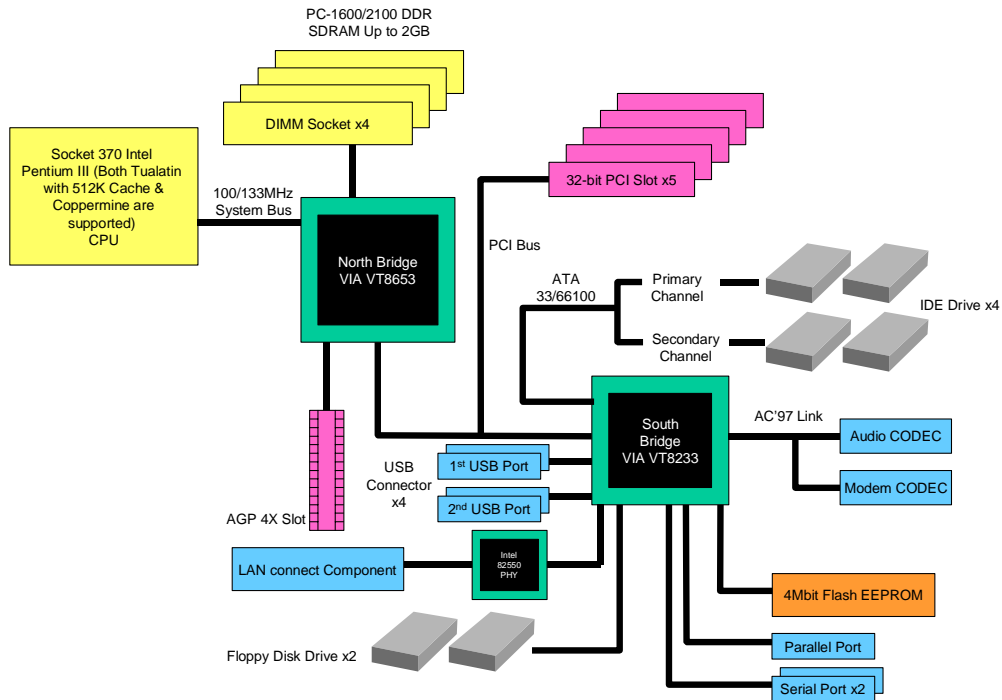



## 2.5 Connectors and Jumpers

The table below lists the different connectors or jumpers on the motherboard and their respective functions.

Connector	Function
BU1	Internal buzzer
BT1	Battery
CN1	20 pin ATX power supply connector
CN3	6 pin AUX power supply connector
CN4	Rear USB ports 1
CN6	CPU1 Fan connector
CN7-10	DIMM slots
CN11	LAN Jack (RJ-45) connector
CN16	CD-IN
CN17	CPU2 Fan connector
CN18	Fan3 connector
CN19	AGP slot
CN21	Wake on LAN connector
CN22	SCSI LED connector

Connector	Function
CN27	AUX-IN
CN28	68 pin SCSI 160 Channel B
CN30	Fan1 connector
CN31	Fan2 connector
CN32	USB 2
CN33	68pin SCSI 160 channel A
CNX2	Game port connector (16 pin)
JP14	Clear CMOS
PCI 1 to 5	32-bit PCI slot
U6	CPU 1 socket
U10	VIA Pro266T chipset (NB : VT8653)
U14	CPU 2 socket
U23	Intel 82550 LAN chipset
U32	VIA Pro266T chipset (NB : VT8233)
U44	Super IO
U46	Audio (AC97 Codec AD1885)
U47	Adaptec AIC-7899W

Connector	Function
SW1 (3)	ON : Disable SCSI Ch A Terminator
SW1 (4)	ON : Disable SCSI Ch B Terminator

## 2.6 Hardware

This chapter describes jumpers, connectors and hardware devices of this motherboard.



**Note:** *Electrostatic discharge (ESD) can damage your processor, disk drives, expansion boards, and other components. Always observe the following precautions before you install a system component.*

- 1. Do not remove a component from its protective packaging until you are ready to install it.*
- 2. Wear a wrist ground strap and attach it to a metal part of the system unit before handling a component. If a wrist strap is not available, maintain contact with the system unit throughout any procedure requiring ESD protection.*

## 2.6.1 JP14 Clear CMOS

You can clear CMOS to restore system default setting. To clear the CMOS, follow the procedure below.

1. Turn off the system and unplug the AC power.
2. Remove ATX power cable from connector PWR2.
3. Locate JP14 and short pins 2-3 for a few seconds.
4. Return JP14 to its normal setting by shorting pin 1 & pin 2.
5. Connect ATX power cable back to connector PWR2.



Normal  
(default)



Clear CMOS

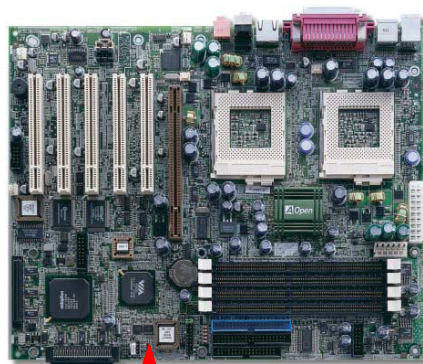

## 2.6.2 CPU Installation

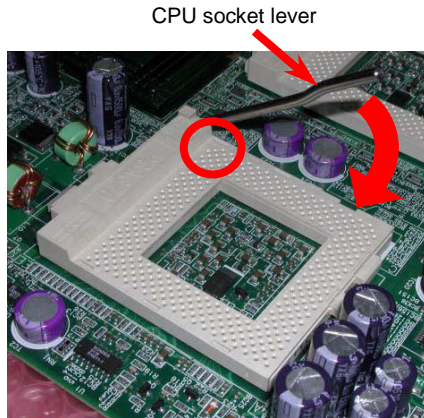

1. Pull up the CPU socket level and up to 90-degree angle.
2. Locate Pin 1 in the socket and look for a (golden) cut edge on the CPU upper interface. Match Pin 1 and cut edge. Then insert the CPU into the socket.
3. Press down the CPU socket level and finish CPU installation.

**Note:** If you do not match the CPU socket Pin 1 and CPU cut edge well, it may damage the CPU.

### 2.6.3 CPU & Housing Fan Connector

Plug in the CPU fan cable to the 3-pin **CPU1 FAN** and **CPU2 FAN** connector. If you have chassis fan, you can also plug it on **System FAN** (FAN2) or **AUX FAN** (FAN3) connector.

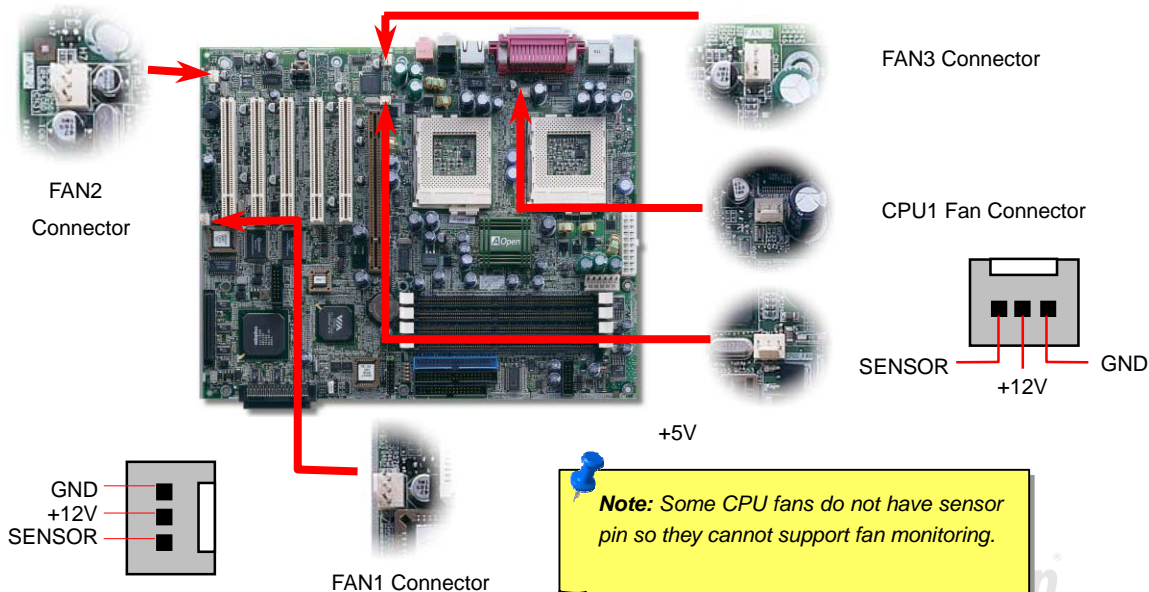

### 2.6.4 Supported CPU Type

The DX37Plus-U supports Intel® Socket 370 Pentium III series CPU. Including the code name Tualatin 512K cache CPU for dual CPU configuration.

	Processor Name	CPU Package
Single Processor	PentiumII	All
	Pentium !!!	All
Dual Processor	Pentium II	All
	Pentium !!!	Coppermine
	Pentium !!! 512K	Tualatin



## 2.6.5 Setting CPU Voltage and Frequency

### Setting CPU Core Voltage

This motherboard supports CPU VID function. The CPU core voltage will be automatically detected and the range is from 1.05V to 1.825V. It is not necessary to set CPU Core Voltage

### Setting CPU Frequency

This motherboard is CPU jumper-less design, you can set CPU frequency through the BIOS setup, no jumpers or switches are needed.

**BIOS Setup > Frequency / Voltage Control > CPU Speed Setup**

**Core Frequency = CPU FSB Clock \* CPU Ratio**

<b>CPU Ratio</b>	3x, 3.5x, 4x, 4.5x, 5x, 5.5x, 6x, 6.5x, 7x, 7.5x, 8x, 8.5x, 9x, 9.5x, 10x, 10.5x, 11x, 11.5x, 12x, 12.5x, 13x, 13.5x, 14x, 14.5x, 15x, 15.5x and 16x
<b>CPU <u>FSB</u> (By BIOS Table)</b>	100 and 133 MHz

CPU	CPU Core Frequency	FSB Clock	Ratio
Pentium III 600E	600MHz	100MHz	6x
Pentium III 650E	650MHz	100MHz	6.5x
Pentium III 700E	700MHz	100MHz	7x
Pentium III 750E	750MHz	100MHz	7.5
Pentium III 800E	800MHz	100MHz	8x
Pentium III 850E	850MHz	100MHz	8.5x
Pentium III 533EB	533MHz	133MHz	4x
Pentium III 600EB	600MHz	133MHz	4.5x
Pentium III 667EB	667MHz	133MHz	5x
Pentium III 733EB	733MHz	133MHz	5.5
Pentium III 800EB	800MHz	133MHz	6x
Pentium III 866EB	866MHz	133MHz	6.5
Pentium III 933EB	933MHz	133MHz	7x
Pentium III 1G	1GHz	133MHz	7.5x
Pentium III 1.13G	1.13GHz	133MHz	8.5x
Pentium III 1.26G	1.26GHz	133MHz	9x

## 2.6.6 DIMM Socket

This motherboard has four 184-pin [DIMM sockets](#) that allow you to install PC1600 or PC2100 memory up to 2GB.

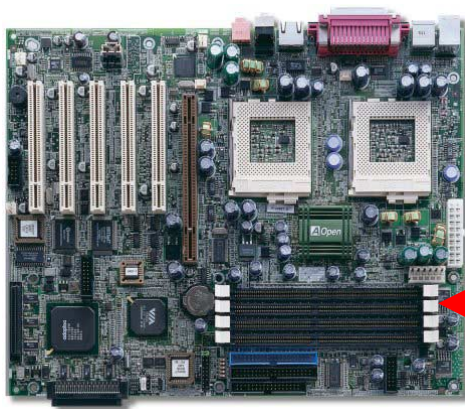

DIMM 1  
DIMM 2  
DIMM 3  
DIMM 4

## 2.6.7 ATX Power Connector and AGP Pro Power Connector

The DX37Plus-U uses Intel® SSI (Server System Infrastructure) type 24-pin ATX power connector. The 6-pin AGP Pro Power connector provides extra +5V and +3.3V power for AGP Pro VGA card. Make sure you plug in the right direction.

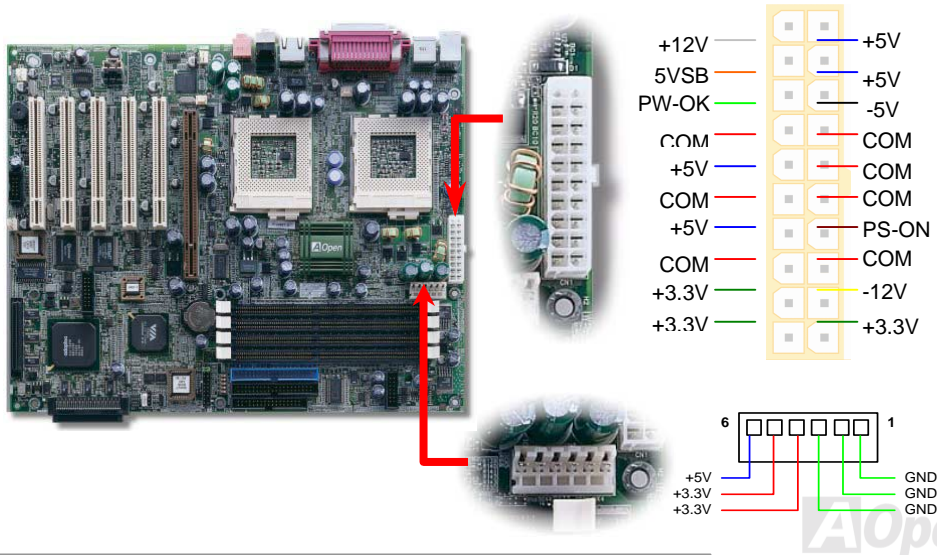

## 2.6.8 Redundant SPS Monitoring Connector

This motherboard implements Redundant SPS monitoring connector to provide hardware monitoring signals. It is feasible to install an additional 337-watt power supply module (optional with AOpen Server Housing) in a hot swappable configuration. If any SPS failed, a signal will be sent to a hardware monitoring device.



	14	13	
+12V			Fan 3 Fail
Present 3			PS 3 Fail
GND			PS ON
5VSB			Present1
Present 2			i <sup>2</sup> C CLK
Fan 2 Fail			Fan 1 Fail
PS 2 Fail			PS1 Fail
	2	1	

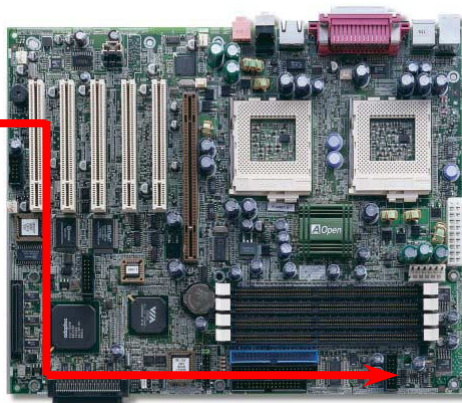

## 2.6.9 IDE and Floppy Connector

Connect 34-pin floppy cable and 40-pin ATA66 or ATA33 IDE cable to floppy connector FDC and IDE connector **IDE1**, **IDE2**. Pin1 of cable is normally marked with red color. Be careful of the pin1 orientation. Wrong orientation may cause system damage.

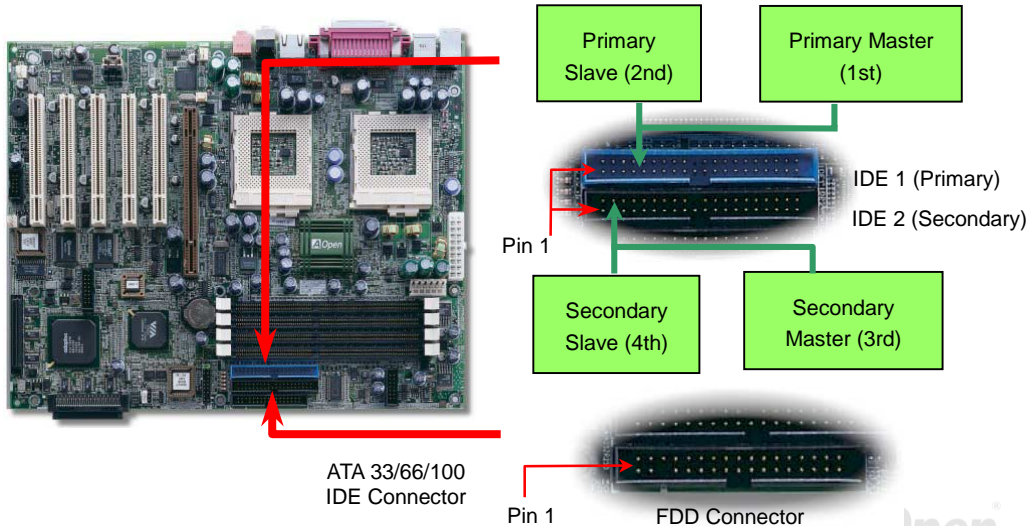

IDE1 is also known as the primary channel and IDE2 as the secondary channel. Each channel supports two IDE devices that make a total of four devices. In order to work together, the two devices on each channel must be set differently to **Master** and **Slave** mode. Either one can be the hard disk or the CDROM. The setting as master or slave mode depends on the jumper on your IDE device, so please refer to your hard disk and CDROM manual accordingly.



**Warning:** *The specification of the IDE cable is a maximum of 46cm (18 inches), make sure your cable does not exceed this length.*



**Tip:** *For better signal quality, it is recommended to set the far end side device to master mode and follow the suggested sequence to install your new device. Please refer to above diagram.*

This motherboard supports [Ultra DMA/33](#) or [Ultra DMA/66/100](#) mode. Following table lists the transfer rate of IDE PIO and DMA modes. The IDE bus is 16-bit, which means every transfer is two bytes.

Mode	Clock 33MHz PCI	Clock Count	Cycle Time	Data Transfer Rate
PIO mode 0	30ns	20	600ns	(1/600ns) x 2byte = 3.3MB/s
PIO mode 1	30ns	13	383ns	(1/383ns) x 2byte = 5.2MB/s
PIO mode 2	30ns	8	240ns	(1/240ns) x 2byte = 8.3MB/s
PIO mode 3	30ns	6	180ns	(1/180ns) x 2byte = 11.1MB/s
PIO mode 4	30ns	4	120ns	(1/120ns) x 2byte = 16.6MB/s
DMA mode 0	30ns	16	480ns	(1/480ns) x 2byte = 4.16MB/s
DMA mode 1	30ns	5	150ns	(1/150ns) x 2byte = 13.3MB/s
DMA mode 2	30ns	4	120ns	(1/120ns) x 2byte = 16.6MB/s
UDMA/33	30ns	4	120ns	(1/120ns) x 2byte x2 = 33MB/s
UDMA/66	30ns	4	120ns	(1/120ns) x 2byte x4 = 66MB/s

**Note:** ATA/100 uses both rising edge and falling edge but doubles [UDMA/33](#) transfer rate. The data transfer rate is 4 times of the PIO mode 4 or DMA mode 2, 16.6MB/s x4 = 66MB/s. To use ATA/66, you need special ATA/66 IDE cable.



### 2.6.10 68-pin Ultra 160 SCSI Connector

The DX37Plus-U provides two 68-pin Ultra Wide/Ultra 2/3 SCSI connectors for 16-bit or 16-bit differential SCSI devices.

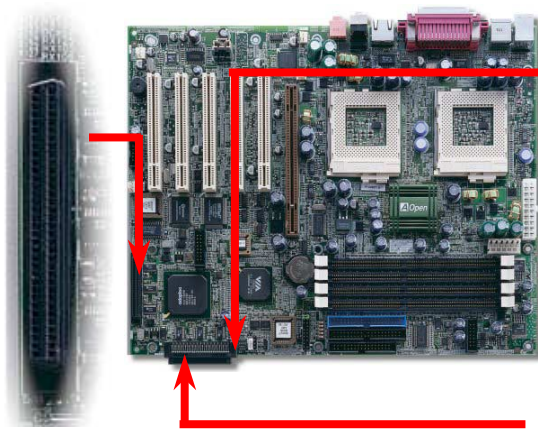

A Terminator

<b>SW1(3)</b>	On	Disable SCSI Ch A Terminator
<b>SW1(4)</b>	On	Disable SCSI Ch B Terminator



B Terminator

## 2.6.11 Front Panel Connector

Attaching such as power LED, speaker, reset switch, power switch connector, etc.... to corresponding pins. The green cap on pin 19 & 20 is to disable Chassis Intrusion Switch, you may just take it off to able this function.

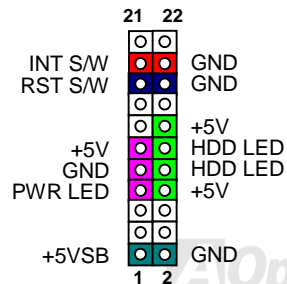
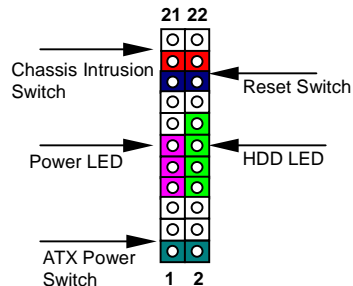
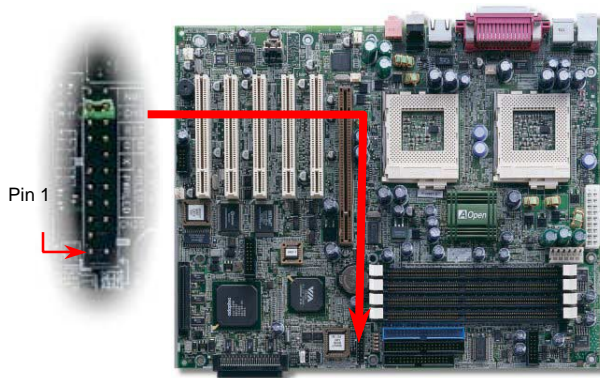

### 2.6.12 WOL (Wake on LAN)

To use Wake On LAN function, you must have a network card with chipset that supports this feature, and connect a cable from LAN card to motherboard WOL connector. The system identification information (probably IP address) is stored on network card and because there is a lot of traffic on the Ethernet, you need to install a network management software, such as ADM, for the checking of how to wake up the system. Note that, at least 600mA ATX standby current is required to support the LAN card for this function.

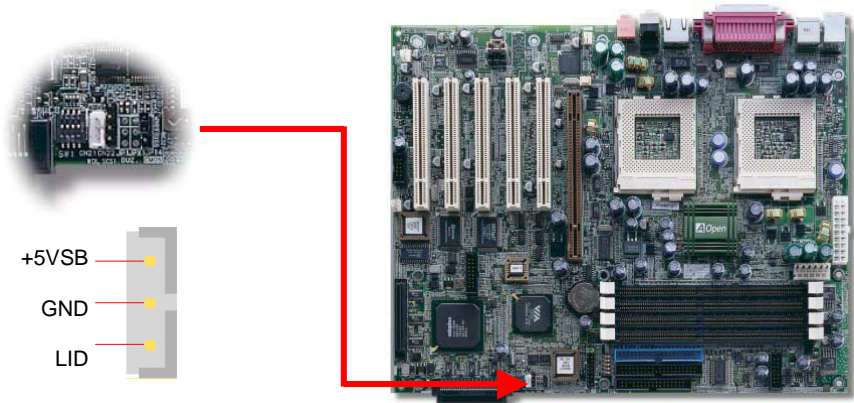

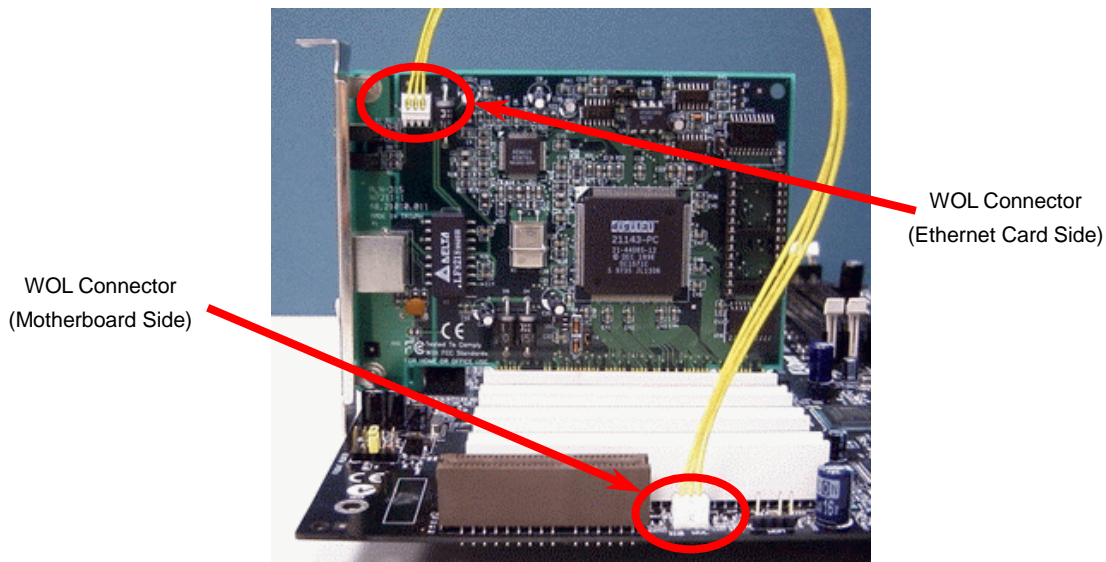

### 2.6.13 Support 4 USB Connectors

This motherboard provides four [USB](#) connectors to connect USB devices, such as mouse, keyboard, modem, printer, etc. There are two connectors on the PC99 back panel. You can use proper cable to connect other USB connectors to the back panel or front panel of chassis.

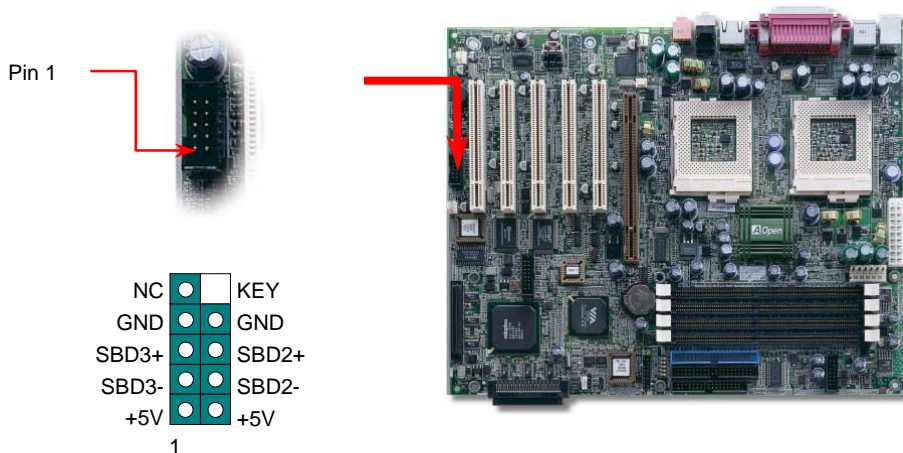

### 2.6.14 SCSI LED Connector (For SCSI/RAID Card Only)

The 4-pin SCSI LED connector can be connected to a PCI SCSI control card activity LED connector. Read or write activity by devices connected to the SCSI card will transfer a signal to Front Panel and thus making the LED lighting up.

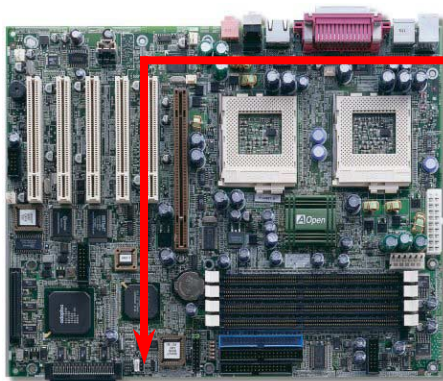

SCSI Card

### 2.6.15 CD/AUX Connector

The **AUX-IN** connector is used to connect MPEG Audio cable from MPEG card to onboard sound.

The **CD-IN** connector is used to connect CD Audio cable from CDROM or DVD drive to onboard sound.

CD-IN (Black)

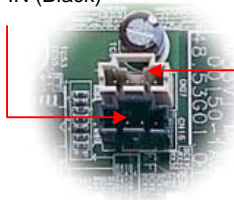

AUX-IN  
(Gray)

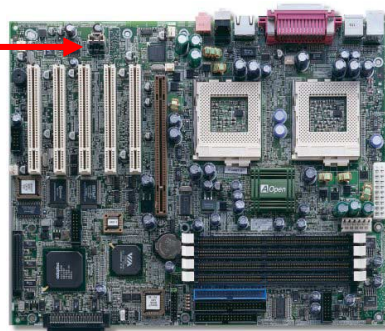

Connector	Pin1	Pin2	Pin3	Pin4
AUX-IN	Left	GND	GND	Right
CD-IN	Left	GND	GND	Right

### 2.6.16 PC99 Color Coded Back Panel

The onboard I/O devices are PS/2 Keyboard, PS/2 Mouse, serial ports COM1 and COM2, Printer, [USB](#), RJ45 LAN. The view angle of drawing shown here is from the back panel of the housing.

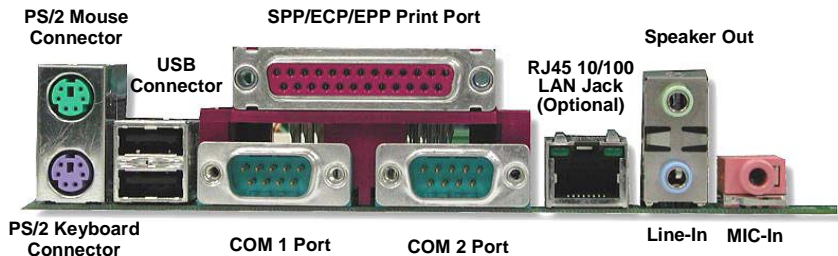
**PS/2 Keyboard:**

For standard keyboard, which is using a PS/2 plug.

**PS/2 Mouse:**

For PC-Mouse, which is using a PS/2 plug.

**USB Port:**

Available for connecting USB devices.

**Parallel Port:**

To connect with SPP/ECP/EPP printer.

**COM1 Port:**

To connect with pointing devices, modem or others serial devices.



### 2.6.17 Support 10/100 Mbps LAN onboard

The South Bridge V8233 of VIA Apollo Pro266T chipset includes a fast Ethernet controller on chip. On the strength of Intel 82550 PHY on board, which is a highly-integrated Platform LAN Connect device, it provides 10/100 Mbps Ethernet for office and home use, the Ethernet RJ45 connector is located on the back panel. The green LED indicates the link mode, it lights when linking to network and blinking when transferring data. The orange LED indicates the transfer mode, and it lights when data is transferring in 100Mbps mode. To enable or disable this function, you may simply adjust it through BIOS.

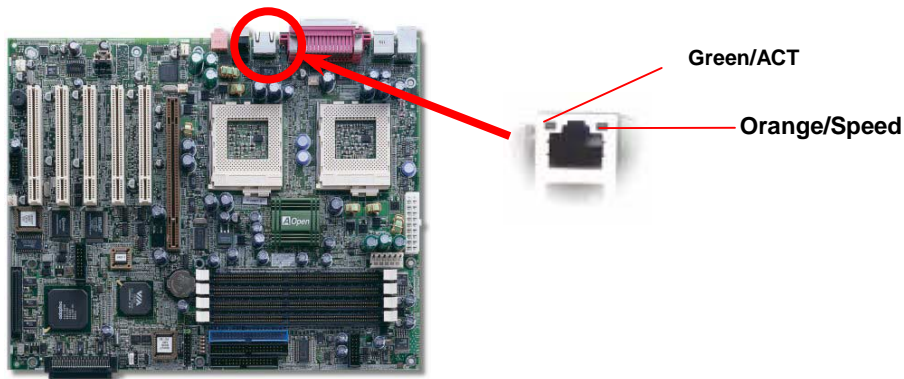

### 2.6.18 Low ESR Capacitor

The quality of low ESR capacitor (Low Equivalent Series Resistor) during high frequency operation is very important for stability of CPU power. The location of where to put these capacitors is another knowhow that requires experience and detail calculation.

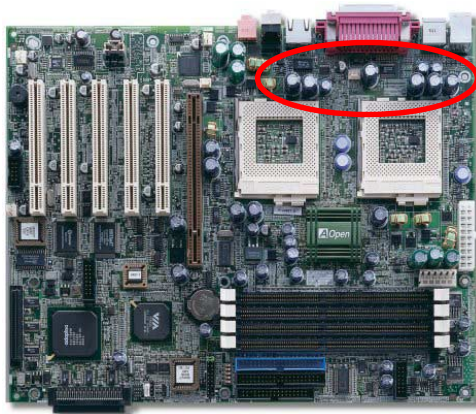

## Chapter 3 BIOS Setup Utility

Most of system had already configured by the manufacturer or the dealer. There is no need to run BIOS setup program when starting the computer unless you get a run setup program message.

The setup program loads configuration values into the battery-backed nonvolatile memory called CMOS RAM. This memory area is not part of the system RAM.



***If you repeatedly receive Run Setup messages, the battery may be bad. In this case, the system cannot retain configuration values in CMOS. Ask a qualified technician for assistance.***

The system will reboot immediately after you exit Setup.

## 3.1 Entering Setup

To enter Setup, press the DELETE key.



***You must press DELETE while the system is booting.  
This key does not work during any other time.***

The Setup Utility Main Menu appears:

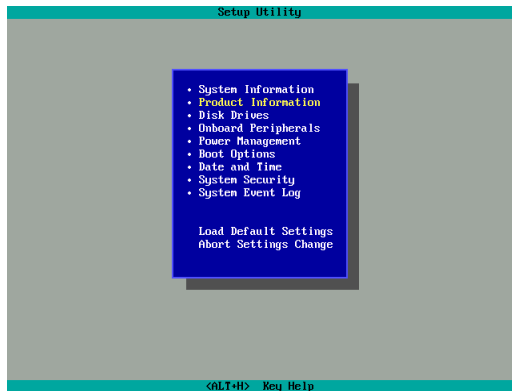

The system supports two BIOS Utility levels: Basic and Advanced.

If you are an advanced user, you may want to check the detailed configuration of your system. Detailed system configurations are contained in the Advanced Level. To view the Advanced Level, press **F8**.



***The asterisk (\*) mark indicates that the parameter appears only when you are in the Advanced Level.***

***The parameters on the screens show default values. These values may not be the same as those in your system.***

***The grayed items on the screens have fixed settings and are not user-configurable.***

Use the arrow keys **↑** and **↓** to move around the Setup Utility screen.

Use **←** to move to the next page or **→** to return to the previous page if the setup screen has more than one page available.

Use **PGUP**, **PGDN**, “+” or “-” to select the options if they are available.

Press **ESC** to return to the Main menu.

## 3.2 System Information

The following screen appears if you select System Information from the Main menu:

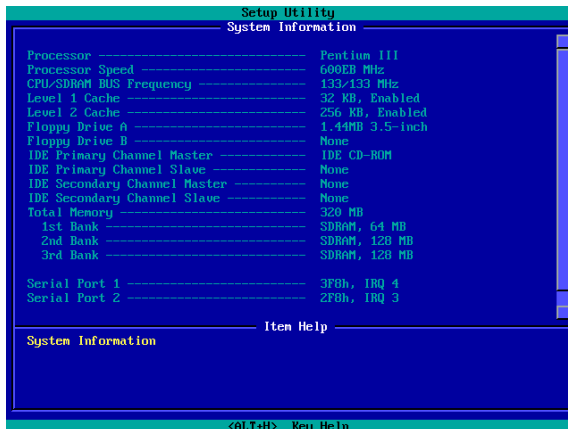

The System Information menu shows the current basic configuration of your system.

The sections below explain the parameters.

### **3.2.1 Processor**

The Processor parameter specifies the type of processor currently installed in your system. The system supports Intel Pentium® II and Pentium® III processors.

### **3.2.2 Processor Speed**

The Processor Speed parameter specifies the speed of the processor currently installed in your system.

### **3.2.3 CPU/SDRAM BUS Frequency**

This parameter specifies the currently FSB (Front Side Bus) frequency of the CPU/SDRAM.

### **3.2.4 Level 1 Cache**

This parameter specifies the first-level or the internal fast accessed memory (i.e., the memory integrated into the CPU) size, and whether it is enabled or disabled.

### **3.2.5 Level 2 Cache**

This parameter specifies the second-level cache memory size that comes with the CPU. The available cache size is 256/512 KB.

### **3.2.6 Diskette Drive A**

This parameter specifies the system's current diskette drive A settings.

### **3.2.7 Diskette Drive B**

This parameter specifies the system's current diskette drive B settings.

### **3.2.8 IDE Primary Channel Master**

This parameter specifies the current configuration of the IDE device connected to the master port of the primary IDE channel.



### 3.2.9 IDE Primary Channel Slave

This parameter specifies the current configuration of the IDE device connected to the slave port of the primary IDE channel.

### 3.2.10 IDE Secondary Channel Master

This parameter specifies the current configuration of the IDE device connected to the master port of the secondary IDE channel.

### 3.2.11 IDE Secondary Channel Slave

This parameter specifies the current configuration of the IDE device connected to the slave port of the secondary IDE channel.

### 3.2.12 Total Memory

This parameter specifies the total amount of onboard memory. The memory size is automatically detected by BIOS during the POST. If you install additional memory, the system automatically adjusts this parameter to display the new memory size.

**1st Bank/2nd Bank/3rd Bank**

The 1st Bank, 2nd Bank, and 3rd Bank parameters indicate the type and size of DRAM installed in DIMM sockets 1, 2, and 3 respectively. The “None” setting indicates that there is no DRAM installed. For the location of the DIMM sockets, refer to section 2.3 or 2.4.

### 3.2.13 Serial Port 1

This parameter shows the serial port 1 address and IRQ setting.

### 3.2.14 Serial Port 2

This parameter shows the serial port 2 address and IRQ setting.

### 3.2.15 Parallel Port

This parameter shows the parallel port address and IRQ setting.

### 3.2.16 PS/2 Mouse

The BIOS utility automatically detects if there is a pointing device connected to your system. If there is, this parameter displays the “**Installed**” setting. Otherwise, this is set to “None”.

### 3.3 Product Information

The Product Information contains the general data about the system, such as the product name, serial number, BIOS version, etc. This information is necessary for troubleshooting (may be required when asking for technical support).

The following shows how the Product Information screen appears:



### **3.3.1 Product Name**

This parameter specifies the official name of the system.

### **3.3.2 System S/N**

This parameter specifies the system's serial number.

### **3.3.3 Main Board ID**

This parameter specifies the motherboard's identification number.

### **3.3.4 Main Board S/N**

This parameter specifies the motherboard's serial number.

### **3.3.5 System BIOS Version**

This parameter specifies the version of the BIOS utility.

### **3.3.6 SMBIOS Version**

This parameter specifies the version of the SMBIOS version.

## 3.4 Disk Drives

Select Disk Drives to input configuration values for disk drives.

The following screen shows the Disk Drives menu:

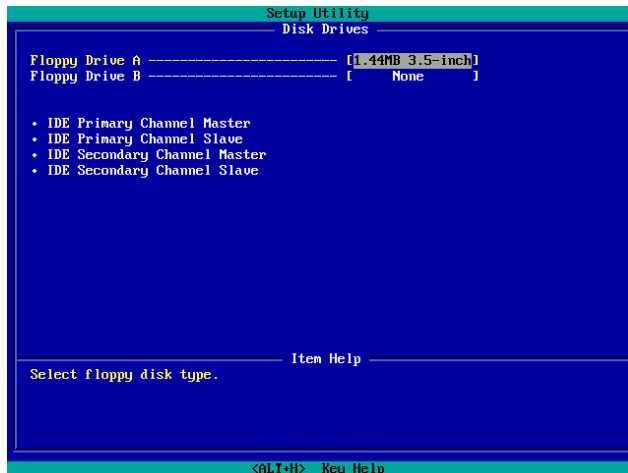

### 3.4.1 Floppy Drives

To enter the configuration value for the first floppy drive, highlight the Floppy Drive A parameter. Press **PGUP** or **PGDN** key to view the options and select the appropriate value.

**Drive A/Drive B**

None  
360KB 5.25"  
1.2MB 5.25"  
720KB 3.5"  
1.44MB 3.5"  
2.88MB 3.5"

These items select the floppy drive type. The available settings and types supported by the motherboard are listed to the left.

Follow the same procedure to configure floppy drive B. Choose **"None"** if you do not have a second floppy drive.

### 3.4.2 IDE Drives

To configure the IDE drives connected to your system, select the parameter that represents the channel and port where the desired hard disk to configure is connected. The options are:

**IDE Primary Channel Master**

This option lets you configure the hard disk drive connected to the master port of IDE channel 1.

### IDE Primary Channel Slave

This option lets you configure the hard disk drive connected to the slave port of IDE channel 1.

### IDE Secondary Channel Master

This option lets you configure the hard disk drive connected to the master port of IDE channel 2.

### IDE Secondary Channel Slave

This option lets you configure the hard disk drive connected to the slave port of IDE channel 2.

The following screen appears if you select any of the IDE Drive parameters:

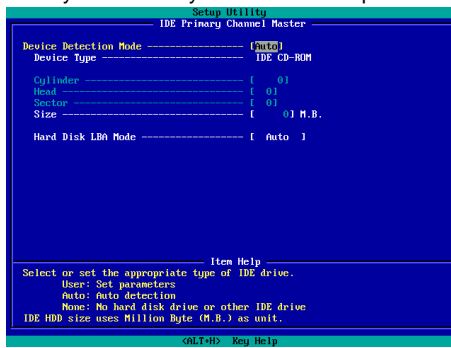



## Device Detection Mode

<b>Device Detection Mode</b>
------------------------------

Auto (Default)
Manual
None

If you select "Manual", you need to fill in all remaining field, such as Cylinder, Head, and Sector on this selected item. If the item "Auto" is selected, the items will remain "0". And when the system boot up, system will detect the hard disk and configure it automatically. "None" means there is no device in the channel.

## Device Type

This parameter shows which type of IDE drive currently used.

## Cylinder

This parameter specifies the number of cylinders of your hard disk, and is automatically set depending on your Type parameter setting.

## Head

This parameter specifies the number of heads of your hard disk, and is automatically set depending on your Type parameter setting.

## Sector

This parameter specifies the number of sectors of your hard disk, and is automatically set depending on your Type parameter setting.

## Size

This parameter specifies the size of your hard disk, in MB.

## Hard Disk LBA Mode

<b><u>Hard Disk Block Mode</u></b>
------------------------------------

Auto (Default)
----------------

Disabled
----------

This function enhances disk performance depending on the hard disk in use. If you set this parameter to “**Auto**”, the BIOS utility automatically detects if the installed hard disk drive supports the Block Mode function. If supported, it allows data transfer in blocks (multiple sectors) at a rate of 256 bytes per cycle. To disregard the feature, change the setting to “**Disable**”.

## 3.5 Onboard Peripherals

The Onboard Peripheral Configuration allows you to configure the onboard communication ports and the onboard devices. Selecting this option displays the following screen:

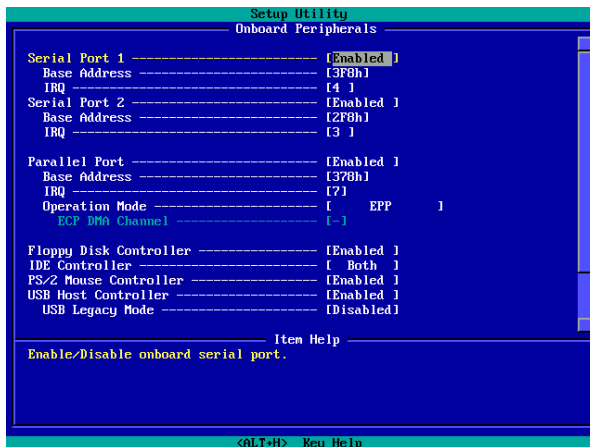

### 3.5.1 Serial Ports 1 and 2

**Serial Port 1 & 2**

Enabled (Default)

Disabled

These parameters allow you to enable or disable serial ports 1 and 2.

#### 3.5.1.1 Base Address

**Base Address**

Serial Port 1:

3F8h (Default)

3E8h

2E8h

Serial Port 2:

2F8h (Default)

2E8h

3E8h

This item allows you to assign address and interrupt for the board serial port.

### 3.5.1.2 IRQ

**IRQ**

Serial Port 1:  
4 (Default), 11  
Serial Port 2:  
3 (Default), 10

This function lets you assign an interrupt for serial ports 1 and 2. The options for serial ports 1 are IRQ 4 and 11. The options for serial port 2 are IRQ 3 and 10.



The Base Address and IRQ parameters for each port are configurable only if the port is enabled.

### 3.5.2 Parallel Port

**Parallel Port**

Enabled (Default)  
Disabled

This parameter allows you to enable or disable the parallel port.

### 3.5.2.1 Base Address

**Base Address**

378h (Default)

3BCh

278h

This item allows you to assign address and interrupt for the board serial port.

### 3.5.2.2 IRQ

**IRQ**

7 (Default), 5

This function lets you assign an interrupt for the parallel port. The options are IRQ 5 and 7.



The Base Address and IRQ parameters are configurable only if Parallel Port is enabled.

If you install an add-on card that has a parallel port whose address conflicts with the onboard parallel port, a warning appears on the screen.

Check the parallel port address of the add-on card and change the address to one that does not conflict.

**3.5.2.3 Operation Mode****Operation Mode**

EPP (Default)

Bi-Directional

Standard

ECP

This item lets you set the parallel port mode. The mode options are Standard, Bi-directional, EPP (Enhanced Parallel Port) and ECP (Extended Parallel Port).

Setting	Function
Standard Parallel Port (Standard)	Allows normal speed one-way operation
Bi-directional Parallel Port (Bi-directional)	Allows normal speed operation in a two-way mode
Enhanced Parallel Port (EPP)	Allows bi-directional parallel port operation at maximum speed
Extended Capabilities Port (ECP)	Allows parallel port to operate in bi-directional mode and at a speed higher than the maximum data transfer rate

### 3.5.2.4 ECP DMA Channel

**ECP Mode Use DMA**

3

1 (Default)

This item becomes active only if you select Extended Capabilities Port (ECP) as the operation mode. It allows you to assign DMA channel 1 or DMA channel 3 for the ECP parallel port function (as required in Windows 95).

### 3.5.3 Onboard Device Settings

The Onboard Device Settings menu allows you to configure the onboard communication ports and the onboard devices. Selecting this option from the Onboard Peripherals menu displays the following screen:

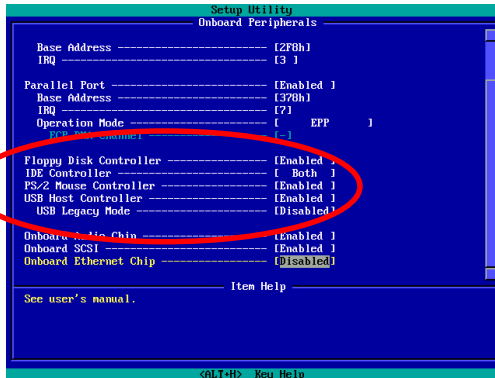



### 3.5.3.1 Floppy Disk Controller

<b><u>Floppy Disk Controller</u></b>
------------------------------------------

Enabled (Default)
-------------------

Disabled
----------

This parameter lets you enable or disable the onboard floppy disk controller.

### 3.5.3.2 IDE Controller

<b><u>IDE Controller</u></b>
------------------------------

Both (Default)
----------------

Primary
---------

Disabled
----------

Set this parameter to **“Primary”** to enable only the primary IDE controller; **“Both”** to enable both primary and secondary IDE controllers; or **“Disabled”** to disable all IDE controllers.

### 3.5.3.3 PS/2 Mouse Controller

<b><u>PS/2 Mouse Controller</u></b>
-----------------------------------------

Enabled (Default)
-------------------

Disabled
----------

This parameter enables or disables the onboard PS/2 mouse controller.

#### 3.5.3.4 USB Host Controller

<b>USB Host Controller</b>
--------------------------------

Enabled (Default)
-------------------

Disabled
----------

This parameter lets you enable or disable the USB controller on board. When enabled, it activates the USB function of the system. When disabled, it deactivates the function.

#### 3.5.3.5 USB Legacy Mode

<b>USB Legacy Mode</b>
------------------------

Enabled
---------

Disabled (Default)
--------------------

This parameter lets you enable or disable the USB controller on board. When enabled, it activates the USB function of the system. When disabled, it deactivates the function.

#### 3.5.3.6 On-board Audio Chip

<b>On-board Audio Chip</b>
--------------------------------

Enabled (Default)
-------------------

Disabled
----------

This parameter lets you enable or disable the on-board audio chip. When enabled, it activates the audio function of the system. When disabled, it deactivates the function.

### 3.5.3.7 On-board SCSI

**On-board SCSI**

Enabled (Default)

Disabled

This parameter lets you enable or disable the SCSI controller on board. When enabled, it activates the SCSI function of the system. When disabled, it also deactivates the function.

### 3.5.3.8 Onboard Ethernet Chip

**On-board  
Ethernet Chip**

Enabled

Disabled (Default)

This parameter allows you to enable or disable the onboard network feature.

## 3.6 Power Management

The Power Management menu allows you to configure the system power-management feature.

The following screen shows the Power Management parameters and their default settings:

```
Setup Utility
Power Management

Power Management Mode ----- [Enabled ]
IDE Hard Disk Standby Timer ----- [OFF]
System Sleep Timer ----- [OFF]
Sleep Mode ----- [-----]

Power Switch < 4 sec. ----- [Power Off]

System wake-up event
Modem Ring Indicator ----- [Enabled ]
PCI Power Management ----- [Enabled ]
RTC Alarm ----- [Disabled ]
Resume Day ----- [---]
Resume Time ----- [---:---:---]
Restart on AC/Power Failure ----- [Disabled]

----- Item Help -----
Select <Enabled> to reduce power consumption or <Disabled> to
deactivate the power management features and timers.

----- <ALT+H> Key Help -----
```

### 3.6.1 Power Management Mode

**Power  
Management  
Mode**

Enabled (Default)  
Disabled

This parameter allows you to reduce power consumption. When this parameter is set to **“Enabled”**, you can configure the IDE hard disk and system timers. Setting it to **“Disabled”** deactivates the power-management feature and its timers.

#### 3.6.1.1 IDE Hard Disk Standby Timer

**IDE Hard Disk  
Standby Timer**

Off (Default)  
1 to 15min

This parameter allows the hard disk to enter standby mode after inactivity of **1 to 15** minutes, depending on your setting. When you access the hard disk again, allow 3 to 5 seconds (depending on the hard disk) for the disk to return to normal speed. Set this parameter to **“Off”** if your hard disk does not support this function.

### 3.6.1.2 System Sleep Timer

<b><u>System Sleep Timer</u></b>
--------------------------------------

Off (Default) 120, 110, 100...20, 15, 10, 5, 2min
---------------------------------------------------------

This parameter sets the system to the lowest power-saving mode after a specified period of inactivity. Any keyboard or mouse action or any activity detected from the IRQ channels resumes system operation.

### 3.6.1.3 Sleep Mode

<b><u>Sleep Mode</u></b>
--------------------------

Standby Suspend (Default)
------------------------------

This parameter lets you specify the power-saving mode that the system will enter after a specified period of inactivity. The options are “**Standby**” and “**Suspend**” modes. This parameter becomes configurable only if the System Sleep Timer is enabled. Any keyboard or mouse action, or any enabled monitored activities occurring through the IRQ channels resume system operation.

### 3.6.2 Power Switch < 4 sec.

<b><u>Power Switch &lt; 4 Sec.</u></b>
----------------------------------------

Suspend
---------

Power Off (Default)
---------------------

When set to "**Power Off**", the system automatically turns off when the power switch is pressed for less than 4 seconds.

When set to "**Suspend**", the system enters the suspend mode when pressed for less than 4 seconds.

### 3.6.3 System Wake-up Event

The system wake-up event allows the system to resume operation when the modem ring indicator is enabled.

#### 3.6.3.1 Modem Ring Indicator

<b><u>Modem Ring Indicator</u></b>
------------------------------------

Enabled
---------

Disabled (Default)
--------------------

When "**Enabled**" any fax/modem activity wakes up the system from suspend mode. The default setting is "**Disabled**".

### 3.6.3.2 PCI Power Management

**PCI Power Management**

Enabled (Default)

Disabled

This item allows you to enable or disable the PCI power management function.

### 3.6.3.3 RTC Alarm

**RTC Alarm**

Enabled

Disabled (Default)

This item allows you to set a certain time on a certain day to wake-up the system from suspend mode.

### Resume Day

**Resume Day**

1 to 31

This item is displayed when you enable the “RTC Timer” option. Here you can specify what date you want to wake up the system. For example, setting to 15, the system will wake up on the 15<sup>th</sup> day of every month.



**Resume Time****Resume Time**

hh:mm:ss

This item is displayed when you enable the RTC Wake Up Timer option. Here you can specify what time you want to wake up the system.

**3.6.3.4 Restart On AC/Power Failure****Restart On  
AC/Power Failure**Enabled  
Disabled (Default)

A traditional ATX system should remain at power off stage when AC power resume from power failure. This design is inconvenient for a network server or workstation, without an UPS, that needs to keep power-on. The system will remain power-off if you select “**Disabled**”. Selecting “**Enabled**” to enable system automatically power-on after power failure.

## 3.7 Boot Options

This option allows you to specify your preferred setting for boot up.

The following screen appears if you select Boot Options from the Basic Configuration menu:

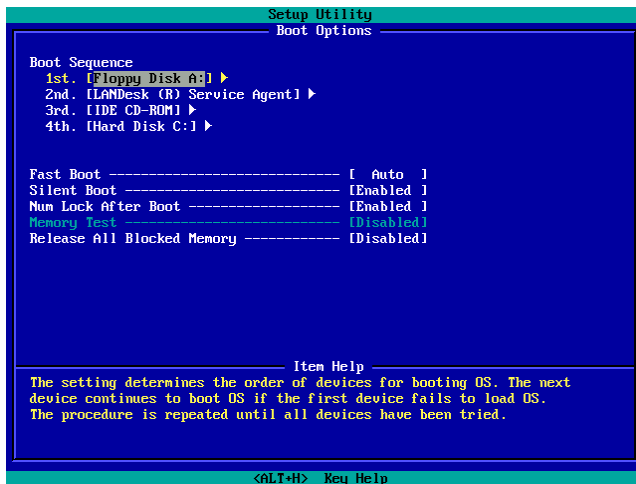

### 3.7.1 Boot Sequence

This parameter allows you to specify the boot search sequence during POST.

- 1<sup>st</sup>. The system checks this drive first.
- 2<sup>nd</sup>. The system then checks this drive if it can not boot from the 1<sup>st</sup> specified drive.
- 3<sup>rd</sup>. If the 1<sup>st</sup> and 2<sup>nd</sup> searches fail then it boots from this drive.
- 4<sup>th</sup>. If the 1<sup>st</sup>, 2<sup>nd</sup>, and 3<sup>rd</sup> searches fail then it boots from this drive.

BIOS will display an error message if the drive(s) specified is not bootable.

### 3.7.2 Fast Boot

**Fast Boot**

Auto (Default)

Disabled

This parameter allows the system to boot faster by skipping some POST routines.

### 3.7.3 Silent Boot

**Silent Boot**

Enabled (Default)

Disabled

This parameter enables or disables the Silent Boot function. When set to **"Enabled"**, BIOS is in graphical mode and displays only an identification logo during POST and while booting. After booting the screen displays the operating system prompt (such as DOS) or logo (such as Windows 95). If any error occurs while booting, the system automatically switches to the text mode.

Even if your setting is **"Enabled"**, you may also switch to the text mode while booting by pressing  when you see the **"Press DELETE key to enter setup"** message on the screen.

When set to **"Disabled"**, BIOS is in the conventional text mode where you see the system initialization details on the screen.

### 3.7.4 Num Lock After Boot

**Num Lock After Boot**

Enabled (Default)

Disabled

This parameter allows you to activate the Num Lock function upon booting.

### 3.7.5 Memory Test

**Memory Test**

Enabled  
Disabled (Default)

When set to "**Enabled**", this parameter allows the system to perform a RAM test during the POST routine. When set to "**Disabled**", the system detects only the memory size and bypasses the test routine.

### 3.7.6 Release All Blocked Memory

**Release All  
Blocked Memory**

Enabled  
Disabled (Default)

When set to "**Enabled**", this parameter allows system to bypass testing the defective memory banks detected earlier.

### 3.8 Date and Time

The real-time clock keeps the system date and time. After setting the date and time, you do not need to enter them every time you turn on the system. As long as the internal battery remains good (approximately seven years) and connected, the clock continues to keep the date and time accurately even when the power is off.



### 3.8.1 Date

**Date**

ww:mm:dd:yy

Highlight the items on the Date parameter and press **PGUP** or **PGDN** to set the date following the weekday-month-day-year format.

Valid values for weekday, month, day, and year are:

- Weekday: Sun, Mon, Tue, Wed, Thu, Fri, Sat
- Month: Jan, Feb, Mar, Apr, May, Jun, Jul, Aug, Sep, Oct, Nov, Dec
- Day: 1 to 31
- Year: 1980 to 2079

### 3.8.2 Time

**Time**

hh:mm:ss

Highlight the items on the Time parameter and press **PGUP** or **PGDN** to set the time following the hour-minute-second format.

Valid values for hour, minute, and second are:

- Hour 00 to 23
- Minute 00 to 59
- Second 00 to 59

## 3.9 System Security

The Setup program has a number of security features to prevent unauthorized access to the system and its data.

The following screen appears if you select System Security from the Main menu:

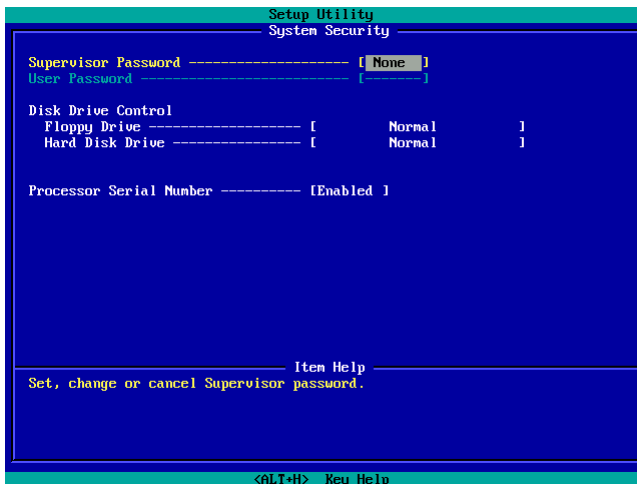



### 3.9.1 Supervisor Password

**Supervisor  
Password**

None (Default)  
Present

This item can prevent unauthorized access to the BIOS utility. The “**Present**” setting allows you to set a setup password.

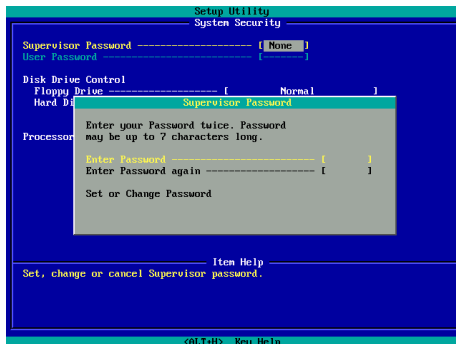

1. Enable the Supervisor Password parameter in the System Security menu by pressing the ENTER key. The Supervisor Password windows will appear as shown above.

2. Type a password. The password may consist of up to seven characters.



*Be very careful when typing your password because the actual characters do not appear on the screen.*

3. Press the ENTER key. Re-type the password to verify your first entry then press ENTER key again.
4. Highlight the **"Set or change password"** option and press ENTER key.
5. Press the ESC key to return the System Security screen.
6. Press the ESC key to exit setup. The Exit Setup screen will appear.
7. Choose **"Yes"** to save your setting and exit Setup. Your password will be saved to CMOS.
8. If you want to remove the password, please select **"Disabled"** to disable this function.

### 3.9.2 User Password

#### User Password

None (Default)

Present

This item can secure your system against unauthorized use. Once you set this password, you have to type it whenever you boot the system. This item is available when only Supervisor Password is set.

### 3.9.3 Disk Drive Control

The disk drive control features allow you to control the floppy drive or the hard disk drive boot function to prevent loading operating systems or other programs from a certain drive while the other drives are operational (under DOS mode only).

The table below lists the drive control settings and their corresponding functions.

Floppy Drive	
Setting	Description
Normal	Floppy drive functions normally
Write Protect All Sectors	Disables the write function on all sectors
Write Protect Boot Sector	Disables the write function only on the boot sector

Hard Disk Drive	
Setting	Description
Normal	Hard disk drive functions normally
Write Protect All Sectors	Disables the write function on all sectors
Write Protect Boot Sector	Disables the write function only on the boot sector

### 3.9.4 Processor Serial Number

<b>Processor Serial Number</b>
------------------------------------

Enabled (Default)
-------------------

Disabled
----------

The Pentium III processor incorporates an individual serial number in each chip that can identify individual CPUs. When enable this option, CPUs can be identified by processor serial number. Disable this option to deactivate this feature.

### 3.10 System Event Log

The system event log enables you to record and monitor events that occurs in your system like system temperature, fan stops, and others. This feature allows you to specify the appropriate settings for your system's event handling. Selecting the option displays the following screen:

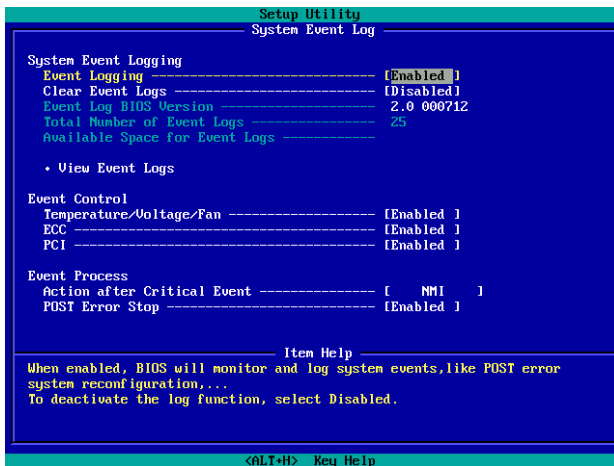

### 3.10.1 System Event Logging

This option allows you to record monitored events that occur during the operation of your system.

#### 3.10.1.1 Event Logging

**Event Logging**

Enabled (Default)

Disabled

This item allows you to enable or disable the system event logging function.

#### 3.10.1.2 Clear Event Logs

**Clear Event Logs**

Enabled

Disabled (Default)

This item allows you to enable or disable the system event logs clearing function. Please enable it if you want to clear the event log whenever the event log area is full

#### 3.10.1.2 Event Log BIOS Version

**Event Log BIOS  
Version**

This parameter specifies the version of the Event Log BIOS.

### 3.10.1.3 Total Number of Event Logs

**Total Number of Event Logs**

The currently number of events located in the event log area.

### 3.10.1.4 Available Space for Event Logs

**Available Space for Event Logs**

The percentage of space that is still available for logging system events.

### 3.10.1.5 View Event Logs

**View Event Logs**

Opens the system event log file for viewing.

## 3.10.2 Events Control

This parameter monitors the following events and logs them into the event log file if there is a change in status.

### 3.10.2.1 Temperature/Voltage/Fan

**Temperature/Voltage/Fan**

Enabled (Default)

Disabled

Enable or disable the monitoring of the system's temperature, voltage, and CPU fan.

### 3.10.2.2 ECC

**ECC**

Enabled (Default)

Disabled

ECC or Error-Correcting Code tests the accuracy of data as it passes in and out of memory. This parameter enables or disables the monitoring of this function.

### 3.10.2.3 PCI

**PCI**

Enabled (Default)

Disabled

PCI or Peripheral Component Interconnect is a 32-bit bus that can run at clock speeds of 33 MHz. This parameter monitors the activity of this bus when set to enabled.



### 3.10.3 Event Process

#### 3.10.3.1 Action After Critical Event

<u>Action</u>	<u>After</u>
<u>Critical Event</u>	
NMI (Default)	
Power Cycle	
Reset	

This parameter allows you to select the action after BIOS finds a critical event. The critical events include multiple bits ECC error and PCI device error.

#### 3.10.3.2 POST Error Stop

<u>Post Error Stop</u>
Enabled (Default)
Disabled

BIOS checking the bad CPUs and memory modules during POST. When this parameter is enabled, BIOS will stop POST operation whenever it finds a bad CPU or memory. Otherwise, if disabled the system will continue running.

## 3.11 Load Default Settings

Use this option to load the default settings for the optimized system configuration. When you load the default settings, some of the parameters are grayed-out with their fixed settings. These grayed parameters are not user-configurable.

The following dialog box appears when you select Load Default Settings from the main menu:

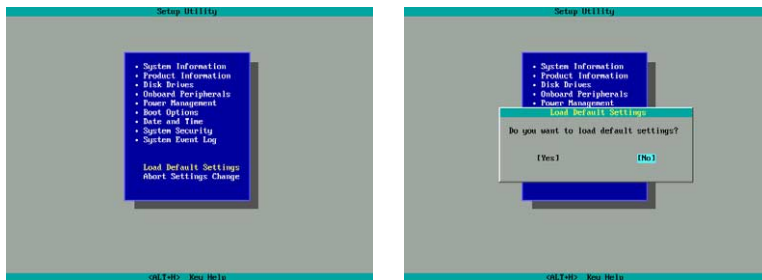

Select **“Yes”** to load the default settings.

Select **“No”** to ignore the message and return to the BIOS utility.

### 3.12 Abort Settings Change

Use this option to disregard your changes to the BIOS and reload your previous settings.

The following dialog box appears when you select Abort Settings Change from the main menu:

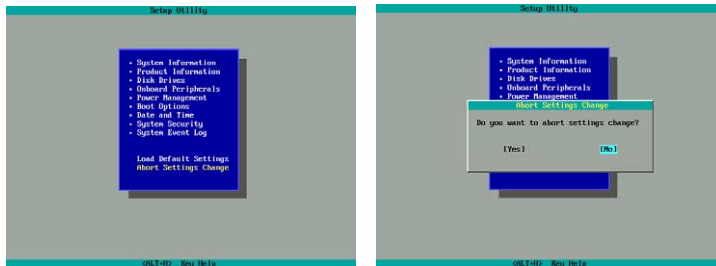

Select **“Yes”** to disregard your changes and reload your previous settings. After reload, the main menu appears on screen.

Select **“No”** to ignore the message and return to the BIOS utility.

## Chapter 4 SCSISelect™ Utility

The SCSISelect™ utility allows you to change SCSI controller settings without opening the system or changing jumpers.

The table below lists the settings that you can change using the SCSISelect™ utility and the default value for each setting. Some settings apply globally to the SCSI controller and all SCSI devices on the bus. Other settings apply individually to each device on the bus.

### Settings for the SCSI Controller and All Devices

Item	Default
Host Adapter SCSI ID	7
SCSI Parity Checking	Enabled
Host Adapter SCSI Termination	Enabled
Boot Device Option	0 (zero)
Host Adapter BIOS*	Enabled
Support Removable Disks under BIOS as Hard Disks	Boot only

\* **Some settings are valid only if the host adapter BIOS is enabled.**

Extended BIOS Translation for DOS Drives > 1 GB	Enabled
Display <Ctrl-A> Message During BIOS Initialization	Enabled
Multiple LUN Support	Disabled
BIOS Support for Bootable CD-ROM	Enabled
<b>Item</b>	<b>Default</b>
BIOS Support for Int13 Extensions	Enabled
Support for Ultra SCSI Speed	Disabled

### Individual Settings for SCSI Drives

Item	Default
Initiate Sync Negotiation	Yes
Maximum Sync Transfer Rate	160MB/sec.
Enable Disconnection	Yes
Send Start Unit SCSI Command*	No
Initiate Wide Negotiation	Yes

---

\* Some settings are valid only if the host adapter BIOS is enabled.

### **When to Use the SCSISelect™ Utility**

Use the SCSI Select utility if you need to do any one of the following:

- Change any of the default values listed in the SCSI Controller and All Devices Table.
- Check and/or change SCSI device settings that may conflict with those of other devices.
- Perform low-level formatting on new SCSI disk devices.

## 4.1 Running the SCSISelect™ Utility

A screen message giving the option to access the SCSISelect™ utility appears after the BIOS and POST routine.

To start the utility, press **CTRL** + A when the following message appears during power-on or system reset:

Press <Ctrl> <A> for SCSISelect™ Utility!



Your screen may show the key sequence as **CTRL** + <Hot Key> instead of **CTRL** + A. The correct sequence is **CTRL** + A.

## 4.2 Utility Options

When the SCSI Select utility detects that the AIC-7899W SCSI controller is in the system, it displays the following Options menu:

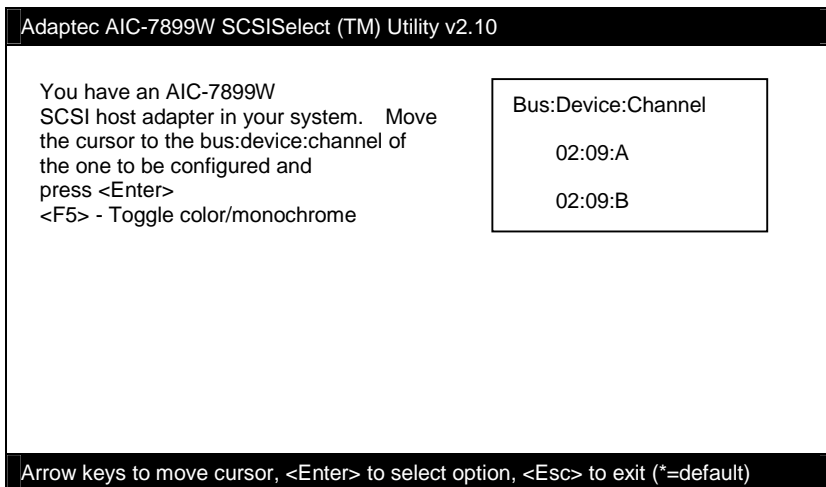



## 4.2.1 Configuring Channel A

The following screens appear if you select Channel A:





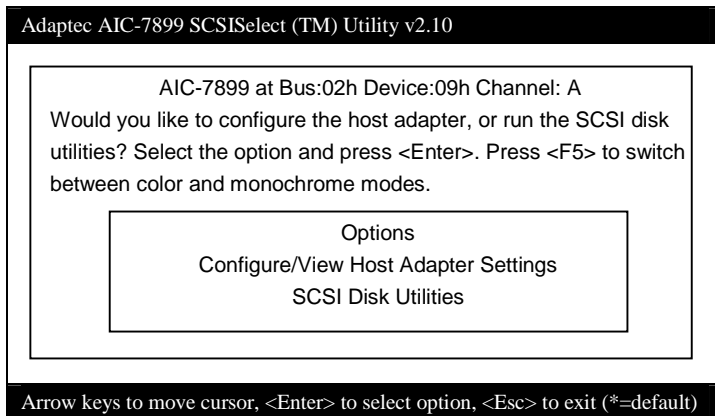

*If you choose to configure Channel B, a similar SCSI Utility Screen will appear. The only difference is the I/O Port Address:*

*A000h for Channel A*

*A400h for Channel B*



Using  and  and then press  to make selections in the SCSISelect™ utility. Press  at any time to return to the previous menu.



You can press  to toggle the display between color and monochrome modes.

*This feature may not work with some kinds of monitors.*

## 4.3 Configure/View Host Adapter Settings Menu

The Configure/View Host Adapter Settings menu lists three settings under SCSI Bus Interface Definitions and three additional options.

Adaptec AIC-7899 SCSISelect (TM) Utility v2.10

AIC-7896 at Bus:02h Device:09h Channel:A

Configuration

SCSI Bus Interface Definitions

Host Adapter SCSI ID .....7

SCSI Parity Checking .....Enabled

Host Adapter SCSI Termination.....Enabled

Additional Options

Boot Device Options.....Press <Enter>

SCSI Device Configuration.....Press <Enter>



Advanced Configuration Options.....Press <Enter>

BIOS Information

Interrupt (IRQ) Channel.....11

I/O Port Address.....A000h

Arrow keys to move cursor, <Enter> to select option, <Esc> to exit (\*=default)

Using  and  to select a parameter. Press  to display a pop-up menu with a list of possible settings for the parameter. Press  at any time to return to the previous menu.



*SCSI controller default settings are marked with an asterisk (\*) throughout the selection submenus.*

### 4.3.1 Host Adapter SCSI ID

This parameter allows you to change the host controller SCSI ID. The following screen shows the available IDs used for the AIC-7899. The default setting is SCSI ID 7, which has the highest priority on the SCSI bus. We recommend that you keep the default setting since most system applications run only in this setting.

Adaptec AIC-7899 SCSISelect (TM) Utility v2.10





AIC-7899 at Bus:02h Device:09h Channel:A

Configuration		
SCSI Bus Interface Definitions	0	
Host Adapter SCSI ID .....	1	.....7
SCSI Parity Checking .....	2	.....Enabled
Host Adapter SCSI Termination .....	3	.....Enabled
Additional Options	4	
Boot Device Options.....	5	
	6	
	*7	.....Press <Enter>
	8	
BIOS Info		
Interrupt (IRQ) Channel.....	9	
	10	.....11
	11	

Arrow keys to move cursor, <Enter> to select option, <Esc> to exit (\*=default)

Each device on the SCSI bus, including the SCSI controller, must be set to a unique SCSI ID. The SCSI ID serves two purposes. It uniquely identifies each SCSI device on the bus, and it determines

the device's priority on the bus during the arbitration phase. The arbitration phase determines which device controls the bus when two or more devices request for the use of it.





Using  and  then press  to select the SCSI ID if you need to change it. Press  at any time to return to the previous menu.

### 4.3.2 SCSI Parity Checking

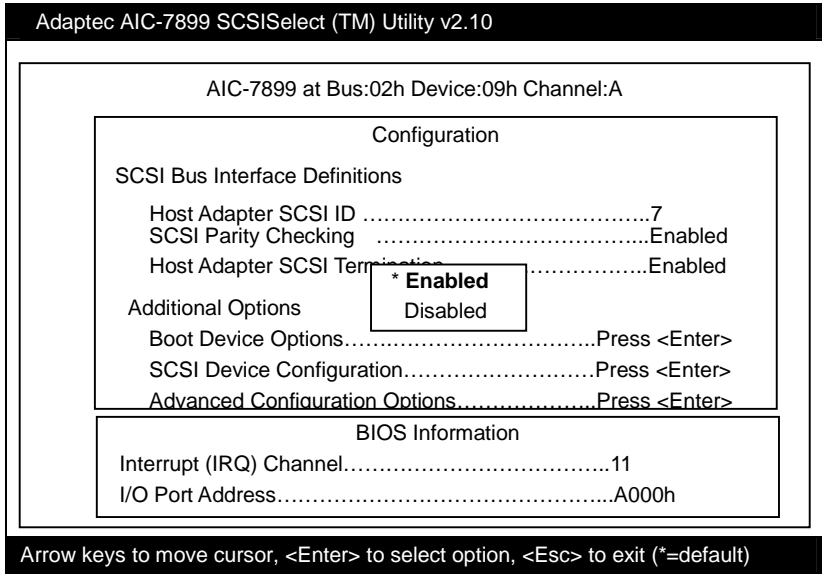
Select this option to enable or disable the SCSI parity checking function on the SCSI controller. The screen below displays the selections. The default setting is **“Enabled”**.

The SCSI controller always checks parity when reading from the SCSI bus to verify the correct transmission of data from the SCSI devices. You should disable the SCSI Parity Checking parameter if any of the installed SCSI devices do not support SCSI parity. Most currently available SCSI devices support this feature.



Using  and  then press  to select options. Press  at any time to return to the previous menu.

### 4.3.3 Boot Device Options

This parameter shows the target ID of your boot device. The default setting is 0 (zero). We recommend that you keep the default setting since most system applications run only in this setting. Below is the Boot Device Configuration menu screen.

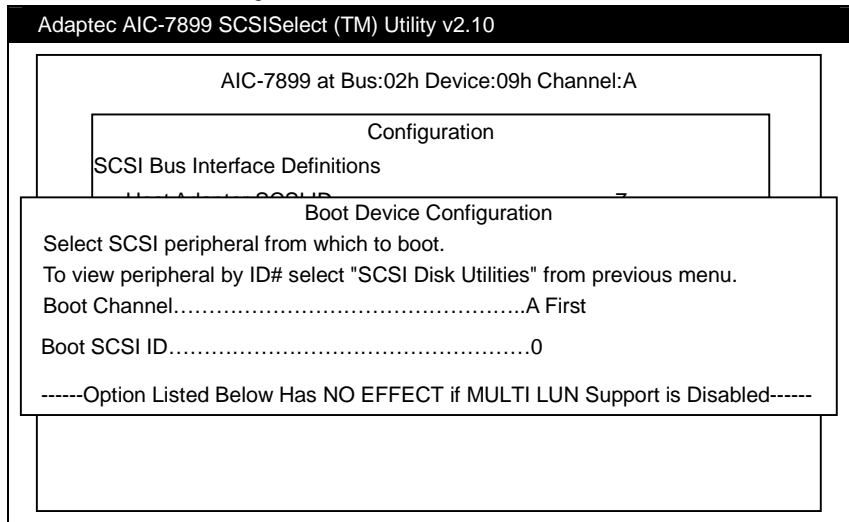



### 4.3.4 Boot Channel Options

This parameter lets you choosing boot the system from SCSI channel A or B first. The default setting is A (zero). We recommend that you keep the default setting since most system applications run only in this setting. Below is the Boot Device Configuration menu screen.

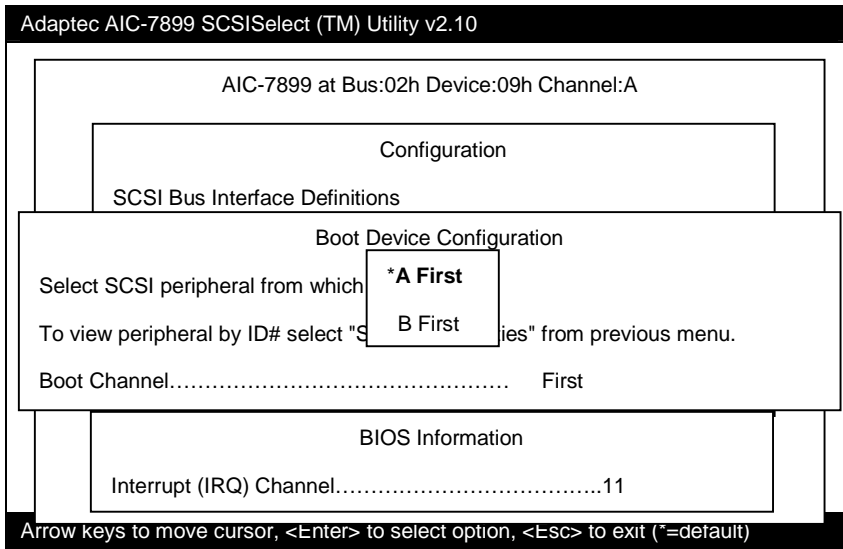

### 4.3.5 Boot SCSI ID Options

This parameter lets you choosing the SCSI ID of SCSI device to be a boot device. The default setting is 0 (zero). We recommend that you keep the default setting since most system applications run only in this setting. Below is the Boot Device Configuration menu screen.

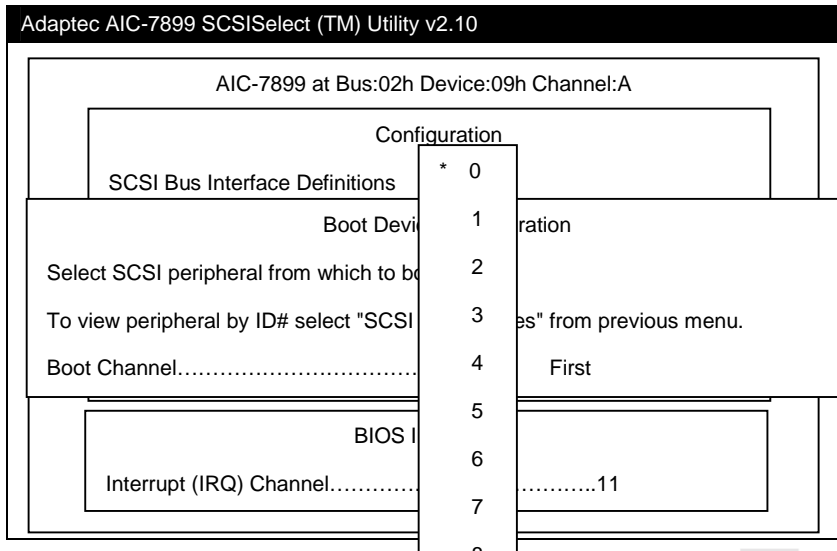

### 4.3.6 Boot LUN Number Options

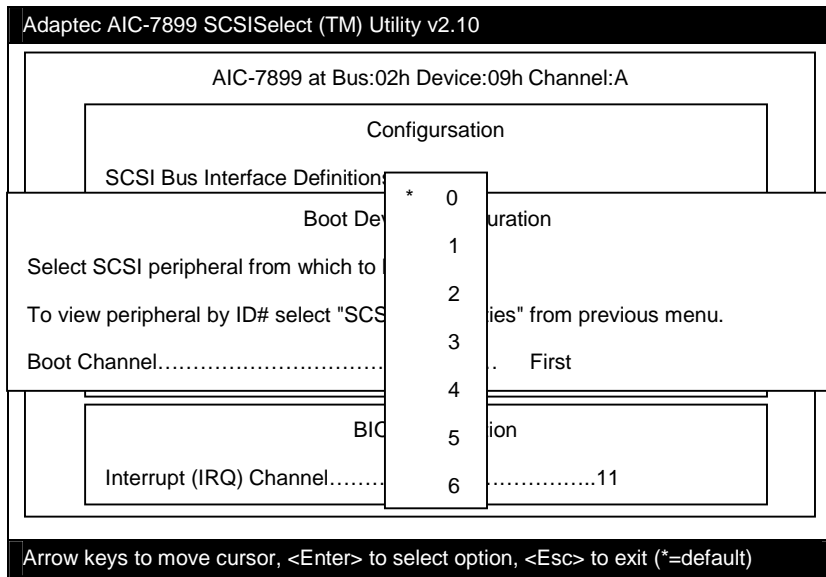

### **4.3.7 Boot LUN Number**

LUN (Logic unit number) can support more devices, like RAID box or RAID card.



#### **4.3.7.1 SCSI Device Configuration**



This parameter allows you to configure details of each SCSI device on the SCSI bus. The screen shows a column of information for each SCSI ID, even if some SCSI IDs are not assigned to a device. To configure a specific SCSI device, you need to know which SCSI ID it uses. See the SCSI Disk Utilities later in this section for instructions on how to determine the SCSI ID used by a device.

## Adaptec AIC-7899 SCSISelect (TM) Utility v2.10

SCSI Device ID	SCSI Device Configuration							
	#0	#1	#2	#3	#4	#5	#6	#7
Sync Transfer Rate (MB/Sec).	160.0	160.0	160.0	160.0	160.0	160.0	160.0	160.0
Initiate Wide Negotiation.....	Yes	Yes	Yes	Yes	Yes	Yes	Yes	Yes
Enable Disconnection.....	Yes	Yes	Yes	Yes	Yes	Yes	Yes	Yes
Send Start Unit Command.....	Yes	Yes	Yes	Yes	Yes	Yes	Yes	Yes
Enable Write Back Cache.....	N/C	N/C	N/C	N/C	N/C	N/C	N/C	N/C
-----Options Listed Below Have NO EFFECT if the BIOS is Disabled-----								
BIOS Multiple LUN Support.....	No	No	No	No	No	No	No	No
Include in BIOS Scan.....	Yes	Yes	Yes	Yes	Yes	Yes	Yes	Yes
SCSI Device ID	#8	#9	#10	#11	#12	#13	#14	#15
Sync Transfer Rate (MB/Sec).....	80.0	80.0	80.0	80.0	80.0	80.0	80.0	80.0
Initiate Wide Negotiation.....	Yes	Yes	Yes	Yes	Yes	Yes	Yes	Yes
Enable Disconnection.....	Yes	Yes	Yes	Yes	Yes	Yes	Yes	Yes
Send Start Unit Command.....	Yes	Yes	Yes	Yes	Yes	Yes	Yes	Yes
Enable Write Back Cache.....	N/C	N/C	N/C	N/C	N/C	N/C	N/C	N/C
-----Options Listed Below Have NO EFFECT if the BIOS is Disabled-----								
BIOS Multiple LUN Support.....	No	No	No	No	No	No	No	No
Include in BIOS Scan.....	Yes	Yes	Yes	Yes	Yes	Yes	Yes	Yes

Arrow keys to move cursor, <Enter> to select option, <Esc> to exit (\*=default)

Using  or  to move between options, then press  to display a pop-up menu with a list of values.

Using  or  to select a value, then press .

#### 4.3.7.2 Sync Transfer Rate

This option determines the maximum synchronous data transfer rate that the SCSI controller can support. The SCSI controller supports rates up to the Fast Wide SCSI maximum of 80.0 MB per second. The default value is 80.0.

In most cases, you can use the maximum value of 80.0. However, if the SCSI controller is not set to negotiate data transfer (i.e., Initiate Sync Negotiation is set to No), the value selected here is the maximum rate that the SCSI controller accepts from the device during negotiation. This is a standard SCSI protocol.



*Some older SCSI-1 devices do not support Fast SCSI data transfer rates. This may cause the system to operate erratically or hang if the transfer rate is too high.*

#### 4.3.7.3 Initiate Wide Negotiation

This option allows communication between all devices (lower 8-bit or upper 8-bit) on the wide (16-bit) SCSI bus. When set to **Yes**, each device can connect on the bus. When set to **No** (disabled), communication can only occur on the lower eight bits of the 16-bit SCSI bus. The default setting is **Yes**.

#### 4.3.7.4 Enable Disconnection

This option determines whether the SCSI controller allows a SCSI device to disconnect from the SCSI bus (sometimes called Disconnect/Reconnect). Disconnect/Reconnect allows the SCSI controller to perform other operations on the SCSI bus while the SCSI device is temporarily disconnected.

When set to **Yes**, the SCSI device may disconnect from the SCSI bus. The SCSI device, however, may choose not to disconnect, even if permitted by the SCSI controller. When set to **No**, the SCSI device is not allowed to disconnect from the SCSI bus. The default setting is **Yes**.

Keep this item set to **Yes** if two or more SCSI devices are connected to the SCSI controller. This can optimize SCSI bus performance. If only one SCSI device is connected to the SCSI controller, set this item to No to achieve better system performance.

#### 4.3.7.5 Send Start Unit Command

This option determines whether the Start Unit Command (SCSI command 1B) is sent to the SCSI device (most devices do not require this). Enabling this item reduces the load on the system power supply by allowing the SCSI controller to power up SCSI devices one at a time upon booting. Otherwise, all the devices power up at the same time. Most devices require you to set a jumper before they can respond to this command.

When set to **Yes**, the Start Unit Command is sent to the SCSI device at system boot. When set to **No**, each SCSI device powers up in the normal procedure.



*The Send Start Unit Command setting is valid only if the host adapter BIOS is enabled.*

If this option is enabled for more than one SCSI device, the Start Unit Command is sent first to the device with the lowest SCSI ID. When this device responds to the SCSI controller, the Start Unit Command is sent to the next highest SCSI ID with a setting of Yes. The process continues until all supported devices respond to the SCSI controller.



If many drives are set to **Yes** for Send Start Unit Command, the boot time varies depending on how long it takes each drive to spin up.



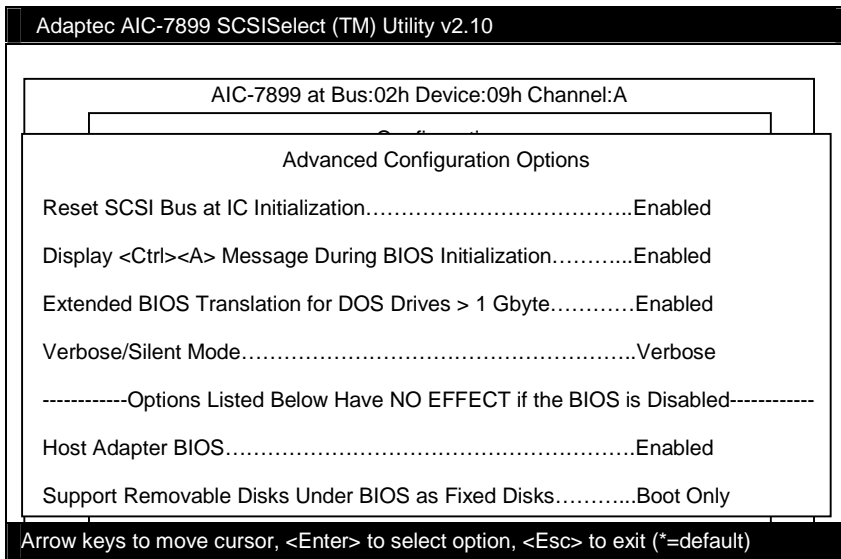

## 4.4 Advanced Configuration Options

Selecting the Advanced Configuration Options displays a screen as shown below. Do not change the settings of the items under this parameter unless it is absolutely necessary.



Using  or to move between options, then press  to display a pop-up menu with a list of options.

Using  or  to select an option, then press .

#### 4.4.1 Host Adapter BIOS

This option enables or disables the SCSI controller BIOS. The default setting is **Enabled**.

The SCSI controller BIOS must be enabled if you want the system to boot from a SCSI hard disk drive connected to the SCSI controller. Several SCSISelect™ options cannot be used unless the SCSI controller BIOS is enabled.

#### 4.4.2 Display <Ctrl-A> Message During BIOS Initialization

This option allows entering the SCSISelect™ utility during BIOS initialization. The default setting is **Enabled**.

#### 4.4.3 Extended BIOS Translation for DOS Drives > 1 GByte

This option allows you to enable or disable extended translation for SCSI hard disks with a capacity greater than 1 GB. This is valid only if the SCSI controller BIOS is enabled. The default factory

setting is **Enabled**.

When enabled, this option uses the following translation schemes:

- **SCSI hard disks < 1 GB** use a translation scheme of 64 heads, 32 sectors per track
- **SCSI hard disks > 1 GB** use a translation scheme of 255 heads, 63 sectors per track



*See the section "Disk Drives Over 1 GB" in this chapter, for more information on this option. This option should be left disabled for most operating systems except DOS.*

#### 4.4.4 Support Removable Disks Under BIOS as Fixed Disks

This option allows you to control which removable-media drives are supported by the SCSI controller BIOS. This is only valid when the SCSI controller BIOS is enabled. The default setting is **Boot Only**. The following choices are available:

- **Boot Only** - Only the removable-media drive designated as the boot device is treated as a hard disk drive.

- **All Disks** - All removable-media drives supported by the BIOS are treated as hard disk drives.
- **Disabled** - No removable-media drives are treated as hard disk drives. In this case, software drivers are needed because the drives are not controlled by BIOS.

Support for removable-media drives means that the SCSI controller BIOS allows use of a removable-media drive as if it is a hard disk drive. It does not mean that you can remove the disk media during operation.



*If a removable-media SCSI device is controlled by the SCSI controller BIOS, do not remove the media while the drive is powered-on or you may lose data!*

#### 4.4.5 BIOS Support for Bootable CD-ROM

When enabled, this option allows you to use a bootable CD-ROM device to directly load an operating system. The default setting is **Enabled**.

#### 4.4.6 BIOS Support for Int13 Extensions

This option allows access to attached SCSI devices through BIOS Int13 functions. The default setting is **Enabled**.

## 4.5 SCSI Disk Utilities

When you select SCSI Disk Utilities from the Options menu, the SCSISelect™ Utility scans the SCSI bus and lists all SCSI devices installed on the SCSI bus. The list shows the individual SCSI IDs assigned to each device on the SCSI bus.

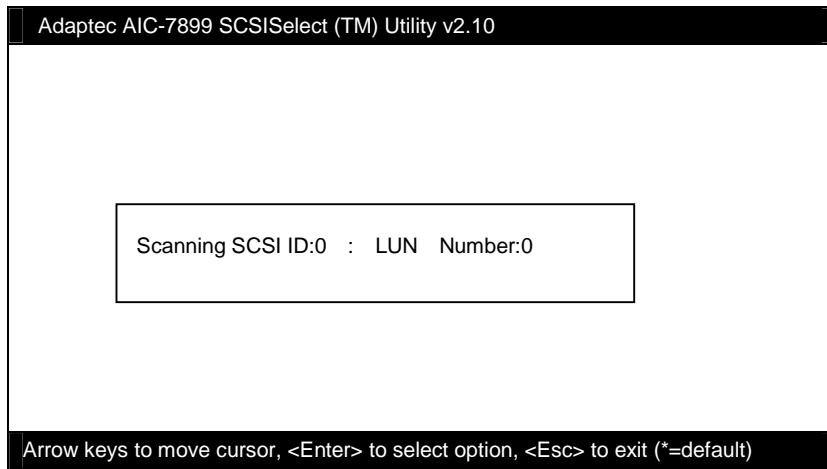

## Adaptec AIC-7899 SCSISelect (TM) Utility v2.10

AIC-7899 at Bus:02h Device:09h Channel:A

Select SCSI Disk and press &lt;Enter&gt;

SCSI ID #0: No device

SCSI ID #1: No device

SCSI ID #2: No device

SCSI ID #3: No device



SCSI ID #4: No device



SCSI ID #5: No device

SCSI ID #6: No device

Arrow keys to move cursor, &lt;Enter&gt; to select option, &lt;Esc&gt; to exit (\*=default)

Select a disk device to display a small menu window. From this menu, select **Format Disk** or **Verify Media**.

Using  or  to move between options, then press  to display a pop-up menu with a list of values.

Using  or  to select a value, then press .

### 4.5.1 Format Disk

The Format Disk utility performs a low-level format on disk devices.

Most SCSI disk devices are preformatted and do not need to be formatted again. The Adaptec Format Disk utility is compatible with the vast majority of SCSI disk drives. Run it on hard disk drives or removable-media drives that were previously used with a non-Adaptec SCSI controller.



*A low-level format destroys all data on the drive. Be sure to back up your data before performing this operation. You cannot abort a low-level format once it is started.*



## 4.5.2 Verify Media

The Verify Media utility scans the selected device's media for defects. If the utility finds bad blocks, it prompts you to reassign them. If you select **Yes**, those blocks will no longer be used.



You can press  at any time to abort the Verify Disk Media utility.

## **4.6 Disk Drives Over 1 GByte**

### **4.6.1 Extended Translation**

Adaptec SCSI controllers have always supported the full range of disk drive capacities under all major operating systems. As disk drives have recently grown beyond 1 GB in formatted capacity, they have run up against the DOS 1024-cylinder limit.

To continue its support for all SCSI disk drive capacities under DOS, Adaptec has included an extended translation scheme for the AIC-7896 SCSI controllers. This feature supports disk drives of up to 8 GB capacity under DOS. The section Extended BIOS Translation for DOS Drives > 1 GB explains how to change the setting of this option. Most operating systems leave this option disabled.

### **4.6.2 DOS 1 GByte Limit**

All current versions of DOS are limited to 1024 cylinders per drive. The standard translation scheme for SCSI host controllers, using 64 heads and 32 sectors, gives a maximum capacity of 1 GB.

To eliminate the 1-GB limit, Adaptec's extended translation feature uses 255 heads and 63 sectors, extending the disk drive capacity limit under DOS to 8 GB.



*If you have already partitioned a large hard disk drive with one translation method, conversion to another method erases the data on the drive. Be sure to back up your disk drive prior to any change in the translation method.*

## **4.7 When to Use the Extended Translation**

### **4.7.1 with DOS 5.0 and above**

NetWare 386 (version 3.0 and above) and some versions of UNIX that do not share the 1024 cylinder limit of DOS do not require extended translation to support large disk drives and should not be enabled.

### **4.7.2 drives with mixed partitions**

Use standard translation (not extended translation) on drives formatted with two or more partitions for different operating systems. Partitions for UNIX and NetWare can be larger than 1 GB when using standard translation.

### **4.7.3 Using FDISK**

To install a new disk, or to re-partition an existing disk, use the FDISK DOS utility as you normally would. The cylinder size increases to 8 MB when you enable extended translation. The size of the partition you request must therefore be a multiple of 8 MB. If you request a partition size that is not a multiple of 8 MB, FDISK rounds up to the nearest whole multiple of 8 MB.

## Glossary

### **AC97**

Basically, AC97 specification separates sound/modem circuit to two parts, digital processor and a [CODEC](#) for analog I/O they are linked by AC97 link bus. Since digital processor can be put into motherboard main chipset, the cost of sound/modem onboard solution can be reduced.

### **ACPI (Advanced Configuration & Power Interface)**

ACPI is the power management specification of PC97 (1997). It intends to save more power by taking full control of power management to operating system and bypass [BIOS](#). The chipset or super I/O chip needs to provide standard register interface to operating system (such as Windows 98). This is a bit similar as the [PnP](#) register interface. ACPI defines ATX momentary soft power switch to control the power state transition.

## **AGP (Accelerated Graphic Port)**

AGP is a bus interface targeted for high-performance 3D graphic. AGP supports only memory read/write operation and single-master single-slave one-to-one only. AGP uses both rising and falling edge of the 66MHz clock, for 2X AGP, the data transfer rate is  $66\text{MHz} \times 4\text{byte} \times 2 = 528\text{MB/s}$ . AGP is now moving to 4X mode,  $66\text{MHz} \times 4\text{byte} \times 4 = 1056\text{MB/s}$ . AOpen is the first company to support 4X AGP motherboards by both AX6C (Intel 820) and MX64/AX64 (VIA 694x), started from Oct 1999.

## **AMR (Audio/Modem Riser)**

The [CODEC](#) circuit of AC97 sound/modem solution can be put on motherboard or put on a riser card (AMR card) that connects to motherboard through AMR connector.

## **AOpen Bonus Pack CD**

A disc bundled with AOpen motherboard product, there are motherboard drivers, Acrobat Reader for [PDF](#) online manual and other useful utilities.

## **APM**

Unlike [ACPI](#), BIOS controls most APM power management functions. AOpen Suspend to Hard Drive is a good example of APM power management.

## **ATA/66**

ATA/66 uses both rising edge and falling edge but doubles [UDMA/33](#) transfer rate. The data transfer rate is 4 times of the PIO mode 4 or DMA mode 2, 16.6MB/s x4 = 66MB/s. To use ATA/66, you need special ATA/66 IDE cable.

## **ATA/100**

ATA/100 is a new IDE specification under developing. ATA/100 uses both rising edge and falling edge as [ATA/66](#) but clock cycle time is reduced to 40ns. The data transfer rate is (1/40ns) x 2 bytes x 2 = 100MB/s. To use ATA/100, you need special 80-wire IDE cable, the same as ATA/66.

## **BIOS (Basic Input/Output System)**

BIOS is a set of assembly routine/program that reside in [EPROM](#) or [Flash ROM](#). BIOS controls Input/output devices and other hardware devices of motherboard. In general, to provide hardware independent portability, operation system and drivers is required to access BIOS without directly access hardware devices.

## **Bus Master IDE (DMA mode)**

The traditional PIO (Programmable I/O) IDE requires the CPU to involve in all the activities of the IDE access including waiting for the mechanical events. To reduce the workload of the CPU, the bus master IDE device transfers data from/to memory without interrupting CPU, and releases CPU to operate concurrently while data is transferring between memory and IDE device. You need the bus master IDE driver and the bus master IDE HDD to support bus master IDE mode.

## **CODEC (Coding and Decoding)**

Normally, CODEC means a circuit that can do digital to analog conversion and also the analog to digital conversion. It is part of [AC97](#) sound/modem solution.



## ***DIMM (Dual In Line Memory Module)***

DIMM socket has total 168-pin and supports 64-bit data. It can be single or double side, the golden finger signals on each side of PCB are different, that is why it was called Dual In Line. Almost all DIMMs are made by [SDRAM](#), which operate at 3.3V. Note that some old DIMMs are made by FPM/[EDO](#) and only operate at 5V. Do not confuse them with SDRAM DIMM.

## ***ECC (Error Checking and Correction)***

The ECC mode needs 8 ECC bits for 64-bit data. Each time memory is accessed, ECC bits are updated and checked by a special algorithm. The ECC algorithm has the ability to detect double-bit error and automatically correct single-bit error while parity mode can only detect single-bit error.

## ***EDO (Extended Data Output) Memory***

The EDO DRAM technology is actually very similar to FPM (Fast Page Mode). Unlike traditional FPM that tri-states the memory output data to start the pre-charge activity, EDO DRAM holds the memory data valid until the next memory access cycle, that is similar to pipeline effect and reduces one clock state.

## ***EEPROM (Electronic Erasable Programmable ROM)***

Also known as E<sup>2</sup>PROM. Both EEPROM and [Flash ROM](#) can be re-programmed by electronic signals, but the interface technology is different. Size of EEPROM is much smaller than flash ROM, AOpen motherboard uses EEPROM for jumper-less and battery-less design.

## ***EPROM (Erasable Programmable ROM)***

Traditional motherboard stores BIOS code in EPROM. EPROM can only be erased by ultra-violet (UV) light. If BIOS has to be upgraded, you need to remove EPROM from motherboard, clear by UV light, re-program, and then insert back.

## ***EV6 Bus***

EV6 Bus in the technology of Alpha processor from Digital Equipment Corporation. EV6 bus uses both rising and falling clock edge to transfer data, similar as DDR SDRAM or ATA/66 IDE bus.

EV6 Bus Speed = CPU external bus clock x 2.

For example, 200 MHz EV6 bus is actually using 100 MHz external bus clock, but the equivalent speed is 200 MHz.

## ***FCC DoC (Declaration of Conformity)***

The DoC is component certification standard of FCC EMI regulations. This standard allows DIY component (such as motherboard) to apply DoC label separately without a shielding of housing.

## ***FC-PGA***

FC means Flip Chip, FC-PGA is a new package of Intel for Pentium III CPU. It can plug into SKT370 socket, but require motherboard to add some signals on socket 370. That is, the motherboard needs to be redesigned. Intel is going to ship FC-PGA 370 CPU and phase out slot1 CPU.

## ***Flash ROM***

Flash ROM can be re-programmed by electronic signals. It is easier for BIOS to upgrade by a flash utility, but it is also easier to be infected by virus. Because of increase of new functions, BIOS size is increased from 64KB to 256KB (2M bit). AOpen AX5T is the first board to implement 256KB (2Mbit) Flash ROM. Now flash ROM size is moving to 4M bit on AX6C (Intel 820) and MX3W (Intel 810) motherboard.

## **FSB (Front Side Bus) Clock**

FSB Clock means CPU external bus clock.

CPU internal clock = CPU FSB Clock x CPU Clock Ratio

## **I<sup>2</sup>C Bus**

See [SMBus](#).

## **P1394**

P1394 (IEEE 1394) is a standard of high-speed serial peripheral bus. Unlike low or medium speed [USB](#), P1394 supports 50 to 1000Mbit/s and can be used for video camera, disk and LAN.

## **Parity Bit**

The parity mode uses 1 parity bit for each byte, normally it is even parity mode, that is, each time the memory data is updated, parity bit will be adjusted to have even count "1" for each byte. When next time, if memory is read with odd number of "1", the parity error is occurred and this is called single bit error detection.

### ***PBSRAM (Pipelined Burst SRAM)***

For Socket 7 CPU, one burst data read requires four QWord (Quad-word, 4x16 = 64 bits). PBSRAM only needs one address decoding time and automatically sends the remaining QWords to CPU according to a predefined sequence. Normally, it is 3-1-1-1, total 6 clocks, which is faster than asynchronous SRAM. PBSRAM is often used on L2 (level 2) cache of Socket 7 CPU. Slot 1 and Socket 370 CPU do not need PBSRAM.

### ***PC100 DIMM***

[SDRAM](#) DIMM that supports 100MHz CPU [FSB](#) bus clock.

### ***PC133 DIMM***

[SDRAM](#) DIMM that supports 133MHz CPU [FSB](#) bus clock.

## **PDF Format**

A file format for electronic document, PDF format is independent from platform, you can read PDF file under Windows, Unix, Linux, Mac ... with different PDF reader. You can also read PDF file by web browser such as IE and Netscape, note that you need to install PDF plug-in first (Included in Acrobat Reader).

## **PnP (Plug and Play)**

The PnP specification suggests a standard register interface for both BIOS and operating system (such as Windows 95). These registers are used by BIOS and operating system to configure system resource and prevent any conflicts. The IRQ/DMA/Memory will be automatically allocated by PnP BIOS or operating system. Currently, almost all the PCI cards and most ISA cards are already PnP compliant.

## **POST (Power-On Self Test)**

The BIOS self test procedure after power-on, sometimes, it is the first or the second screen shown on your monitor during system boot.

## **RDRAM (Rambus DRAM)**

Rambus is a memory technology that uses large burst mode data transfer. Theoretically, the data transfer should be high than [SDRAM](#). RDRAM is cascaded in channel operation. For Intel 820, only one RDRAM channel is supported, 16-bit data per channel, and this channel may have maximum 32 RDRAM devices, no matter how many [RIMM](#) sockets.

## **RIMM**

184-pin memory module that supports [RDRAM](#) memory technology. A RIMM memory module may contain up to maximum of 16 RDRAM devices.

## **SDRAM (Synchronous DRAM)**

SDRAM is one of the DRAM technologies that allows DRAM to use the same clock as the CPU host bus ([EDO](#) and [FPM](#) are asynchronous and do not have clock signal). It is similar as [PBSRAM](#) to use burst mode transfer. SDRAM comes in 64-bit 168-pin [DIMM](#) and operates at 3.3V. AOpen is the first company to support dual-SDRAM DIMMs onboard (AP5V), from Q1 1996

## ***SIMM (Single In Line Memory Module)***

SIMM socket is only 72-pin, and is only single side. The golden finger signals on each side of PCB are identical. That is why it was called Single In Line. SIMM is made by FPM or [EDO](#) DRAM and supports 32-bit data. SIMM had been phased out on current motherboard design.

## ***SMBus (System Management Bus)***

SMBus is also called I2C bus. It is a two-wire bus developed for component communication (especially for semiconductor IC). For example, set clock of clock generator for jumper-less motherboard. The data transfer rate of SMBus is only 100Kbit/s, it allows one host to communicate with CPU and many masters and slaves to send/receive message.

## ***SPD (Serial Presence Detect)***

SPD is a small ROM or [EEPROM](#) device resided on the [DIMM](#) or [RIMM](#). SPD stores memory module information such as DRAM timing and chip parameters. SPD can be used by [BIOS](#) to decide best timing for this DIMM or RIMM.



### **Ultra DMA/33**

Unlike traditional PIO/DMA mode, which only uses the rising edge of IDE command signal to transfer data. UDMA/33 uses both rising edge and falling edge, the data transfer rate is double of the PIO mode 4 or DMA mode 2.

16.6MB/s x2 = 33MB/s

### **USB (Universal Serial Bus)**

USB is a 4-pin serial peripheral bus that is capable of cascading low/medium speed peripherals (less than 10Mbit/s) such as keyboard, mouse, joystick, scanner, printer and modem. With USB, the traditional complex cables from back panel of your PC can be eliminated.

### **VCM (Virtual Channel Memory)**

NEC's Virtual Channel Memory (VCM) is a new DRAM core architecture that dramatically improves the memory system's ability to service multimedia requirements. VCM increases memory bus efficiency and performance of any DRAM technology by providing a set of fast static registers between the memory core and I/O pins. Using VCM technology results in reduced data access latency and reduced power consumption.

**ZIP file**

A compressed file format to reduce file size. To unzip file, run shareware PKUNZIP (<http://www.pkware.com/>) for DOS and other operating system or WINZIP (<http://www.winzip.com/>) for windows environment.



# Troubleshooting

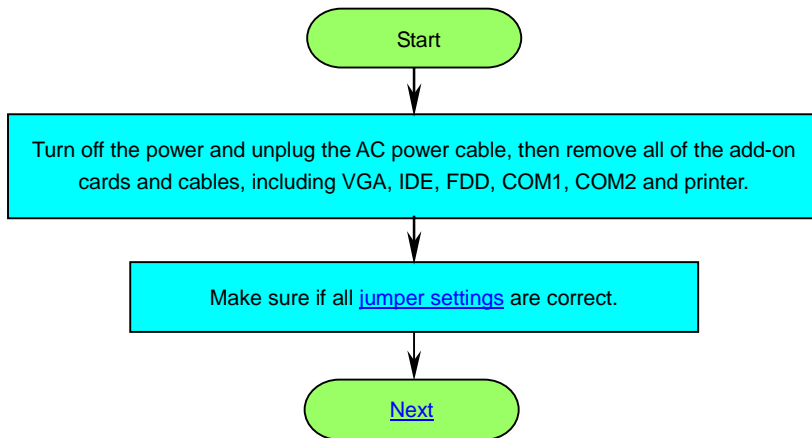

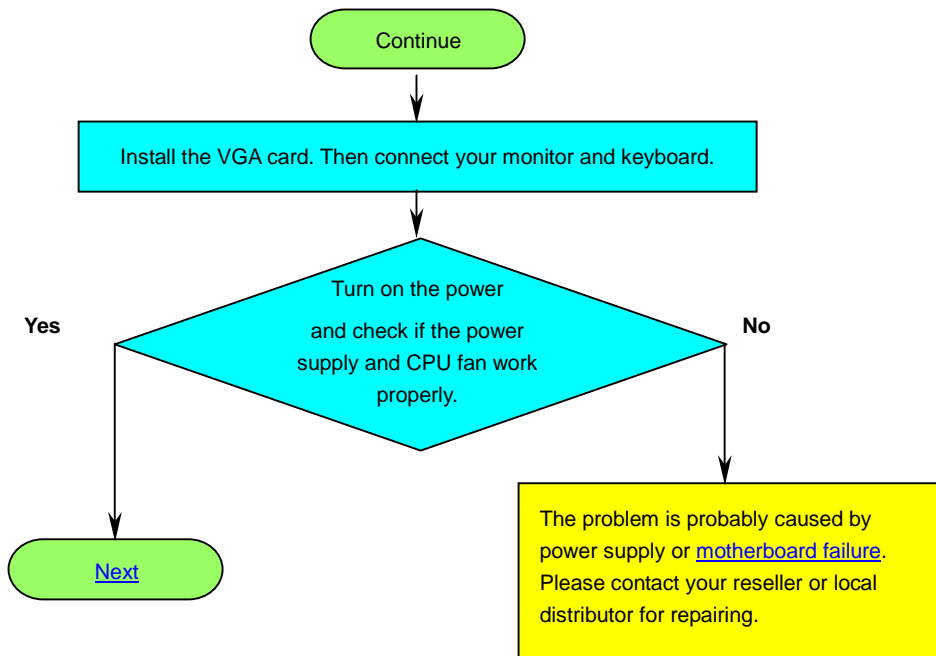

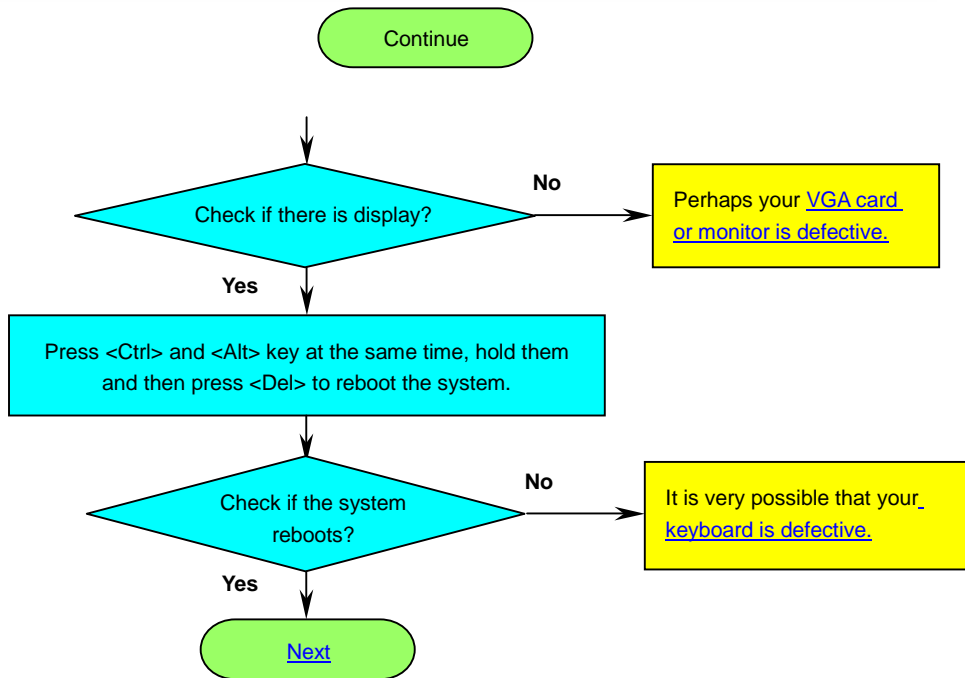

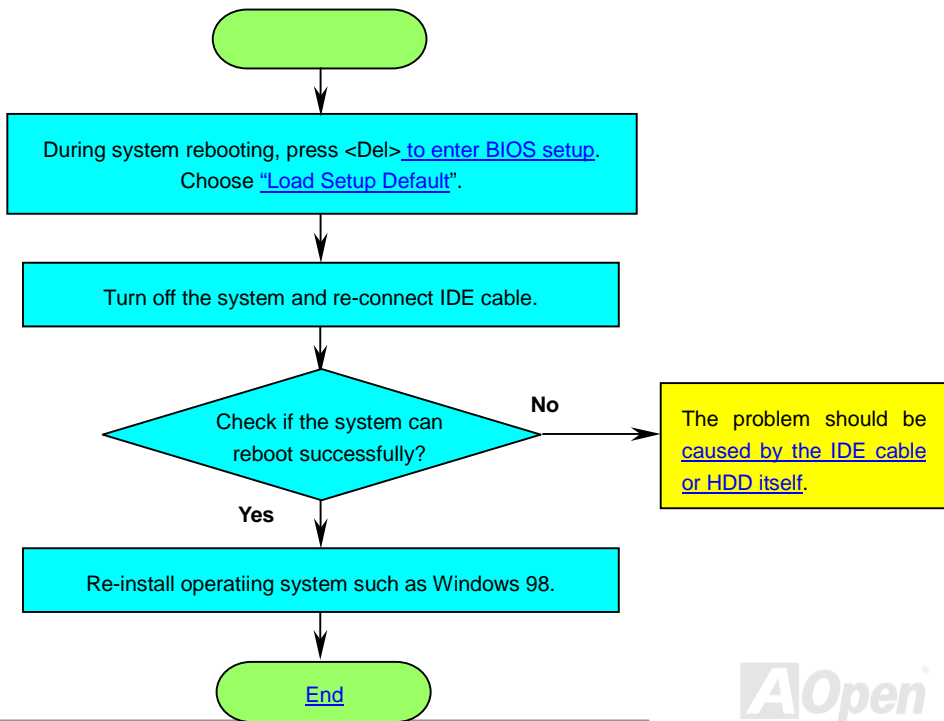



## Technical Support

Dear Customer,

Thanks for choosing AOpen products. To provide the best and fastest service to our customer is our first priority. However, we receive numerous emails and phone-calls worldwide everyday, it is very hard for us to serve everyone on time. We recommend you follow the procedures below and seek help before contact us. With your help, we can then continue to provide the best quality service to more customers.

Thanks very much for your understanding!

AOpen Technical Supporting Team

1

**Online Manual:** Please check the manual carefully and make sure the jumper settings and installation procedure are correct.

<http://www.aopen.com.tw/tech/download/manual/default.htm>

2

**Test Report:** We recommend to choose board/card/device from the compatibility test reports for assembling your PC.

<http://www.aopen.com.tw/tech/report/default.htm>

3

**FAQ:** The latest FAQ (Frequently Asked Questions) may contain a solution to your problem.

<http://www.aopen.com.tw/tech/faq/default.htm>

4

**Download Software:** Check out this table to get the latest updated BIOS/utility and drivers.

<http://www.aopen.com.tw/tech/download/default.htm>

5

**News Group:** Your problem probably had been answered by our support engineer or professional users on the news group.

<http://www.aopen.com.tw/tech/newsgrp/default.htm>

6

**Contact Distributors/Resellers:** We sell our products through resellers and integrators. They should know your system configuration very well and should be able to solve your problem more efficiently than us. After all, their attitude of service is an important reference for you if next time you want to buy something else from them.



**7**

**Contact Us:** Please prepare detail system configuration and error symptom before contacting us. The **part number**, **serial number** and **BIOS version** are also very helpful.

### **Part Number and Serial Number**

The Part Number and Serial number are printed on bar code label. You can find this bar code label on the outside packing, on ISA/CPU slot or on component side of PCB. For example:



**P/N: 91.88110.201** is part number, **S/N: 91949378KN73** is serial number.

## Product Registration



Thank you for choosing AOpen product. AOpen encourages you to spend few minutes in completing the following product registration. To register your product will ensure the high quality of services from AOpen. After the registration, you will:

- Have opportunities to play online slot machine and win a prize from AOpen by accumulating your bonuses for later prize exchange.
- Be upgraded to gold membership of Club AOpen program.
- Receive email notification about product safety alerts. Its purpose is to alert consumers quickly and conveniently when products contain technical issues.
- Receive email notification about latest product's announcements.
- Be able to personalize your AOpen web pages.
- Receive e-mail notification about latest BIOS/Driver/Software release information.
- Have opportunities to participate special product promotional programs.
- Enjoy higher service priority to receive technical assistance provided by AOpen specialists worldwide.
- Be able to join the discussions of web-based news groups.

AOpen makes sure that the information you provide is encrypted, so that it cannot be read or intercepted by other people or companies. Further, AOpen will not disclose any of information you submitted under any conditions. Please consult our [online privacy policy](#) for further information on our company policy.





## How to Contact Us



Please do not hesitate contact us if you have any problem about our products. Any opinion will be appreciated.

Pacific Rim  
AOpen Inc.  
Tel: 886-2-2696-1333  
Fax: 886-2-8691-2233

Europe  
AOpen Computer b.v.  
Tel: 31-73-645-9516  
Fax: 31-73-645-9604

America  
AOpen America Inc.  
Tel: 1-510-498-8928  
Fax: 1-408-922-2935,  
1-408-432-0496

China  
艾爾鵬國際上海(股)有限公司  
Tel: 49-2102-157700  
Fax: 49-2102-157799

Germany  
AOpen Computer  
GmbH.  
Tel: 49-2102-157700  
Fax: 49-2102-157799

Web Site: <http://www.aopen.com.tw>

E-mail: Send us email by going through the contact form below.

English <http://www.aopen.com.tw/tech/contact/techusa.htm>

Japanese <http://aojp.aopen.com.tw/tech/contact/techjp.htm>

Chinese <http://w3.aopen.com.tw/tech/contact/techtw.htm>

German <http://www.aopencom.de/tech/contact/techde.htm>

French <http://aofr.aopen.com.tw/tech/contact/techfr.htm>

Simplified Chinese <http://www.aopen.com.cn/tech/contact/techcn.htm>