

**ASUS<sup>®</sup> MEW-L**

Socket 370 Intel<sup>®</sup> 810 Motherboard

**USER'S MANUAL**

# USER'S NOTICE

---

No part of this manual, including the products and software described in it, may be reproduced, transmitted, transcribed, stored in a retrieval system, or translated into any language in any form or by any means, except documentation kept by the purchaser for backup purposes, without the express written permission of ASUSTeK COMPUTER INC. ("ASUS").

ASUS PROVIDES THIS MANUAL "AS IS" WITHOUT WARRANTY OF ANY KIND, EITHER EXPRESS OR IMPLIED, INCLUDING BUT NOT LIMITED TO THE IMPLIED WARRANTIES OR CONDITIONS OF MERCHANTABILITY OR FITNESS FOR A PARTICULAR PURPOSE. IN NO EVENT SHALL ASUS, ITS DIRECTORS, OFFICERS, EMPLOYEES OR AGENTS BE LIABLE FOR ANY INDIRECT, SPECIAL, INCIDENTAL, OR CONSEQUENTIAL DAMAGES (INCLUDING DAMAGES FOR LOSS OF PROFITS, LOSS OF BUSINESS, LOSS OF USE OR DATA, INTERRUPTION OF BUSINESS AND THE LIKE), EVEN IF ASUS HAS BEEN ADVISED OF THE POSSIBILITY OF SUCH DAMAGES ARISING FROM ANY DEFECT OR ERROR IN THIS MANUAL OR PRODUCT.

Product warranty or service will not be extended if: (1) the product is repaired, modified or altered, unless such repair, modification or alteration is authorized in writing by ASUS; or (2) the serial number of the product is defaced or missing.

Products and corporate names appearing in this manual may or may not be registered trademarks or copyrights of their respective companies, and are used only for identification or explanation and to the owners' benefit, without intent to infringe.

- QuickStart and JumperFree are trademarks of ASUSTeK Computer Inc.
- Intel, LANDesk, and Pentium are registered trademarks of Intel Corporation.
- IBM and OS/2 are registered trademarks of International Business Machines.
- XGstudio and SoftSynthesizer are registered trademarks of Yamaha Corporation.
- Symbios is a registered trademark of Symbios Logic Corporation.
- Windows and MS-DOS are registered trademarks of Microsoft Corporation.
- Adobe and Acrobat are registered trademarks of Adobe Systems Incorporated.

The product name and revision number are both printed on the product itself. Manual revisions are released for each product design represented by the digit before and after the period of the manual revision number. Manual updates are represented by the third digit in the manual revision number.

For previous or updated manuals, BIOS, drivers, or product release information, contact ASUS at <http://www.asus.com.tw> or through any of the means indicated on the following page.

SPECIFICATIONS AND INFORMATION CONTAINED IN THIS MANUAL ARE FURNISHED FOR INFORMATIONAL USE ONLY, AND ARE SUBJECT TO CHANGE AT ANY TIME WITHOUT NOTICE, AND SHOULD NOT BE CONSTRUED AS A COMMITMENT BY ASUS. ASUS ASSUMES NO RESPONSIBILITY OR LIABILITY FOR ANY ERRORS OR INACCURACIES THAT MAY APPEAR IN THIS MANUAL, INCLUDING THE PRODUCTS AND SOFTWARE DESCRIBED IN IT.

**Copyright © 1999 ASUSTeK COMPUTER INC. All Rights Reserved.**

Product Name:	<b>ASUS MEW-L</b>
Manual Revision:	<b>1.08 E459</b>
Release Date:	<b>October 1999</b>

# ASUS CONTACT INFORMATION

---

## ASUSTeK COMPUTER INC. (Asia-Pacific)

### *Marketing*

Address: 150 Li-Te Road, Peitou, Taipei, Taiwan 112  
Telephone: +886-2-2894-3447  
Fax: +886-2-2894-3449  
Email: info@asus.com.tw

### *Technical Support*

MB/Others (tel): +886-2-2890-7121 (English)  
Notebook (tel): +886-2-2890-7122 (English)  
Desktop/Server (tel): +886-2-2890-7123 (English)  
Fax: +886-2-2895-9254  
Email: tsd@asus.com.tw  
Newsgroup: news2.asus.com.tw  
WWW: www.asus.com.tw  
FTP: ftp.asus.com.tw/pub/ASUS

## ASUS COMPUTER INTERNATIONAL (America)

### *Marketing*

Address: 6737 Mowry Avenue, Mowry Business Center, Building 2  
Newark, CA 94560, USA  
Fax: +1-510-608-4555  
Email: info-usa@asus.com.tw

### *Technical Support*

Fax: +1-510-608-4555  
BBS: +1-510-739-3774  
Email: tsd@asus.com  
WWW: www.asus.com  
FTP: ftp.asus.com/Pub/ASUS

## ASUS COMPUTER GmbH (Europe)

### *Marketing*

Address: Harkortstr. 25, 40880 Ratingen, BRD, Germany  
Fax: +49-2102-4420-66  
Email: sales@asuscom.de

### *Technical Support*

Hotline: MB/Others: +49-2102-9599-0 Notebook: +49-2102-9599-10  
Fax: +49-2102-9599-11  
Online Support: www.asuscom.de/de/support  
WWW: www.asuscom.de  
FTP: ftp.asuscom.de/pub/ASUSCOM

# CONTENTS

---

<b>1. INTRODUCTION .....</b>	<b>7</b>
1.1 How This Manual Is Organized .....	7
1.2 Item Checklist .....	7
<b>2. FEATURES .....</b>	<b>8</b>
2.1 The ASUS MEW-L Motherboard .....	8
2.1.1 Specifications .....	8
2.1.2 Optional Components .....	9
2.1.3 Performance .....	10
2.1.4 Intelligence .....	11
2.2 Motherboard Part Definitions .....	12
2.3 Motherboard Part Locations .....	13
<b>3. HARDWARE SETUP .....</b>	<b>14</b>
3.1 Motherboard Layout .....	14
3.2 Layout Contents .....	15
3.3 Hardware Setup Procedure .....	17
3.4 Motherboard Settings .....	17
3.5 System Memory (DIMM) .....	24
3.5.1 General DIMM Notes .....	24
3.5.2 DIMM Installation .....	25
3.6 Central Processing Unit (CPU) .....	26
3.7 Expansion Cards .....	27
3.7.1 Expansion Card Installation Procedure .....	27
3.7.2 Assigning IRQs for Expansion Cards .....	28
3.7.3 Assigning DMA Channels for ISA Cards .....	30
3.7.4 Audio Modem Riser (AMR) Slot .....	30
3.8 External Connectors .....	31
3.9 Power Connection Procedures .....	45
<b>4. BIOS SETUP .....</b>	<b>46</b>
4.1 Managing and Updating Your BIOS .....	46
4.1.1 Upon First Use of the Computer System .....	46
4.1.2 Updating BIOS Procedures .....	47
4.2 BIOS Setup Program .....	49
4.2.1 BIOS Menu Bar .....	50
4.2.2 Legend Bar .....	50
4.3 Main Menu .....	52
4.3.1 Primary & Secondary Master/Slave .....	53
4.4 Advanced Menu .....	58
4.4.1 Chip Configuration .....	60
4.4.2 I/O Device Configuration .....	62
4.4.3 PCI Configuration .....	64
4.4.4 Shadow Configuration .....	67

# CONTENTS

---

4.5	Power Menu .....	68
4.5.1	Power Up Control .....	70
4.5.2	Hardware Monitor .....	72
4.6	Boot Menu .....	73
4.7	Exit Menu .....	75
<b>5.</b>	<b>SOFTWARE SETUP .....</b>	<b>77</b>
5.1	ASUS Smart Motherboard Support CD .....	77
5.2	Operating Systems .....	80
5.3	Starting Windows For the First Time .....	80
5.4	LDCM Local Setup .....	82
5.5	LDCM Administrator Setup .....	84
5.6	ASUS PC Probe .....	87
5.7	ASUS LiveUpdate .....	88
5.8	Drivers .....	89
5.9	Other .....	91
5.10	Uninstalling Programs .....	98
<b>6.</b>	<b>SOFTWARE REFERENCE .....</b>	<b>101</b>
6.1	Display Properties .....	101
6.2	ASUS PC Probe .....	105
6.3	ASUS LiveUpdate .....	110
6.4	Using Yamaha XGstudio Player .....	111
6.5	Using Yamaha XGstudio Mixer .....	112
6.6	Hardware Information .....	114
<b>7.</b>	<b>APPENDIX .....</b>	<b>115</b>
7.1	PCI-L101 Fast Ethernet Card .....	115
7.2	S370 Series CPU Cards .....	117
7.3	Modem Riser .....	119
<b>INDEX</b>	<b>.....</b>	<b>121</b>

# FCC & DOC COMPLIANCE

---

## ***Federal Communications Commission Statement***

This device complies with FCC Rules Part 15. Operation is subject to the following two conditions:

- This device may not cause harmful interference, and
- This device must accept any interference received, including interference that may cause undesired operation.

This equipment has been tested and found to comply with the limits for a Class B digital device, pursuant to Part 15 of the FCC Rules. These limits are designed to provide reasonable protection against harmful interference in a residential installation. This equipment generates, uses and can radiate radio frequency energy and, if not installed and used in accordance with manufacturer's instructions, may cause harmful interference to radio communications. However, there is no guarantee that interference will not occur in a particular installation. If this equipment does cause harmful interference to radio or television reception, which can be determined by turning the equipment off and on, the user is encouraged to try to correct the interference by one or more of the following measures:

- Re-orient or relocate the receiving antenna.
- Increase the separation between the equipment and receiver.
- Connect the equipment to an outlet on a circuit different from that to which the receiver is connected.
- Consult the dealer or an experienced radio/TV technician for help.

**WARNING!** Any changes or modifications to this product not expressly approved by the manufacturer could void any assurances of safety or performance and could result in violation of Part 15 of the FCC Rules.

Reprinted from the Code of Federal Regulations #47, part 15.193, 1993. Washington DC: Office of the Federal Register, National Archives and Records Administration, U.S. Government Printing Office.

## ***Canadian Department of Communications Statement***

This digital apparatus does not exceed the Class B limits for radio noise emissions from digital apparatus set out in the Radio Interference Regulations of the Canadian Department of Communications.

**This Class B digital apparatus complies with Canadian ICES-003.**

**Cet appareil numérique de la classe B est conforme à la norme NMB-003 du Canada.**

# 1. INTRODUCTION

## 1.1 How This Manual Is Organized

This manual is divided into the following sections:

- |                              |  |
|------------------------------|--|
| 1) <b>INTRODUCTION</b>       | Manual information and checklist                 |
| 2) <b>FEATURES</b>           | Product information and specifications           |
| 3) <b>HARDWARE SETUP</b>     | Instructions on setting up the motherboard       |
| 4) <b>BIOS SETUP</b>         | Instructions on setting up the BIOS software     |
| 5) <b>SOFTWARE SETUP</b>     | Instructions on setting up the included software |
| 6) <b>SOFTWARE REFERENCE</b> | Reference material for the included software     |
| 7) <b>APPENDIX</b>           | Optional items                                   |

## 1.2 Item Checklist

Check that your package is complete. If you discover damaged or missing items, please contact your retailer.

- (1) ASUS Motherboard
- (1) 80-conductor ribbon cable for internal UltraDMA/66 or UltraDMA/33 IDE drives  
**NOTE:** The 80-conductor ribbon cable is designed with a 40-pin connector.
- (1) Ribbon cable for (1) 5.25" and (2) 3.5" floppy disk drives
- (1) Bag of spare jumper caps
- (1) Support CD with drivers and utilities
- (1) This Motherboard User's Manual
  
- I/O Shield (for LAN model only; metallic plate which replaces the chassis' provided standard ATX connector shield)
- Serial COM2 connector with bracket (for non-LCD model only)
- LCD panel & Serial COM2 connector with bracket (for LCD model only)
- ASUS IrDA-compliant Infrared module (optional)
- ASUS consumer infrared set (optional)

## 2. FEATURES

---

### 2.1 The ASUS MEW-L Motherboard

The MEW-L motherboard from ASUS is carefully designed for the demanding PC user who wants many smart features in a small package. So what's so smart about the ASUS MEW-L motherboard?

#### 2.1.1 Specifications

- **Latest Intel Socket 370 Processor Support!** Supports Intel's Celeron processor designed for Socket 370 and packaged in **Plastic Pin Grid Array (PPGA)**.
- **Latest Intel 810 Chipset!** Features 100MHz FSB Intel 810 chipset (GMCH0 & ICH) and a 24-bit 230MHz RAMDAC graphics controller.
- **Integrated Graphics!** Controller supports 3D hyper pipelined architecture, parallel data processing and compression, precise pixel interpolation, full 2D hardware acceleration, and motion video acceleration.
- **ASUS Graphics Driver!** You can gain about 12% performance over that of the standard graphics driver (2D highend graphics WinMark) using ASUS' custom graphics driver. ASUS custom graphics driver also provides more features and provides selection of higher refresh rates and resolutions.
- **Versatile Memory Support!** DRAM controller supports asymmetrical addressing and three DIMM sockets support Intel PC100-compliant SDRAMs (16, 32, 64, 128, or 256MB) up to 512MB. (supports a maximum of 4 sides)
- **JumperFree™ Mode!** Allows processor settings and easy overclocking of frequency and Vcore voltage all through BIOS setup when JumperFree™ mode is enabled. Easy-to-use DIP switches instead of jumpers are included in case you want to manually adjust the processor's external frequency.
- **Smart Slots!** Optional five 32-bit PCI (rev 2.2) with two 16-bit ISA expansion slots, six PCI with one ISA, or six PCI with no ISA, depending on territory. PCI supports up to 133MB/sec maximum throughput. Each PCI slot can support a Bus Master PCI card (such as SCSI or LAN cards).
- **Latest Low Pin Count Multi-I/O:** Provides two high-speed UART compatible serial ports and one parallel port with EPP and ECP capabilities.
- **Integrated IDE!** Controller supports UltraDMA/66 up to 66MB/s, UltraDMA/33 up to 33MB/s, and PIO Mode 4 up to 17MB/s.
- **Peripheral Wake-Up!** Supports Wake-On-LAN, Wake-On-Ring, Keyboard Wake-Up, BIOS Wake-Up, and wake-up by infrared remote control.
- **AMR Slot!** Audio Modem Riser slot supports a very affordable audio and/or modem riser card.
- **Around-the-Clock Intrusion Detection!** Supports chassis intrusion monitoring through the ASUS ASIC. The onboard battery supports detection even when normal power is removed and through a new design, battery drain is even lower than the RTC used for keeping time!
- **Firmware Hub!** Provides security and other latest power computing features.



## 2. FEATURES

---

- **Monitoring for your PC's Health!** Provided ASUS PC Probe or Intel LDCM allows PC health monitoring.
- **Enhanced ACPI & Anti-Boot Virus Protection!** Programmable BIOS (Flash EEPROM), offering enhanced ACPI for Windows 98 compatibility, built-in firmware-based virus protection, and autodetection of most devices for virtually automatic setup.
- **Smart BIOS!** 4Mbit firmware gives a new easy-to-use interface which provides more control and protection over the motherboard. Provides Vcore and CPU/SDRAM frequency adjustments, boot block write protection, and HD/SCSI/MO/ZIP/CD/Floppy boot selection. Hardware random number generator supports new security software for data protection and secured Internet transactions.
- **Wired for Management (WfM) V2.0!** Supports remote monitor, diagnosis, and management (Alert-On-LAN) in network configuration.

### 2.1.2 Optional Components

The following onboard components are optional at the time of purchase:

- **Smart Audio!** Software Audio and Hardware AC'97 V2.1 CODEC compliant, Analog Device's 3D sound circuitry, sample rate conversion from 7kHz to 48kHz. Full amplified audio output can be directed to the chassis' internal speaker in order to save space, save money, and reduce complications associated with external speakers. Chassis speaker volume can be digitally controlled through OS.
- **3D Positional Audio!** Brings new levels of realism to games with sounds being positioned interactively around the user, making them truly part of the 3D virtual experience. Better music reproduction is possible with MIDI utilizing Wavetable synthesis.
- **Smart Networking!** Features the Intel 82559 Fast-Ethernet LAN Controller (fully integrated 10BASE-T/100BASE-TX). Supports TCO function.
- **Space Savings!** Digital Flat Panel (DFP) Interface gives a direct digital connection for connecting a **digital** flat panel (analog flat panel must be connected to the VGA-out connector) to your PC. This interface transmits sharp, bright images by eliminating digital-to-analog and analog-to-digital conversions, which can accumulate noise and degrade image quality.
- **No Messy Wires!** Integrated Consumer IR and Standard IR support an optional remote control package for wireless interfacing with external peripherals, personal gadgets, or an optional remote controller.

## 2. FEATURES

---

### 2.1.3 Performance

- **UltraPerformance!** Onboard IDE Bus Master controller with two connectors that support four IDE devices in two channels. Supports UltraDMA/66, UltraDMA/33 (IDE DMA Mode 2), PIO Modes 3 & 4, and supports Enhanced IDE devices, such as Tape Backup, CD-ROM, CD-R/RW, and LS-120 drives.
- **Dual Speeds!** CPU frequency can operate at either 66MHz or 100MHz while system memory operates at either 100MHz or 66MHz. (100MHz CPU with 66MHz SDRAM setting not supported) This asynchronous design can optimize the VGA performance under shared memory configuration. Of course 100MHz/100MHz synchronous host/DRAM clock is recommended for maximum performance.
- **Double or Quadruple the IDE Transfer Speed!** IDE transfers using UltraDMA/33 Bus Master IDE can handle rates up to 33MB/s and up to 66MB/s using UltraDMA/66 technology. The best of all is that these new technology is compatible with existing ATA-2 IDE specifications so there is no need to upgrade current IDE devices or cables.
- **Concurrent PCI!** Concurrent PCI allows multiple PCI transfers from PCI master buses to memory to CPU.
- **SDRAM Optimized Performance!** ASUS smart series motherboards support the new generation memory, Synchronous Dynamic Random Access Memory (SDRAM), which increases the data transfer rate to 800MB/s max using PC100-compliant SDRAM.
- **ACPI Ready!** ACPI (Advanced Configuration and Power Interface) is also implemented on all ASUS smart series motherboards. ACPI provides more Energy Saving Features for future operating systems (OS) supporting OS Direct Power Management (OSPM) functionality. With these features implemented in the OS, PCs can be ready around the clock, yet satisfy all the energy saving standards. To fully utilize the benefits of ACPI, an ACPI-supported OS such as Windows 98 must be used.
- **Suspend and Go!** Suspend-to-RAM (STR) and suspend-to-disk provides maximum power savings as an alternative to leaving the computer ON and QuickStart™ so that you do not fall asleep waiting for system bootup. (STR requires OS support and does not support ISA cards; ISA cards may fail to work coming out of STR mode.)
- **Windows 2000 Ready!** The new-generation operating system provides smart management, web integration, multilanguage support, and higher level of performance, reliability, and security.
- **Highest Audio Quality!** AC'97 DAC/ADC built into the audio CODEC reduces noise to improve audio quality and performance for a SNR (signal to noise ratio) of +90dB. These features greatly improve voice synthesis and recognition.
- **Extreme Graphics!** The integrated motion compensation allows for smooth MPEG1 or MPEG2 video playback. Fast 3D graphics engine allows for an exciting gameplay experience.

## 2. FEATURES

---

### 2.1.4 Intelligence

- **Fan Status Monitoring and Alarm!** To prevent system overheat and system damage, the CPU, power supply, and system fans can be monitored for RPM and failure. All the fans are set for its normal RPM range and alarm thresholds.
- **Temperature Monitoring and Alert!** To prevent system overheat and system damage, this motherboard supports Socket 370 processor thermal sensing and auto-protection.
- **Voltage Monitoring and Alert!** System voltage levels are monitored to ensure stable current to critical motherboard components. Voltage specifications are more critical for future processors, so monitoring is necessary to ensure proper system configuration and management.
- **System Resources Alert!** Today's operating systems such as Windows 98, Windows NT, and OS/2, require much more memory and hard drive space to present enormous user interfaces and run large applications. The system resource monitor will warn the user before the system resources are used up to prevent possible application crashes. Suggestions will give the user information on managing their limited resources more efficiently.
- **Dual Function Power Button!** Through BIOS, the power button can be defined as the "Standby" (a.k.a. Suspend or Sleep) button or as the Soft-Off (see ATX Power Switch in *3.8 External Connectors* for more information) button. Regardless of the setting, pushing the power button for more than 4 seconds will enter the Soft-Off mode.
- **Remote Ring On (requires modem)!** This allows a computer to be turned on remotely through an internal or external modem. With this benefit on-hand, users can access any information from their computers from anywhere in the world!
- **Message LED (requires ACPI OS support)!** Chassis LEDs now act as information providers. Through the way a particular LED illuminates, the user can determine the stage the computer is in. A simple glimpse provides useful information to the user.
- **Peripheral Power Up!** Keyboard or Mouse power up can be enabled or disabled through BIOS setup to allow the computer to be powered ON using your keyboard or mouse.

## 2. FEATURES

---

### 2.2 Motherboard Part Definitions

The following are part descriptions for the motherboard parts shown on the next page.

- 1 **ATX Power Connector for connection to an ATX power supply**
- 2 **LCD Header for LCD connector set (LCD model only)**
- 3 **LCD Chipset (on LCD model only)**
- 4 **Socket 370 for Intel Celeron 370 processors**
- 5 **Intel 810 (GMCH0) Integrated Graphics Chipset**
- 6 **Three DIMM Sockets**
- 7 **Primary and Secondary IDE Connectors**
- 8 **Feature Setting DIP Switches**
- 9 **Floppy Disk Drive Connector**
- 10 **Serial COM2 Header**
- 11 **Intel I/O Controller Hub (ICH)**
- 12 **Low Pin Count Multi-I/O Chipset**
- 13 **Four Mbit Firmware Hub (programmable BIOS)**
- 14 **Wake-On-Ring Connector**
- 15 **Wake-On-LAN Connector**
- 16 **One or Two ISA Slot(s) (on ISA model only)**
- 17 **PCI to ISA Bridge (on ISA model only)**
- 18 **Intel 82559 Fast-Ethernet Chipset (on LAN model only)**
- 19 **AC'97 V2.1 Audio CODEC**
- 20 **Five or Six PCI Slots (optional at the time of purchase)**
- 21 **Audio Modem Riser (AMR) Connector**
- 22 **Joystick, MIDI, Line Out, Line In, Microphone In Connectors**
- 23 **VGA Monitor Output Connector**
- 24 **Parallel Connector**
- 25 **Serial COM1 Connector**
- 26 **LAN (RJ45) and USB Connectors (LAN optional)**
- 27 **PS/2 Mouse, PS/2 Keyboard Connectors**

# 2. FEATURES

## 2.3 Motherboard Part Locations

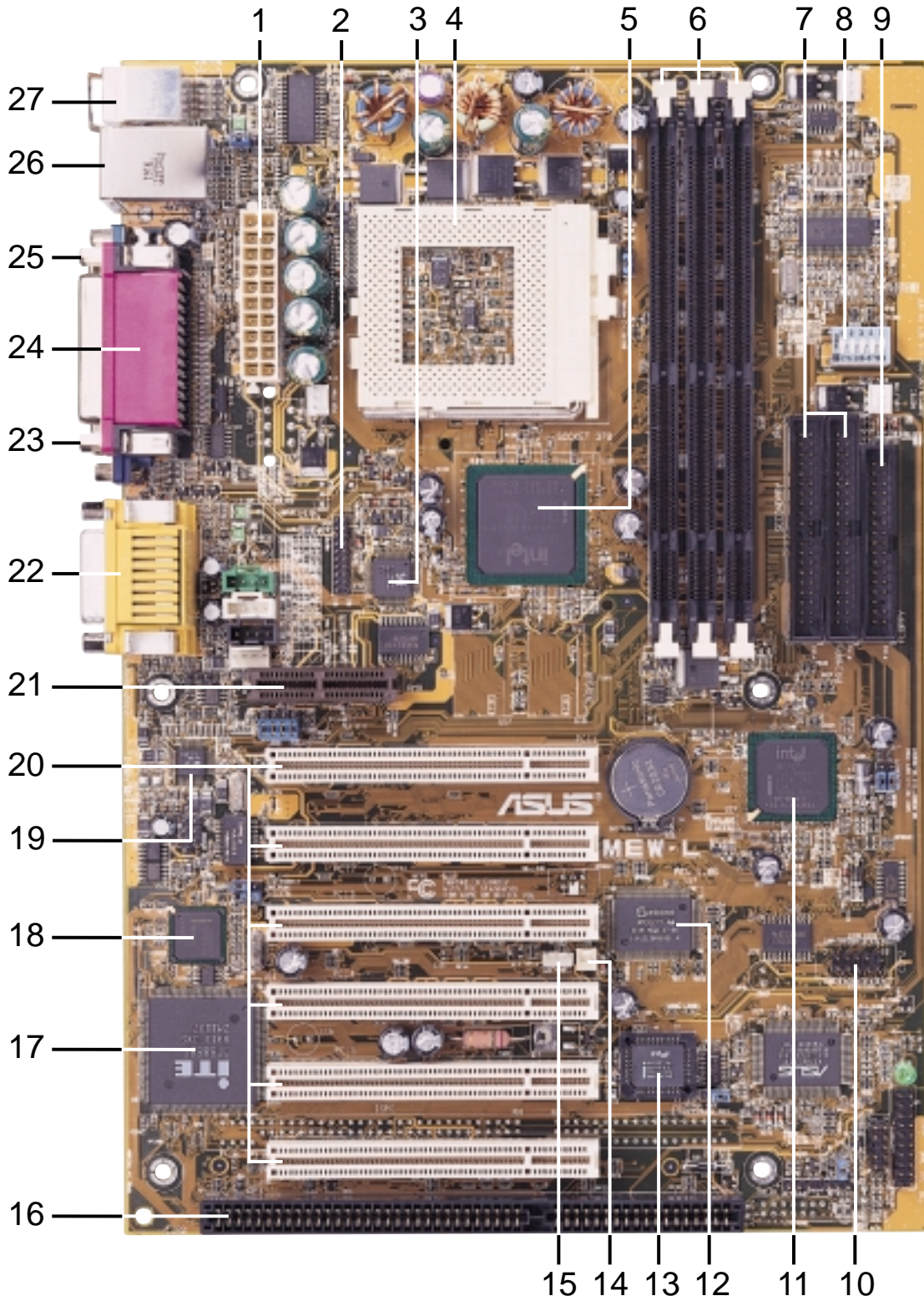

2. FEATURES  
Part Locations

**NOTE:** The ISA model is shown above. One or two ISA slots are optional at the time of purchase. The model with two ISA will have only 5 PCI slots.

# 3. HARDWARE SETUP

## 3.1 Motherboard Layout

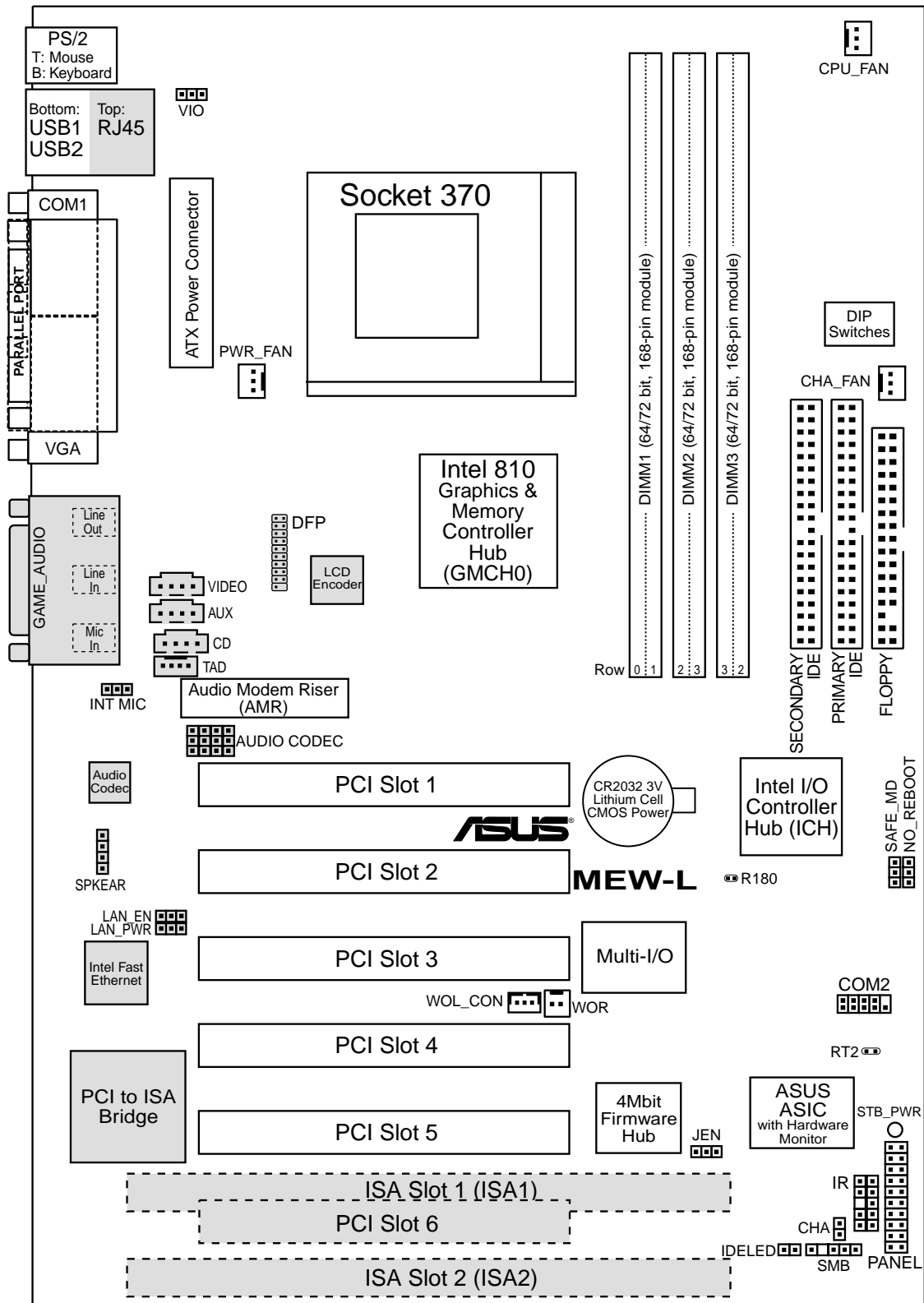

(Grayed items are optional at the time of purchase.)

# 3. HARDWARE SETUP

## 3.2 Layout Contents

### Motherboard Settings

- |                |  |
|----------------|--|
| 1) JEN         | p.18 JumperFree™ Mode (Enable/Disable)           |
| 2) VIO         | p.19 I/O Voltage Setting (Normal/+3.66V)         |
| 3) AUDIO CODEC | p.19 Onboard Audio Setting (Enable/Disable)      |
| 4) LAN_EN      | p.20 Onboard LAN Setting (Enable/Disable)        |
| 5) LAN_PWR     | p.20 Onboard LAN Power Setting (Normal/Standby)  |
| 6) SAFE_MD     | p.21 Safe Mode (Normal/Safe Mode)                |
| 7) NO_REBOOT   | p.21 Automatic Timeout Reboot (Normal/No Reboot) |
| 8) DSW         | p.22 CPU External Clock (BUS) Frequency Setting  |

### Expansion Slots

- |                                 |   |
|---------------------------------|---|
| 1) DIMM1, DIMM2, DIMM3          | p.24 168-Pin DIMM Memory Support                    |
| 2) Socket 370                   | p.26 Central Processing Unit (CPU) Socket           |
| 3) ISA1, ISA2                   | p.27 16-bit ISA Bus Expansion Slots (optional)      |
| 4) PCI1, PCI2, PCI3, PCI4, PCI5 | p.27 32-bit PCI Bus Expansion Slots (optional PCI6) |
| 5) AMR                          | p.30 Audio Modem Riser Slot                         |

### Connectors

- |                           |  |
|---------------------------|--|
| 1) PS2KBMS                | p.31 PS/2 Mouse Connector (6-pin female)                     |
| 2) PS2KBMS                | p.31 PS/2 Keyboard Connector (6-pin female)                  |
| 3) USB                    | p.32 Universal Serial Bus Ports 1 & 2 (Two 4-pin female)     |
| 4) PRINTER                | p.32 Parallel Port Connector (25-pin female)                 |
| 5) COM1                   | p.32 Serial Port COM1 Connector (9-pin male)                 |
| 6) VGA                    | p.33 Monitor (VGA) Output Connector (15-pin female)          |
| 7) GAME_AUDIO             | p.33 Joystick/MIDI Connector (15-pin female) (optional)      |
| 8) GAME_AUDIO             | p.33 Audio Port Connectors (Three 1/8" female) (optional)    |
| 9) RJ45                   | p.33 Fast-Ethernet Port Connector (RJ45) (optional)          |
| 10) PRIMARY/SECONDARY IDE | p.34 Primary/Secondary IDE Connectors (Two 40-1pins)         |
| 11) FLOPPY                | p.34 Floppy Disk Drive Connector (34-1pins)                  |
| 12) WOL_CON               | p.35 Wake-On-LAN Connector (3 pins)                          |
| 13) WOR                   | p.35 Wake-On-Ring Connector (2 pins)                         |
| 14) IDELED                | p.36 IDE Activity LED (2 pins)                               |
| 15) CHA_, CPU_, PWR_FAN   | p.36 Chassis, CPU, Power Supply Fan Connectors (Three 3-pin) |
| 16) VIDEO, AUX, CD, TAD   | p.37 Internal Audio Connectors (Four 4-pins) (optional)      |
| 17) INT_SPKA              | p.37 Internal Speaker Connector (4-pins) (optional)          |
| 18) IR (CIR/SIR)          | p.38 Infrared Module Connector (10-1 pins)                   |
| 19) COM2                  | p.38 Serial Port COM2 Header (10-1 pins)                     |

# 3. HARDWARE SETUP

---

20) SMB	p.39 SMBus Connector (5-1 pins)
21) DFP	p.39 Digital LCD Header (20-1 pins) (optional)
22) INT MIC	p.40 Internal Microphone Connector (3 pins)
23) CHA	p.41 Chassis Intrusion Connector (2 pins)
24) ATXPWR	p.41 ATX Power Supply Connector (20 pins)
25) SPEAKER (PANEL)	p.43 System Warning Speaker Connector (4 pins)
26) KEYLOCK (PANEL)	p.43 Keyboard Lock Switch Lead (2 pins)
27) PLED (PANEL)	p.43 System Power LED Lead (3-1 pins)
28) RESET (PANEL)	p.43 Reset Switch Lead (2 pins)
29) PWRSW (PANEL)	p.43 ATX Power / Soft-Off Switch Lead (2 pins)
30) SMI (PANEL)	p.43 System Management Interrupt Switch Lead (2 pins)
31) LED (PANEL)	p.43 System Message LED (2 pins)



# 3. HARDWARE SETUP

## 3.3 Hardware Setup Procedure

Before using your computer, you must complete the following steps:

- **Check Motherboard Settings**
- **Install Memory Modules**
- **Install the Central Processing Unit (CPU)**
- **Install Expansion Cards**
- **Connect Ribbon Cables, Panel Wires, and Power Supply**

## 3.4 Motherboard Settings

This section explains in detail how to change your motherboard's function settings through the use of switches and/or jumpers.

**WARNING!** Computer motherboards and expansion cards contain very delicate Integrated Circuit (IC) chips. To protect them against damage from static electricity, you should follow some precautions whenever you work on your computer.

1. Unplug your computer when working on the inside.
2. Use a grounded wrist strap before handling computer components. If you do not have one, touch both of your hands to a safely grounded object or to a metal object, such as the power supply case.
3. Hold components by the edges and try not to touch the IC chips, leads or connectors, or other components.
4. Place components on a grounded antistatic pad or on the bag that came with the component whenever the components are separated from the system.

### Motherboard Feature Settings (DSW)

Besides jumper settings, some of the motherboard's onboard functions are adjusted through the DIP switches. The white block represents the switch's position. The example below shows all the switches in the OFF position.

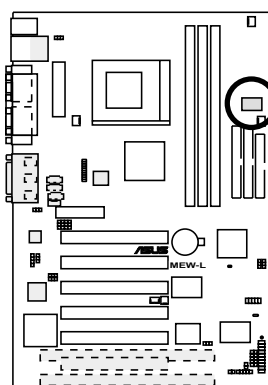

MEW-L DIP Switches

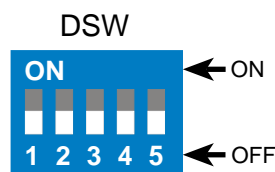

1. Frequency Selection
2. Frequency Selection
3. Frequency Selection
4. Frequency Selection
5. Frequency Selection

# 3. HARDWARE SETUP

## 1) JumperFree™ Mode Setting (JEN)

This jumper allows you to enable or disable the JumperFree™ mode. The JumperFree™ mode allows processor settings to be made through the BIOS setup (see *4.4 Advanced Menu*).

**NOTE:** For JumperFree™ mode, all dip switches (DSW) must be set to OFF.

<u>Setting</u>	<u>JEN</u>
Disable (Jumper)	[1-2]
Enable (JumperFree)	[2-3] (default)

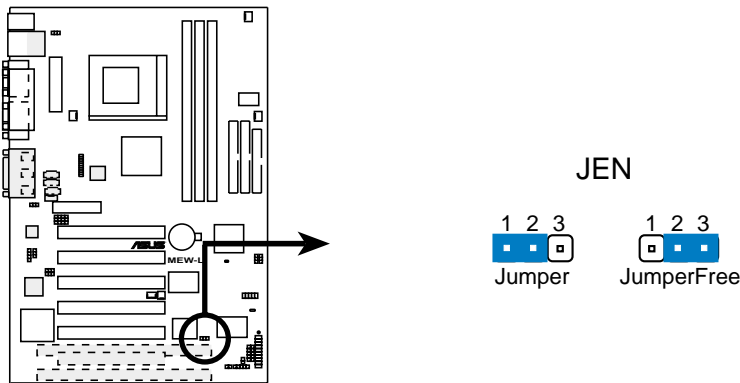

**MEW-L JumperFree™ Mode Setting**

# 3. HARDWARE SETUP

## 2) I/O Voltage Setting (VIO)

This jumper allows you to select the voltage supplied to the DRAM, chipset, PCI, and the CPU's I/O buffer. The default voltage should be used unless processor overclocking requires a higher voltage.

Setting	VIO
Normal	[1-2] (default)
3.66V	[2-3]

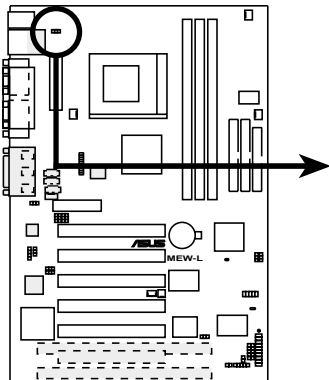

MEW-L VIO Setting

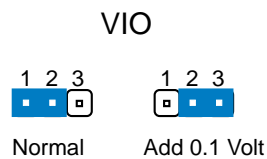

**WARNING!** Using a higher voltage may help when overclocking but may result in the shortening of your computer component's life. It is strongly recommended that you leave this setting on its default.

## 3) Onboard Audio Setting (AUDIO CODEC)

The onboard audio CODEC may be enabled or disabled using all of these jumpers. Disable the onboard audio CODEC if you are using an ISA or PCI audio card on any of the expansion slots or a primary AMR on the AMR slot (see AMR Slot later in this section). If using an ISA or PCI audio expansion card, **Onboard AC'97 Audio Controller** in *4.4.2 I/O Device Configuration* must also be disabled.

Setting	AUDIO CODEC
Enable	[1-2] [1-2] [1-2] [1-2] (default)
Disable	[2-3] [2-3] [2-3] [2-3]

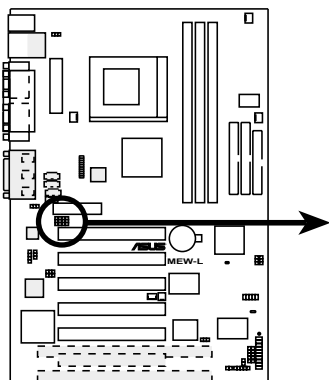

MEW-L Audio Codec Setting

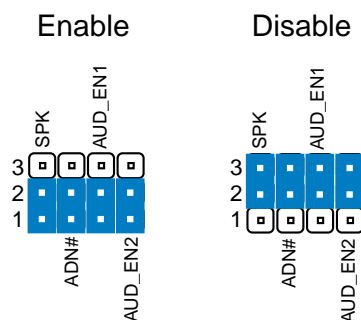

# 3. HARDWARE SETUP

- 4) **Onboard LAN Setting (LAN\_EN) available on LAN model only**  
The onboard LAN may be enabled or disabled by this jumper.

<u>Setting</u>	<u>LAN_EN</u>
Enable	[1-2] (default)
Disable	[2-3]

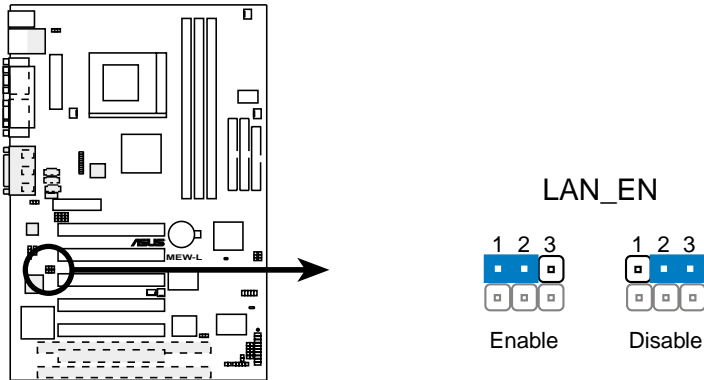

**MEW-L LAN Setting**

- 5) **Onboard LAN Power Setting (LAN\_PWR) available on LAN model only**  
The onboard LAN power may be set to normal or standby power. Select **Normal** if you do not have a power supply with 720mA standby power. Selecting **Standby** will allow the use of Wake-On-LAN but may not allow system bootup if the power supply's standby power is insufficient.

<u>Setting</u>	<u>LAN_PWR</u>
Normal	[1-2]
Standby	[2-3] (default)

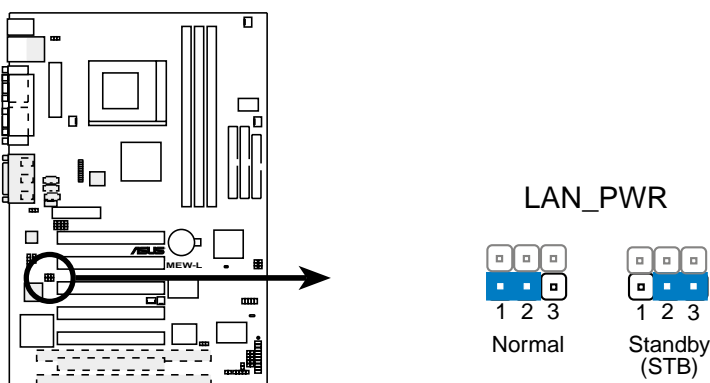

**MEW-L LAN Power Setting**

# 3. HARDWARE SETUP

## 6) Safe Mode Setting (SAFE\_MD)

Usually socket 370 processors have locked frequency multiples. In this case, there is no way to exceed the specified multiple whether through motherboard settings or BIOS setup. With unlocked socket 370 processors, exceeding the specified multiple is possible through BIOS setup. Exceeding the specified multiple may result in hanging during bootup. If this occurs, enable Safe Mode to force a multiple of 2 in order to enter BIOS setup to correct the problem.

<u>Setting</u>	<u>SAFE_MD</u>
Normal	[1-2] (default)
Safe Mode	[2-3]

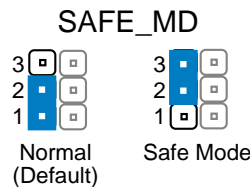
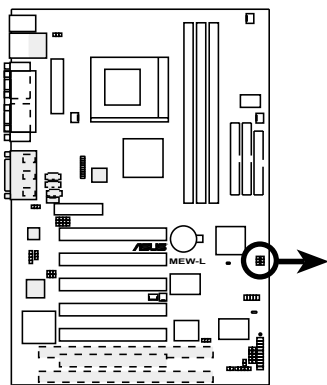

**MEW-L Safe Mode Setting**

## 7) Automatic Timeout Reboot Setting (NO\_REBOOT)

The motherboard is set so that when the BIOS detects a hang (timeout) during bootup, the motherboard will automatically reboot. If rebooting is repeating ineffectively, set this jumper to “No Reboot” so that auto-reboot will be disabled.

<u>Setting</u>	<u>NO_REBOOT</u>
Normal	[1-2] (default)
No Reboot	[2-3]

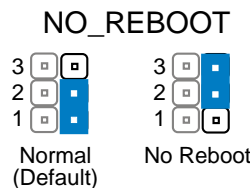
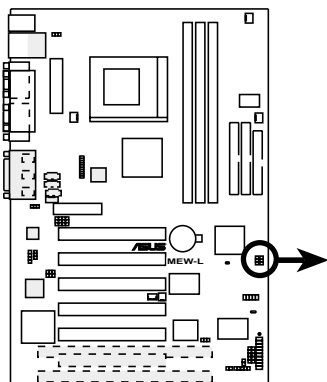

**MEW-L Reboot Setting**

# 3. HARDWARE SETUP

## 8) CPU External Frequency Setting (DSW)

This option tells the clock generator what frequency to send to the CPU, DRAM, and the PCI bus. This allows the selection of the CPU's *External* frequency. The CPU External Frequency multiplied by the Frequency Multiple equals the CPU's *Internal* frequency (the advertised CPU speed). **NOTE:** You may set the memory speed independently from the CPU External Frequency. Depending on your memory type PC66 (66MHz) or PC100 (100MHz), select the appropriate "SDRAM" speed along with the appropriate "CPU" speed.

**IMPORTANT:** Only 66MHz CPU and 100MHz SDRAM should be used on this motherboard with current 66MHz Socket 370 processors. Other settings are for experienced users only. When JumperFree mode is enabled, use BIOS setup in place of these switches (see **CPU Speed** in *4.4 Advanced Menu*). Only selected switches are illustrated, see the next page for a complete frequency listing. **NOTE:** For JumperFree mode, all dip switches (DSW) must be set to OFF.

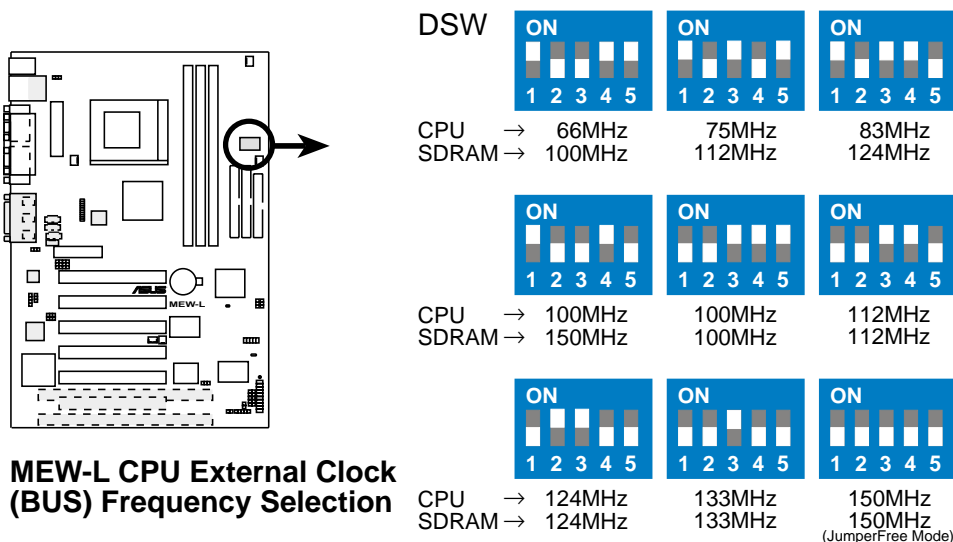

**NOTE:** Frequency Multiple settings are not available here because usually Socket 370 processors have locked Frequency Multiples. If your Socket 370 processor does not have a locked Frequency Multiple, you must use **CPU Core:Bus Freq. Multiple** in *4.4 Advanced Menu* of the BIOS setup to set the Frequency Multiple. If the Frequency Multiple is locked, setting the Frequency Multiple in BIOS setup will have no effect.

**WARNING!** CPU frequencies above 66MHz exceed the specifications for current Celeron processors and are not guaranteed to be stable. Premature wearing of the processor may result when overclocking. Be sure that the DIMM you use can handle the specified SDRAM MHz or else bootup will not be possible.

# 3. HARDWARE SETUP

## *External Frequency Table for Intel Celeron (PPGA) Processors*

The following table is for use by experienced motherboard installers only. Overclocking can result in system instability or even shortening the life of the processor. Bold settings are also shown on the previous page.

CPU (MHz)	SDRAM (MHz)	PCI (MHz)	Frequency Selection Switches				
			1	2	3	4	5
67.81	101.71	33.90	[ON]	[ON]	[ON]	[ON]	[ON]
70.00	105.00	35.00	[ON]	[OFF]	[ON]	[ON]	[ON]
72.01	108.01	36.00	[ON]	[ON]	[OFF]	[ON]	[ON]
<b>66.67</b>	<b>100.00</b>	33.33	[ON]	[OFF]	[OFF]	[ON]	[ON]
73.01	109.51	36.50	[ON]	[ON]	[ON]	[OFF]	[ON]
<b>75.00</b>	<b>112.50</b>	37.50	[ON]	[OFF]	[ON]	[OFF]	[ON]
77.00	115.50	38.50	[ON]	[ON]	[OFF]	[OFF]	[ON]
78.01	117.01	39.00	[ON]	[OFF]	[OFF]	[OFF]	[ON]
80.00	120.00	40.00	[ON]	[ON]	[ON]	[ON]	[OFF]
<b>83.00</b>	<b>124.51</b>	41.50	[ON]	[OFF]	[ON]	[ON]	[OFF]
84.49	126.74	42.25	[ON]	[ON]	[OFF]	[ON]	[OFF]
<b>100.00</b>	<b>150.00</b>	50.00	[ON]	[OFF]	[OFF]	[ON]	[OFF]
86.08	129.12	43.04	[ON]	[ON]	[ON]	[OFF]	[OFF]
88.00	132.00	44.00	[ON]	[OFF]	[ON]	[OFF]	[OFF]
90.00	135.00	45.00	[ON]	[ON]	[OFF]	[OFF]	[OFF]
95.00	142.50	47.50	[ON]	[OFF]	[OFF]	[OFF]	[OFF]
49.90	49.90	16.63	[OFF]	[ON]	[ON]	[ON]	[ON]
<b>100.00</b>	<b>100.00</b>	33.33	[OFF]	[OFF]	[ON]	[ON]	[ON]
74.85	74.85	24.95	[OFF]	[ON]	[OFF]	[ON]	[ON]
66.58	66.58	22.19	[OFF]	[OFF]	[OFF]	[ON]	[ON]
82.84	82.84	27.61	[OFF]	[ON]	[ON]	[OFF]	[ON]
89.81	89.81	29.93	[OFF]	[OFF]	[ON]	[OFF]	[ON]
94.80	94.80	31.60	[OFF]	[ON]	[OFF]	[OFF]	[ON]
100.50	100.50	33.50	[OFF]	[OFF]	[OFF]	[OFF]	[ON]
104.78	104.78	34.93	[OFF]	[ON]	[ON]	[ON]	[OFF]
<b>111.77</b>	<b>111.77</b>	37.26	[OFF]	[OFF]	[ON]	[ON]	[OFF]
114.77	114.77	38.26	[OFF]	[ON]	[OFF]	[ON]	[OFF]
100.00	100.00	33.33	[OFF]	[OFF]	[OFF]	[ON]	[OFF]
<b>123.75</b>	<b>123.75</b>	41.25	[OFF]	[ON]	[ON]	[OFF]	[OFF]
<b>132.74</b>	<b>132.74</b>	44.25	[OFF]	[OFF]	[ON]	[OFF]	[OFF]
139.75	139.75	46.58	[OFF]	[ON]	[OFF]	[OFF]	[OFF]
<b>149.69</b>	<b>149.69</b>	49.90	[OFF]	[OFF]	[OFF]	[OFF]	[OFF]

**NOTE:** The PCI clock is equal to 1/3 the speed of the SDRAM. PCI's specification allows for up to 33MHz, therefore using PC100-compliant DIMM and setting SDRAM to about 100MHz is recommended. For updated processor settings, please visit ASUS' web site (see ASUS CONTACT INFORMATION)

# 3. HARDWARE SETUP

## 3.5 System Memory (DIMM)

**NOTE:** No hardware or BIOS setup is required after adding or removing memory.

This motherboard uses only Dual Inline Memory Modules (DIMMs). Sockets are available for **3.3Volt** (power level) unbuffered Synchronous Dynamic Random Access Memory (SDRAM) of 16, 32, 64, 128MB, or 256MB.

This chipset does not support ECC. However, ECC memory modules may still be used, but the ECC function will not be available.

Memory speed setup is recommended through **SDRAM Configuration** in **4.4.1 Chip Configuration**.

*Install memory in any combination as follows:*

Location	168-pin DIMM SDRAM		Total Memory
DIMM1 (Rows 0&1)	Single-Sided Double-Sided	x1	
DIMM2 (Rows 2&3)	Single-Sided (must be occupied before DIMM3) Double-Sided (DIMM3 must be empty)	x1	
DIMM3 (Rows 3&2)	Single-Sided (DIMM2 must be single-sided) (Double-Sided DIMM cannot be used here!) (must be same or half DIMM2 memory size)	x1	
<b>Total System Memory (Max 512MB)</b>		=	

### 3.5.1 General DIMM Notes

- When this motherboard operates at 100MHz, PC100-compliant modules must be used because of the strict timing issues involved under this speed. If your DIMMs are not PC100-compliant, set the SDRAM bus frequency to 66MHz RAM but onboard graphics performance and PCI expansion cards will suffer tremendously.
- ASUS motherboards support SPD (Serial Presence Detect) DIMMs. This is the memory of choice for best performance vs. stability.
- SDRAM chips are generally thinner with higher pin density than EDO (Extended Data Output) chips.
- BIOS shows SDRAM memory on bootup screen.
- Single-sided DIMMs come in 16, 32, 64,128MB; double-sided come in 32, 64, 128, 256MB.



# 3. HARDWARE SETUP

## 3.5.2 DIMM Installation

Insert the module(s) as shown. Because the number of pins are different on either side of the breaks, the module will only fit in the orientation shown. DIMMs are longer and have different pin contact on each side and therefore have a higher pin density. SIMMs have the same pin contact on both sides.

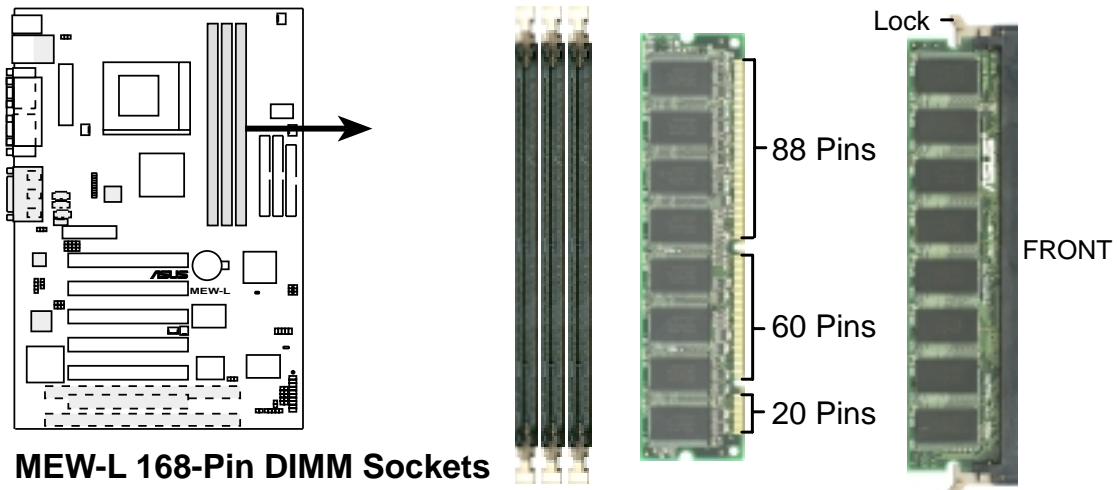

**MEW-L 168-Pin DIMM Sockets**

The DIMMs must be **3.3V Unbuffered** for this motherboard. To determine the DIMM type, check the notches on the DIMMs (see figure below).

### 168-Pin DIMM Notch Key Definitions (3.3V)

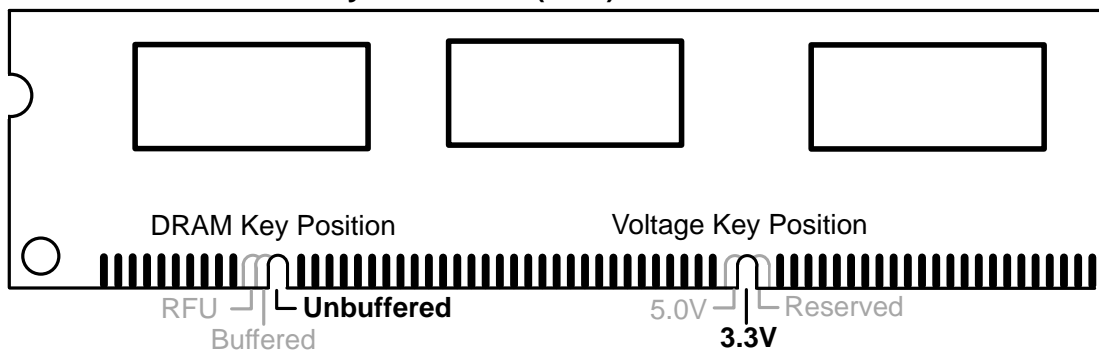

The notches on the DIMM will shift between left, center, or right to identify the type and also to prevent the wrong type from being inserted into the DIMM slot on the motherboard. You must ask your retailer the correct DIMM type before purchasing. This motherboard supports four clock signals per DIMM socket.

# 3. HARDWARE SETUP

## 3.6 Central Processing Unit (CPU)

The motherboard provides a ZIF Socket 370. The CPU that came with the motherboard should have a fan attached to it to prevent overheating. If this is not the case, then purchase a fan before you turn on your system.

**WARNING!** Be sure that there is sufficient air circulation across the processor's heatsink by regularly checking that your CPU fan is working. Without sufficient circulation, the processor could overheat and damage both the processor and the motherboard. You may install an auxiliary fan, if necessary.

To install a CPU, first turn off your system and remove its cover. Locate the ZIF socket and open it by first pulling the lever sideways away from the socket then upwards to a 90-degree angle. Insert the CPU with the correct orientation as shown. The notched corner should point towards the end of the lever. Because the CPU has a corner pin for two of the four corners, the CPU will only fit in the orientation as shown. The picture is for reference only; you should have a CPU fan that covers the face of the CPU. With the added weight of the CPU fan, no force is required to insert the CPU. Once completely inserted, close the socket's lever while holding down the CPU.

**NOTE:** Do not forget to set the correct Bus Frequency and Multiple (frequency multiple setting is available only on unlocked processors) for your Socket 370 processor or else boot-up may not be possible. Socket 370 processors provide internal thermal sensing so that a socket mounted thermal resistor is not needed.

**CAUTION!** Be careful not to scrape the motherboard when mounting a clamp-style processor fan or else damage may occur to the motherboard.

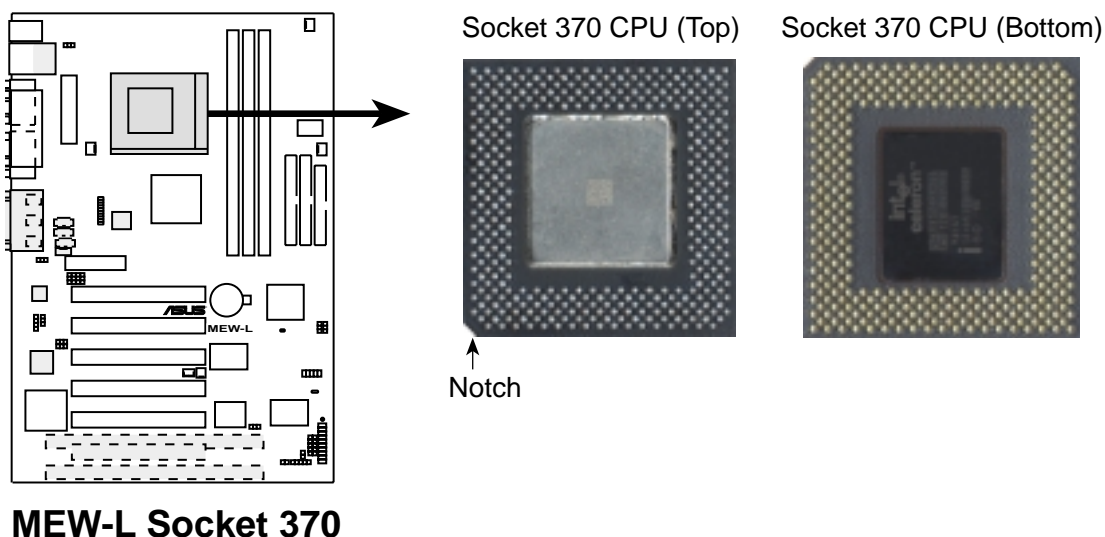

# 3. HARDWARE SETUP

---

## 3.7 Expansion Cards

**WARNING!** Unplug your power supply when adding or removing expansion cards or other system components. Failure to do so may cause severe damage to both your motherboard and expansion cards.

### 3.7.1 Expansion Card Installation Procedure

1. Read the documentation for your expansion card and make any necessary hardware or software settings for your expansion card, such as jumpers.
2. Remove your computer system's cover and the bracket plate on the slot you intend to use. Keep the bracket for possible future use.
3. Carefully align the card's connectors and press firmly.
4. Secure the card on the slot with the screw you removed above.
5. Replace the computer system's cover.
6. Set up the BIOS if necessary  
(such as *IRQ xx Used By ISA: Yes* in **4.4.3 PCI Configuration**)
7. Install the necessary software drivers for your expansion card.

# 3. HARDWARE SETUP

## 3.7.2 Assigning IRQs for Expansion Cards

Some expansion cards need an IRQ to operate. Generally, an IRQ must be exclusively assigned to one use. In a standard design, there are 16 IRQs available but most of them are already in use, leaving 6 IRQs free for expansion cards. If your motherboard has **PCI** audio onboard, an additional IRQ will be used. If your motherboard also has **MIDI** enabled, another IRQ will be used, leaving 4 IRQs free.

The following table lists the default IRQ assignments for standard PC devices. Use this table when configuring your system and for resolving IRQ conflicts.

### *Standard Interrupt Assignments*

<b>IRQ</b>	<b>Priority</b>	<b>Standard Function</b>
0	1	System Timer
1	2	Keyboard Controller
2	N/A	Programmable Interrupt
3*	11	Communications Port (COM2)
4*	12	Communications Port (COM1)
5*	13	
6	14	Floppy Disk Controller
7*	15	Printer Port (LPT1)
8	3	System CMOS/Real Time Clock
9*	4	ACPI Mode when enabled
10*	5	IRQ Holder for PCI Steering
11*	6	IRQ Holder for PCI Steering
12*	7	PS/2 Compatible Mouse Port
13	8	Numeric Data Processor
14*	9	Primary IDE Channel
15*	10	Secondary IDE Channel

\*These IRQs are usually available for ISA or PCI devices.

# 3. HARDWARE SETUP

*Interrupt Request Table*

	INT-A	INT-B	INT-C	INT-D
PCI slot 1	shared	--	--	--
PCI slot 2	--	shared	--	--
PCI slot 3	--	--	shared	--
PCI slot 4	--	--	--	shared
PCI slot 5	shared	--	--	--
PCI slot 6	--	--	shared	--
Onboard VGA	shared	----	--	--
Onboard audio/AMR/SMBus	--	shared	--	--
Onboard LAN	--	--	shared	--
USB	--	--	--	shared

**IMPORTANT:** If using PCI cards on shared slots, make sure that the drivers support “Share IRQ” or that the cards do not need IRQ assignments. Conflicts will arise between the two PCI groups that will make the system unstable or cards inoperable.

Both ISA and PCI expansion cards may require IRQs. System IRQs are available to cards installed in the ISA expansion bus first, then any remaining IRQs are available to PCI cards. Currently, there are two types of ISA cards.

The original ISA expansion card design, now referred to as “Legacy” ISA cards, requires that you configure the card’s jumpers manually and then install it in any available slot on the ISA bus. To see a map of your used and free IRQs in Windows 98, the **Control Panel** icon in **My Computer**, contains a **System** icon, which gives you a **Device Manager** tab. Double-clicking on a specific hardware device gives you the **Resources** tab which shows the Interrupt number and address. Double-click **Computer** to see all the interrupts and addresses for your system. Make sure that no two devices use the same IRQ or your computer will experience problems when those two devices are in use at the same time.

To simplify this process, this motherboard complies with the Plug and Play (PnP) specification which was developed to allow automatic system configuration whenever a PnP-compliant card is added to the system. For PnP cards, IRQs are assigned automatically from those available.

If the system has both Legacy and PnP ISA cards installed, IRQs are assigned to PNP cards from those not used by Legacy cards. The PCI and PNP configuration of the BIOS setup utility can be used to indicate which IRQs are being used by Legacy cards. For older Legacy cards that does not work with the BIOS, you can contact your vendor for an ISA Configuration Utility.

An IRQ number is automatically assigned to PCI expansion cards after those used by Legacy and PnP ISA cards. In the PCI bus design, the BIOS automatically assigns an IRQ to a PCI slot that has a card in it that requires an IRQ. To install a PCI card, you need to set something called the INT (interrupt) assignment. Since all the PCI slots on this motherboard use an INTA #, be sure that the jumpers on your PCI cards are set to INT A.

# 3. HARDWARE SETUP

## 3.7.3 Assigning DMA Channels for ISA Cards

Some ISA cards, both legacy and PnP, may also need to use a DMA (Direct Memory Access) channel. DMA assignments for this motherboard are handled the same way as the IRQ assignment process described earlier. To select a DMA channel, see **PCI/PNP ISA DMA Resource Exclusion** in *4.4.3 PCI Configuration*. **NOTE:** The on-board audio by default uses DMA1.

**IMPORTANT:** To avoid conflicts, reserve the necessary IRQs and DMAs for legacy ISA cards (see **PCI/PNP ISA IRQ Resource Exclusion** in *4.4.3 PCI Configuration*). Choose *Yes* in **IRQ xx Used By ISA** and **DMA x Used By ISA** for those IRQs and DMAs you want to reserve).

## 3.7.4 Audio Modem Riser (AMR) Slot

This connector supports a specially designed audio and/or modem card called an AMR. Main processing is done through software and controlled by the motherboard's Intel I/O Controller Hub (ICH). This provides an upgradeable audio and/or modem solution at an incredibly low cost. There are two types of AMR, one defined as primary and another defined as secondary. This motherboard uses the primary channel so that a secondary AMR can coexist without the need to disable the onboard CODEC. The motherboard's onboard CODEC must be disabled when using a primary AMR.

**NOTE:** An AMR is not included with this motherboard.

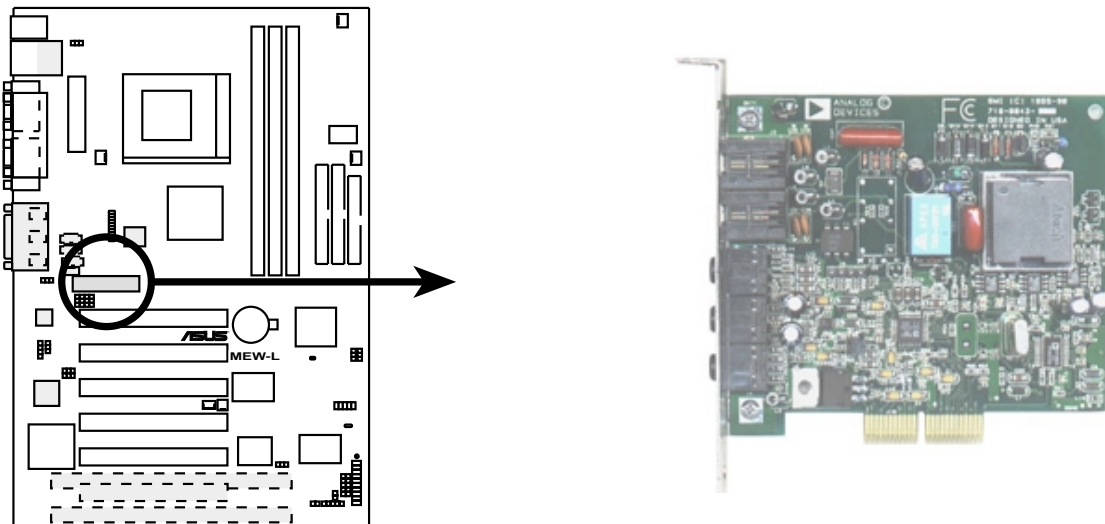

**MEW-L Audio Modem Riser (AMR) Connector**

# 3. HARDWARE SETUP

## 3.8 External Connectors

**WARNING!** Some pins are used for connectors or power sources. These are clearly distinguished from jumpers in the Motherboard Layout. Placing jumper caps over these connector pins will cause damage to your motherboard.

**IMPORTANT:** Ribbon cables should always be connected with the red stripe to Pin 1 on the connectors. Pin 1 is usually on the side closest to the power connector on hard drives and CD-ROM drives, but may be on the opposite side on floppy disk drives. Check the connectors before installation because there may be exceptions. IDE ribbon cables must be less than 46 cm (18 in.), with the second drive connector no more than 15 cm (6 in.) from the first connector.

**NOTE:** Onboard Fast-Ethernet is optional at the time of purchase. The illustrations below are that of the model without the onboard Fast-Ethernet.

### 1) PS/2 Mouse Connector (Green 6-pin PS2KBMS)

The system will direct IRQ12 to the PS/2 mouse if one is detected. If one is not detected, expansion cards can use IRQ12. See **PS/2 Mouse Function Control** in *4.4 Advanced Menu*.

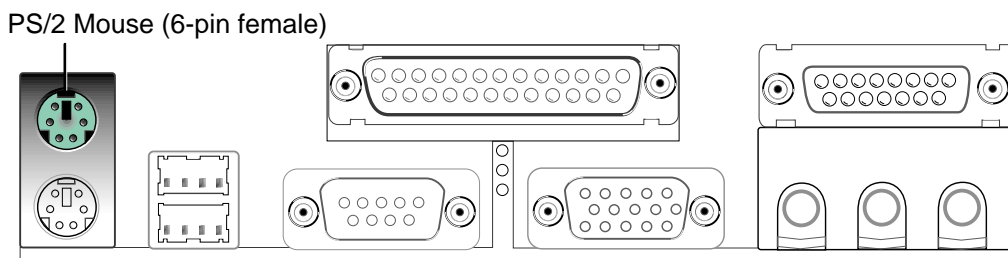

### 2) PS/2 Keyboard Connector (Purple 6-pin PS2KBMS)

This connection is for a standard keyboard using an PS/2 plug (mini DIN). **This connector will not allow standard AT size (large DIN) keyboard plugs. You may use a DIN to mini DIN adapter on standard AT keyboards.**

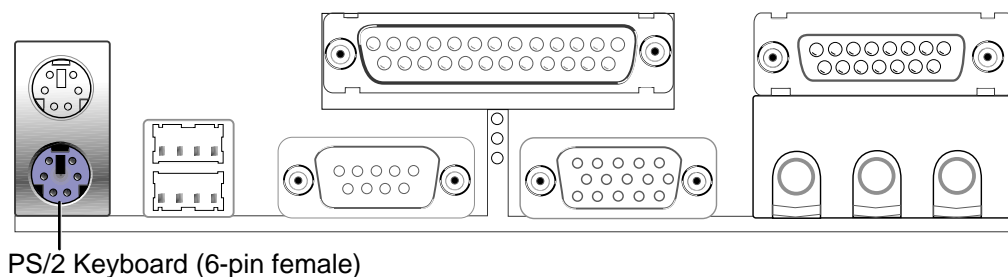



# 3. HARDWARE SETUP

## 3) Universal Serial Bus Ports 1 & 2 (Two black 4-pin USB)

Two USB ports are available for connecting USB devices.

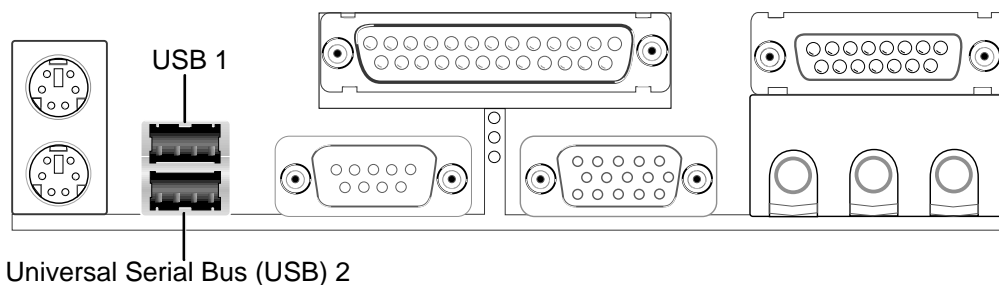

## 4) Parallel Port Connector (Burgundy 25-pin PRINTER)

You can enable the parallel port and choose the IRQ through **Onboard Parallel Port** (see **4.4.2 I/O Device Configuration**).

**NOTE:** Serial printers must be connected to the serial port.

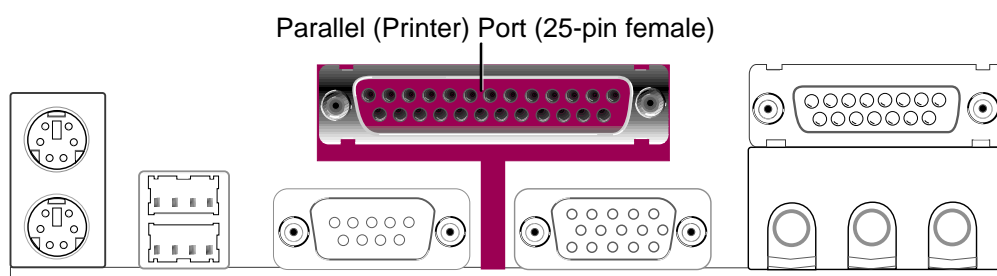

## 5) Serial Port COM1 Connector (Teal/Turquoise 9-pin COM1)

One serial port is ready for a mouse or other serial devices. A second serial port is available using a serial port bracket connected from the motherboard to an expansion slot opening. See **Onboard Serial Port 1** in **4.2.2 I/O Device Configuration** for settings.

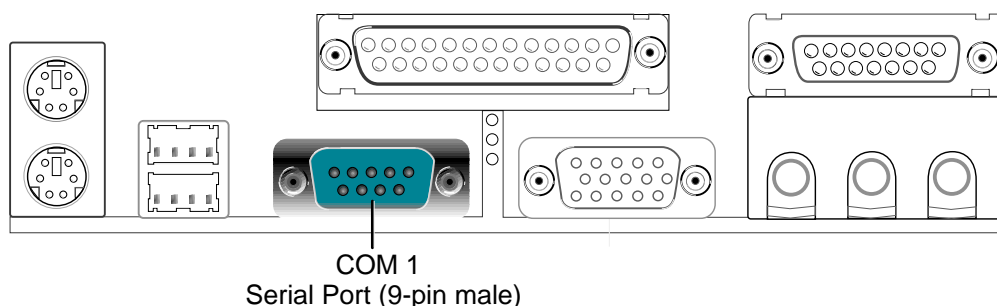



# 3. HARDWARE SETUP

## 6) Monitor Output Connector (Blue 15-pin VGA)

This connector is for output to a VGA-compatible device.

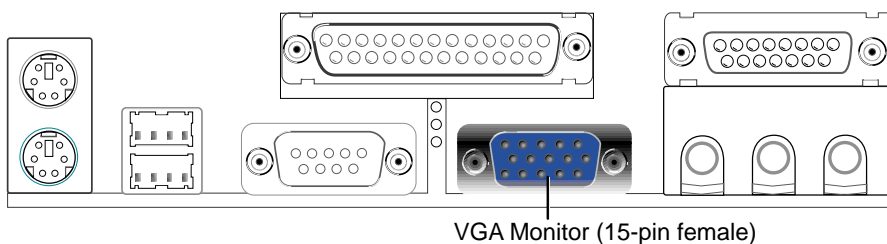

## 7) Joystick/MIDI Connector (Gold 15-pin GAME\_AUDIO) (optional)

You may connect game joysticks or game pads to this connector for playing games. Connect MIDI devices for playing or editing professional audio.

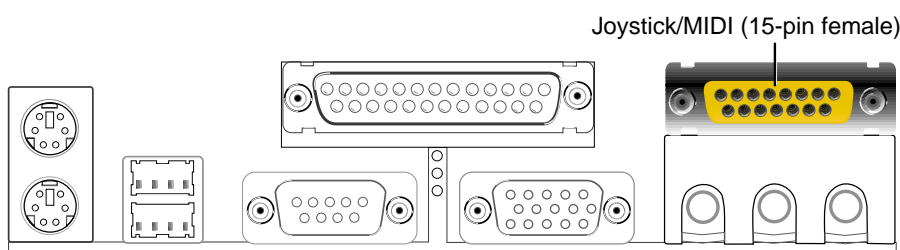

**NOTE:** The onboard game port is to be used only if you are not using any PCI or ISA audio card with a game port.

## 8) Audio Port Connectors (Three 1/8" GAME\_AUDIO) (optional)

**Line Out** (lime) can be connected to headphones or preferably powered speakers. **Line In** (light blue) allows tape players or other audio sources to be recorded by your computer or played through the **Line Out** (lime). **Mic** (pink) allows microphones to be connected for inputting voice.

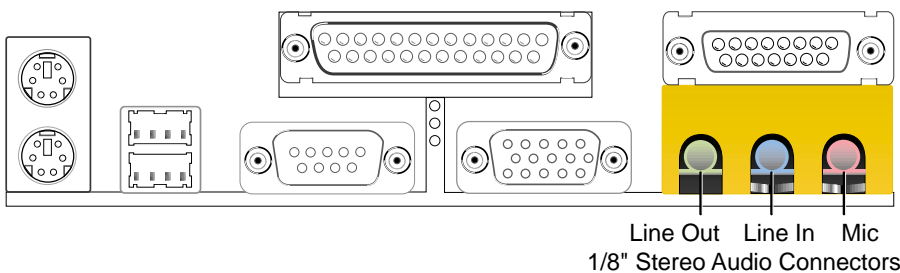

## 9) Fast-Ethernet Port Connector (RJ45) (optional)

The RJ45 connector is optional at the time of purchase and is located on top of the USB connectors. The connector allows the motherboard to connect to a Local Area Network (LAN) through a network hub.

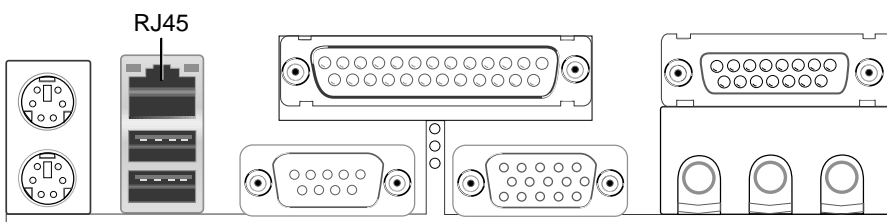

# 3. HARDWARE SETUP

## 10) Primary / Secondary IDE Connectors (Two 40-1 pin IDE)

These connectors support the provided IDE hard disk ribbon cable. After connecting the single end to the board, connect the two plugs at the other end to your hard disk(s). If you install two hard disks, you must configure the second drive to Slave mode by setting its jumper accordingly. Please refer to your hard disk documentation for the jumper settings. BIOS now supports specific device bootup (see **Boot Sequence** in *4.6 Boot Menu*). **(Pin 20 is removed to prevent inserting in the wrong orientation when using ribbon cables with pin 20 plugged).**

**TIP:** You may configure two hard disks to be both Masters with two ribbon cables – one for the primary IDE connector and another for the secondary IDE connector. You may install one operating system on an IDE drive and another on a SCSI drive and select the boot disk through **Boot Sequence** in *4.6 Boot Menu*. **IMPORTANT: UltraDMA/66 IDE devices must use an 80-conductor IDE cable.**

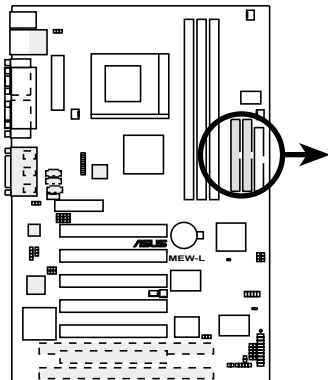

MEW-L IDE Connectors

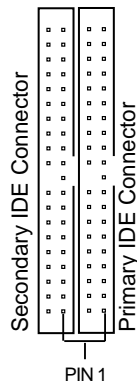

**NOTE:** Orient the red markings (usually zigzag) on the IDE ribbon cable to PIN 1

## 11) Floppy Disk Drive Connector (34-1 pin FLOPPY)

This connector supports the provided floppy drive ribbon cable. After connecting the single end to the board, connect the two plugs on the other end to the floppy drives. **(Pin 5 is removed to prevent inserting in the wrong orientation when using ribbon cables with pin 5 plugged).**

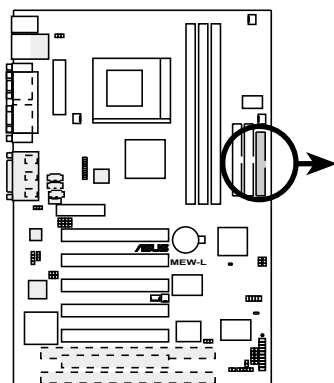

MEW-L Floppy Disk Drive Connector

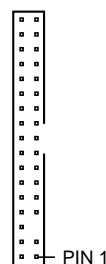

**NOTE:** Orient the red markings on the floppy ribbon cable to PIN 1

# 3. HARDWARE SETUP

## 12) Wake-On-LAN Connector (3-pin WOL\_CON)

This connector connects to a LAN card with a Wake-On-LAN output, such as the ASUS PCI-L101 Ethernet card (not required for onboard LAN model). The connector powers up the system when a wakeup packet or signal is received through the LAN card.

**IMPORTANT:** This feature requires that **Wake On LAN** is set to *Enabled* (see **4.5.1 Power Up Control**) and that your system has an ATX power supply with at least 720mA +5V standby power.

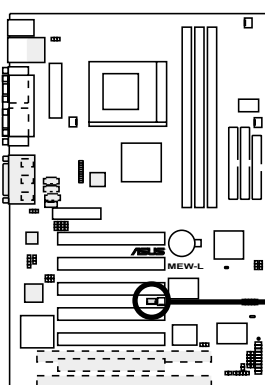

**IMPORTANT:** Requires an ATX power supply with at least 720mA +5 volt standby power

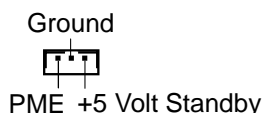

**MEW-L Wake-On-LAN Connector**

## 13) Wake-On-Ring Connector (2-pin WOR)

This connector connects to internal modem cards with a Wake-On-Ring output. The connector powers up the system when a ringup packet or signal is received through the internal modem card. **NOTE:** For external modems, Wake-On-Ring is detected through the COM port.

**IMPORTANT:** This feature requires that **PWR Up On Modem Act** is set to *Enabled* (see **4.5.1 Power Up Control**) and that your system has an ATX power supply with at least 720mA +5V standby power.

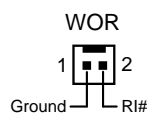
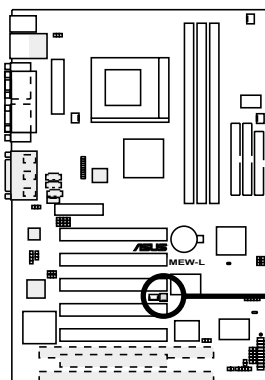

**MEW-L Wake-On-Ring Connector**

# 3. HARDWARE SETUP

## 14) IDE Activity LED Lead (2-pin IDELED)

This lead supplies power to the cabinet's IDE activity LED. Read and write activity by devices connected to the Primary or Secondary IDE connectors will cause the LED to light up.

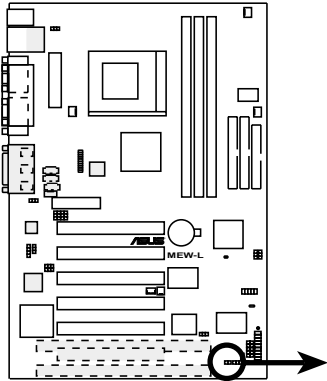

**MEW-L IDE Activity LED**

**TIP:** If the case-mounted LED does not light, try reversing the 2-pin plug.



## 15) Chassis, CPU, & Power Supply Fan Connectors (3-pin CHA\_, CPU\_, PWR\_FAN)

These connectors support cooling fans of 350mA (4.2 Watts) or less. Orientate the fans so that the heat sink fins allow airflow to go across the onboard heat sink(s) instead of the expansion slots. Depending on the fan manufacturer, the wiring and plug may be different. The red wire should be positive, while the black should be ground. Connect the fan's plug to the board taking into consideration the polarity of the connector.

**NOTE:** The "Rotation" signal is to be used only by a specially designed fan with rotation signal. The Rotations per Minute (RPM) can be monitored using ASUS PC Probe Utility or Intel LDCM Utility (see section 6. SOFTWARE REFERENCE).

**WARNING!** The CPU and/or motherboard will overheat if there is no airflow across the CPU and onboard heatsinks. Damage may occur to the motherboard and/or the CPU fan if these pins are incorrectly used. **These are not jumpers, do not place jumper caps over these pins.**

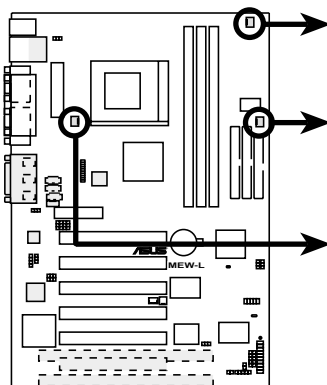

**MEW-L 12-Volt Cooling Fan Power**

CPU Fan Power



Chassis Fan Power

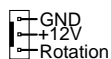

Power Supply Fan

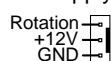

# 3. HARDWARE SETUP

## 16) Internal Audio Connectors (4-pin VIDEO, AUX, CD, TAD)

These connectors allow you to receive stereo audio input from such sound sources as a CD-ROM, TV tuner, or MPEG card. The TAD connector allows the on-board audio to interface with a voice modem card with a similar connector. It also allows the sharing of mono\_in (such as a phone) and mono\_out (such as a speaker) between the onboard audio and the voice modem card.

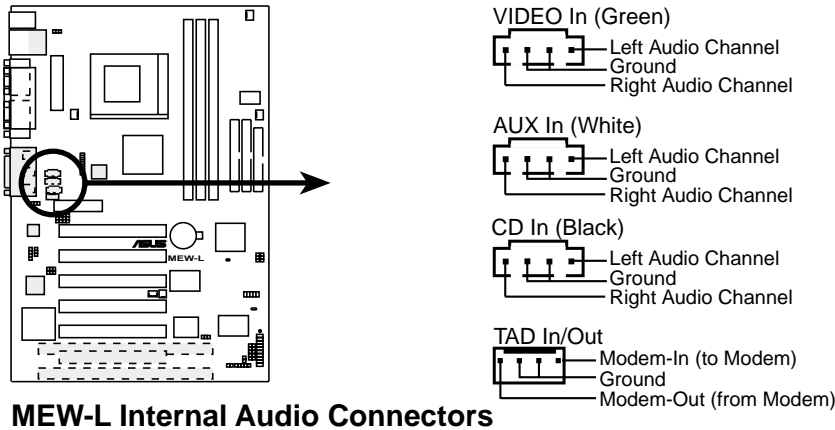

## 17) Internal Speaker Connector (SPKEAR)

This connector allows you to connect the internal chassis speaker to the onboard audio's output. This will allow you to use the chassis' built-in speaker to listen to sounds normally requiring separately purchased external speakers. The ground (GND) wire is usually the black wire and the speaker-out (SPKOUT) is usually the red wire. System beeps and warnings sent through the chassis speaker connector is also routed through this internal speaker connector so that there is no need for two speakers.

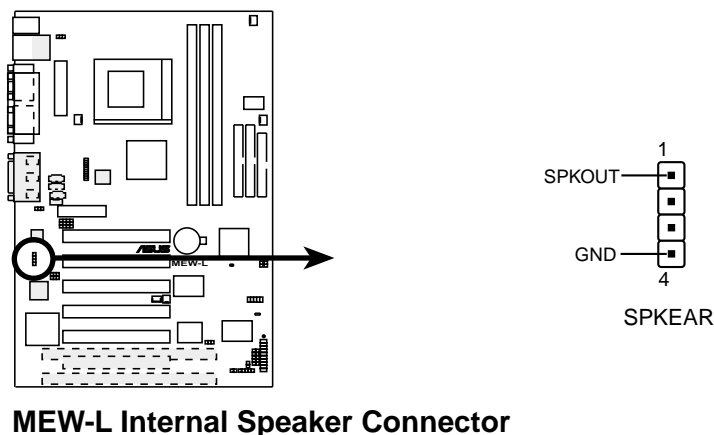

3. HW SETUP  
Connectors

# 3. HARDWARE SETUP

## 18) Standard IR (SIR) (5-pin) and Consumer IR (CIR) (5-1 pin) Connectors

This connector supports an optional wireless transmitting and receiving infrared module. This module mounts to a small opening on system cases that support this feature. You must also configure the setting through **UART2 Use Infrared** (see **4.4.2 I/O Device Configuration**) to select whether UART2 is directed for use with COM2 or IrDA. Use the five pins as shown in Back View and connect a ribbon cable from the module to the motherboard's SIR connector according to the pin definitions. An optional consumer infrared (CIR) set connects to the CIR and SIR connectors simultaneously for both wireless transmitting and remote control functions through one external infrared module. **Wake On PS2 KB/Mouse** in **4.5.1 Power Up Control** must be Enabled in order to use Consumer Infrared (CIR) power up.

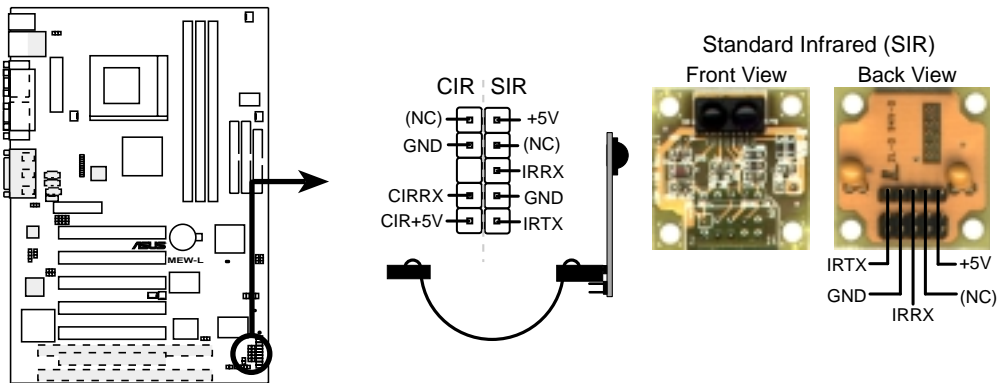

**MEW-L Infrared Module Connector**

## 19) Serial Port COM 2 Header (10-1 pin COM2)

The optional serial port bracket can be used to add an additional serial port for a second serial device. The connector with bracket shown here is for the non-LCD model.

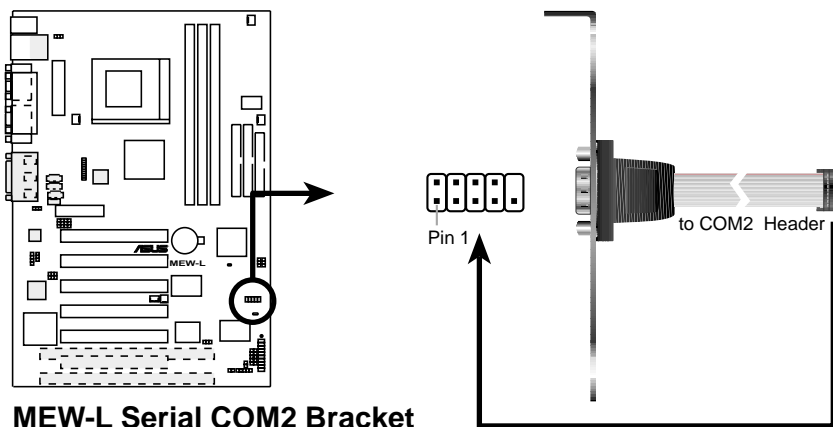

**MEW-L Serial COM2 Bracket**

# 3. HARDWARE SETUP

## 20) SMBus Connector (5-1 pin SMB)

This connector allows you to connect SMBus (System Management Bus) devices. SMBus devices communicate by means of the SMBus with an SMBus host and/or other SMBus devices. SMBus is a specific implementation of an I<sup>2</sup>C bus, which is a multi-device bus; that is, multiple chips can be connected to the same bus and each one can act as a master by initiating data transfer.

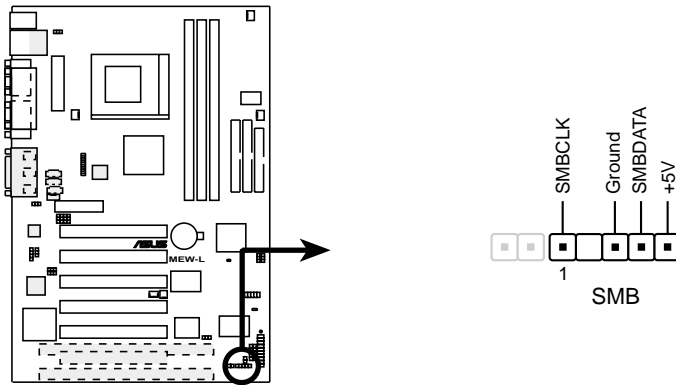

MEW-L SMBus Connector

## 21) Digital LCD Header (20-1 pin DFP) (optional)

This header requires a digital LCD cable connector. For the LCD model, the individual serial cable with bracket is replaced with the LCD and serial combination cable with bracket (as shown here). Connect the digital LCD cable to the LCD header and the serial cable to the COM2 header and mount the bracket to the chassis on a free expansion slot. **NOTE:** If both CRT and digital LCD monitors are used, the CRT will take precedent. This connector is for a digital LCD panel; an analog LCD panel comes with a 15-pin VGA cable connector to be used on the monitor connector. The connectors with bracket shown here are provided with the LCD model.

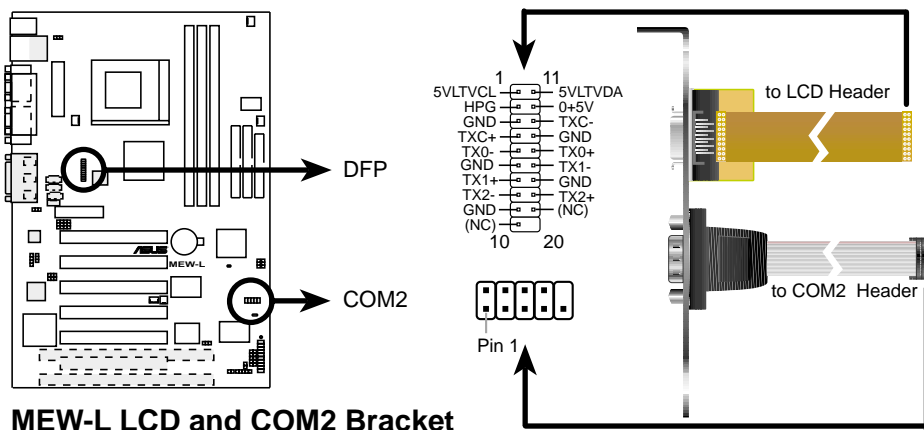

MEW-L LCD and COM2 Bracket

# 3. HARDWARE SETUP

## 22) Internal Microphone Connector (3 pin INT MIC)

This connector allows you to connect a chassis mounted microphone to the motherboard instead of having to attach an external microphone.

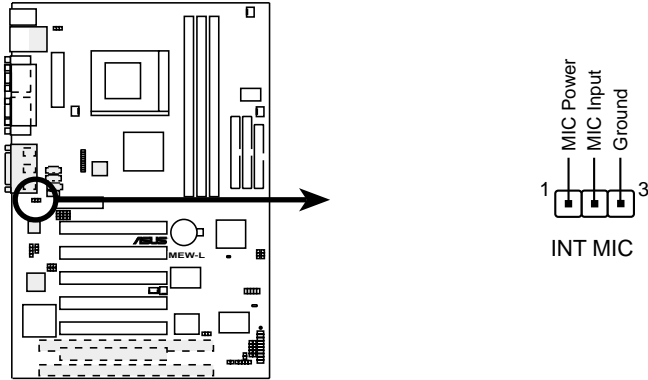

**MEW-L Internal Microphone Connector**



# 3. HARDWARE SETUP

## 23. Chassis Intrusion Lead (2-pin CHA)

This lead is for a chassis designed for chassis intrusion detection. After-market toggle switches may also be installed to the chassis panel or on any removable components. Two wires should be available from the chassis to connect to this lead. When any chassis component is removed, the contact should open and the motherboard will record a chassis intrusion event. If the chassis intrusion connector is not used, a jumper cap must be placed over the pins to prevent unnecessary power loss.

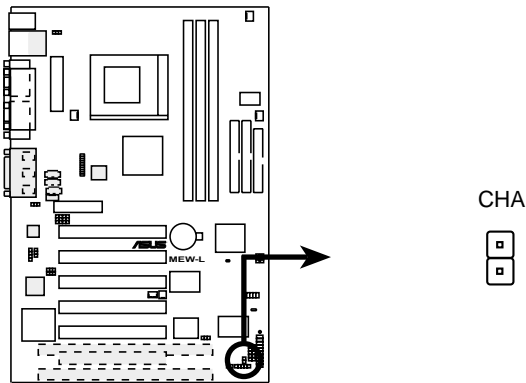

**MEW-L Chassis Open Alarm Lead**

## 24) ATX Power Supply Connector (20-pin block ATXPWR)

This connector connects to an ATX power supply. The plug from the power supply will only insert in one orientation because of the different hole sizes. Find the proper orientation and push down firmly making sure that the pins are aligned.

**IMPORTANT:** Make sure that your ATX power supply can supply at least 10mA on the +5-volt standby lead (+5VSB). You may experience difficulty in powering ON your system if your power supply cannot support the load. For Wake-On-LAN support, your ATX power supply must supply at least 720mA +5VSB.

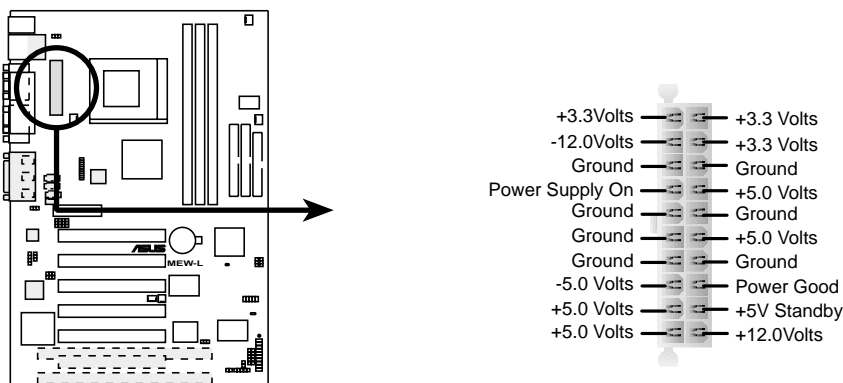

**MEW-L ATX Power Connector**

# 3. HARDWARE SETUP

The following PANEL illustration is used for items 25-31

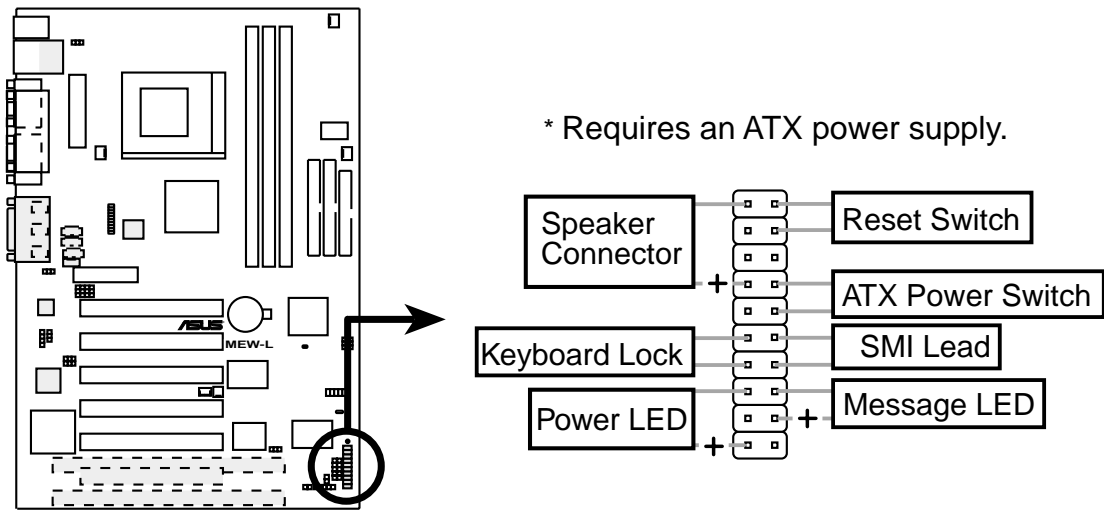

**MEW-L System Panel Connectors**

3. HW/SETUP  
Connectors

## 3. HARDWARE SETUP

---

### 25) System Warning Speaker Connector (4-pin SPEAKER)

This 4-pin connector connects to the case-mounted speaker. You may leave this disconnected if you connect the chassis speaker to the internal speaker connector. All three sources (LINE\_OUT, INT\_SPKA, SPEAKER) will allow you to hear system beeps and warnings. Only LINE\_OUT will allow you to hear system beeps before the integrated audio has been properly initialized.

### 26) Keyboard Lock Switch Lead (2-pin KEYLOCK)

This 2-pin connector connects to the case-mounted key switch to allow keyboard locking.

### 27) System Power LED Lead (3-1 pin PLED)

This 3-1 pin connector connects the system power LED, which lights when the system is powered on and blinks when it is in sleep mode.

### 28) Reset Switch Lead (2-pin RESET)

This 2-pin connector connects to the case-mounted reset switch for rebooting your computer without having to turn off your power switch. This is a preferred method of rebooting to prolong the life of the system's power supply.

### 29) ATX Power Switch Lead (2-pin PWRSW)

The system power is controlled by a momentary switch connected to this lead. Pressing the button once will switch the system between ON and SOFT OFF. Pushing the switch while in the ON mode for more than 4 seconds will turn the system off. The system power LED shows the status of the system's power.

### 30) System Management Interrupt Lead (2-pin SMI)

This allows the user to manually place the system into a suspend mode or "Green" mode, where system activity is decreased to save electricity and expand the life of certain components when the system is not in use. This 2-pin connector connects to the case-mounted suspend switch. If you do not have a switch for the connector, you may use the "Turbo Switch." SMI is activated when it detects a *short to open* moment and therefore leaving it shorted will not cause any problems. This may require one or two presses depending on the position of the switch. Wake-up can be controlled by settings in the BIOS but the keyboard will always allow wake-up (the SMI lead cannot wake up the system).

### 31) Message LED Lead (2-pin LED)

This indicates whether a message has been received from a fax/modem. The LED will remain lit when there is no signal and blink when there is data transfer or waiting in the inbox. This function requires ACPI OS and driver support.

# 3. HARDWARE SETUP

---

(This page was intentionally left blank)

## 3. HARDWARE SETUP

---

### 3.9 Power Connection Procedures

1. After all connections are made, close the system case cover.
  2. Be sure that all switches are OFF (in some systems, marked with ○).
  3. Connect the power supply cord into the power supply located on the back of your system case according to your system user's manual.
  4. Connect the power cord into a power outlet that is equipped with a surge protector.
  5. You may then turn ON your devices in the following order:
    - a. Your monitor
    - b. External SCSI devices (starting with the last device on the chain)
    - c. Your system power. For ATX power supplies, you need to switch ON the power supply as well as press the ATX power switch on the front of the case.
  6. The power LED on the front panel of the system case will light. For ATX power supplies, the system LED will light when the ATX power switch is pressed. The LED on the monitor may light up or switch between orange and green after the system's if it complies with "green" standards or if it has a power standby feature. The system will then run power-ON tests. While the tests are running, additional messages will appear on the screen. If you do not see anything within 30 seconds from the time you turn ON the power, the system may have failed a power-ON test. Recheck your jumper settings and connections or call your retailer for assistance.
  7. During power-ON, hold down <Delete> to enter BIOS setup. Follow the instructions in **4. BIOS SETUP**.
- \* **Powering Off your computer:** You must first exit or shut down your operating system before switching OFF the power switch. For ATX power supplies, you can press the ATX power switch after exiting or shutting down your operating system. If you are using Windows 95/98, click the **Start** button, click **Shut Down**, and then click **Shut down the computer?** The power supply should turn OFF after Windows shuts down.
- NOTE:** The message "You can now safely turn off your computer" will not appear when shutting down with ATX power supplies.

# 4. BIOS SETUP

## 4.1 Managing and Updating Your BIOS

### 4.1.1 Upon First Use of the Computer System

It is recommended that you save a copy of the original motherboard BIOS along with a Flash Memory Writer utility (AFLASH.EXE) to a bootable floppy disk in case you need to reinstall the BIOS later. **AFLASH.EXE** is a Flash Memory Writer utility that updates the BIOS by uploading a new BIOS file to the programmable flash ROM on the motherboard. This file works only in DOS mode. To determine the BIOS version of your motherboard, check the last four numbers of the code displayed on the upper left-hand corner of your screen during bootup. Larger numbers represent a newer BIOS file.

1. Type **FORMAT A:/S** at the DOS prompt to create a bootable system floppy disk. **DO NOT** copy AUTOEXEC.BAT & CONFIG.SYS to the disk.
2. Type **COPY D:\AFLASH\AFLASH.EXE A:\** (assuming D is your CD-ROM drive) to copy AFLASH.EXE to the just created boot disk.

**NOTE:** AFLASH works only in DOS mode. It will not work with DOS prompt in Windows and will not work with certain memory drivers that may be loaded when you boot from your hard drive. It is recommended that you reboot using a floppy.

3. Reboot your computer from the floppy disk. **NOTE:** BIOS setup must specify “Floppy” as the first item in the boot sequence.
4. In DOS mode, type **A:\AFLASH <Enter>** to run AFLASH.

```
ASUS ACPI BIOS
FLASH MEMORY WRITER V1.28
Copyright (C) 1994-99, ASUSTeK COMPUTER INC.

Flash Memory: Winbond W29C028 or SST 29EE028 or Intel 02802AB

Current BIOS Version: ASUS XXX-XX ACPI BIOS Revision 100X
BIOS Model           : XXX-XX
BIOS Built Date      : 89/25/98

Choose one of the following:

1. Save Current BIOS To File
2. Update BIOS Including Boot Block and ESCD

Enter choice: [1]

Press ESC To Exit
```

**IMPORTANT!** If “unknown” is displayed after **Flash Memory:**, the memory chip is either not programmable or is not supported by the ACPI BIOS and therefore, cannot be programmed by the Flash Memory Writer utility.

# 4. BIOS SETUP

5. Select **1. Save Current BIOS to File** from the Main menu and press <Enter>. The **Save Current BIOS To File** screen appears.

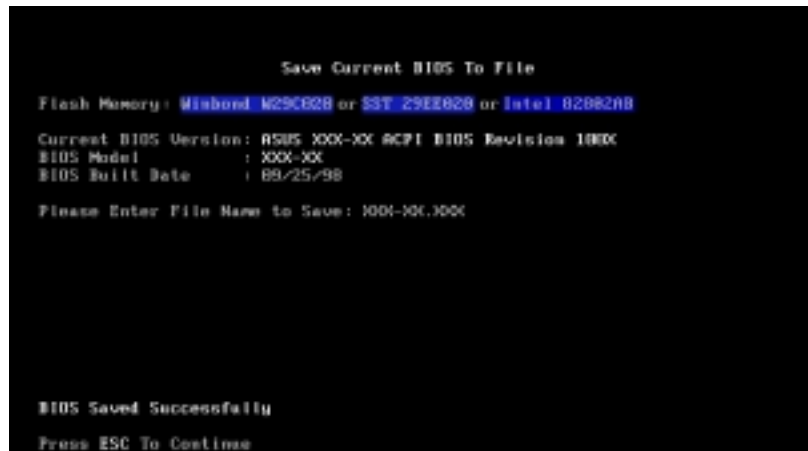

6. Type a filename and the path, for example, **A:\XXX-XX.XXX** and then press <Enter>.

## 4.1.2 Updating BIOS Procedures

**WARNING!** Only update your BIOS if you have problems with your motherboard and you know that the new BIOS revision will solve your problems. Careless updating can result in your motherboard having more problems!

1. Download an updated ASUS BIOS file from the Internet (WWW or FTP) (see ASUS CONTACT INFORMATION on page 3 for details) and save to the disk you created earlier.
2. Boot from the disk you created earlier.
3. At the “A:\” prompt, type **AFLASH** and then press <Enter>.
4. At the **Main Menu**, type **2** and then press <Enter>. The **Update BIOS Including Boot Block and ESCD** screen appears.
5. Type the filename of your new BIOS and the path, for example, **A:\XXX-XX.XXX**, and then press <Enter>.

**NOTE:** To cancel this operation, press <Enter>.



# 4. BIOS SETUP

6. When prompted to confirm the BIOS update, press **Y** to start the update.

```
Update BIOS Including Boot Block and ESCD
Flash Memory: Winbond M25C02B or SST 25C02B or Intel B25R24B

BIOS Version
(CURRENT) ASUS 1001-XX ACPI BIOS Revision 100X
(Flash) ASUS 1001-XX ACPI BIOS Revision 100X

BIOS Model
(CURRENT) XXX-XX
(Flash) XXX-XX

Date of BIOS Build
(CURRENT) 05/25/08
(Flash) 05/25/08

Notice: Boot Block is different. Check sum of 1001.010 is F25E.

Are you sure (Y/N) Y [Y]

Press ESC To Return to Main Menu
```

7. The utility starts to program the new BIOS information into the flash ROM. The boot block will be updated automatically only when necessary. This will minimize the chance that a failed update will prevent your system from booting up. When the programming is finished, *Flashed Successfully* will be displayed.

```
Update BIOS Including Boot Block and ESCD
Flash Memory: Winbond M25C02B or SST 25C02B or Intel B25R24B

BIOS Version
(CURRENT) ASUS 1001-XX ACPI BIOS Revision 100X
(Flash) ASUS 1001-XX ACPI BIOS Revision 100X

BIOS Model
(CURRENT) XXX-XX
(Flash) XXX-XX

Date of BIOS Build
(CURRENT) 05/25/08
(Flash) 05/25/08

Notice: Boot Block is different. Check sum of 1001.010 is F25E.

Are you sure (Y/N) Y [Y]
Block Erasing -- Done
Programming -- 3FFFF
Flashed Successfully

Press ESC To Continue
```

8. Follow the onscreen instructions to continue.

```
ASUS ACPI BIOS
FLASH MEMORY WRITER V1.20
Copyright (C) 1994-01, ASUSTeK COMPUTER INC.

Flash Memory: Winbond M25C02B or SST 25C02B or Intel B25R24B

Current BIOS Version: ASUS 1001-XX ACPI BIOS Revision 100X
BIOS Model : XXX-XX
BIOS Build Date : 05/25/08

Choose one of the following:
1. Save Current BIOS To File
2. Update BIOS Including Boot Block and ESCD

Enter choice: 11

You have flashed the EPROM. It is recommended that you turn off
the power, enter SETUP and Load Setup Defaults to have CMOS
updated with new BIOS when exits.

Press ESC To Exit.
```

**WARNING!** If you encounter problems while updating the new BIOS, DO NOT turn OFF your system since this might prevent your system from booting up. Just repeat the process, and if the problem still persists, update the original BIOS file you saved to disk above. If the Flash Memory Writer utility was not able to successfully update the BIOS file, your system may not be able to boot up. If this happens, your system will need servicing.



# 4. BIOS SETUP

---

## 4.2 BIOS Setup Program

This motherboard supports a programmable EEPROM that can be updated using the provided utility as described in *4.1 Managing and Updating Your BIOS*.

The utility is used if you are installing a motherboard, reconfiguring your system, or prompted to “**Run Setup**”. This section describes how to configure your system using this utility.

Even if you are not prompted to use the Setup program, at some time in the future you may want to change the configuration of your computer. For example, you may want to enable the Security Password Feature or make changes to the power management settings. It will then be necessary to reconfigure your system using the BIOS Setup program so that the computer can recognize these changes and record them in the CMOS RAM of the EEPROM.

The EEPROM on the motherboard stores the Setup utility. When you start up the computer, the system provides you with the opportunity to run this program. This appears during the Power-On Self Test (POST). Press <Delete> to call up the Setup utility. If you are a little bit late in pressing the mentioned key, POST will continue with its test routines, thus preventing you from calling up Setup. If you still need to call Setup, restart the system by pressing <Ctrl> + <Alt> + <Delete>, or by pressing the Reset button on the system chassis. You can also restart by turning the system OFF and then back ON again. But do so only if the first two methods fail.

The Setup program has been designed to make it as easy to use as possible. It is a menu-driven program, which means you can scroll through the various sub-menus and make your selections among the predetermined choices.

**To access the BIOS Setup program, press the <Delete> key after the computer has run through its POST.**

**NOTE:** Because the BIOS software is constantly being updated, the following BIOS screens and descriptions are for reference purposes only and may not reflect your BIOS screens exactly.

# 4. BIOS SETUP

---

## 4.2.1 BIOS Menu Bar

The top of the screen has a menu bar with the following selections:

- MAIN** Use this menu to make changes to the basic system configuration.
- ADVANCED** Use this menu to enable and make changes to the advanced features.
- POWER** Use this menu to configure and enable Power Management features.
- BOOT** Use this menu to configure the default system device used to locate and load the Operating System.
- EXIT** Use this menu to exit the current menu or specify how to exit the Setup program.

To access the menu bar items, press the right or left arrow key on the keyboard until the desired item is highlighted.

## 4.2.2 Legend Bar

At the bottom of the Setup screen you will notice a legend bar. The keys in the legend bar allow you to navigate through the various setup menus. The following table lists the keys found in the legend bar with their corresponding alternates and functions.

<b>Navigation Key(s)</b>	<b>Function Description</b>
<F1> or <Alt + H>	Displays the General Help screen from anywhere in the BIOS Setup
<Esc>	Jumps to the Exit menu or returns to the main menu from a sub-menu
← or → (keypad arrow)	Selects the menu item to the left or right
↑ or ↓ (keypad arrow)	Moves the highlight up or down between fields
- (minus key)	Scrolls backward through the values for the highlighted field
+ (plus key) or spacebar	Scrolls forward through the values for the highlighted field
<Enter>	Brings up a selection menu for the highlighted field
<Home> or <PgUp>	Moves the cursor to the first field
<End> or <PgDn>	Moves the cursor to the last field
<F5>	Resets the current screen to its Setup Defaults
<F10>	Saves changes and exits Setup

# 4. BIOS SETUP

---

## General Help

In addition to the Item Specific Help window, the BIOS setup program also provides a General Help screen. This screen can be called up from any menu by simply pressing <F1> or the <Alt> + <H> combination. The General Help screen lists the legend keys with their corresponding alternates and functions.

## Saving Changes and Exiting the Setup Program

See *4.7 Exit Menu* for detailed information on saving changes and exiting the setup program.

## Scroll Bar

When a scroll bar appears to the right of a help window, it indicates that there is more information to be displayed that will not fit in the window. Use <PgUp> and <PgDn> or the up and down arrow keys to scroll through the entire help document. Press <Home> to display the first page, press <End> to go to the last page. To exit the help window, press <Enter> or <Esc>.

## Sub-Menu

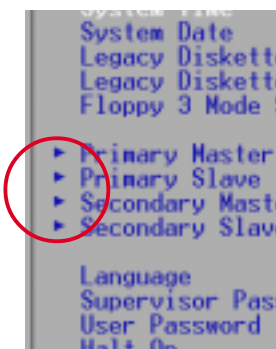

Note that a right pointer symbol (as shown in the left view) appears to the left of certain fields. This pointer indicates that a sub-menu can be launched from this field. A sub-menu contains additional options for a field parameter. To call up a sub-menu, simply move the highlight to the field and press <Enter>. The sub-menu will then immediately appear. Use the legend keys to enter values and move from field to field within a sub-menu just as you would within a menu. Use the <Esc> key to return to the main menu.

Take some time to familiarize yourself with each of the legend keys and their corresponding functions. Practice navigating through the various menus and sub-menus. If you accidentally make unwanted changes to any of the fields, use the set default hot key <F5>. While moving around through the Setup program, note that explanations appear in the Item Specific Help window located to the right of each menu. This window displays the help text for the currently highlighted field.

**NOTE:** The item heading in square brackets represents the default setting for that field.

# 4. BIOS SETUP

## 4.3 Main Menu

When the Setup program is accessed, the following screen appears:

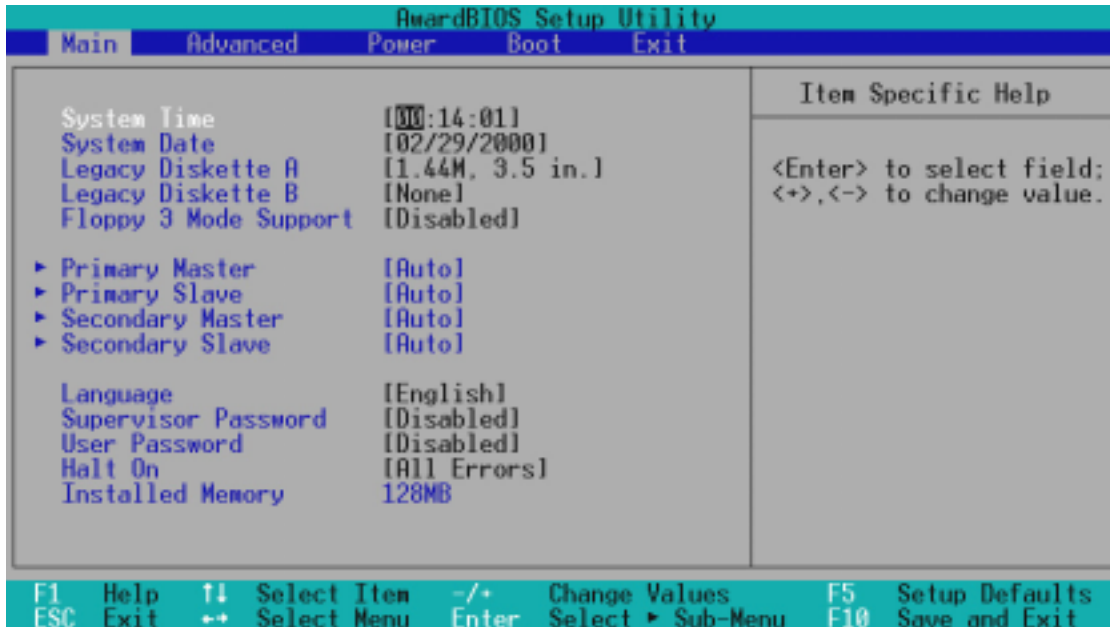

### System Time [XX:XX:XX]

Sets your system to the time that you specify (usually the current time). The format is hour, minute, second. Valid values for hour, minute and second are **Hour: (00 to 23)**, **Minute: (00 to 59)**, **Second: (00 to 59)**. Use the <Tab> or <Shift> + <Tab> keys to move between the hour, minute, and second fields.

### System Date [XX/XX/XXXX]

Sets your system to the date that you specify (usually the current date). The format is month, day, year. Valid values for month, day, and year are **Month: (1 to 12)**, **Day: (1 to 31)**, **Year: (100 year range)**. Use the <Tab> or <Shift> + <Tab> keys to move between the month, day, and year fields.

### Legacy Diskette A [1.44M, 3.5 in.], Legacy Diskette B [None]

Sets the type of floppy drives installed. Configuration options: [None] [360K, 5.25 in.] [1.2M, 5.25 in.] [720K, 3.5 in.] [1.44M, 3.5 in.] [2.88M, 3.5 in.]

### Floppy 3 Mode Support [Disabled]

This is required to support older Japanese floppy drives. Floppy 3 Mode support will allow reading and writing of 1.2MB (as opposed to 1.44MB) on a 3.5-inch diskette. Configuration options: [Disabled] [Drive A] [Drive B] [Both]

# 4. BIOS SETUP

## 4.3.1 Primary & Secondary Master/Slave

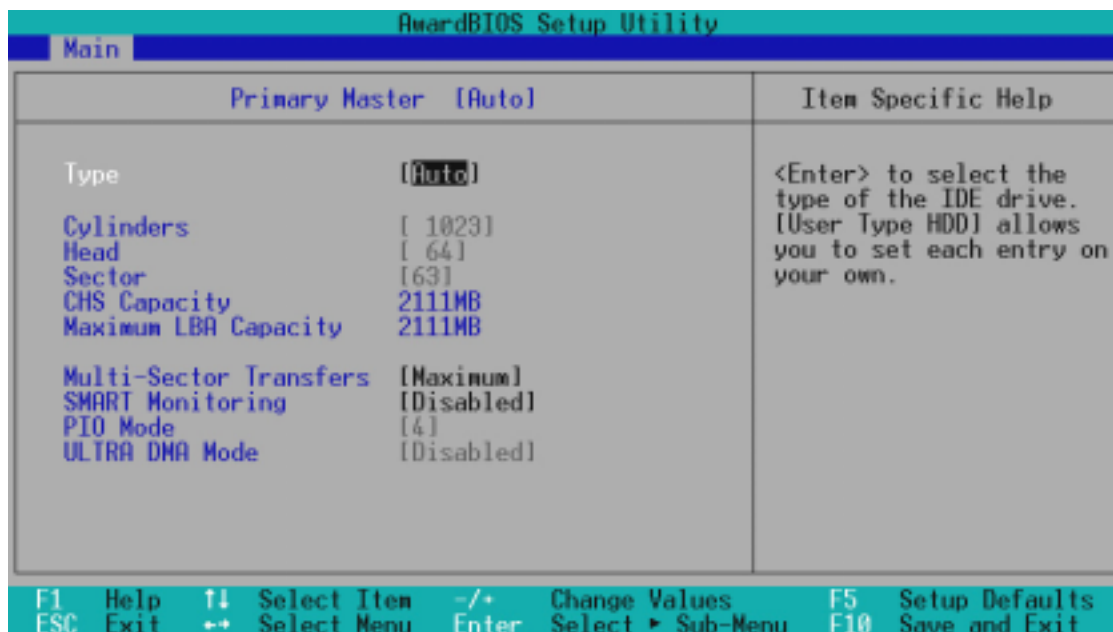

**NOTE:** Before attempting to configure a hard disk drive, make sure you have the configuration information supplied by the manufacturer of the drive. Incorrect settings may cause your system to not recognize the installed hard disk. To allow the BIOS to detect the drive type automatically, select [Auto].

### Type [Auto]

Select [Auto] to automatically detect an IDE hard disk drive. If automatic detection is successful, the correct values will be filled in for the remaining fields on this sub-menu. If automatic detection fails, your hard disk drive may be too old or too new. You can try updating your BIOS or enter the IDE hard disk drive parameters manually.

**NOTE:** After the IDE hard disk drive information has been entered into BIOS, new IDE hard disk drives must be partitioned (such as with FDISK) and then formatted before data can be read from and write on. Primary IDE hard disk drives must have its partition set to *active* (also possible with FDISK).

Other options for the **Type** field are:

-----  
**[None]** - to disable IDE devices

# 4. BIOS SETUP

**IMPORTANT:** If your hard disk was already formatted on an older previous system, incorrect parameters may be detected. You will need to enter the correct parameters manually or use low-level format if you do not need the data stored on the hard disk. If the parameters listed differ from the ones used when the disk was formatted, the disk will not be readable. If the auto-detected parameters do not match the ones that should be used for your disk, you should enter the correct ones manually by setting [User Type HDD].

## [User Type HDD]

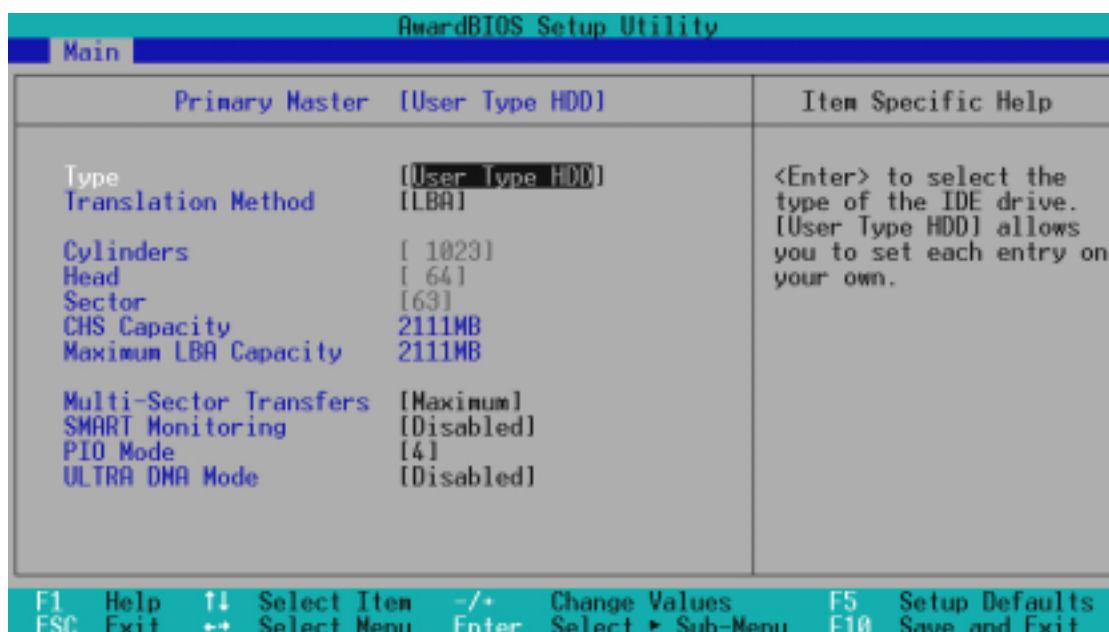

Manually enter the number of cylinders, heads and sectors per track for your drive. Refer to your drive documentation or look on the drive for this information. If no drive is installed or if you are removing a drive and not replacing it, select [None].

### Translation Method [LBA]

Select the hard disk drive type in this field. When Logical Block Addressing is enabled, 28-bit addressing of the hard drive is used without regard for cylinders, heads, or sectors. Note that LBA Mode is necessary for drives with greater than 504MB in storage capacity. Configuration options: [LBA] [LARGE] [Normal] [Match Partition Table] [Manual]

### Cylinders

This field configures the number of cylinders. Refer to your drive documentation to determine the correct value to enter into this field. **NOTE:** To make changes to this field, the **Type** field must be set to [User Type HDD] and the **Translation Method** field must be set to [Manual].

## 4. BIOS SETUP

---

### **Head**

This field configures the number of read/write heads. Refer to your drive documentation to determine the correct value to enter into this field. **NOTE:** To make changes to this field, the **Type** field must be set to [User Type HDD] and the **Translation Method** field must be set to [Manual].

### **Sector**

This field configures the number of sectors per track. Refer to your drive documentation to determine the correct value to enter into this field. **NOTE:** To make changes to this field, the **Type** field must be set to [User Type HDD] and the **Translation Method** field must be set to [Manual].

### **CHS Capacity**

This field shows the drive's maximum CHS capacity calculated automatically by the BIOS from the drive information you entered.

### **Maximum LBA Capacity**

This field shows the drive's maximum LBA capacity calculated automatically by the BIOS from the drive information you entered.

### **Multi-Sector Transfers [Maximum]**

This option automatically sets the number of sectors per block to the highest number supported by the drive. This field can also be configured manually. Note that when this field is automatically configured, the set value may not always be the fastest value for the drive. Refer to the documentation that came with your hard drive to determine the optimal value and set it manually. **NOTE:** To make changes to this field, the **Type** field must be set to [User Type HDD]. Configuration options: [Disabled] [2 Sectors] [4 Sectors] [8 Sectors] [16 Sectors] [32 Sectors] [Maximum]

### **SMART Monitoring [Disabled]**

This allows the enabling or disabling of the S.M.A.R.T. (Self-Monitoring, Analysis and Reporting Technology) system which utilizes internal hard disk drive monitoring technology. This feature is normally disabled because system resources used in this feature may decrease system performance. Configuration options: [Disabled] [Enabled]

### **PIO Mode [4]**

This option lets you set a PIO (Programmed Input/Output) mode for the IDE device. Modes 0 through 4 provide successively increased performance. Configuration options: [0] [1] [2] [3] [4]

### **Ultra DMA Mode [Disabled]**

Ultra DMA capability allows improved transfer speeds and data integrity for compatible IDE devices. Set to [Disabled] to suppress Ultra DMA capability. **NOTE:** To make changes to this field, the **Type** field must be set to [User Type HDD]. Configuration options: [0] [1] [2] [3] [4] [Disabled]

## 4. BIOS SETUP

---

**Other options for “Type:” are:**

**[CD-ROM]** - for IDE CD-ROM drives

**[LS-120]** - for LS-120 compatible floppy disk drives

**[ZIP-100]** - for ZIP-100 compatible disk drives

**[MO]** - for IDE magneto optical disk drives

**[Other ATAPI Device]** - for IDE devices not listed here

After using the legend keys to make your selections on this sub-menu, press the <Esc> key to exit back to the Main menu. When the Main menu appears, you will notice that the drive size appear in the field for the hard disk drive that you just configured.

-----

### **Language [English]**

This allows selection of the BIOS' displayed language. Currently only English is available.

### **Supervisor Password [Disabled], User Password [Disabled]**

These fields allow you to set the passwords. To set any of the passwords, highlight the appropriate field and press <Enter>.

Type in a password and press <Enter>. You can type up to eight alphanumeric characters. Symbols and other keys are ignored. To confirm the password, type the password again and press the <Enter>. The password is now set to [Enabled]. This password allows full access to the BIOS Setup menus.

To clear the password, highlight this field and press <Enter>. The same dialog box as above will appear. Press <Enter> and the password will be set to [Disabled].

### **A Note about Passwords**

The BIOS Setup program allows you to specify passwords in the Main menu. The passwords control access to the BIOS during system startup. The passwords are not case sensitive. In other words, it makes no difference whether you enter a password using upper or lowercase letters.

The BIOS Setup program allows you to specify two separate passwords: a Supervisor password and a User password. When disabled, anyone may access all BIOS Setup program functions. When enabled, the Supervisor password is required for entering the BIOS Setup program and having full access to all Security menu options.



# 4. BIOS SETUP

## Forgot the password?

If you forgot the password, you can clear the password by erasing the CMOS Real Time Clock (RTC) RAM. The RAM data containing the password information is powered by the onboard button cell battery. To erase the RTC RAM: (1) Unplug your computer, (2) Short the solder points, (3) Turn ON your computer, (4) Hold down <Delete> during bootup and enter BIOS setup to re-enter user preferences.

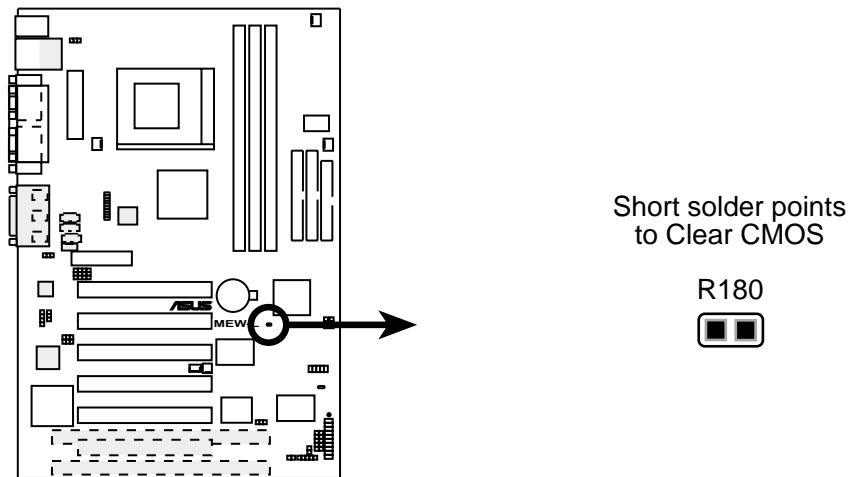

**MEW-L Clear RTC RAM**

## Halt On [All Errors]

This field determines which types of errors will cause the system to halt. Configuration options: [All Errors] [No Error] [All but Keyboard] [All but Disk] [All but Disk/Keyboard]

## Installed Memory [XXX MB]

This field displays the amount of conventional memory detected by the system during bootup. You do not need to make changes to this field. This is a display only field.

# 4. BIOS SETUP

## 4.4 Advanced Menu

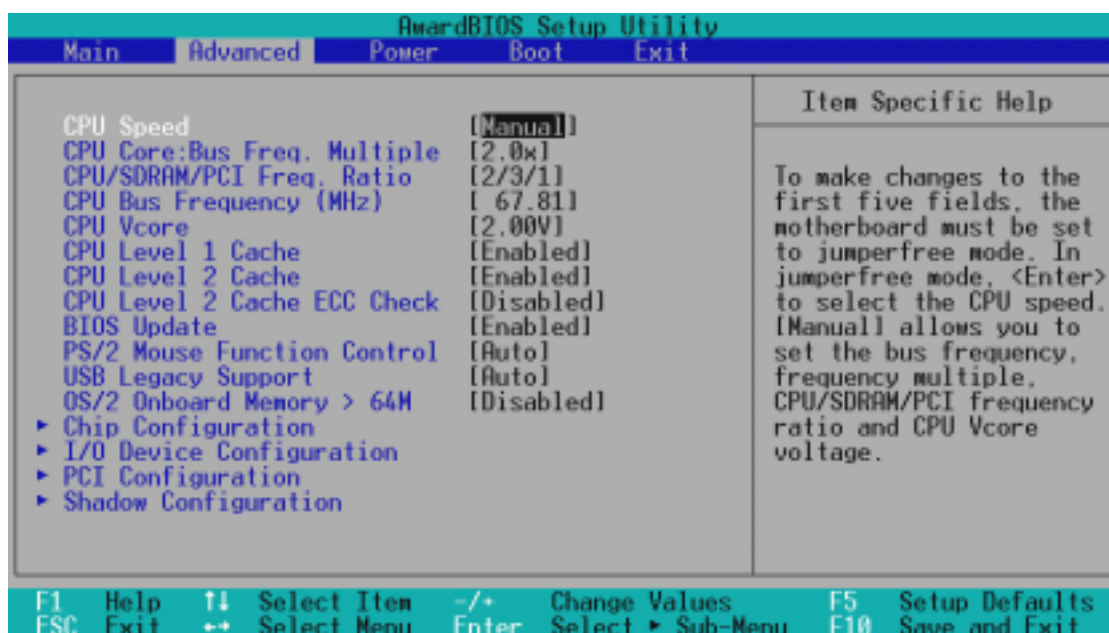

### CPU Speed [Manual]

When the motherboard is set to JumperFree™ mode, this field allows you to select the internal speed of your CPU. Select [Manual] if you want to make changes to the subsequent four fields. Configuration options: [Manual] [266MHz] [300MHz] [333MHz] [366MHz] [400MHz] [433MHz] [466MHz]

### CPU Core:Bus Freq. Multiple (when CPU Speed is set to [Manual])

This field is for unlocked processors only. If your socket 370 processor's Frequency Multiple is locked, setting the Frequency Multiple here will have no effect. This field sets the frequency multiple between the CPU's *internal* frequency and *external* frequency. This must be set in conjunction with **CPU Bus Frequency** to match the speed of your CPU. Configuration options: [2.0x] [2.5x] [3.0x]...[7.0x] [7.5x] [8.0x]

### CPU/SDRAM/PCI Freq. Ratio (when CPU Speed is set to [Manual])

This field determines whether the memory clock frequency is set to be in synchronous or asynchronous mode with respect to the **CPU Bus Frequency**. Each of the two memory data transfer methods leads to a set of 16 CPU Bus Frequency selections. Configuration options: [2/3/1] [3/3/1]

### CPU Bus Frequency (MHz) (when CPU Speed is set to [Manual])

This feature tells the clock generator what frequency to send to the CPU, DRAM, and chipset. The bus frequency (external frequency) multiplied by the bus multiple equals the CPU's internal frequency (the **CPU speed**). The configuration options vary depending on the **CPU/SDRAM/PCI Frequency Ratio**.

## 4. BIOS SETUP

---

### **CPU Vcore (when CPU Speed is set to [Manual])**

This field displays the core voltage supplied to the CPU. If you want to set it manually, always refer to the CPU documentation for the reasonable voltage range. Configuration options: [2.40V] [2.30V] [2.20V] [2.10V] [2.05V] [2.00V]

### **CPU Level 1 Cache, CPU Level 2 Cache [Enabled]**

These fields allow you to choose from the default of [Enabled] or choose [Disabled] to turn ON or OFF the CPU's Level 1 and Level 2 built-in cache. Configuration options: [Disabled] [Enabled]

### **CPU Level 2 Cache ECC Check [Disabled]**

This function controls the ECC capability in the CPU level 2 cache. Configuration options: [Disabled] [Enabled]

### **BIOS Update [Enabled]**

This functions as an update loader integrated into the BIOS to supply the processor with the required data. In the default position of [Enabled], the BIOS will load the update on all processors during system bootup. Configuration options: [Disabled] [Enabled]

### **PS/2 Mouse Function Control [Auto]**

The default of [Auto] allows the system to detect a PS/2 mouse on startup. If detected, IRQ12 will be used for the PS/2 mouse. IRQ12 will be reserved for expansion cards only if a PS/2 mouse is not detected. [Enabled] will always reserve IRQ12, whether on startup a PS/2 mouse is detected or not. Configuration options: [Enabled] [Auto]

### **USB Legacy Support [Auto]**

This motherboard supports Universal Serial Bus (USB) devices. The default of [Auto] allows the system to detect a USB device on startup. If detected, the USB controller will be enabled. If not detected, the USB controller will be disabled. When this field is set to [Disabled], the USB controller is disabled no matter whether you are using a USB device or not. Configuration options: [Disabled] [Enabled] [Auto]

### **OS/2 Onboard Memory > 64M [Disabled]**

When using OS/2 operating systems with installed DRAM of greater than 64MB, you need to set this option to [Enabled]; otherwise, leave this on [Disabled]. Configuration options: [Disabled] [Enabled]

# 4. BIOS SETUP

## 4.4.1 Chip Configuration



(scroll down to see more items, as shown here)

### SDRAM Configuration [By SPD]

This sets the optimal timings for items 2–4, depending on the memory modules that you are using. Default setting is [By SPD], which configures items 2–4 by reading the contents in the SPD (Serial Presence Detect) device. The EEPROM on the memory module stores critical parameter information about the module, such as memory type, size, speed, voltage interface, and module banks. Configuration options: [User Define] [7ns (143MHz)] [8ns (125MHz)] [By SPD]

### SDRAM CAS Latency

This controls the latency between the SDRAM read command and the time that the data actually becomes available. **NOTE:** To make changes to this field, the **SDRAM Configuration** field must be set to [User Define].

### SDRAM RAS to CAS Delay

This controls the latency between the SDRAM active command and the read/write command. **NOTE:** To make changes to this field, the **SDRAM Configuration** field must be set to [User Define].

### SDRAM RAS Precharge Time

This controls the idle clocks after issuing a precharge command to the SDRAM. **NOTE:** To make changes to this field, the **SDRAM Configuration** field must be set to [User Define].

## 4. BIOS SETUP

---

### **SDRAM Cycle Time (Tras, Trc) [5T, 7T]**

This feature controls the number of SDRAM clocks used per access cycle. Configuration options: [5T, 7T] [6T, 8T]

### **SDRAM Address Setup Time [1T Delay]**

Configuration options: [No Delay] [1T Delay]

### **SDRAM Page Closing Policy [All Banks]**

This feature controls whether the graphic and memory controller hub will precharge one or all banks after a page miss. Configuration options: [One Bank] [All Banks]

### **CPU Latency Timer [Enabled]**

Configuration options: [Disabled] [Enabled]

### **Onboard VGA [Enabled]**

Leave on default setting if you want to use the onboard VGA. If this field is disabled, all **Display Cache** configurations will not be available. Configuration options: [Disabled] [Enabled]

### **Graphics Window Size [64MB]**

This feature allows you to select the size of mapped memory for AGP graphic data. Configuration options: [64MB] [32MB]

### **Memory Hole At 15M-16M [Disabled]**

This field allows you to reserve an address space for ISA expansion cards that require it. Configuration options: [Disabled] [Enabled]

### **PCI 2.1 Support [Enabled]**

This function allows you to enable or disable PCI 2.1 features including passive release and delayed transaction. Configuration options: [Disabled] [Enabled]

### **High Priority PCI Mode [Enabled]**

This field allows you to give PCI slot 1 a higher priority. You may want to leave on the default setting if you are using an IEEE-1394 PCI card. Configuration options: [Disabled] [Enabled]

### **Onboard PCI IDE Enable [Both]**

You can select to enable the primary IDE channel, secondary IDE channel, both, or disable both channels. Configuration options: [Both] [Primary] [Secondary] [Disabled]

### **Onboard ISA Bridge [Enabled]**

If you are not using any ISA cards, you may disable this field. When this field is disabled, the **8-bit** and **16-bit I/O Recovery Time** configurations will not be available. Configuration options: [Disabled] [Enabled]

### **8-bit, 16-bit I/O Recovery Time [3.5 BUSCLK]**

Leave on default setting.

# 4. BIOS SETUP

## 4.4.2 I/O Device Configuration

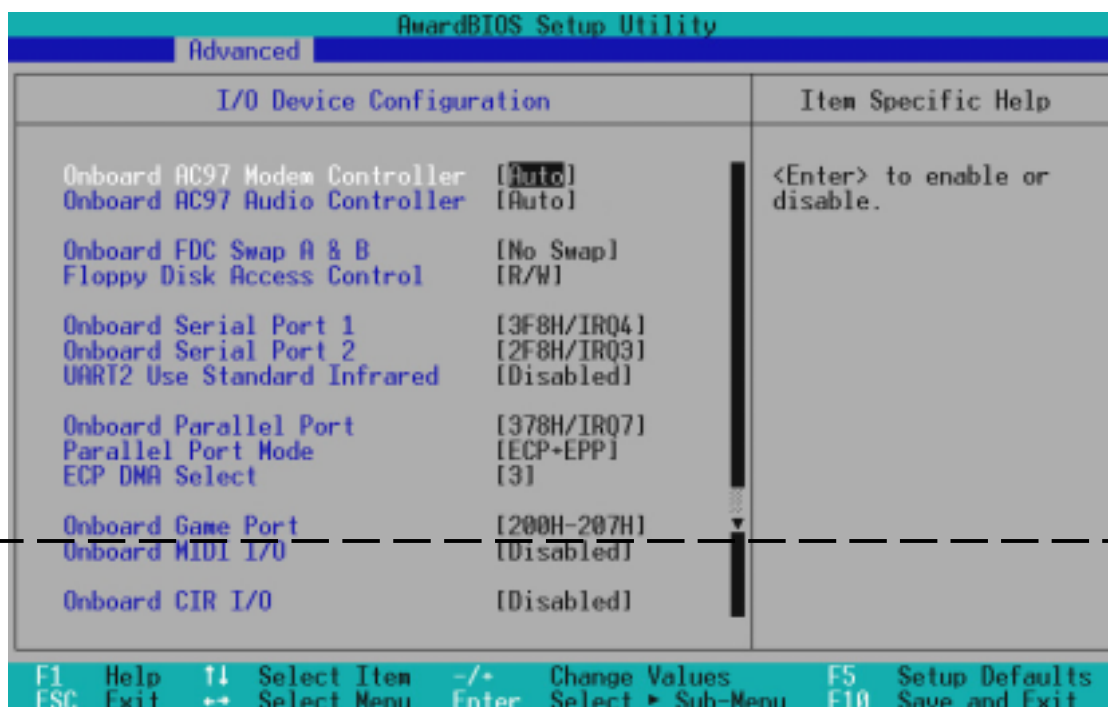

(scroll down to see more items, as shown here)

### Onboard AC97 Modem Controller, Audio Controller [Auto]

[Auto] allows the motherboard's BIOS to detect whether you are using any modem/audio device. If a modem/audio device is detected, the onboard modem/audio controller will be enabled; if no modem/audio device is detected, the onboard modem/audio controller will be disabled. If you have conflicts with the onboard modem/audio controller, you may set the appropriate field to [Disabled]. Configuration options: [Auto] [Disabled]

### Onboard FDC Swap A & B [No Swap]

This field allows you to reverse the hardware drive letter assignments of your floppy disk drives. Configuration options: [No Swap] [Swap AB]

### Floppy Disk Access Control [R/W]

When set to [Read Only], this field protects files from being copied to floppy disks by allowing reads from the floppy disk drive but not writes. The setup default [R/W] allows both reads and writes. Configuration options: [R/W] [Read Only]

### Onboard Serial Port 1 [3F8H/IRQ4], Onboard Serial Port 2 [2F8H/IRQ3]

These fields allow you to set the addresses for the onboard serial connectors. Serial Port 1 and Serial Port 2 must have different addresses. Configuration options: [3F8H/IRQ4] [2F8H/IRQ3] [3E8H/IRQ4] [2E8H/IRQ10] [Disabled]

## 4. BIOS SETUP

---

### **UART2 Use Standard Infrared [Disabled]**

When enabled, this field activates the onboard standard infrared feature and sets the second serial UART to support the infrared module connector on the motherboard. If your system already has a second serial port connected to the onboard COM2 connector, it will no longer work if you enable the infrared feature. See **IrDA-Compliant Infrared Module Connector** in **3.8 External Connectors**. Configuration options: [Disabled] [Enabled]

### **Onboard Parallel Port [378H/IRQ7]**

This field sets the address of the onboard parallel port connector. If you disable this feature, **Parallel Port Mode** and **ECP DMA Select** configurations will not be available. Configuration options: [Disabled] [378H/IRQ7] [278H/IRQ5]

### **Parallel Port Mode [ECP+EPP]**

This field allows you to set the operation mode of the parallel port. [Normal] allows normal-speed operation but in one direction only; [EPP] allows bidirectional parallel port operation; [ECP] allows the parallel port to operate in bidirectional DMA mode; [ECP+EPP] allows normal speed operation in a two-way mode. Configuration options: [Normal] [EPP] [ECP] [ECP+EPP]

### **ECP DMA Select [3]**

This field allows you to configure the parallel port DMA channel for the selected **ECP** mode. This selection is available only if you select [ECP] or [ECP+EPP] in **Parallel Port Mode** above. Configuration options: [1] [3] [Disabled]

### **Onboard Game Port [200H-207H]**

This field sets the address of the onboard game port connector. Configuration options: [Disabled] [200H-207H] [208H-20FH]

### **Onboard MIDI I/O [Disabled]**

This field sets the address of the onboard MIDI connector. Configuration options: [Disabled] [330H-331H] [300H-301H]

### **Onboard MIDI IRQ [xx]**

This field is not available if you select [Disabled] in **Onboard MIDI I/O**. Configuration options: [3] [4] [5] [7] [9] [10] [11] [12] [14] [15]

### **Onboard CIR I/O [Disabled]**

This field sets the address of the onboard Consumer IR connector. Configuration options: [Disabled] [2E0-2E8H] [3E0-3E8H]

### **Onboard CIR IRQ [xx]**

This field is not available if you select [Disabled] in **Onboard CIR I/O**. Configuration options: [3] [4] [5] [7] [9] [10] [11] [12] [14] [15]

# 4. BIOS SETUP

## 4.4.3 PCI Configuration

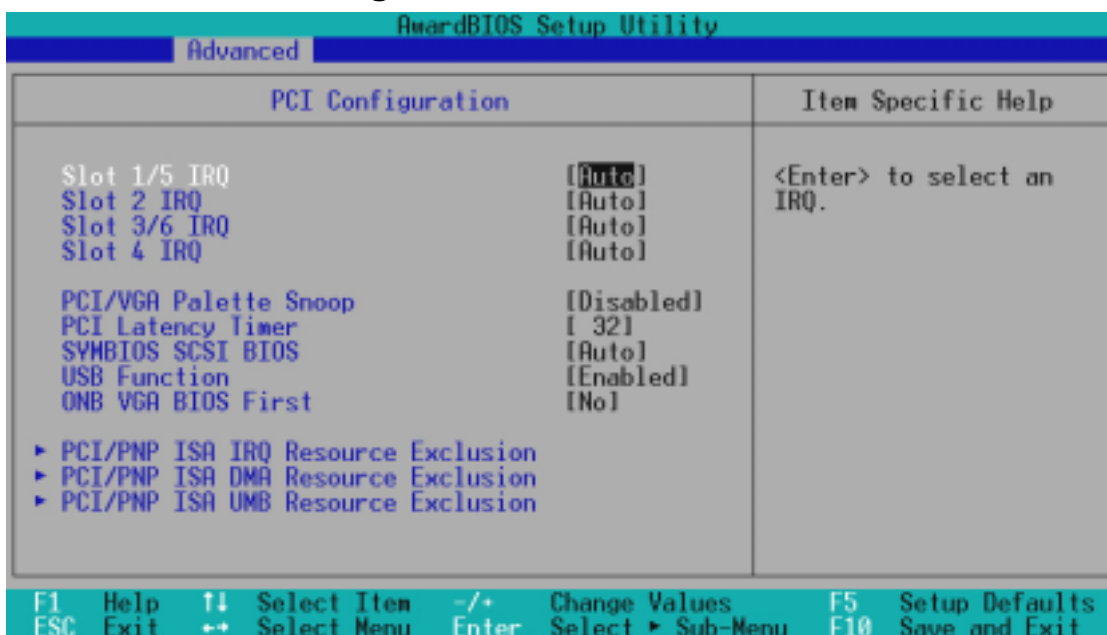

### Slot 1/5, Slot 2, Slot 3/6, Slot 4 IRQ [Auto]

These fields set how IRQ use is determined for each PCI slot. The default setting for each field is [Auto], which uses auto-routing to determine IRQ use. Configuration options: [Auto] [NA] [3] [4] [5] [7] [9] [10] [11] [12] [14] [15]

### PCI/VGA Palette Snoop [Disabled]

Some nonstandard VGA cards, such as graphics accelerators or MPEG Video Cards, may not show colors properly. The setting [Enabled] should correct this problem. Otherwise, leave this on the default setting of [Disabled]. Configuration options: [Disabled] [Enabled]

### PCI Latency Timer [32]

Leave on default setting for best performance vs. stability.

### SYMBIOS SCSI BIOS [Auto]

[Auto] allows the motherboard's BIOS to detect whether you have a Symbios SCSI card. If the Symbios SCSI card is detected, the motherboard's Symbios BIOS will be enabled; if no Symbios SCSI card is detected, the onboard Symbios SCSI BIOS will be disabled.

[Disabled] will disable the motherboard's Symbios SCSI BIOS so that the BIOS on an external Symbios SCSI card can be used. If your Symbios SCSI card does not have a BIOS, the Symbios SCSI card will not function. Configuration options: [Auto] [Disabled]



# 4. BIOS SETUP

## USB Function [Enabled]

This motherboard supports Universal Serial Bus (USB) devices. Set to [Enabled] if you want to use USB devices. Configuration options: [Disabled] [Enabled]

## ONB VGA BIOS First [No]

This field, when set to [Yes], gives priority to the onboard VGA BIOS over other VGA controllers. Configuration options: [No] [Yes]

## PCI/PNP ISA IRQ Resource Exclusion

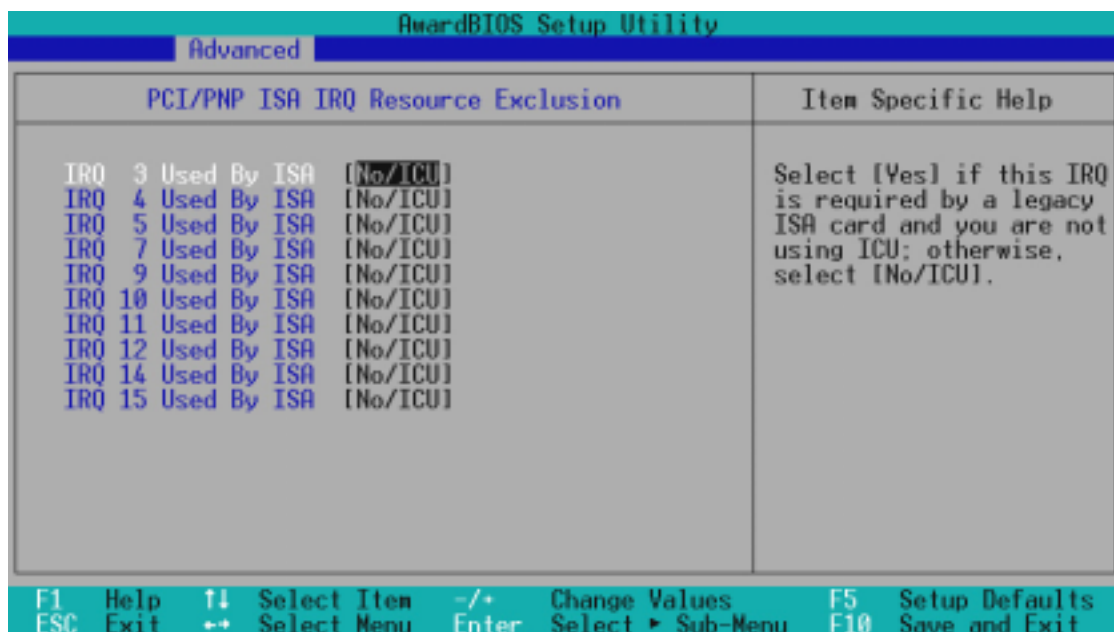

## IRQ XX Used By ISA [No/ICU]

These fields indicate whether or not the displayed IRQ for each field is being used by a legacy (non-PnP) ISA card. The default value indicates either that the displayed IRQ is not used or that ISA Configuration Utility (ICU) is being used to determine if an ISA card is using that IRQ. If you install a legacy ISA card that requires a unique IRQ and you are not using an ICU, you must set the field for that IRQ to [Yes]. For example: If you install a legacy ISA card that requires IRQ 10, then set **IRQ10 Used By ISA** to [Yes]. Configuration options: [No/ICU] [Yes]

# 4. BIOS SETUP

## PCI/PNP ISA DMA Resource Exclusion

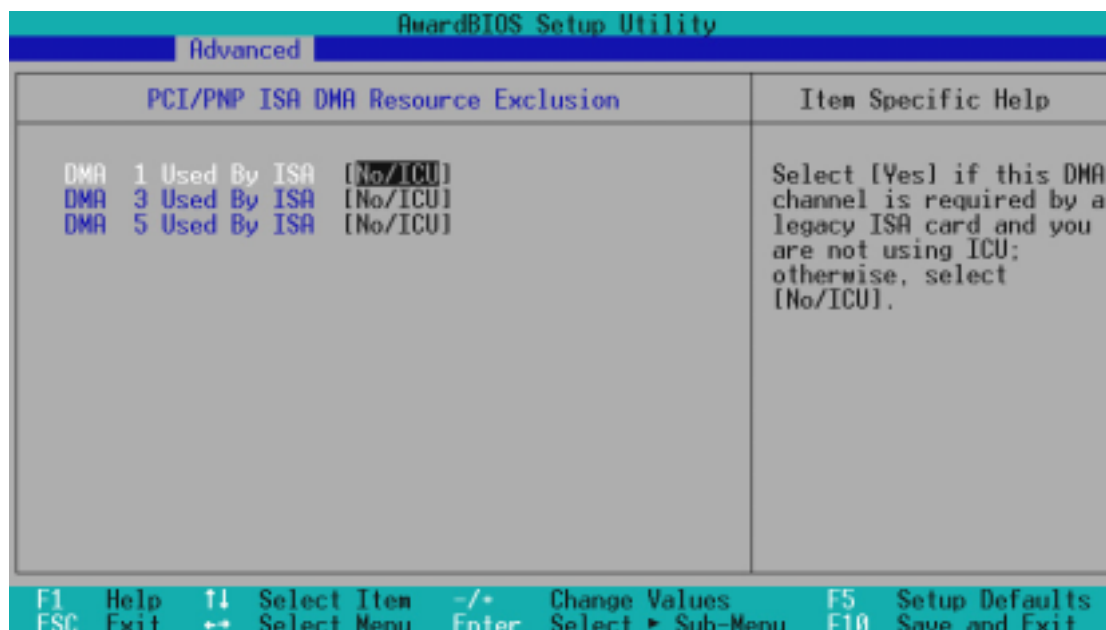

### DMA x Used By ISA [No/ICU]

These fields indicate whether or not the displayed DMA channel for each field is being used by a legacy (non-PnP) ISA card. The default setting indicates either that the displayed DMA channel is not used or an ICU is being used to determine if an ISA card is using that channel. If you install a legacy ISA card that requires a unique DMA channel, and you are not using an ICU, you must set the field for that channel to [Yes]. Configuration options: [No/ICU] [Yes]

## PCI/PNP ISA UMB Resource Exclusion

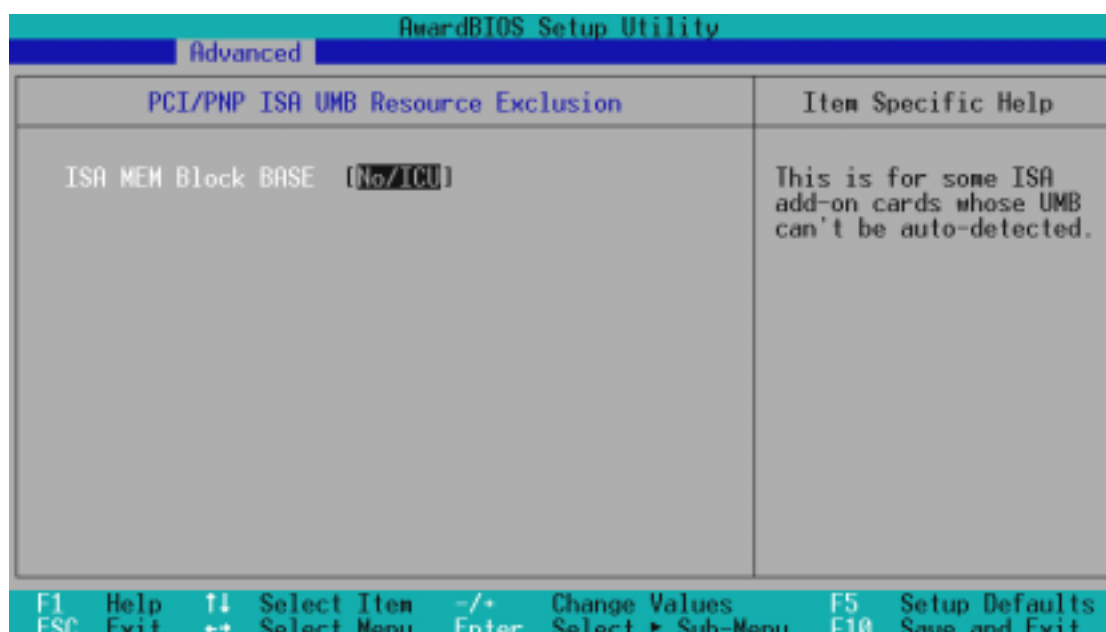

# 4. BIOS SETUP

## ISA MEM Block BASE [No/ICU]

This field allows you to set the base address and block size of a legacy ISA card that uses any memory segment within the C800 and DFFF address range. If you have such a card and you are not using an ICU to specify its address range, select a base address from the six available options; the **ISA MEM Block SIZE** field will then appear for selecting the block size. If you have more than one legacy ISA card in your system that requires the use of this address range, you can increase the block size to 8K, 16K, 32K, or 64K. If you are using an ICU to accomplish this task, leave **ISA MEM Block BASE** to its default setting of [No/ICU]. Configuration options: [No/ICU] [C800] [CC00] [D000] [D400] [D800] [DC00]

## 4.4.4 Shadow Configuration

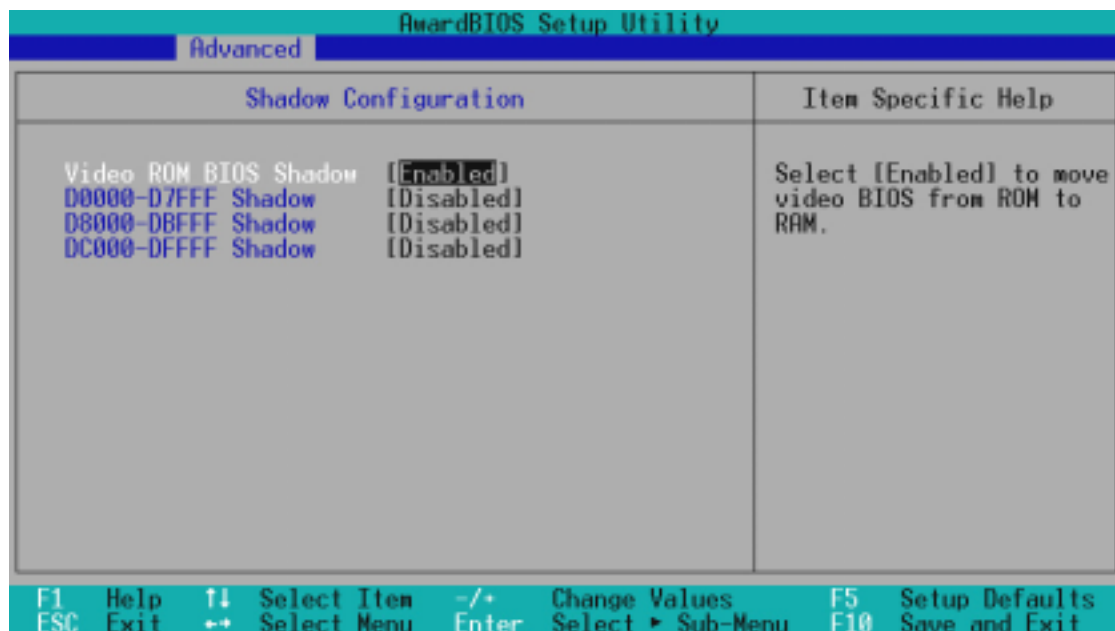

### Video ROM BIOS Shadow [Enabled]

This field allows you to change the video BIOS location from ROM to RAM. Relocating to RAM enhances system performance, as information access is faster than the ROM. Configuration options: [Disabled] [Enabled]

### D0000-DFFFF Shadow [Disabled]

These fields are used for shadowing other expansion card ROMs. If you install other expansion cards with ROMs on them, you will need to know which addresses the ROMs use to shadow them specifically. Shadowing a ROM reduces the memory available between 640K and 1024K by the amount used for this purpose. Configuration options: [Disabled] [Enabled]

# 4. BIOS SETUP

## 4.5 Power Menu

The Power menu allows you to reduce power consumption. This feature turns OFF the video display and shuts down the hard disk after a period of inactivity.

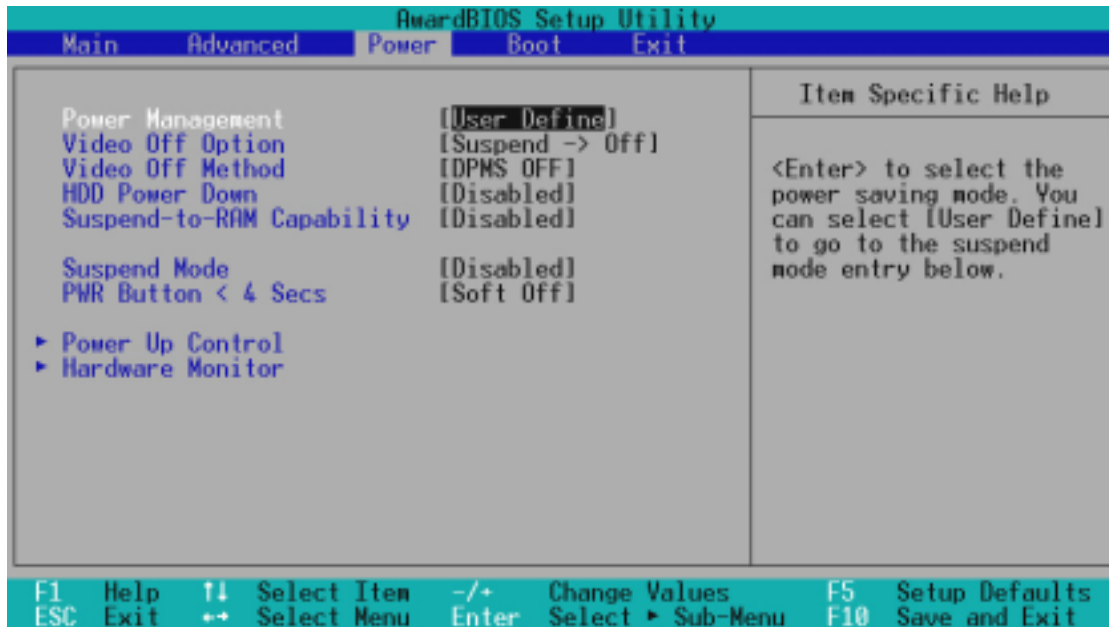

### Power Management [User Define]

This option must be enabled to use any of the automatic power saving features. If this menu item is set to [Disabled], power management features will not function regardless of other field settings on this menu. The [User Define] option allows you to make your own selections in the Power menu. When set to [Max Saving], system power will be conserved to its greatest amount. The **Suspend Mode** field will then be set to predefined value that ensures maximum power savings.

This field acts as the master control for the power management modes. [Max Saving] puts the system into power saving mode after a brief period of system inactivity; [Min Saving] is almost the same as [Max Saving] except that the system inactivity period is longer; [Disabled] disables the power saving features; [User Define] allows you to set power saving options according to your preference. Configuration options: [User Define] [Disabled] [Min Saving] [Max Saving]

**IMPORTANT:** Advanced Power Management (APM) should be installed to keep the system time updated when the computer enters suspend mode activated by the BIOS Power Management. For DOS environments, you need to add the statement, DEVICE=C:\DOS\POWER.EXE, to your CONFIG.SYS file. For Windows 3.x and Windows 95, you need to install Windows with the APM feature. For Windows 98 and later, APM is automatically installed. A battery and power cord icon labeled “Power Management” will appear in the “Control Panel.” Choose “Advanced” in the Power Management Properties dialog box.

## 4. BIOS SETUP

---

### **Video Off Option [Suspend -> Off ]**

This field determines when to activate the video OFF feature for monitor power management. Configuration options: [Always On] [Suspend -> Off]

### **Video Off Method [DPMS OFF]**

This field defines the video OFF features. The DPMS (Display Power Management System) feature allows the BIOS to control the video display card if it supports the DPMS feature. [Blank Screen] only blanks the screen (use this for monitors without power management or “green” features. If set up in your system, your screen saver will not display with [Blank Screen] selected). [V/H SYNC+Blank] blanks the screen and turns OFF vertical and horizontal scanning. Configuration options: [Blank Screen] [V/H SYNC+Blank] [DPMS Standby] [DPMS Suspend] [DPMS OFF] [DPMS Reduce ON]

### **HDD Power Down [Disabled]**

Shuts down any IDE hard disk drives in the system after a period of inactivity as set in this user-configurable field. This feature does not affect SCSI hard drives. Configuration options: [Disabled] [1 Min] [2 Min] [3 Min]...[15 Min]

### **Suspend-to-RAM Capability [Disabled]**

Suspend-to-RAM (STR) is an energy-saving feature. In Suspend-to-RAM state, all devices on the computer are turned OFF, except for the system RAM. Thus, the PC consumes less than 5 Watts of power. [Auto] allows the BIOS to detect if your power supply can supply at least 720mA on the +5VSB lead to support the STR function. If the power supply meets the requirement, the STR function will be enabled; if not, this function will be disabled. If the expansion cards you use on the motherboard do not support the STR function, you must leave this field on the default setting [Disabled]. Configuration options: [Auto] [Disabled]

### **Suspend Mode [Disabled]**

Sets the time period before the system goes into suspend mode. Configuration options: [Disabled] [1~2 Min] [2~3 Min] [4~5 Min] [8~9 Min] [20 Min]...[1 Hour]

### **PWR Button < 4 Secs [Soft off]**

When set to [Soft off], the ATX switch can be used as a normal system power-OFF button when pressed for less than 4 seconds. [Suspend] allows the button to have a dual function where pressing less than 4 seconds will place the system in sleep mode or wake up the system. Regardless of the setting, holding the ATX switch for more than 4 seconds will power OFF the system. Configuration options: [Soft off] [Suspend]

# 4. BIOS SETUP

## 4.5.1 Power Up Control

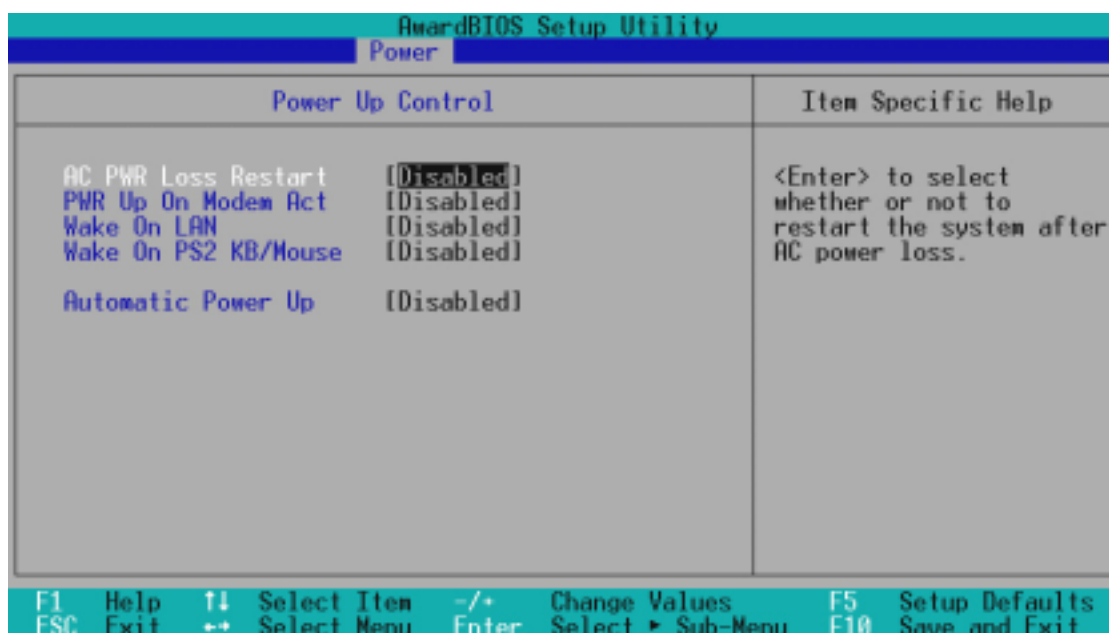

### AC PWR Loss Restart [Disabled]

This allows you to set whether you want your system to reboot after the power has been interrupted. [Disabled] leaves your system OFF and [Enabled] reboots your system. Configuration options: [Disabled] [Enabled]

### PWR Up On Modem Act [Disabled]

This allows either settings of [Enabled] or [Disabled] for powering up the computer when the modem receives a call while the computer is in Soft-off mode. **NOTE:** The computer cannot receive or transmit data until the computer and applications are fully running, thus connection cannot be made on the first try. Turning an external modem OFF and then back ON while the computer is OFF causes an initialization string that will also cause the system to power ON. Configuration options: [Disabled] [Enabled]

### Wake On LAN [Enabled]

Wake-On-LAN allows your computer to be booted from another computer via a network by sending a wake-up frame or signal. Configuration options: [Disabled] [Enabled]

**IMPORTANT:** This feature requires an optional network interface with Wake-On-LAN and an ATX power supply with at least 720mA +5V standby power.

## 4. BIOS SETUP

---

### **Wake On PS2 KB/Mouse [Disabled]**

Set this field to [Enabled] if you wish to use your PS2 keyboard (by pressing the spacebar) or PS2 mouse (by clicking on the left button) to power up your computer. This feature requires an ATX power supply that can supply at least 300mA on the +5VSB lead. The default is set to [Disabled] because not all computers have the appropriate ATX power supply. Your computer will not power ON if you set this to [Enabled] and do not have the appropriate ATX power supply. Configuration options: [Disabled] [Enabled]

### **Automatic Power Up [Disabled]**

This allows an unattended or automatic system power up. You may configure your system to power up at a certain time of the day by selecting [Everyday] or at a certain time and day by selecting [By Date]. Configuration options: [Disabled] [Everyday] [By Date]

# 4. BIOS SETUP

## 4.5.2 Hardware Monitor

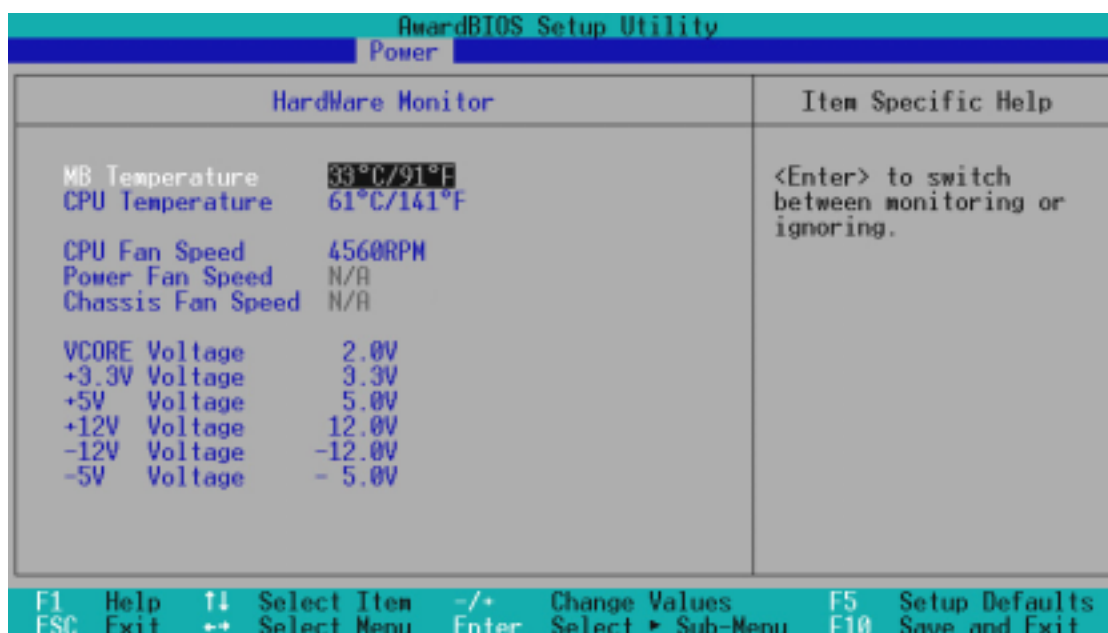

### MB Temperature, CPU Temperature [xxx°C/xxx°F]

The onboard hardware monitor is able to detect the MB (motherboard) and CPU temperatures. Set to [Ignore] only if necessary.

### CPU Fan, Power Fan, Chassis Fan Speed [xxxxRPM]

The onboard hardware monitor is able to detect the CPU fan speed, power supply fan speed, and the chassis fan speed in rotations per minute (RPM). The presence of the fans is automatically detected. Set to [Ignore] only if necessary.

### V CORE Voltage, +3.3V Voltage, +5V Voltage, +12V Voltage, -12V Voltage, -5V Voltage [xx.xV]

The onboard hardware monitor is able to detect the voltage output by the onboard voltage regulators. Set to [Ignore] only if necessary.

**NOTE:** If any of the monitored items is out of range, an error message will appear: “Hardware Monitor found an error. Enter Power setup menu for details”. You will then be prompted to “Press **F1** to continue, **DEL** to enter SETUP”.



# 4. BIOS SETUP

## 4.6 Boot Menu

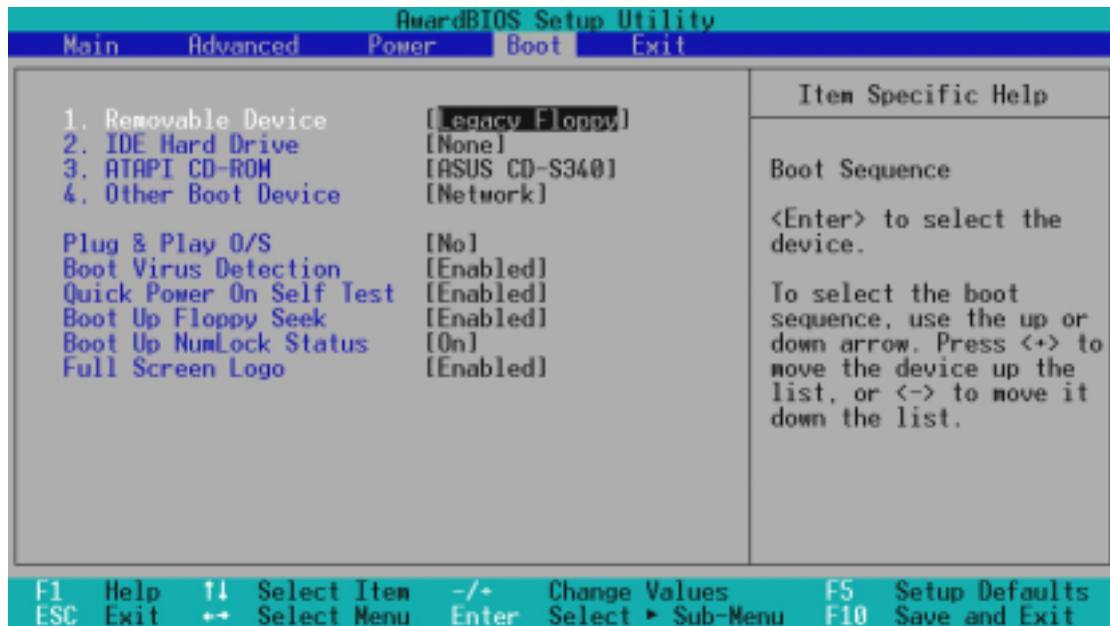

### Boot Sequence

The Boot menu allows you to select among the four possible types of boot devices listed using the up and down arrow keys. By using the <+> or <Space> key, you can promote devices and by using the <-> key, you can demote devices. Promotion or demotion of devices alters the priority which the system uses to search for a boot device on system power up. Configuration options: [Removable Devices] [IDE Hard Drive] [ATAPI CD-ROM] [Other Boot Device]

### Removable Device [Legacy Floppy]

Configuration options: [Disabled] [Legacy Floppy] [LS120] [ZIP-100] [ATAPI MO]

### IDE Hard Drive

This field allows you to select which IDE hard disk drive to use in the boot sequence. Pressing [Enter] will show the product IDs of all connected IDE hard disk drives or allow you to disable this field.

### ATAPI CD-ROM

This field allows you to select which ATAPI CD-ROM drive to use in the boot sequence. Pressing [Enter] will show the product IDs of all your connected ATAPI CD-ROM drives or allow you to disable this field.

### Other Boot Device Select [Network]

Configuration options: [Disabled] [Network] [SCSI Boot Device]

## 4. BIOS SETUP

---

### **Plug & Play O/S [No]**

This field allows you to use a Plug-and-Play (PnP) operating system to configure the PCI bus slots instead of using the BIOS. When [Yes] is selected, interrupts may be reassigned by the OS. When a non-PnP OS is installed or you want to prevent reassigning of interrupt settings, select the default setting of [No]. Configuration options: [No] [Yes]

### **Boot Virus Detection [Enabled]**

Configuration options: [Disabled] [Enabled]

### **Quick Power On Self Test [Enabled]**

Configuration options: [Disabled] [Enabled]

### **Boot Up Floppy Seek [Enabled]**

Configuration options: [Disabled] [Enabled]

### **Boot Up NumLock Status [On]**

Configuration options: [Off] [On]

### **Full Screen Logo [Enabled]**

Configuration options: [Disabled] [Enabled]

# 4. BIOS SETUP

## 4.7 Exit Menu

Once you have made all of your selections from the various menus in the Setup program, you should save your changes and exit Setup. Select **Exit** from the menu bar to display the following menu:

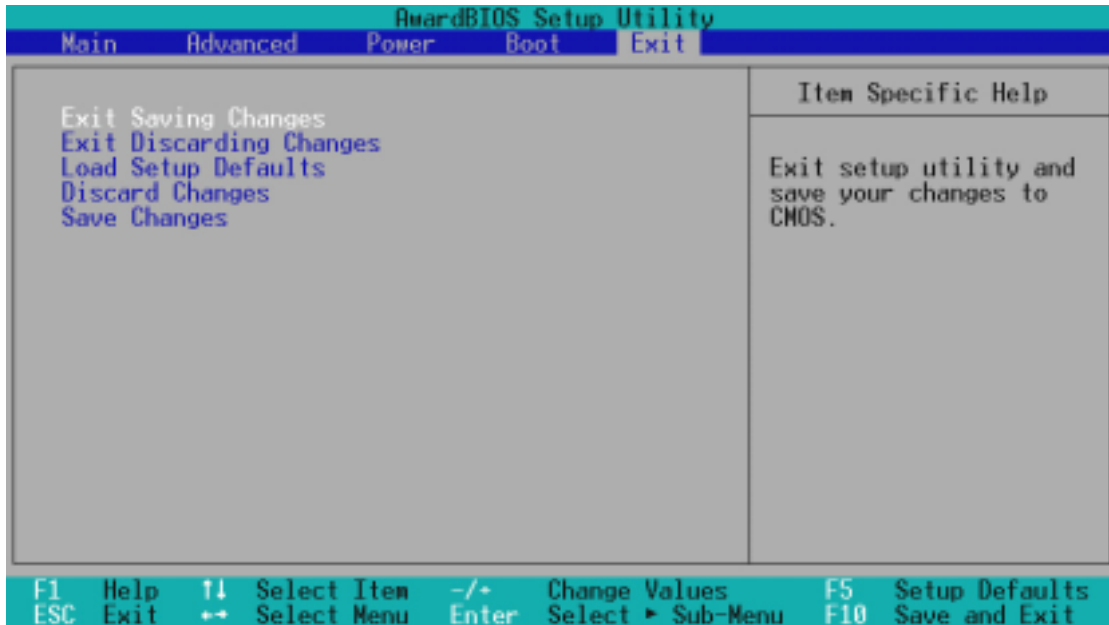

**NOTE:** Pressing <Esc> does not exit this menu. You must select one of the options from this menu or <F10> from the legend bar to exit this menu.

### Exit Saving Changes

Once you are finished making your selections, choose this option from the Exit menu to ensure the values you selected are saved to the CMOS RAM. The CMOS RAM is sustained by an onboard backup battery and stays ON even when the PC is turned OFF. Once this option is selected, a confirmation is asked. Select [Yes] to save changes and exit.

**NOTE:** If you attempt to exit the Setup program without saving your changes, the program will prompt you with a message asking if you want to save your changes before exiting. Pressing <Enter> will then save changes while exiting.

### Exit Discarding Changes

This option should only be used if you do not want to save the changes you have made to the Setup program. If you have made changes to fields other than system date, system time, and password, the system will ask for confirmation before exiting.

# 4. BIOS SETUP

---

## Load Setup Defaults

This option allows you to load the default values for each of the parameters on the Setup menus. When this option is selected or if <F5> is pressed, a confirmation is requested. Select [Yes] to load default values. You can now select **Exit Saving Changes** or make other changes before saving the values to the non-volatile RAM.

## Discard Changes

This option allows you to discard the selections you made and restore the values you previously saved. After selecting this option, a confirmation is requested. Select [Yes] to discard any changes and load the previously saved values.

## Save Changes

This option saves your selections without exiting the Setup program. You can then return to other menus and make changes. After selecting this option, all selections are saved and a confirmation is requested. Select [Yes] to save any changes to the non-volatile RAM.

# 5. SOFTWARE SETUP

## 5.1 ASUS Smart Motherboard Support CD

**NOTE:** The support CD contents are subject to change at any time without notice.

To begin using your support CD disc, just insert it into your CD-ROM drive and the support CD installation menu should appear. If the menu does not appear, double click or run **E:\ASSETUP.EXE** (assuming that your CD-ROM drive is drive **E:**).

### 5.1.1 Support CD Main Menu

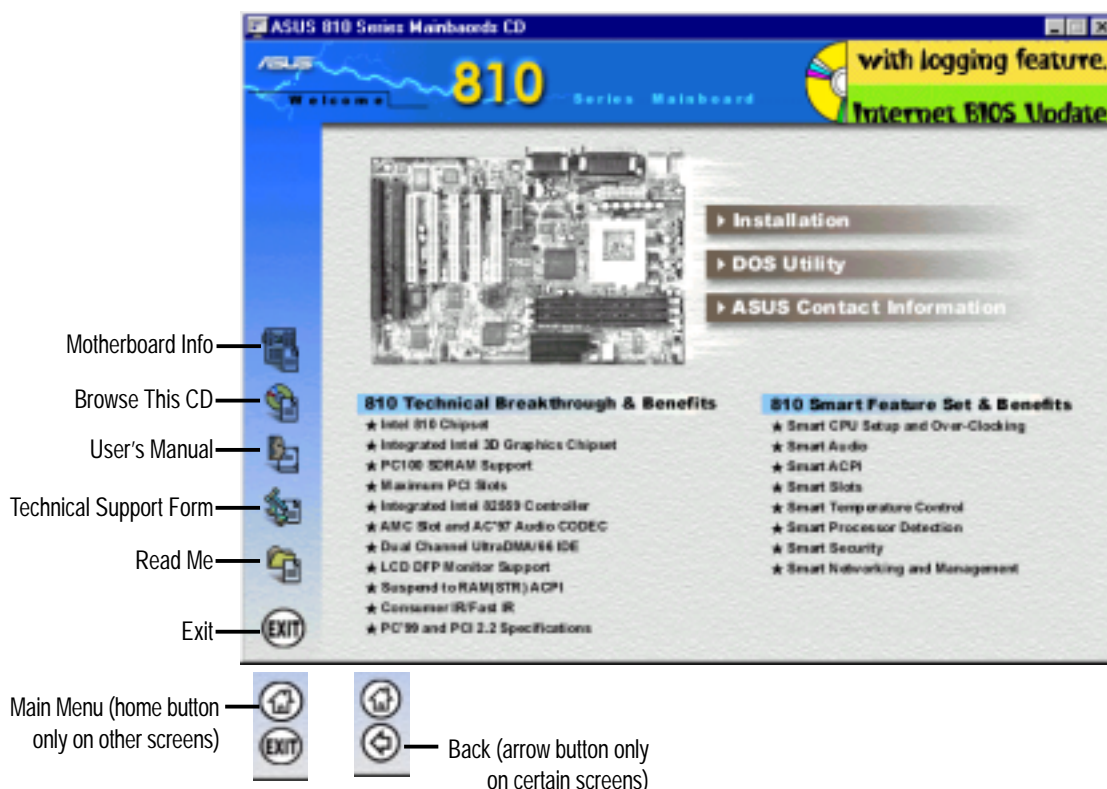

#### Navigation Button Descriptions

**Motherboard Info** displays information on your motherboard, BIOS, and CPU.

**Browse This CD** allows you to see the contents of the ASUS Support CD.

**User's Manual** displays the motherboard user's manual in pdf format.

**Technical Support Form** opens up a blank Technical Support Request Form for you to fill and print out when you run into technical difficulties and need technical assistance.

**Read Me** opens up a file containing additional notes.

**Home** returns you to the main menu of the support CD. (only on other screens)

**Exit** allows you to close the support CD.

**Back** returns you one screen back on the support CD.

# 5. SOFTWARE SETUP

## 5.1.2 Support CD Submenus

**NOTE:** The support CD contents are subject to change at any time without notice.

### Installation Submenu

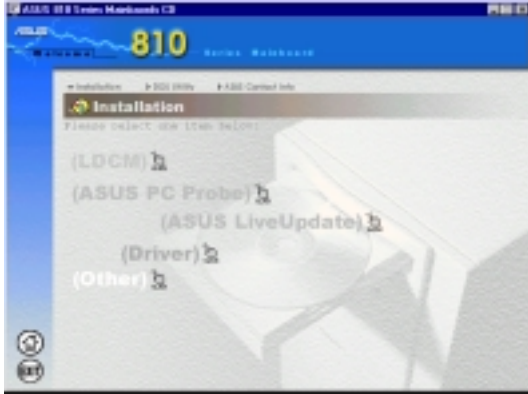

**LDCM:** Installs software to monitor PC system(s).

**ASUS Probe:** Installs a simple utility to monitor your computer's fan, temperature, and voltages.

**ASUS LiveUpdate:** Installs a program to help you update your BIOS or download a BIOS image file.

**Driver:** Installs the necessary drivers for your on-board components to work properly.

**Other:** Allows you to install additional software and utilities to help you make better use of your new motherboard.

### Driver

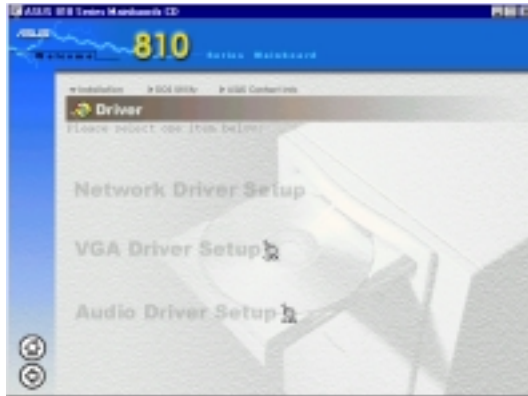

**Network Driver Setup:** Installs Intel's 8255x-based PCI ethernet adapter (10/100).

**VGA Driver Setup:** Intel's 810 System and Graphics Controller Driver.

**Audio Driver Setup:** Installs Intel's 82801AA/AB AC'97 Audio Controller: SigmaTel Codec.

### Other



**INF Update Utility for 810 Chipset:** This utility installs INF files in Windows for the following items: System and Graphics, LPC Interface, SM Bus, PCI Bridge, Bus Master IDE, USB Host, Controllers

**Intel Security Driver:** Installs a security controller for your Windows 95/98. Read the Release Notes during installation and the Readme file at the end of the installation for more information.

**YAMAHA S-YXG50:** Installs Yamaha's software synthesizer for playing MIDI files on a personal computer through software alone without using a hardware sound source such as a sound card. (YAMAHA, Soft Synthesizer, S-YXG50, Midplug, and XG studio are all trademarks of Yamaha Corp. Copyright 1996-1999 Yamaha Corporation, All Rights Reserved)

**YAMAHA XGStudio:** Installs Yamaha's XGStudio Mixer.

**Microsoft DirectX 6.0 Driver:** Installs Microsoft's DirectX 6.0 driver for Windows 95/98. Microsoft's DirectX is necessary for most multimedia applications to run.



# 5. SOFTWARE SETUP

**PC-cillin 98:** Installs Trend’s PC-cillin virus protection software. View the online help for more information.

**Adobe Acrobat Reader:** Installs the Adobe Acrobat Reader software necessary to view user’s manuals saved in PDF format. Updated or other language versions of this motherboard’s manual is available in PDF format at any of our web sites.

**Exit:** Returns to the Installation menu.

## DOS Utility Submenu

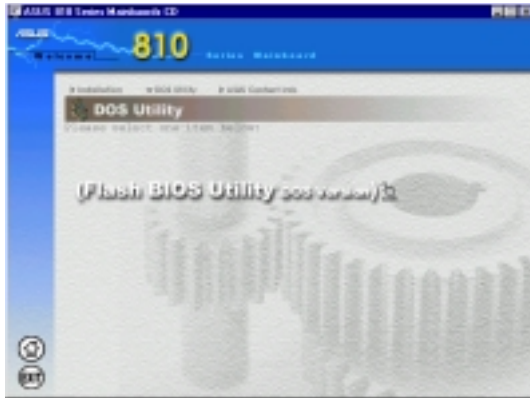

**Flash BIOS Utility (DOS Version):** Provides information on the Flash BIOS utility (AFLASH.EXE). Choose “Restart in MS-DOS mode” then type “aflash” from the AFLASH folder on the support CD.

## ASUS Contact Information Submenu



This page gives Marketing and Technical Support contact information, which is similar to the one in the beginning of this User’s Manual.

# 5. SOFTWARE SETUP

---

## 5.2 Operating Systems

Although ASUS motherboards passed testing on several operating systems, the operating system shown in these sections will be that of Microsoft's Windows 98. You should always use the latest operating system and updates when using new hardware to ensure full compliancy. For Windows 95, you must use OSR 2.0 or later. For Windows NT 4.0, you must use Service Pack 3.0 or later.

## 5.3 Starting Windows For the First Time

When you start Windows 98 for the first time after installing your motherboard, Windows will detect all plug-and-play devices. You can either follow the Add New Hardware Wizard to install the device drivers or click **Cancel**. When prompted to restart, select **No** and then follow the normal setup procedures later in this section.

**IMPORTANT:** Selecting **No** for the initial restart prompt is a necessary step because Windows may load an older display driver that is incompatible with the onboard VGA chip. Always use the driver available on the ASUS Support CD or an applicable driver update from your ASUS vendor or from the ASUS web site.

**NOTE:** Because there are various motherboard settings, options, and expansion cards, the following can only be used as a general reference and not an exact reflection of your system.



# 5. SOFTWARE SETUP

## 5.3.1 PCI Ethernet Controller Found

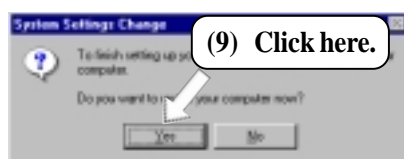
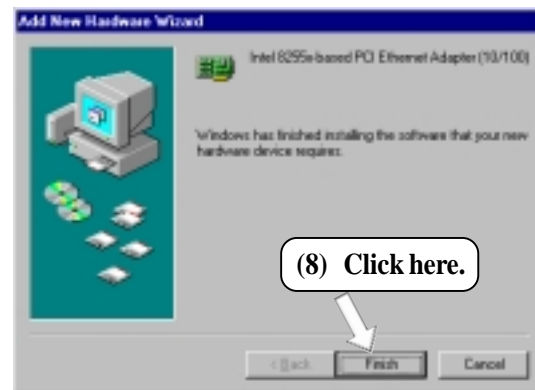
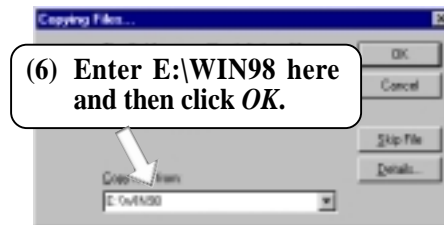

5. SAW SETUP  
Windows 98

# 5. SOFTWARE SETUP

## 5.4 LDCM Local Setup

### System Requirements

- Intel® Pentium® microprocessor or higher.
- Operating system: Microsoft Windows 95 (can be OEM Service Release 2), or Windows 98, or Windows NT 4.0 (Service Pack 4 or later).
- Microsoft Internet Explorer 4.01 or higher.
- Memory: 16 MB of RAM for Windows 95/98; 24 MB of RAM for Windows NT (32 MB recommended).
- Disk storage space: 100 MB of available hard disk space to install; 40-100 MB of available hard disk space to run (depending on cluster size).
- Hardware system: DM or SM BIOS is required for full LDCM functionality.
- Protocols: IP (Winsock-enabled) communication protocol loaded on the client. An IP stack is required on the client, regardless of whether the client accesses the network.
- Monitor resolution of 600x800, 256 colors or greater.

Insert the Support CD that came with your motherboard into your CD-ROM drive or double-click the CD drive icon in **My Computer** to bring up the setup screen.

**NOTE:** LDCM will not run if another hardware monitoring utility, such as ASUS PC Probe, is installed. To uninstall any program, see **5.10 Uninstalling Programs**.

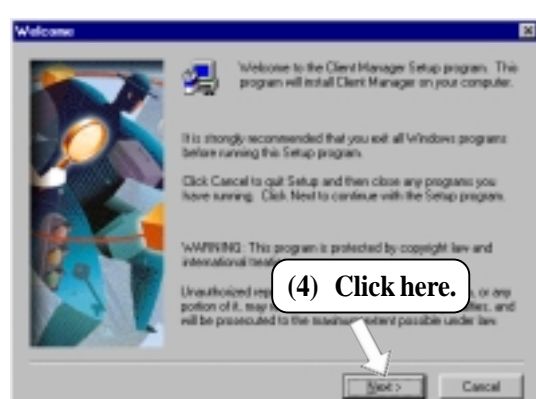
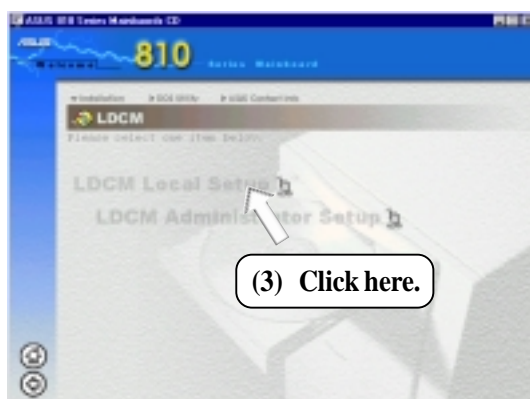
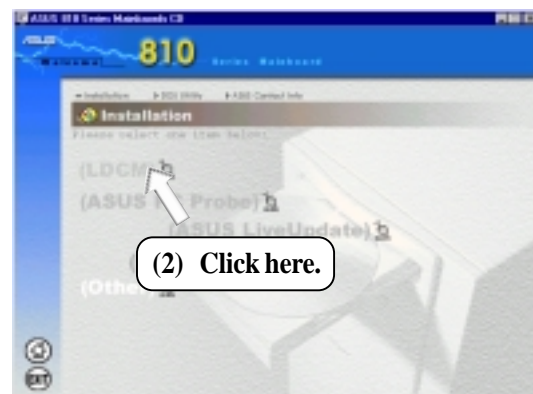

# 5. SOFTWARE SETUP

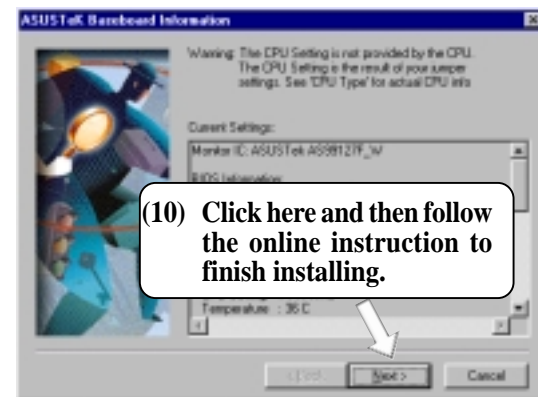
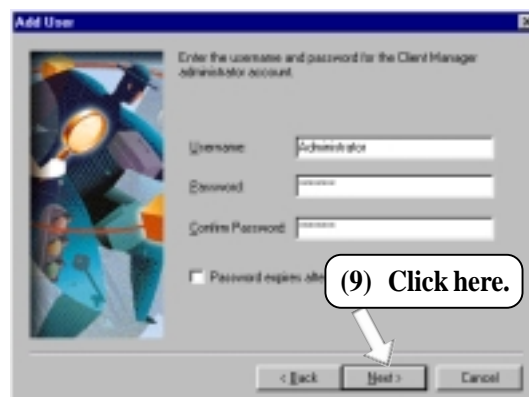
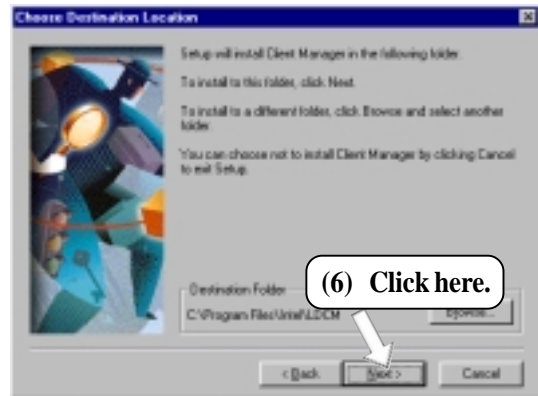
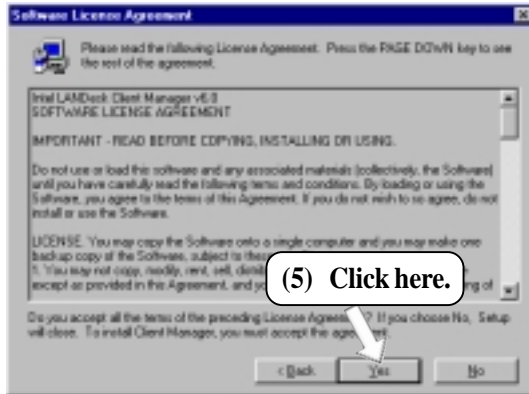

# 5. SOFTWARE SETUP

## 5.5 LDCM Administrator Setup

### System Requirements

- Intel® Pentium® microprocessor or higher.
- Operating system: Microsoft Windows 95 (can be OEM Service Release 2), or Windows 98, or Windows NT 4.0 (Service Pack 4 or later).
- Microsoft Internet Explorer 4.01 or higher.
- Memory: 16 MB of RAM for Windows 95/98; 24 MB of RAM for Windows NT (32 MB recommended).
- Disk storage space: 100 MB of available hard disk space to install; 40-100 MB of available hard disk space to run (depending on cluster size).
- Hardware system: DM or SM BIOS is required for full LDCM functionality.
- Protocols: IP (Winsock-enabled) communication protocol loaded on the client. An IP stack is required on the client, regardless of whether the client accesses the network.
- Monitor resolution of 600x800, 256 colors or greater.

Insert the Support CD that came with your motherboard into your CD-ROM drive or double-click the CD drive icon in **My Computer** to bring up the setup screen.

**NOTE:** LDCM will not run if another hardware monitoring utility, such as ASUS PC Probe, is installed. To uninstall any program, see **5.10 Uninstalling Programs**.

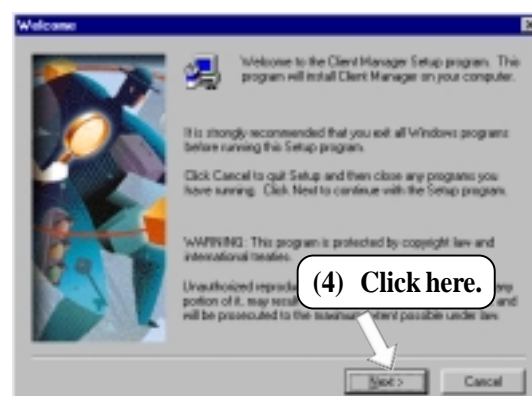
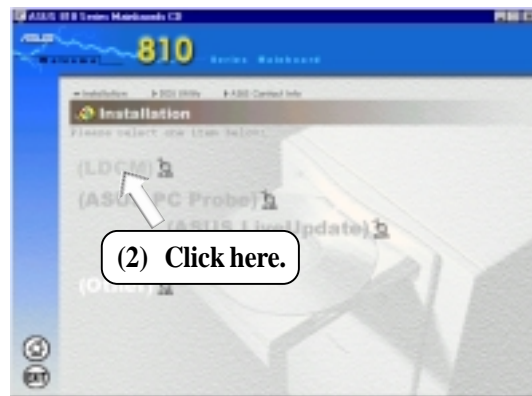

# 5. SOFTWARE SETUP

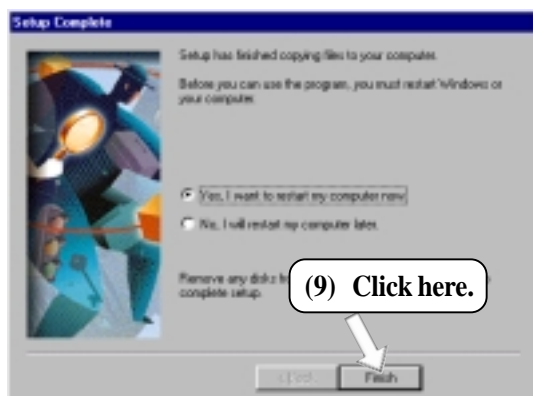
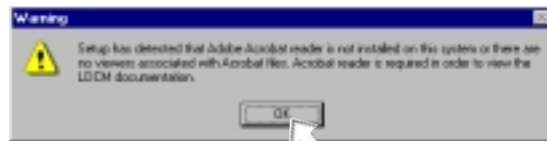
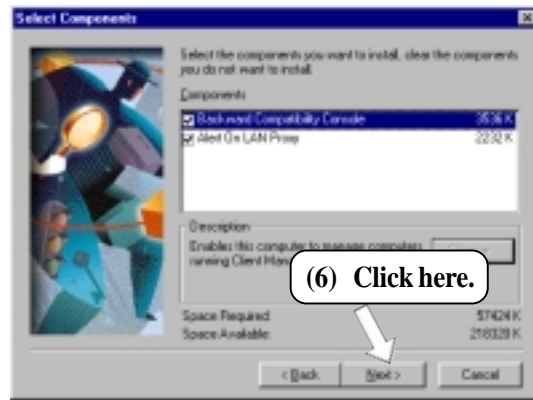
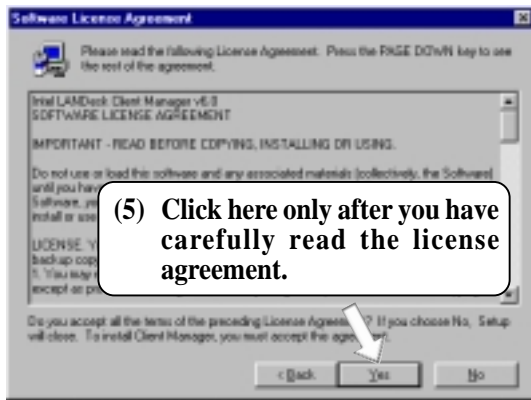



# 5. SOFTWARE SETUP

## 5.6 ASUS PC Probe

Insert the Support CD that came with your motherboard into your CD-ROM drive or double-click the CD drive icon in **My Computer** to bring up the setup screen.

**NOTE:** ASUS PC Probe will not run if another hardware monitoring utility, such as LDCM, is installed. To uninstall any program, see **5.10 Uninstalling Programs**.

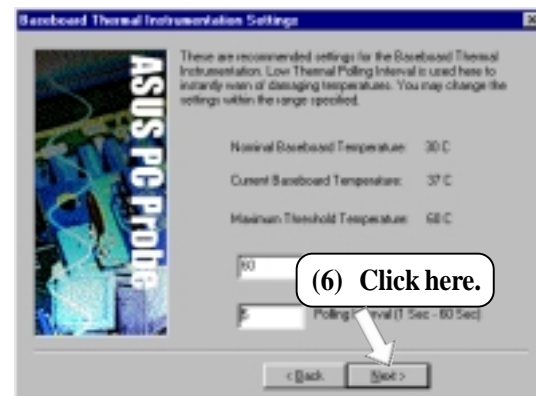
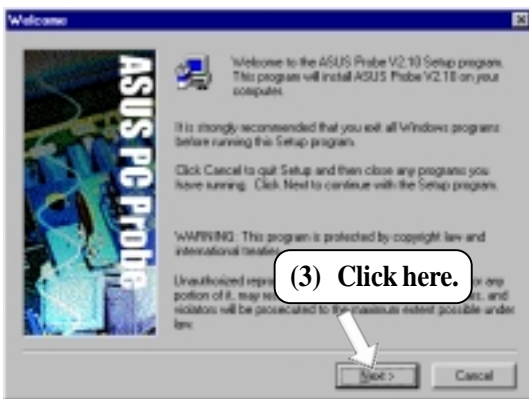
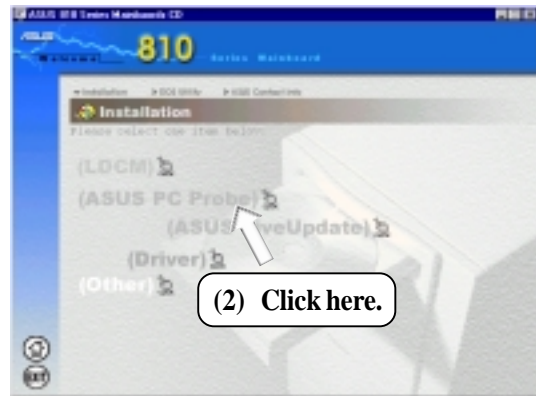
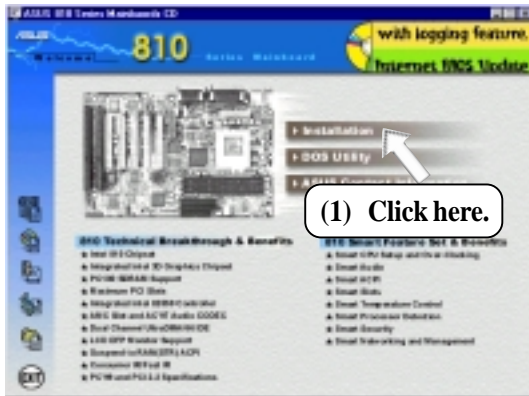

# 5. SOFTWARE SETUP

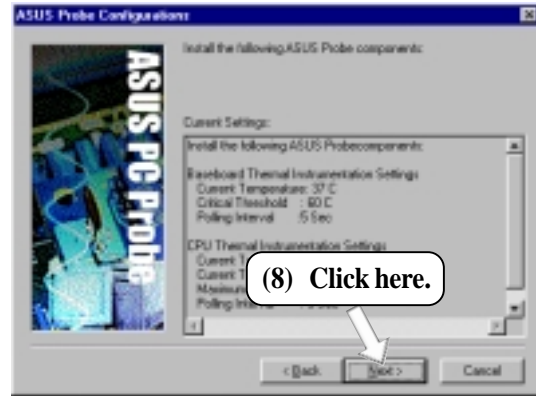
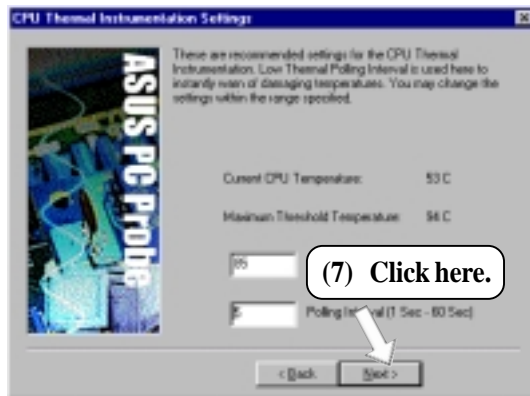

# 5. SOFTWARE SETUP

## 5.7 ASUS LiveUpdate

Insert the Support CD that came with your motherboard into your CD-ROM drive or double-click the CD drive icon in **My Computer** to bring up the setup screen.

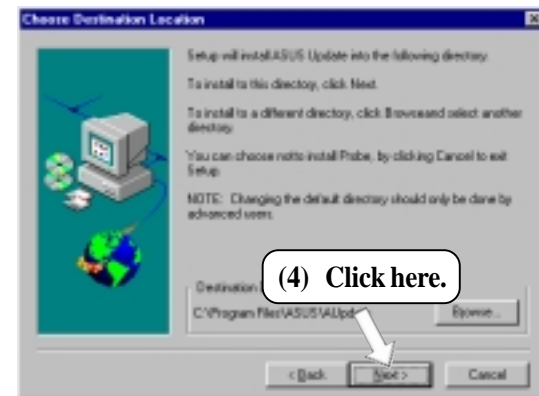
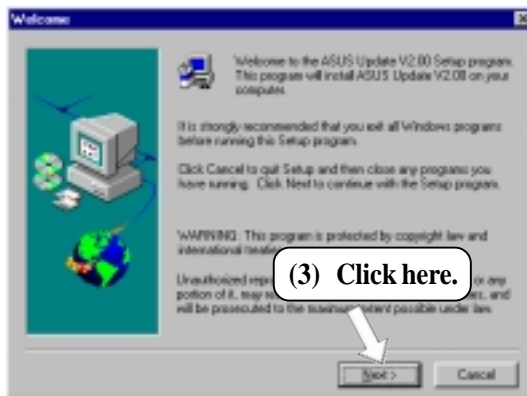
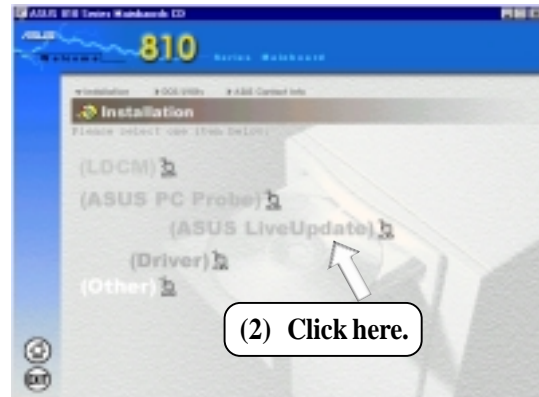



# 5. SOFTWARE SETUP

## 5.8 Drivers

### 5.8.1 VGA Driver Setup

Insert the Support CD that came with your motherboard into your CD-ROM drive or double-click the CD drive icon in **My Computer** to bring up the setup screen.

**NOTE:** Before you install the VGA driver, make sure that the INF Update Utility is installed (see *5.9.1 INF Update Utility for 810 Chipset*)

(1) Click here.

(2) Click here.

(3) Click here.

(4) Click here.

(5) Click here.

(6) Click here.

(7) Click here.

(8) Browse to E:\VGA\WIN98 and then click here.

(9) To install other drivers or software, click here, and then click *Finish*.

5. SAW SETUP  
Windows 98

# 5. SOFTWARE SETUP

## 5.8.2 Audio Driver Setup

Insert the Support CD that came with your motherboard into your CD-ROM drive or double-click the CD drive icon in **My Computer** to bring up the setup screen.

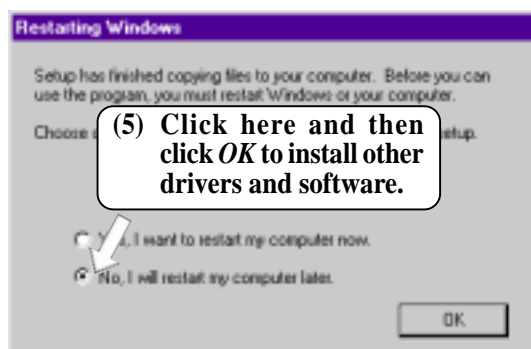
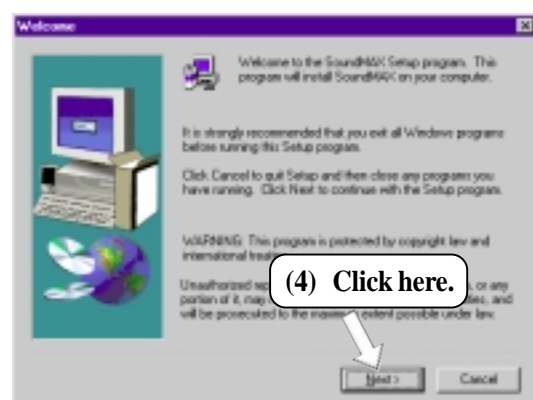
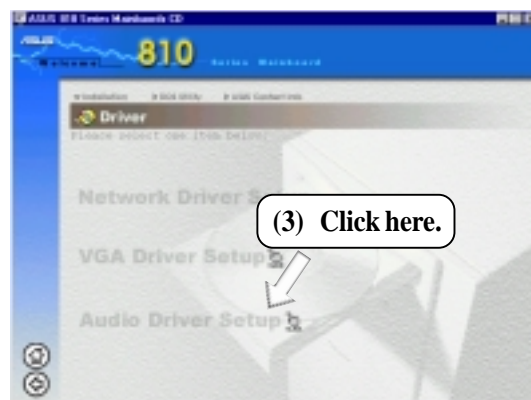
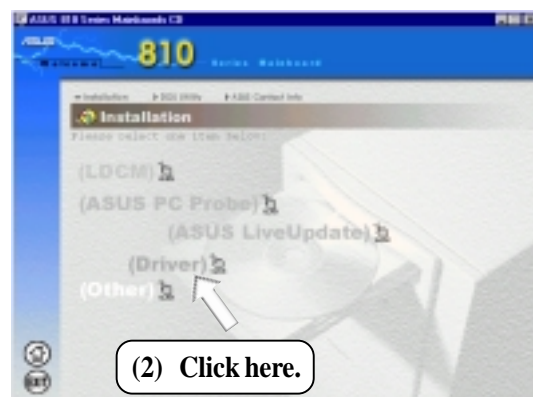

# 5. SOFTWARE SETUP

## 5.9 Other

### 5.9.1 INF Update Utility for 810 Chipset

**NOTE:** If you are using Windows 98 SE, you can skip this installation procedure.

Insert the Support CD that came with your motherboard into your CD-ROM drive or double-click the CD drive icon in **My Computer** to bring up the setup screen.

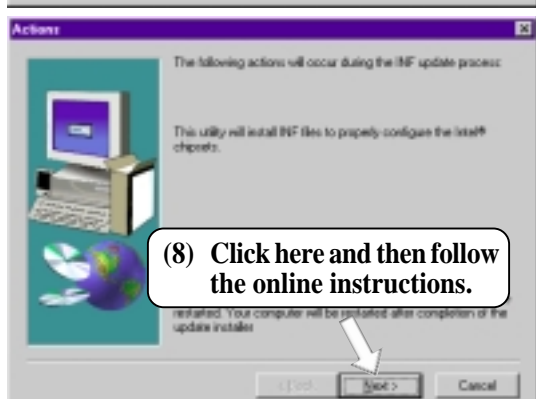
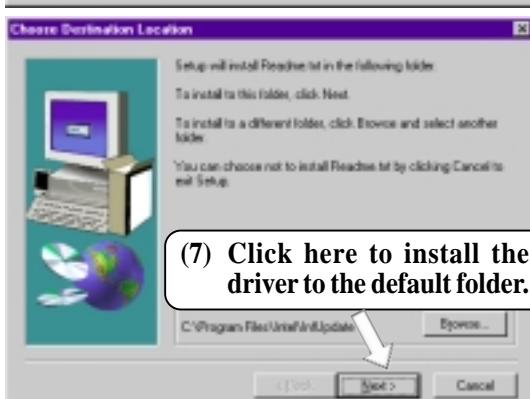
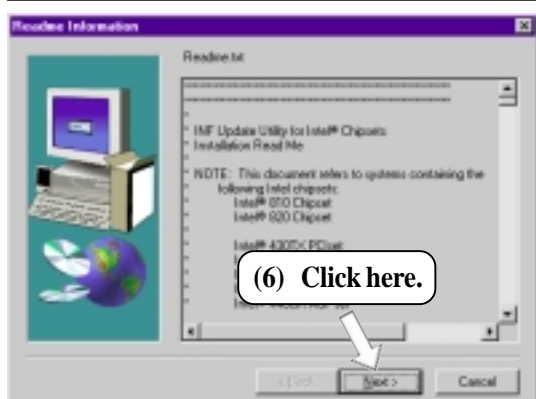
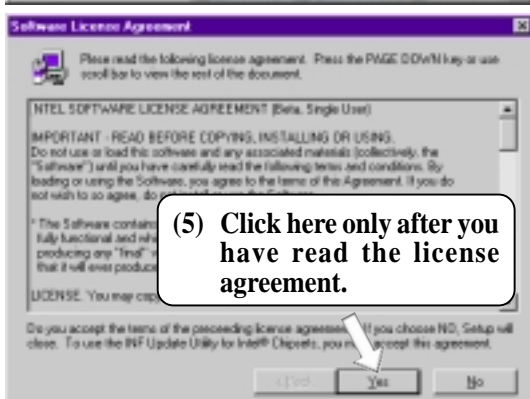
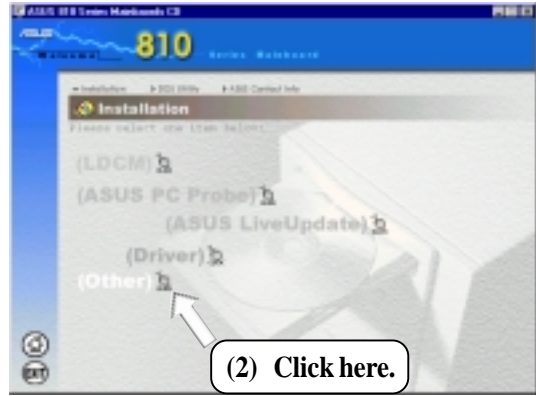

5. SW SETUP  
Windows 98



# 5. SOFTWARE SETUP

## 5.9.2 Intel Security Driver

Insert the Support CD that came with your motherboard into your CD-ROM drive or double-click the CD drive icon in **My Computer** to bring up the setup screen.

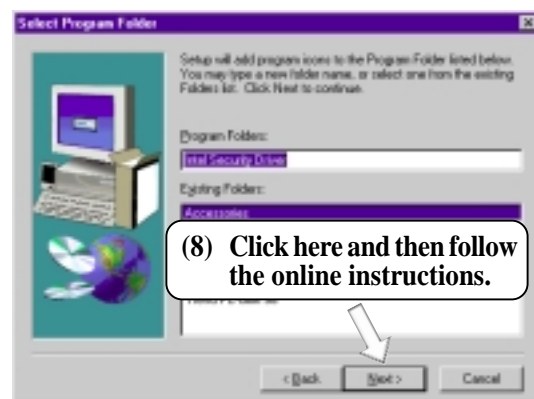
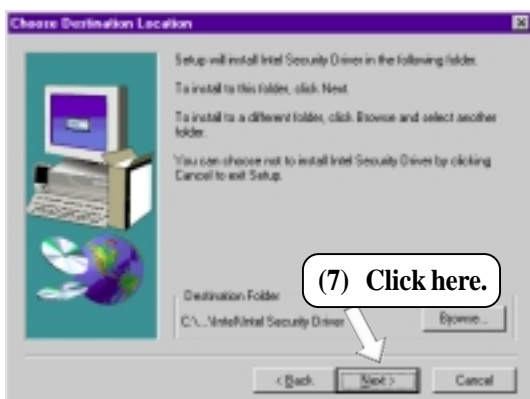
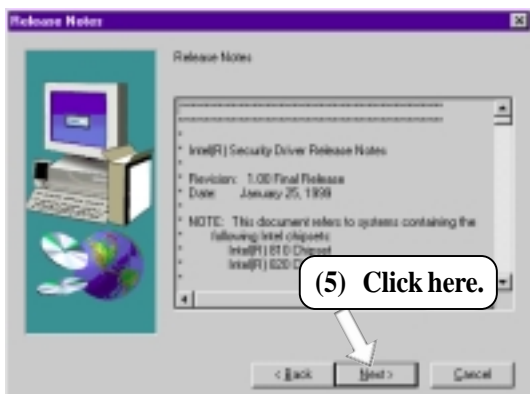
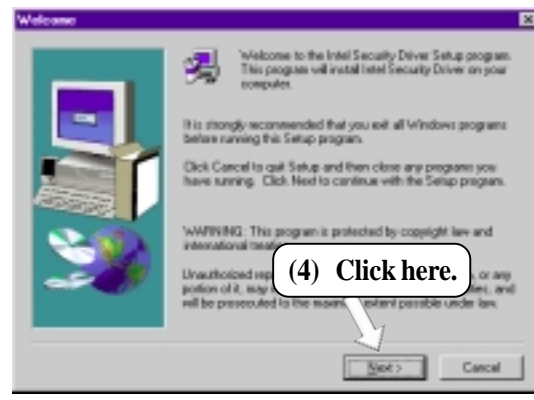
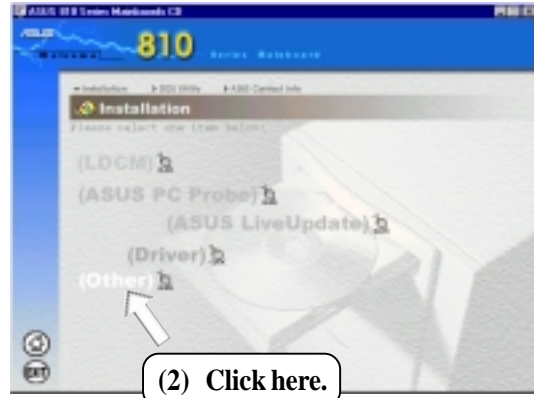
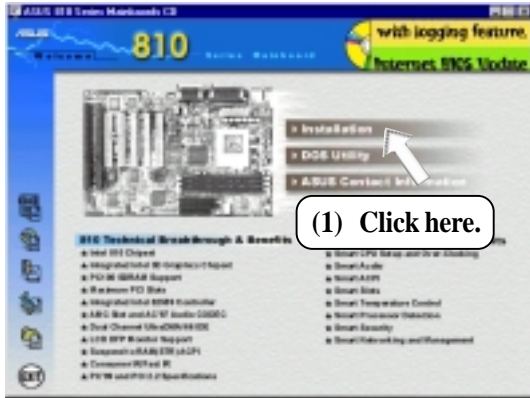

# 5. SOFTWARE SETUP

## 5.9.3 YAMAHA S-YXG50

Insert the Support CD that came with your motherboard into your CD-ROM drive or double-click the CD drive icon in **My Computer** to bring up the setup screen.

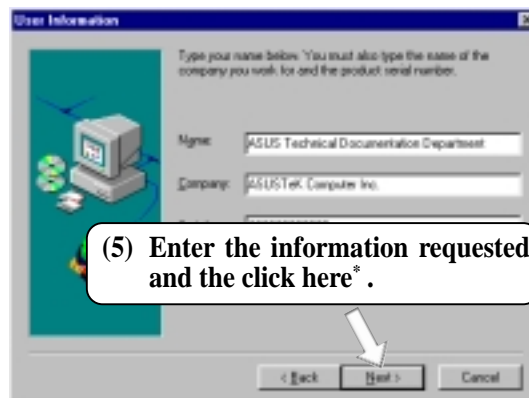
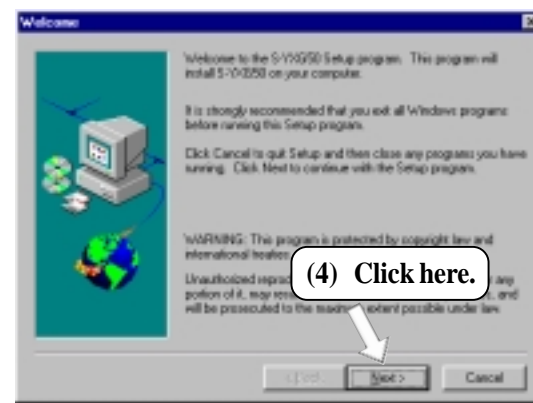
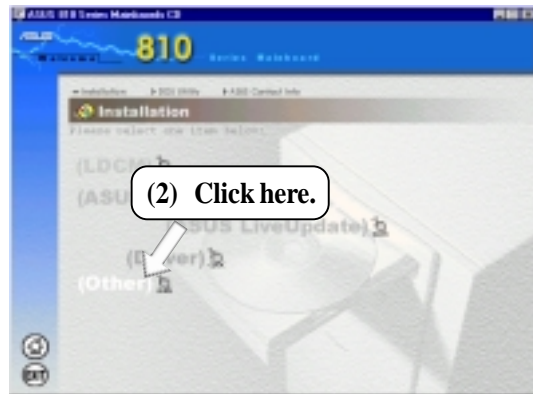
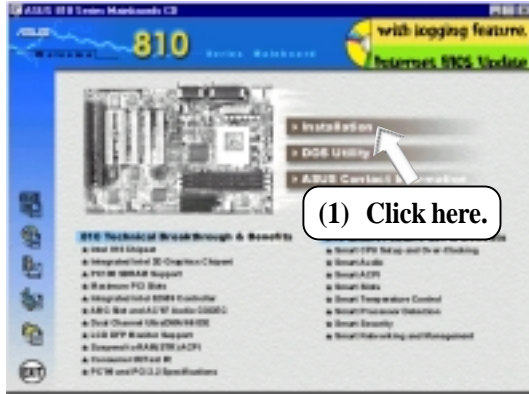

\* The serial number can be found on the software license agreement card.

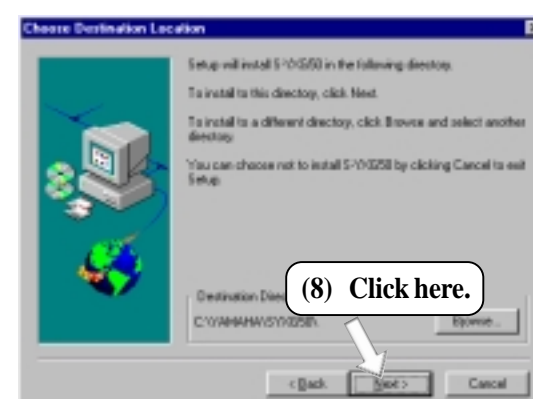
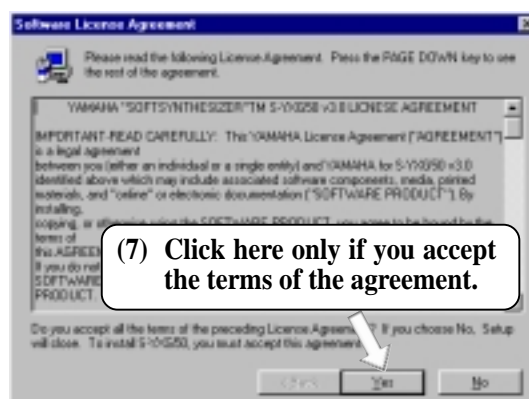

5. SW SETUP  
Windows 98

# 5. SOFTWARE SETUP

---



(9) Click here.



(10) Click here.

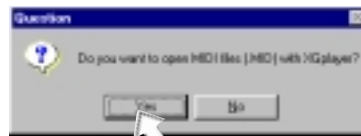

(11) Click here.

# 5. SOFTWARE SETUP

## 5.9.4 YAMAHA XGStudio

Insert the Support CD that came with your motherboard into your CD-ROM drive or double-click the CD drive icon in **My Computer** to bring up the setup screen.

(1) Click here.

(2) Click here.

(3) Click here.

(4) Click here.

(5) Click here only after you have carefully read the license agreement.

(6) Click here.

(7) Click here.

(8) Click here.

(9) Click here.

5. SW SETUP  
Windows 98



# 5. SOFTWARE SETUP

## 5.9.5 Microsoft DirectX 6.0 Driver

Insert the Support CD that came with your motherboard into your CD-ROM drive or double-click the CD drive icon in **My Computer** to bring up the setup screen.

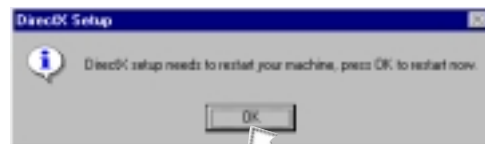
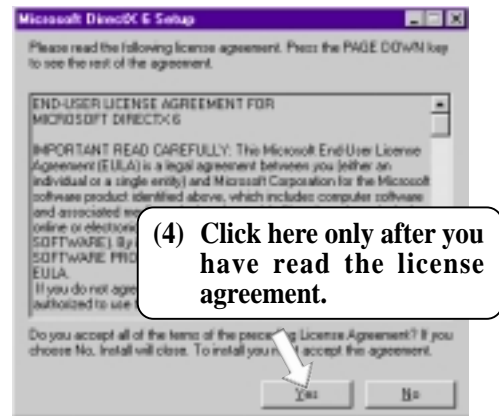
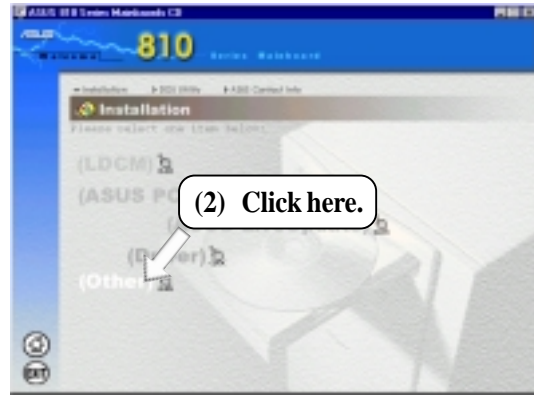
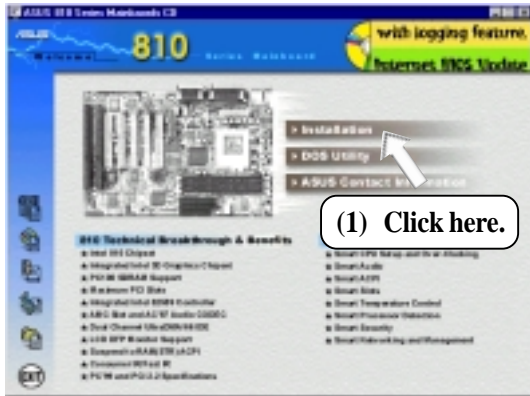



# 5. SOFTWARE SETUP

## 5.9.6 PC-cillin 98

Insert the Support CD that came with your motherboard into your CD-ROM drive or double-click the CD drive icon in **My Computer** to bring up the setup screen.

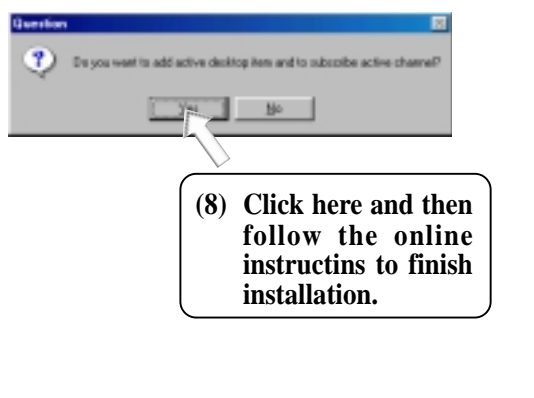
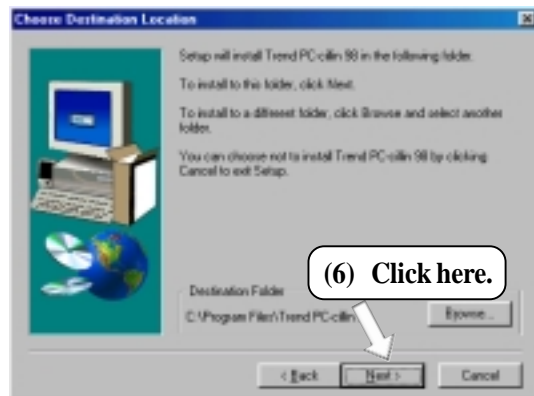
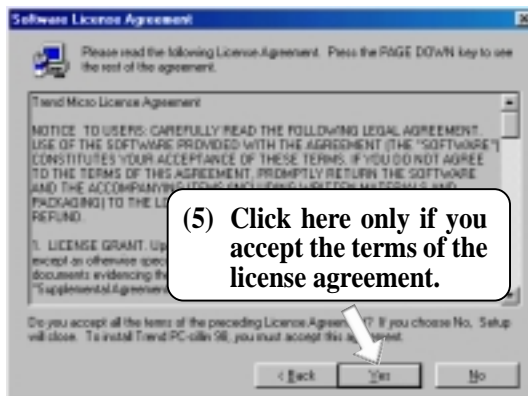
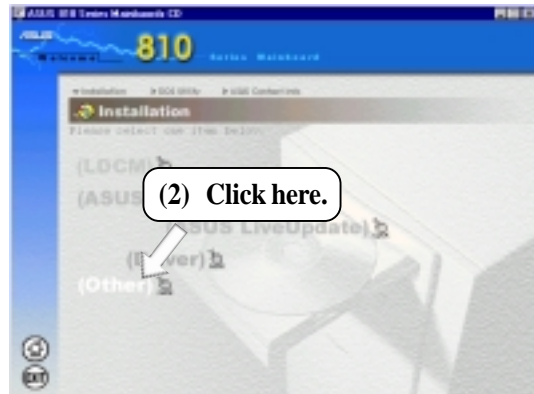
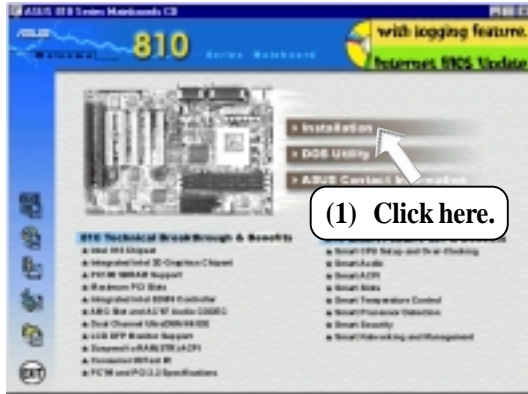

# 5. SOFTWARE SETUP

## 5.9.7 Adobe Acrobat Reader V4.0

Insert the Support CD that came with your motherboard into your CD-ROM drive or double-click the CD drive icon in **My Computer** to bring up the setup screen.

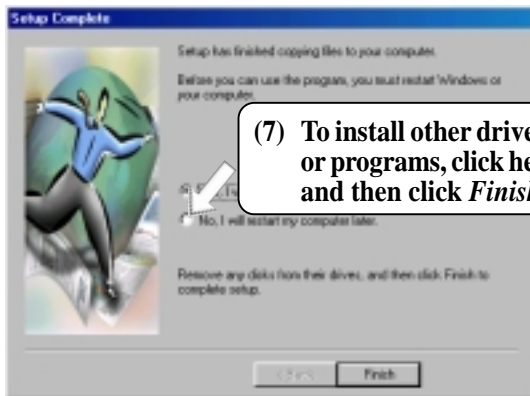
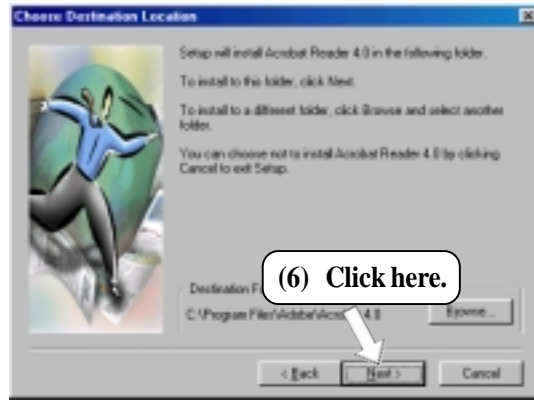
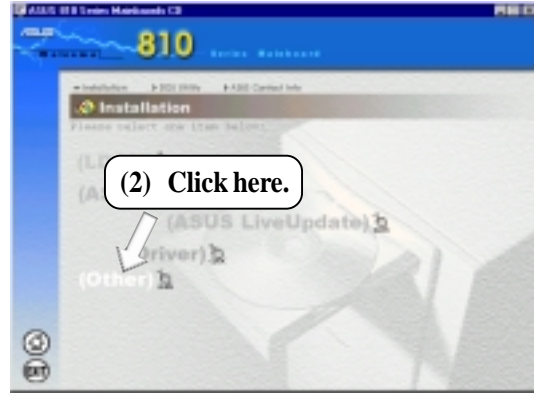

# 5. SOFTWARE SETUP

## 5.10 Uninstalling Programs

Add/Remove Programs is a basic component within Windows. You may use this function if a program does not provide its own uninstall program.

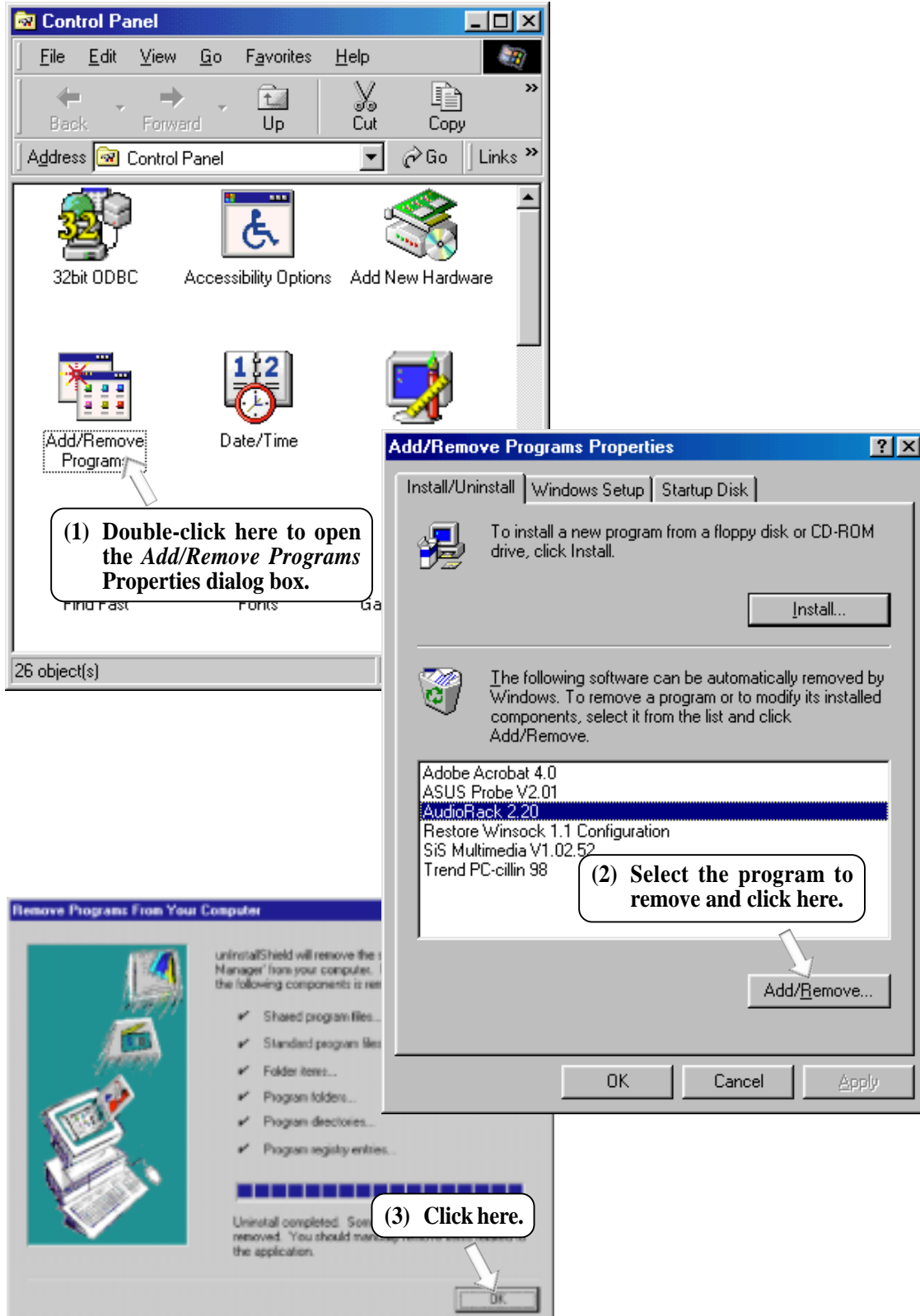

# 5. SOFTWARE SETUP

---

(This page was intentionally left blank.)

# 6. SOFTWARE REFERENCE

## 6.1 Display Properties

The motherboard's built-in 2D/3D AGP VGA supports professional graphics design, gaming, learning, and business applications.

**NOTE:** Depending on your system configuration, components, and options, your system may not show all of the settings displayed in the following pictures.

To open the Properties dialog box, right-click the desktop and select **Properties**, the **Settings** tab, and then the **Advanced** button.

### General

The **Display** box displays the current font size of the selected monitor. To use a different font size, click the arrow, and then click the font size you want.

The **Compatibility** box allows you to specify when to apply changes to system color settings. **NOTE:** Some programs might not display colors correctly without being restarted after you make changes. To avoid this problem, close the program, change the color settings, and then open the program again.

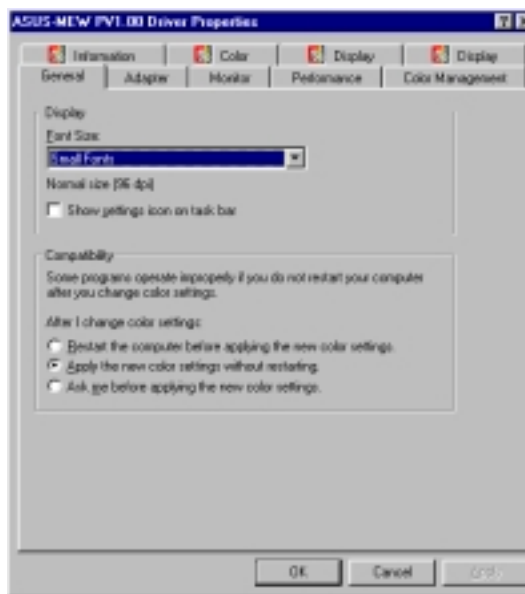

### Adapter

Shows what type of display adapter you are currently using. To install the software for a new display adapter, click **Change**.



## 6. SOFTWARE REFERENCE

### *Monitor*

Shows what type of monitor you are currently using. To install the software for a new monitor, click **Change**.

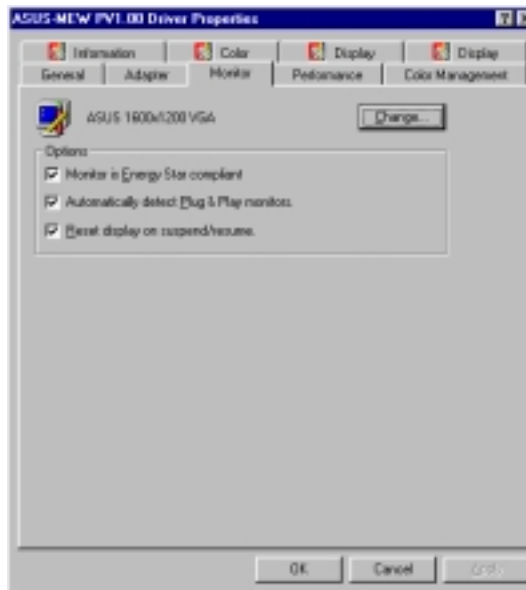

### *Performance*

Specifies the degree of acceleration you want for your graphics hardware. Full acceleration is the fastest and is recommended for most computers. If your computer is having problems and you suspect graphics acceleration to be the cause, use the highest setting at which you do not have problems.

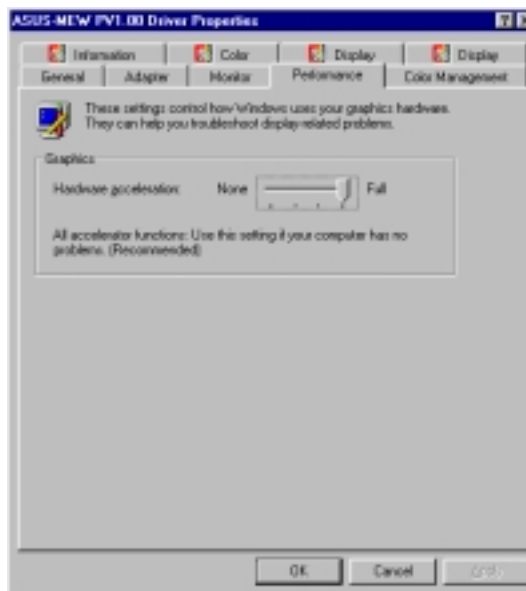

### *Color Management*

Lists all the color profile currently associated with your monitor. Click a profile to make it the active profile. Otherwise, the default profile is the active profile.

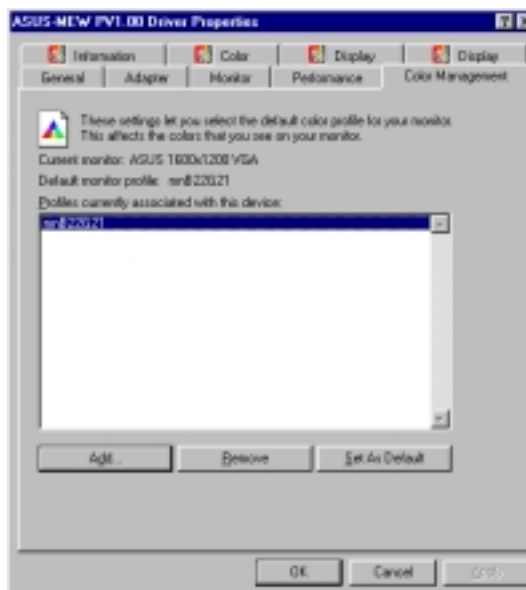



# 6. SOFTWARE REFERENCE

## Information

Gives information on your graphics device such as chipset, memory, BIOS, and drivers. Internet links are also available for easy access to the ASUS Web page for new updated drivers and notices.



## Color (Desktop)

Allows you to adjust the quality of your display according to your preference. Gamma correction is available only in 16-bit color and 24-bit color (true color, 16.7M-color) modes. In 16-color and 8-bit color (standard color, 256-color) modes, the gamma correction function is not supported.



## Color (Direct3D/Game)

This is the same as the color adjustments for the desktop but this applies to direct3D applications and games.

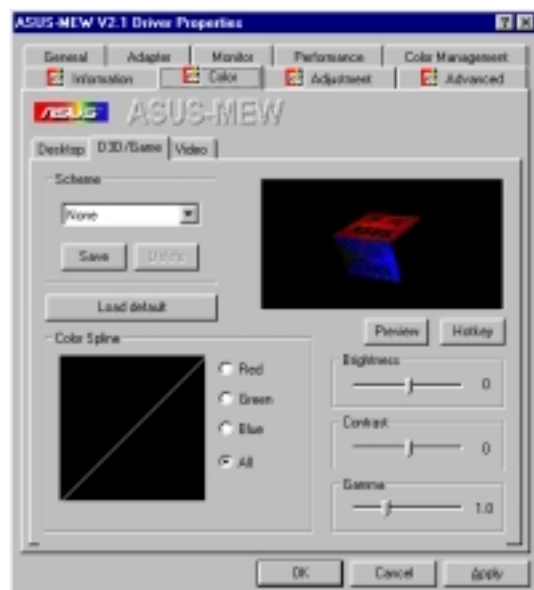

# 6. SOFTWARE REFERENCE

## Color (Video)

Lets you make color settings for videos.



## Adjustment

Allows you to adjust the display position, size, and refresh rate.

### Change refresh rate

Allows you to adjust the default refresh rates for each resolution and color settings.

### Change current refresh rate

Allows you to adjust the currently displayed resolution refresh rate.

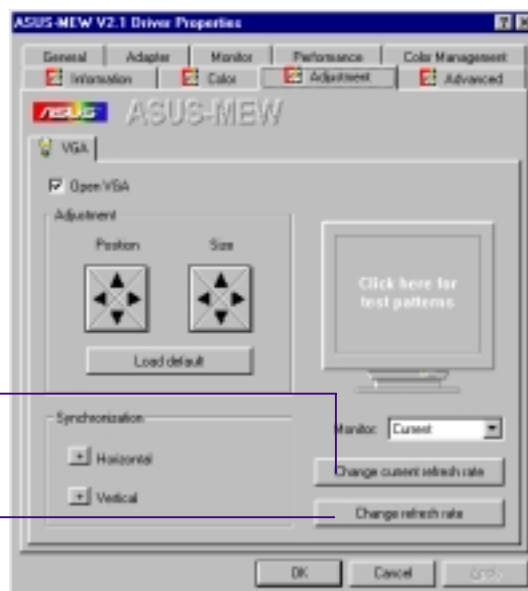

## Advanced

Allows you to assign hot keys to enable the **OnScreen Display (OSD)**. To use this function, select **Enable OSD**. You may want to change the default hot key (CTRL+ALT+O) if it conflicts with the hot keys of other games, video players, or Windows programs.





## 6. SOFTWARE REFERENCE

### 6.2 ASUS PC Probe

ASUS PC Probe is a convenient utility to continuously monitor your computer system's vital components, such as fan rotations, Voltages, and temperatures. It also has a utility that lets you review useful information about your computer, such as hard disk space, memory usage, and CPU type, CPU speed, and internal/external frequencies through the DMI Explorer.

#### 6.2.1 Starting ASUS PC Probe

When ASUS PC Probe starts, a splash screen appears allowing you to select whether or not to show the screen the next time you open PC Probe. To bypass this startup screen, clear the **Show up in next execution** check box.

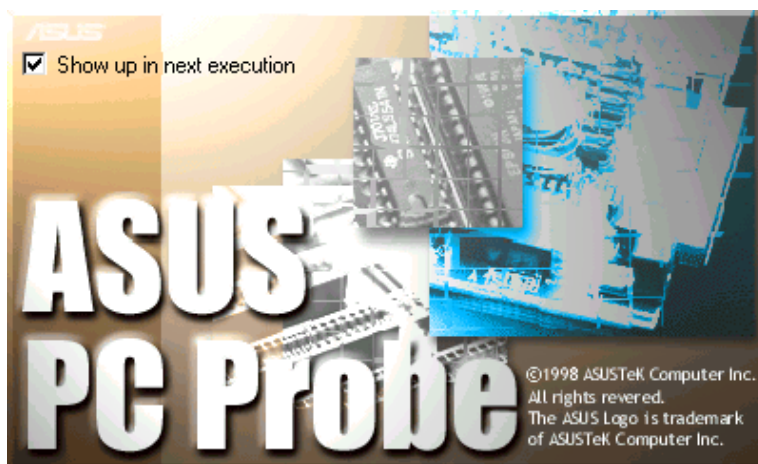

To open **ASUS PC Probe**, click the Windows **Start** button, point to **Programs**, and then **ASUS Utility**, and then click **Probe Vx.xx**.

The PC Probe icon  will appear on the taskbar's system tray indicating that ASUS PC Probe is running. Clicking the icon will allow you to see the status of your PC.



# 6. SOFTWARE REFERENCE

## 6.2.2 Using ASUS PC Probe Monitoring

### Monitor Summary

Shows a summary of the items being monitored.



### Temperature Monitor

Shows the PC's temperature.

Temperature Warning threshold adjustment  
(Move the slider up to increase the threshold level or down to decrease the threshold level)

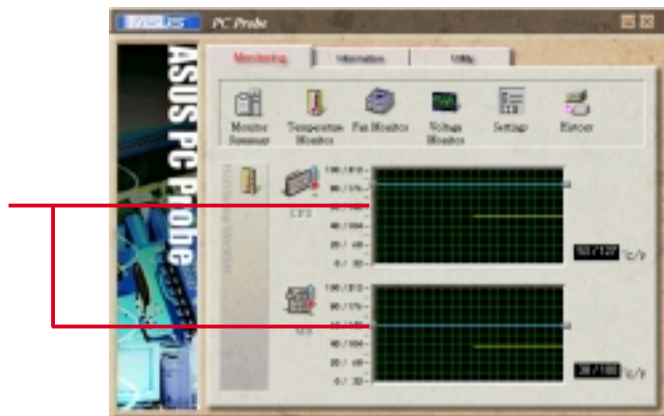

### Fan Monitor

Shows the PC's fan rotation.

Fan Warning threshold adjustment  
(Move the slider up to increase the threshold level or down to decrease the threshold level)

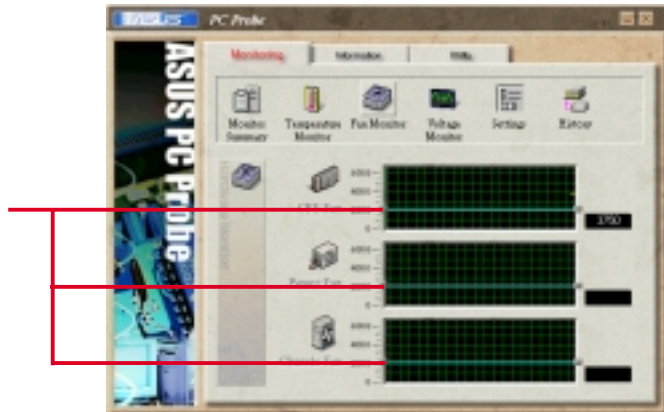

### Voltage Monitor

Shows the PC's voltages.



# 6. SOFTWARE REFERENCE

## Settings

Lets you set threshold levels and polling intervals or refresh times of the PC's temperature, fan rotation, and voltages.



## CPU Cooling System Setup

Lets you select when to enable software CPU cooling. When **When CPU Overheated** is selected, the CPU cooling system is enabled whenever the CPU temperature reaches the threshold value.



## History

Lets you record the current monitoring activity of a certain component of your PC for future reference.



## Information

### Hard Drives

Shows the used and free space of the PC's hard disk drives and the file allocation table or file system used.



# 6. SOFTWARE REFERENCE

## Memory

Shows the PC's memory load, memory usage, and paging file usage.



## Device Summary

Shows a summary of devices in your PC.



## DMI Explorer

Shows information pertinent to the PC, such as CPU type, CPU speed, and internal/external frequencies, and memory size.



## Utility

Lets you run programs outside of the ASUS Probe modules. To run a program, click **Execute Program**.





# 6. SOFTWARE REFERENCE

## 6.2.3 ASUS PC Probe Task Bar Icon

Right-clicking the PC Probe icon will bring up a menu to open or exit ASUS PC Probe and pause or resume all system monitoring.



When the ASUS PC Probe senses a problem with your PC, portions of the ASUS PC Probe icon changes to red, the PC speaker beeps, and the ASUS PC Probe monitor is displayed.

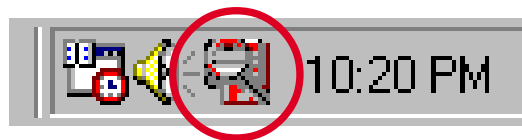

# 6. SOFTWARE REFERENCE

## 6.3 ASUS LiveUpdate

ASUS LiveUpdate is a utility that allows you to update your motherboard's BIOS and drivers. The use of this utility requires that you are properly connected to the Internet through an **Internet Service Provider (ISP)**.

1. Start ASUS Update V2.00.

Launch the utility from **Start | Programs | ASUS Utility | ASUS LiveUpdate V1.00**.

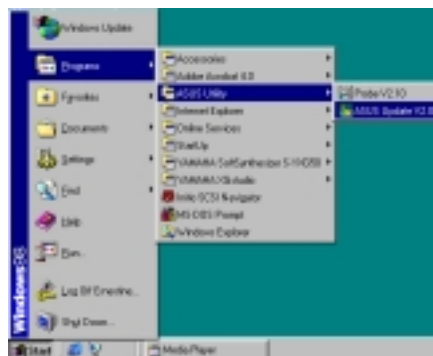

2. Select an update method.



3. If you selected updating/downloading from the Internet, you will need to select an Internet site. Choose the site that is closest to you or click **Auto Select**.



If you selected **Update from a file**, you will be prompted to locate the file.

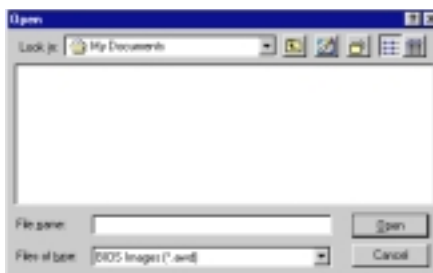

# 6. SOFTWARE REFERENCE

## 6.4 Using Yamaha XGstudio Player

To start the Yamaha XGstudio, click **Start**, point to **Programs**, point to **YAMAHA XGstudio**, and then click **XGstudio Player**.

### 6.4.1 Yamaha XGstudio Player Control Panel



Closes the player. **NOTE:** You can also close the player by pressing <Alt>+<F4>.



Minimizes the player to an icon.



Displays the *Set Play List* dialog box where you can create a list of songs to play automatically. **NOTE:** You can also display the *Set Play List* dialog box by pressing <Ctrl>+<O>.



Loads and plays the MIDO file currently selected in *Play List*. When all the songs in the *Play List* have finished, playing stops automatically and the song at the beginning of the list is designated as the current-play song.



Pauses the playing of a song. Click this button again or click  to resume playing.



Stops the playing of a song and returns the start-play location to the beginning of the song.



Designates the first song in the *Play List* as the new current-play song.



Designates the song just before the currently playing song as the new current-play song.



Designates the song after the song currently playing as the new current-play song.



Designates the last song in the *Play List* as the new current-play song.



Displays the control panel for the Soft Synthesizer features.



Speeds up the tempo of the song being played.



Slows down the tempo of the song being played.

**NOTE:** The tempo is reset to 0 for each new song.



Displays the *Set Sound Source* dialog box.



Displays Help. **NOTE:** You can also display Help by pressing <F1>.



Increases/decreases the volume level of the song being played by dragging the slider up/down.

**For detailed instructions and references to software and utilities, use the programs' online help and electronic documentations.**

## 6. SOFTWARE REFERENCE

### 6.5 Using Yamaha XGstudio Mixer

To start the Yamaha XGstudio, click **Start**, point to **Programs**, point to **YAMAHA XGstudio**, and then click **XGstudio Mixer**.

#### 6.5.1 Yamaha XGstudio Mixer Control Panel

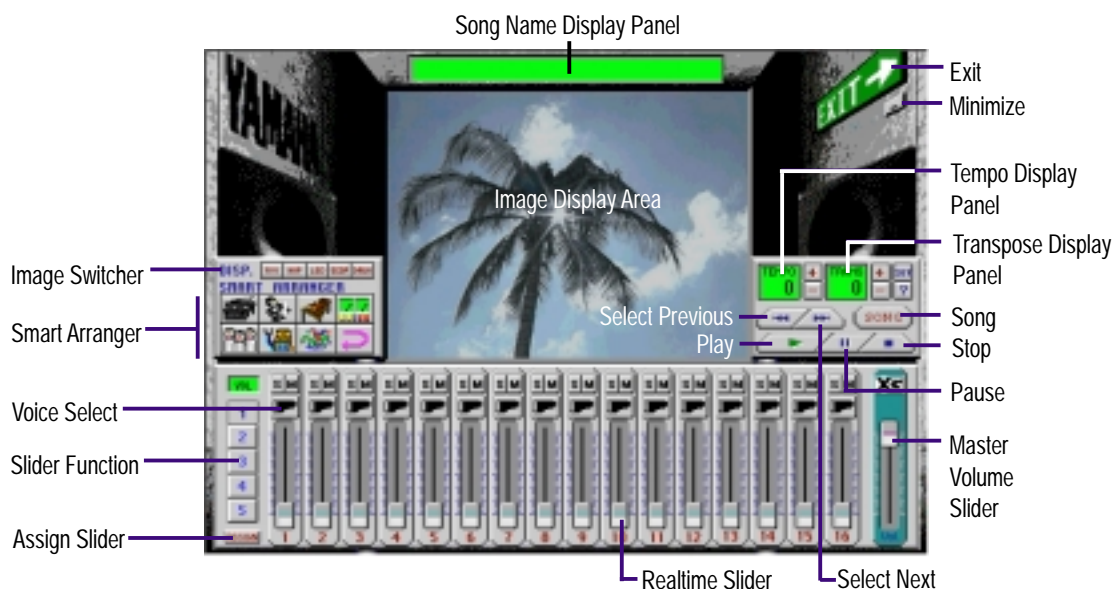

#### Image Switcher



##### (AVI file): Video image

Displays the AVI file with the same name as the MIDI file being played. If one is not available, the preset **DEFAULT.AVI** file is played.



##### (BMP file): Still image

Displays the BMP file with the same name as the MIDI file being played. If one is not available, the preset **DEFAULT.BMP** file is played



##### (LED velocity meter): Animation

Displays the volume (amount of velocity) of each MIDI channel.



##### (SCOPE velocity meter): Animation

Displays the volume (amount of velocity) of each MIDI channel graphically in a radio chart.



##### (drum and percussion): Animation

Displays animation with lights that match the drums and percussion used in the drum channel (10ch).



# 6. SOFTWARE REFERENCE

---

## Smart Arranger

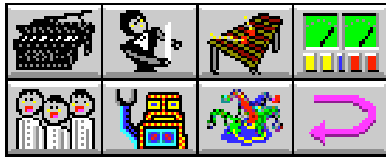

The Smart Arranger allows you to easily change the mood of a song. You can switch between seven ensemble voice sets with these buttons. To return to the original voice set, click .



Piano



Orchestra



Mallet

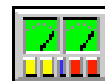

Techno

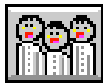

Choir



Robot



Nature



Return

# 6. SOFTWARE REFERENCE

## 6.6 Hardware Information

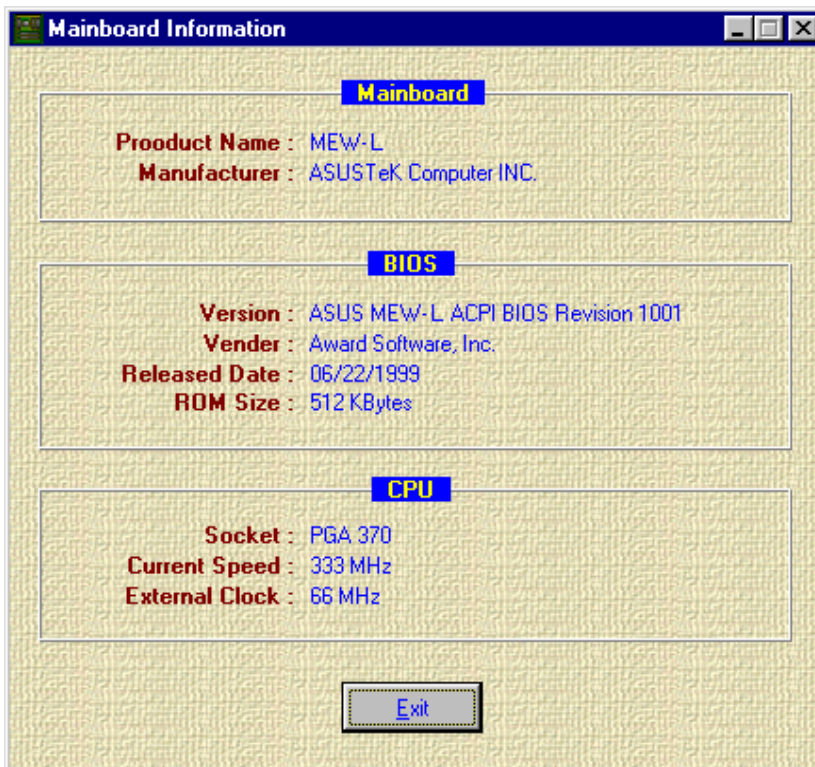

# 7. APPENDIX

## 7.1 PCI-L101 Fast Ethernet Card

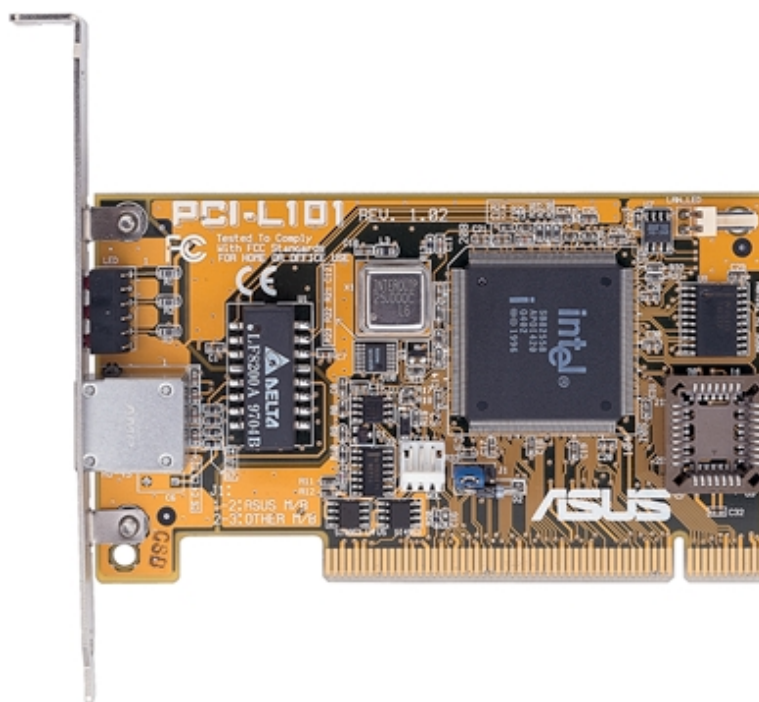

7. APPENDIX  
ASUS LAN Card

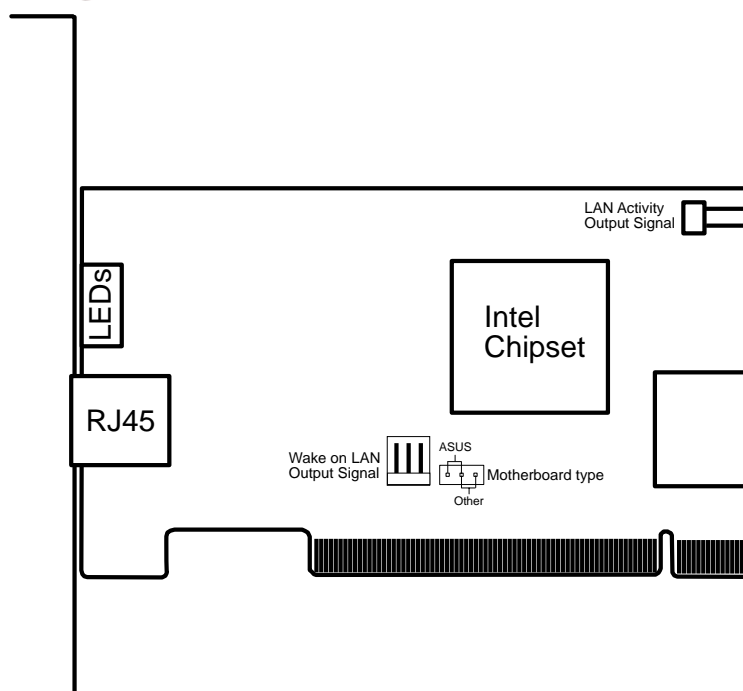

If you are using the ASUS PCI-L101 on an ASUS motherboard, leave the jumper on its default setting of “ASUS.” If you are using another brand of motherboard, set the jumper to “Other.” Connect the Wake on LAN (WOL) output signal to the motherboard’s WOL\_CON in order to utilize the wake on LAN feature of the motherboard. Connect the LAN activity output signal (LAN\_LED) to the system cabinet’s front panel LAN\_LED in order to display the LAN data activity.

# 7. APPENDIX

---

## 7.1.1 Features

- Intel 82558 Ethernet LAN Controller (Fully integrated 10BASE-T/100BASE-TX)
- Wake-On-LAN Remote Control Function Supported
- PCI Bus Master Complies to PCI Local Bus Rev. 2.1 specifications
- Consists of MAC & PHY (10/100Mbps) interfaces
- Complies to IEEE 802.3 10BASE-T and IEEE 802.3u 100BASE-TX interfaces
- Fully supports 10BASE-T & 100BASE-TX operations through a single RJ45 port
- Supports 32-bit Bus Master Technology / PCI Rev. 2.1
- Enhancements on ACPI & APM
- Adheres to PCI Bus Power Management Interface Rev. 1.0, ACPI Rev. 1.0, and Device Class Power Management Rev. 1.0
- IEEE 802.3u auto-negotiation for 10Mbps/100Mbps Network Data Transfer Rates.
- Provides LED indicators for monitoring network conditions
- Plug and Play

## 7.1.2 Software Driver Support

- **NetWare ODI Drivers** - Novell Netware 3.x, 4.x, DOS, OS/2 Client
- **NDIS 2.01 Drivers** - Microsoft LAN Manager, Microsoft Windows 3.11, IBM LAN Server
- **NDIS 3.0 Drivers** - Microsoft Windows NT, Microsoft Windows 95, Microsoft Windows 3.11

## 7.1.3 Question and Answer

Q: What is Wake-On-LAN ?

A: The Wake-On-LAN feature provides the capability to remotely power on systems supporting Wake-On-LAN by simply sending a wake-up frame. With this feature, remotely uploading/downloading data to/from systems during off-peak hours will be feasible.

Q: What can Wake-On-LAN do for you ?

A: Wake-On-LAN is a remote management tool with advantages that can reduce system management workload, provide flexibility to the system administrator's job, and then of course save you time-consuming efforts and costs.

Q: What components does Wake-On-LAN require to be enable?

A: To enable Wake-On-LAN function, your system requires Ethernet LAN adapter card that can activate Wake-On-LAN function, a client with Wake-On-LAN capability, and software such as LDCM Rev. 3.10 or up that can trigger wake-up frame.

# 7. APPENDIX

## 7.2 S370 Series CPU Cards

The optional ASUS S370 Series CPU Cards allow Slot 1 motherboards to accept socket 370 processors. The ASUS S370 Series CPU Cards give Slot 1 motherboard owners an inexpensive way to upgrade their Pentium II computers using lower cost socket 370 processors. Since socket 370 processors are based on the Pentium II design, the only difference is the connector and the amount of internal cache within the processor.

The following are pictures of the ASUS S370 Series CPU Cards with black plastic retainers attached to the edge. The retainer fins are used to hold the ASUS S370 Series CPU Cards in place using the motherboard's Slot 1 retention mechanisms.

### ASUS S370 CPU Card (standard model)

- Better Support with Full Retainer
- Low Cost

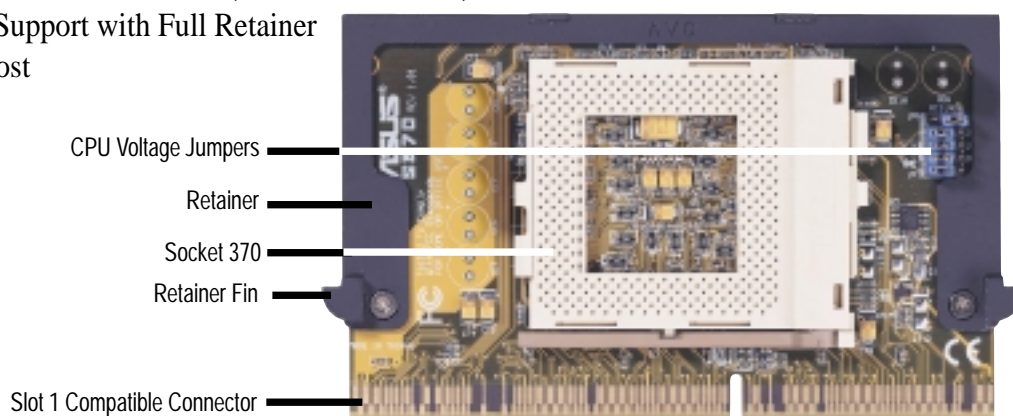

### ASUS S370-L CPU Card (for smaller cases)

- Low Profile / Low Cost
- CPU Temperature Sensing (on supported motherboards)

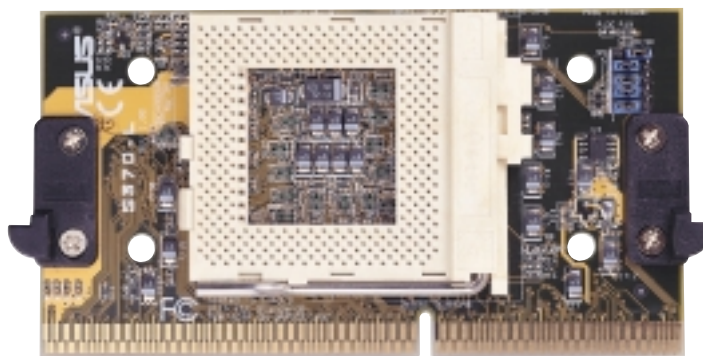

### ASUS S370-D CPU Card (performance model)

- Better Support with Full Retainer
- CPU Temperature Sensing (on supported motherboards)
- Better Components

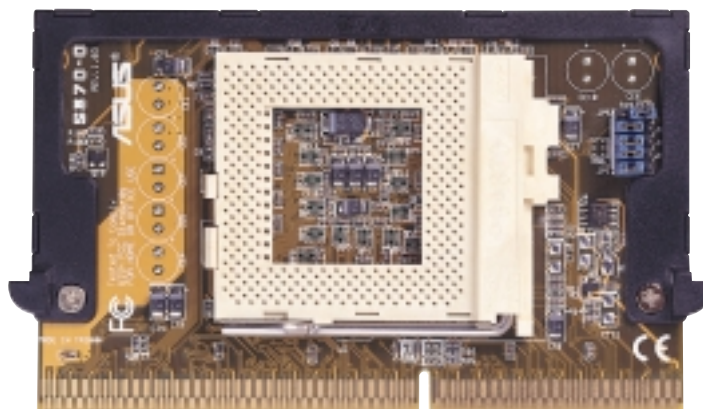



# 7. APPENDIX

## 7.2.1 Using the ASUS S370 Series CPU Card

The general procedure for using the ASUS S370 Series CPU Card is as follows:

1. Check the voltage setting for your socket 370 processor using the jumpers on the card if necessary. For current socket 370 processors, the default setting should be used. See the reverse side of the ASUS S370 Series CPU Card or this page for voltage settings.
2. Install the socket 370 processor. Installation of socket 370 processors is exactly like socket 7 processors. Lift the brown lever to 90° to install the processor and lower the brown lever to lock the processor.
3. Insert the ASUS S370 Series CPU Card into Slot 1 on the motherboard. The retainer fin on each side of the ASUS S370 Series CPU Card must catch on the retention mechanism so that it locks in place.
4. Connect the socket 370 processor's fan connector to the motherboard.
5. Make sure that no wires or objects come in contact with the fan.

## 7.2.2 S370 Series CPU Card Jumper Settings

The only set of jumpers on the ASUS S370 Series CPU Card is used for setting the voltage sent to the CPU. Setting the CPU voltage is *not* necessary for current socket 370 processors. If required, your socket 370 processor should have its voltage requirement printed on its surface or documentation. If no voltage is indicated or you are not sure, use the “CPU Def.” setting as shown below.

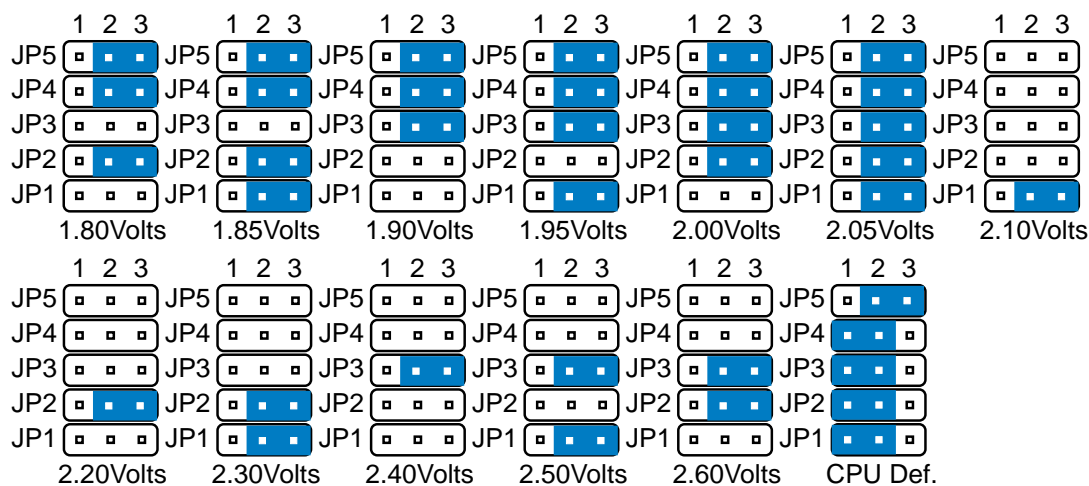

Socket 370 CPU Voltage

**WARNING!** Exceeding your socket 370 processor's required voltage can damage your processor permanently! Make sure that the jumpers are as shown for “CPU Def.” unless otherwise specified before powering ON your motherboard.

# 7. APPENDIX

## 7.3 Modem Riser

### 7.3.1 56K Software Modem

The Modem Riser (MR) is a high-speed PC communication peripheral which works with AMC'97/MC'97 compliant codecs. With this software modem, you can connect your computer to a remote location, receiving data at up to 56 Kbps in V.90 or K56flex modes.

### 7.3.2 Primary/Secondary MR

There are two types of modem risers: primary MR and secondary MR. In appearance, the primary MR has a crystal onboard but the secondary does not. If your motherboard has an audio codec and no PCI audio chipset onboard, you may use the secondary MR; otherwise, you should use the primary MR.

*Layout of Primary MR*

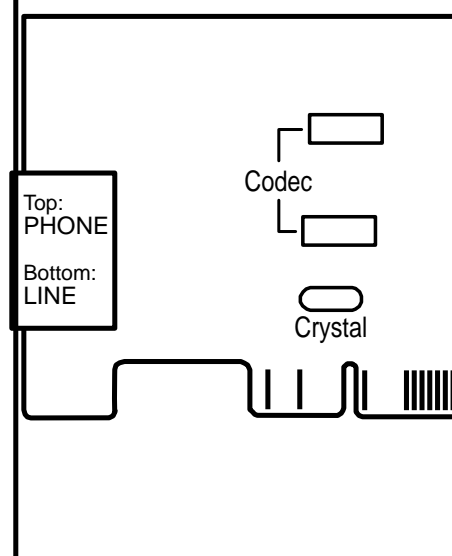

7. APPENDIX  
Modem Riser

### 7.3.3 Hardware Installation Procedure



1. Power OFF your computer.
2. Open the computer chassis and remove the metal plate on the AMR expansion slot.
3. Carefully align the MR card's connector to the AMR slot and press firmly.
4. Secure the MR card onto the chassis with the screw removed in step 2.
5. Connect the MR card's **LINE** connector to a telephone wall jack. Connect the **PHONE** connector to a telephone (optional).
6. Replace the computer chassis.

# 7. APPENDIX

## 7.3.4 Software Setup in Windows 98

The Modem Riser supports the Plug and Play feature. It allows your computer to automatically set the optimal configurations for the MR and communication software. Follow the procedure below to install the modem driver.

1. Power ON the computer after the hardware installation is completed.
2. Windows 98 will automatically detect the modem and display a “PCI Card” message under “Add New Hardware Found”.
3. Select **Search for the best driver for your device** and click **Next**.
4. Insert the Support CD that came with your motherboard into your CD-ROM drive. Enter the path **E:\Modem\Win98** (assuming that your CD-ROM drive is drive E:) for the MR driver.
5. After the driver is located, click **Next** and then click **Finish**.
6. Restart your computer. Double click the modem icon at the bottom-right corner of the window. 
7. Click the **Settings** tab. Select your country and language. Click **OK**.
9. Click **Start**, point to **Settings**, click **Control Panel**, double click **Modems**, click the **General** tab, and click **Motorola SM56 AC-L Modem**.
10. Click **Diagnostic** and then click the designated COM port as shown.
11. Click **More Info...**. If the computer system successfully communicates with the modem, responses will be displayed as shown.

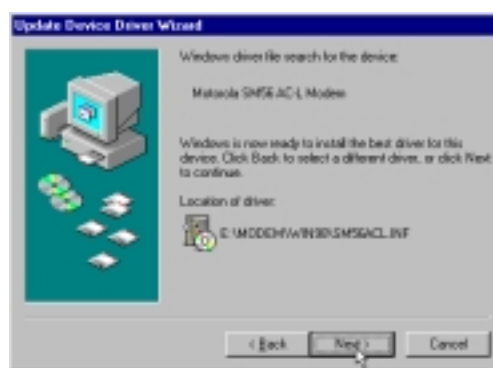
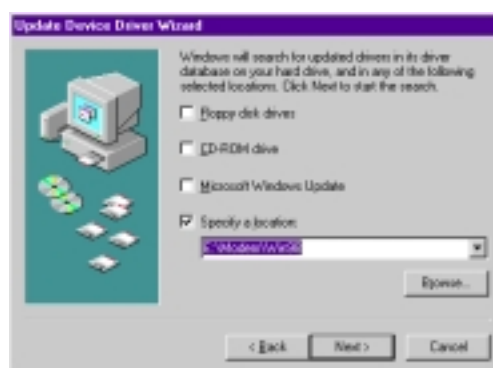



# INDEX

---

## Symbols

16-bit I/O Recovery Time 61  
8-bit I/O Recovery Time 61

## A

AC PWR Loss Restart 70  
Adobe Acrobat Reader 99  
AFLASH.EXE 46  
ASUS LiveUpdate 88  
    Setup 88  
    Using 110  
ASUS PC Probe  
    Setup 87  
    Using 105  
ATAPI CD-ROM 73  
ATX Power Supply Connector 41  
ATX Power Switch Lead 43  
Audio Modem Riser (AMR) Slot 30  
Audio Port Connectors 33  
Automatic Timeout Reboot Setting 21

## B

BIOS Advanced Menu 58  
BIOS Boot Menu 73  
BIOS Exit Menu 75  
BIOS Legend Bar 50  
BIOS Main Menu 52  
BIOS Menu Bar 50  
BIOS Power Menu 68  
BIOS Update 59  
Boot Sequence 73  
Boot Up Floppy Seek 74  
Boot Up NumLock Status 74  
Boot Virus Detection 74

## C

Central Processing Unit 26  
Chassis Fan Connector 36  
Chassis Fan Speed 72  
Chassis Intrusion Lead 41  
CHS Capacity 55  
Connectors  
    ATX Power Supply 41  
    Audio Port 33  
    Chassis Fan 36

Consumer IR 38  
CPU Fan 36  
Fast-Ethernet Port 33  
Floppy Disk Drive 34  
Internal Audio 37  
Internal Microphone 40  
Internal Speaker 37  
Joystick/MIDI 33  
Monitor Output 33  
Parallel Port 32  
Power Supply Fan 36  
Primary IDE 34  
PS/2 Keyboard 31  
PS/2 Mouse 31  
Secondary IDE 34  
Serial IR 38  
Serial Port 32  
SMBus 39  
System Warning Speaker 43  
Universal Serial Bus 32  
Wake-On-LAN 35  
Wake-On-Ring 35  
Consumer IR Connector 38  
CPU Bus Frequency (MHz) 58  
CPU Core:Bus Freq. Multiple 58  
CPU Fan Connector 36  
CPU Fan Speed 72  
CPU Frequency Setting 22  
CPU Latency Timer 61  
CPU Level 1 Cache 59  
CPU Level 2 Cache 59  
CPU Level 2 Cache ECC Check 59  
CPU Speed 58  
CPU Temperature 72  
CPU Vcore 59  
CPU/SDRAM/PCI Freq. Ratio 58  
Cylinders 54

## D

D0000-DFFFF Shadow 67  
Digital LCD Header 39  
DIMM Installation 25  
DIP switches 17  
Discard Changes 76  
DMA x Used By ISA 66

# INDEX

---

- Driver Setup
  - Audio 90
  - Intel Security 93
  - Microsoft DirectX 96
  - PCI Audio 81
  - VGA 89
- E**
- ECP DMA Select 63
- Ethernet Card 115
- Exit Discarding Changes 75
- Exit Saving Changes 75
- Expansion Card Installation Procedure 27
- Expansion Cards
  - Assigning IRQs 28
  - Audio Modem Riser 30
- External Connectors 31
- F**
- Fast-Ethernet Port Connector 33
- Flash Memory Writer Utility 46
- Floppy 3 Mode Support 52
- Floppy Disk Access Control 62
- Floppy Disk Drive Connector 34
- Full Screen Logo 74
- G**
- Graphics Window Size 61
- H**
- Halt On 57
- Hardware Information 114
- Hardware Monitor 72
- Hardware Setup Procedure 17
- HDD Power Down 69
- Head 55
- Headers
  - Digital LCD 39
  - Serial Port 38
- High Priority PCI Mode 61
- I**
- I/O Voltage Setting 19
- IDE Activity LED Lead 36
- IDE Hard Drive 73
- INF Update Utility for 810 Chipset 91
- Installed Memory 57
- Intel Security Driver 93
- Internal Audio Connectors 37
- Internal Microphone Connector 40
- Internal Speaker Connector 37
- Interrupts
  - Request Table 29
  - Standard Assignments 28
- IRQ XX Used By ISA 65
- ISA MEM Block BASE 67
- Item Checklist 7
- J**
- Joystick/MIDI Connector 33
- JumperFree™ Mode Setting 18
- K**
- Keyboard Lock Switch Lead 43
- L**
- Language 56
- LDCM Administrator Setup 84
- LDCM Client Setup 82
- Leads
  - ATX Power Switch 43
  - Chassis Intrusion 41
  - IDE Activity LED 36
  - Keyboard Lock Switch 43
  - Message LED 43
  - Reset Switch 43
  - System Management Interrupt 43
  - System Power LED 43
- Legacy Diskette A 52
- Legacy Diskette B 52
- LiveUpdate
  - Setup 88
  - Using 110
- Load Setup Defaults 76
- M**
- Managing BIOS 46
- Maximum LBA Capacity 55
- MB Temperature 72

# INDEX

---

Memory Hole At 15M-16M 61  
Message LED Lead 43  
Microsoft DirectX 96  
Modem Riser 119  
Monitor Output Connector 33  
Motherboard  
    Layout 14  
    Part Locations 13  
    Settings 17  
Multi-Sector Transfers 55

## O

ONB VGA BIOS First 65  
Onboard AC97 Modem Controller 62  
Onboard Audio Controller 62  
Onboard Audio Setting 19  
Onboard CIR I/O 63  
Onboard CIR IRQ 63  
Onboard FDC Swap A & B 62  
Onboard Game Port 63  
Onboard ISA Bridge 61  
Onboard LAN Power Setting 20  
Onboard LAN Setting 20  
Onboard MIDI I/O 63  
Onboard MIDI IRQ 63  
Onboard PCI IDE Enable 61  
Onboard Serial Port 1 62  
Onboard Serial Port 2 62  
Onboard VGA 61  
Operating Systems 80  
OS/2 Onboard Memory > 64M 59  
Other Boot Device Select 73

## P

Parallel Port Connector 32  
Parallel Port Mode 63  
Password  
    Supervisor 56  
    User 56  
PC Probe  
    Setup 87  
    Using 105  
PC-cillin 98 Setup 97  
PCI 2.1 Support 61  
PCI Latency Timer 64

PCI/VGA Palette Snoop 64  
PIO Mode 55  
Plug & Play O/S 74  
Power Connection Procedures 45  
Power Fan Speed 72  
Power Management 68  
Power Supply Fan Connector 36  
Primary IDE Connector 34  
Procedure  
    Expansion Card 27  
    Hardware Setup 17  
Procedures  
    CPU Installation 26  
    Modem Riser Installation 119  
    Power Connection 45  
    Updating BIOS 47  
Programs  
    Uninstalling 98  
PS/2 Keyboard Connector 31  
PS/2 Mouse Connector 31  
PS/2 Mouse Function Control 59  
PWR Button < 4 Secs 69  
PWR Up On Modem Act 70

## Q

Quick Power On Self Test 74

## R

Removable Device 73  
Reset Switch Lead 43

## S

S370 Series CPU Cards 117  
Safe Mode Setting 21  
Save Changes 76  
SDRAM Address Setup Time 61  
SDRAM CAS Latency 60  
SDRAM Configuration 60  
SDRAM Cycle Time (Tras, Trc) 61  
SDRAM Page Closing Policy 61  
SDRAM RAS Precharge Time 60  
SDRAM RAS to CAS Delay 60  
Secondary IDE Connector 34  
Sector 55  
Serial IR Connector 38

# INDEX

---

Serial Port Connector 32  
Serial Port Header 38  
Settings  
    Automatic Timeout Reboot 21  
    CPU Frequency 22  
    I/O Voltage 19  
    JumperFree™ Mode 18  
    Onboard Audio 19  
    Onboard LAN 20  
    Onboard LAN Power 20  
    Safe Mode 21  
Slot 1/5 IRQ 64  
Slot 2 IRQ 64  
Slot 3/6 IRQ 64  
Slot 4 IRQ 64  
SMART Monitoring 55  
SMBus Connector 39  
Software Setup  
    Adobe Acrobat Reader 99  
    LDCM Administrator 84  
    LDCM Client 82  
    LiveUpdate 88  
    PC Probe 87  
    PC-cillin 98 97  
    Yamaha S-YXG50 92  
    Yamaha XGStudio 94  
Specifications 8  
Supervisor Password 56  
Support CD  
    Main Menu 77  
    Navigation Button 77  
    Submenus 78  
Suspend Mode 69  
Suspend-to-RAM Capability 69  
SYMBIOS SCSI BIOS 64  
System Date 52  
System Management Interrupt Lead 43  
System Memory 24  
System Power LED Lead 43  
System Time 52  
System Warning Speaker Connector 43

## T

Translation Method 54  
Type 53

## U

UART2 Use Standard Infrared 63  
Ultra DMA Mode 55  
Uninstalling Programs 98  
Universal Serial Bus 32  
Updating BIOS 46  
Updating BIOS Procedures 47  
USB Function 65  
USB Legacy Support 59  
User Password 56  
Using  
    LiveUpdate 110  
    PC Probe 105  
    Yamaha XGstudio Mixer 112  
    Yamaha XGstudio Player 111  
Utilities  
    AFLASH 46

## V

VCORE Voltage 72  
Video Off Method 69  
Video Off Option 69  
Video ROM BIOS Shadow 67  
Voltages  
    +12V 72  
    +3.3V 72  
    +5V 72  
    -12V 72  
    -5V 72  
VCORE 72

## W

Wake On LAN 70  
Wake On PS2 KB/Mouse 71  
Wake-On-LAN Connector 35  
Wake-On-Ring Connector 35

## Y

Yamaha S-YXG50 92  
Yamaha XGStudio 94  
Yamaha XGstudio Mixer 112  
Yamaha XGstudio Player 111

# ASUS<sup>®</sup>

# Goes Mobile!

## M8300/8200 Series

*Thin & Light Convertible Notebook PC*

13.3" or 12.1" TFT Color Display

233/266/300/333/366/400+MHz



## F7400 Series

*Professional Notebook PC*

14.1" TFT Color Display

300/333/366/400+MHz

Built-in DVD/MPEG2 Decoder

## L7300/7200 Series

*All-in-One Compact Notebook PC*

13.3" or 12.1" TFT Color Display

300/333/366/400+MHz



# ASUS® Ultra-Fast CD-ROM



- Supports high speed CD-Audio playback
- Supports high speed digital audio extraction
- Supports UltraDMA/33 transfer mode
- Compatible with all CD formats
- Supports multi-read function (CD-R/CD-RW)



Drive Interface Type:	ATAPI/Enhanced IDE supporting PIO mode 4, multi-word DMA mode 2, UltraDMA/33
Disc Formats:	Audio CD, CD-ROM (mode 1 & mode 2), Mixed mode, CD-ROM/XA (mode 2, form 1 & form 2), Video CD, CD-I, Photo CD (single & multi-session), Karaoke CD, CD Extra, I-Trax, CD-R, CD-RW
Disk Size:	8 cm and 12 cm
OS Compatibility:	DOS 6.xx, Windows 3.x/95/98, OS/2 Warp, Netware, SCO UNIX
Cache Buffer Size:	128KB
Data Transfer Rate:	CD-S500 7500 KBps maximum CD-S450 6750 KBps maximum CD-S400 6000 KBps maximum
Access Time:	75ms

# ASUS® Barebone Servers

	Pentium® III Pentium® II Support	PC100 ECC Max. Memory (GB)	Ultra2 SCSI Onboard (Channels)	5.25" Fixed Storage Devices	Hot-Swap Trays
<b>AP100</b>	1	1	1	3	0
<b>AP200</b>	2	1	1	3	0
<b>AP2000</b>	2	1	1	4	3 or 5*
<b>AP2500</b>	2	1	1	4	3 or 5*
<b>AP3000</b>	2 Xeon™	2	2	4	3 or 5*
<b>AP6000</b>	2	1	1	4	8**
<b>AP7500</b>	2	1	1	4	8**
<b>AP8000</b>	2 Xeon™	2	2	4	8**

\* Three 1.6-inch or five 1-inch SCA-2 SCSI hard drives

\*\* Eight 1.6-inch or 1-inch SCSI hard drives

## Mid-Range Servers

AP6000  
AP7500  
AP8000

## Value Servers

AP2000  
AP2500  
AP3000

## Group Servers

AP100  
AP200



Rack Mountable



## ASUS AR1000 RAID Sub-system with DA3000 SCSI-to-SCSI RAID Controller

- Supports 5x86 RAID processor and two 72-pin SIMM sockets for up to 128MB cache memory
- Supports three Ultra2 SCSI channels; up to 80MB/sec data transfer rate
- Supports multiple Host/Drive channel capacity
- Redundant controller capacity
- Supports non-RAID, RAID levels 0, 1, 0+1, 3, 5
- On-line failure drive rebuilding
- Automatic rebuilding — supports local/global spare drive
- On-line expansion capacity
- Supports SAF-TE (SCSI Accessed Fault-Tolerant Enclosure) feature
- Provides LCD panel and RS-232 port to configure RAID
- Ten 1.0" or six 1.6" Ultra2 SCSI SCA-2 hot-swappable drive bays
- 19" rack mountable (height: 5U)
- LED for hard disk power and working status
- Two 8cm system fans and four 6cm drive fans
- Aluminum disk arrays for easy heat dissipation
- 350W redundant power supply

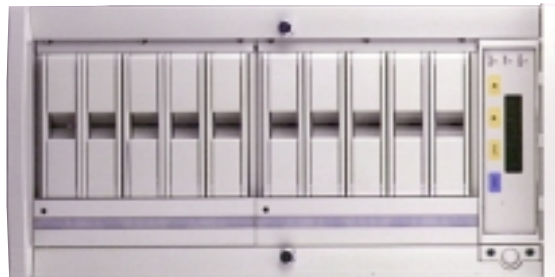

## ASUS PCI-DA2100/2200 Series SCSI RAID Card

- PCI-DA2100 series support 4x86 DX4-100 processor
- PCI-DA2200 series support 5x86-133 processor
- One 72-pin SIMM socket supports up to 128MB cache memory
- RAID levels 0, 0+1, 3, 5, non-RAID
- PCI-DA2100A supports Ultra Wide SCSI interface and dual channels
- PCI-DA2200A supports Ultra2 SCSI interface and single channel
- PCI-DA2200B supports Ultra2 SCSI interface and dual channels
- Automatic bad sector reassignment
- Supports both global and local spare drive operation
- Background rebuilding
- PCI rev. 2.1 compliant
- Up to 8 logical drives and 8 partitions per logical drive; number of drives for each logical drive has no limitation

