

---

## **Federal Communications Commission (F.C.C) Statement**

This device complies with Part 15 of the FCC Rules. Operation of this device is subject to the following two conditions: (1) this device may not cause harmful interference, and (2) this device must accept any interference received, including interference that may cause undesired operation.

Accessories: This device has been tested and found to comply with the limits of a Class B digital device, the accessories associated with this equipment are as follows:

1. Shielded serial cable. (Can be obtained from multiple retail outlets)
2. Shielded printer cable. (Can be obtained from multiple retail outlets)
3. Shielded video cable. (Can be obtained from multiple retail outlets)
4. Shielded power cord. (Provided by manufacturer)

These accessories are required to ensure compliance with FCC Rules. It is the responsibility of the user to provide and use these accessories properly.

This equipment has been tested and found to comply with the limits of a Class B digital device, pursuant to Part 15 of the FCC Rules. These limits are designed to provide reasonable protection against harmful interference in a residential installation. This equipment generates, uses and can radiate radio frequency energy and, if not installed and used in accordance with the instructions, may cause harmful interference to radio communications. There is no guarantee that interference will not occur in a particular installation. If this equipment does cause harmful interference to radio or television reception, which can be determined by turning the equipment off and on, you are encouraged to try to correct the interference by one or more of the following measures:

1. Reorient / relocate the receiving antenna.
  2. Increase the separation between the equipment and receiver.
  3. Connect the equipment into an outlet on a circuit different from that to which the receiver is connected.
  4. Consult the dealer or an experienced radio/TV technician for help.
-

---

Caution: Changes or modifications not expressly approved by the manufacturer could void the user's authority to operate the equipment.

## **Disclaimer**

The vendor makes no representations or warranties with respect to the contents here of and specially disclaims any implied warranties of merchantability or fitness for any purpose. Further the vendor reserves the right to revise this publication and to make changes to the contents here of without obligation to notify any party beforehand.

Duplication of this publication, in part or in whole, is not allowed without first obtaining the vendor's approval in writing.

## **Trademarks and Remarks**

MS-DOS, Windows, Windows NT, and Windows 9X are products of Microsoft Corp, with its ownership of trademark, and are distributed by the vendor under a license agreement.

All trademarks used in this manual are the property of their respective owners.

Copyright© 1999  
All Rights Reserved

## **Canadian D.O.C. Statement**

This digital apparatus does not exceed the Class B limits for radio noise emissions from digital apparatus as set out in the radio interference regulations of the Canadian Department of Communications.

Cet appareil numérique n'émet pas de bruits radioélectriques dépassant les limites appliquées aux appareils numériques de Class B prescrits dans le règlement du brouillage radioélectrique édicté par le ministre Des Communications du Canada.

---

## **Contents**

---

<b>Introduction .....</b>	<b>1-1</b>
<b>1 Motherboard Description .....</b>	<b>1-2</b>
1.1 Features .....	1-2
1.1.1 Hardware .....	1-2
1.1.2 Software .....	1-4
1.1.3 Attachments .....	1-4
1.2 Motherboard Installation .....	1-5
1.2.1 Layout of Motherboard .....	1-5
1.3 Motherboard Connectors .....	1-6
1.3.1 Front Panel Connectors (PANEL1) .....	1-7
1.3.2 Floppy Disk Connector (FDD1) .....	1-9
1.3.3 Hard Disk Connectors (IDE1/IDE2) .....	1-9
1.3.4 ATX 20-pin Power Connector (CN1) .....	1-10
1.4 Back Panel Connectors .....	1-11
1.4.1 PS/2 Mouse / Keyboard CONN. : PS2_KBMS .....	1-11
1.4.2 USB Connectors : USB .....	1-12
1.5 Serial and Parallel Interface Ports .....	1-14
1.6 CPU Installation .....	1-17
1.6.1 CPU Installation Procedure .....	1-17
1.6.2 CPU Clock Selection : SW1 .....	1-21
1.7 Jumper Settings .....	1-22
1.7.1 CPU Fan Connector: FAN1 .....	1-22

## **Contents**

---

1.7.2 System Fan Connector: FAN2.....	1-23
1.7.3 Wake-On MODEM Header: WOM (Optional).....	1-23
1.7.4 Wake-On-LAN Header: WOL .....	1-23
1.7.5 AMR Code Primary/Secondary Selection: J1 .....	1-23
1.7.6 CMOS Function Selection: JBAT .....	1-24
1.8 DRAM Installation.....	1-25
1.8.1 DIMM .....	1-25
1.8.2 How to install a DIMM Module.....	1-27
1.9 Audio Subsystem.....	1-28
1.9.1 CD Audio-In Connectors : CD_IN / J4 .....	1-29
1.9.2 Telephony Connector : J5.....	1-29
<b>2. BIOS Setup.....</b>	<b>2-1</b>
2.1 Main Menu.....	2-3
2.2 Standard CMOS Features.....	2-5
2.3 Advanced BIOS Features .....	2-8
2.4 Advanced Chipset Features.....	2-13
2.5 Integrated Peripherals .....	2-16
2.6 Power Management Setup.....	2-20
2.7 PnP/PCI Configurations .....	2-24
2.8 PC Health Status .....	2-27
2.9 Load Fail-Safe Defaults .....	2-29
2.10 Load Optimized Defaults .....	2-30
2.11 Set Supervisor / User Password .....	2-31

## **Contents**

---

2.12 Save & Exit Setup .....	2-33
2.13 Exit Without Saving .....	2-34
<b>3. Software Setup .....</b>	<b>3-1</b>
3.1 Software List .....	3-1
3.2 Software Installation .....	3-2
3.3 Using Software .....	3-3
<b>4. Trouble shooting.....</b>	<b>4-1</b>

## Introduction

### System Overview

Thanks for buying this product! This manual was written to help you start using this product as quickly and smoothly as possible. Inside you will find adequate explanations to solve most problems. In order for this reference material to be of greatest use, refer to the “expanded table of contents” to find relevant topics.

This board incorporates the system board, I/O, and PCI IDE into one board that provides a total PC solution. The mainboard, a AMD-Athlon™ processor based PC/ Micro ATX system, supports single processors with PCI Local Bus, and AGP Bus to support upgrades to your system performance. It is ideal for multi-tasking and fully supports MS-DOS, Windows, Windows NT, Windows 2000, Novell, OS/2, Windows95/98, UNIX, SCO UNIX etc. This manual also explains how to install the mainboard for operation, and how to setup your CMOS configuration with the BIOS setup program.

# 1 Motherboard Description

## 1.1 Features

### 1.1.1 Hardware

#### CPU

- Single Slot-A for AMD-Athlon™ processor Module-500MHz and faster.
- 200MHz system interface speed.

#### Speed

- Support 33MHz PCI Bus speed.
- Support 4X AGP Bus.

#### DRAM Memory

- Supports 8/16/32/64.....MB DIMM module socket.
- Supports Synchronous DRAM (3.3V).
- Support a maximum memory size of 768MB with SDRAM.

#### Shadow RAM

- A memory controller provide shadow RAM and supports 8-bit ROM BIOS.

#### Green Function

- Support power management operation via BIOS.
- Power down timer from 1 to 15 mins.
- Wakes from power saving sleep mode at the press of any key or any mouse activity.

#### BUS Slots

- Provide one AGP slot and one AMR slot.
- Two 32-bit PCI bus master slots.

**Flash Memory**

- Support flash memory.
- Support ESCD function.

**PCI Enhanced IDE Built-in On Board**

- Supports four IDE hard disk drives.
- Supports PIO Mode 4, Master Mode, high performance hard disk drives.
- Support Ultra DMA 33 / 66, Bus Master Mode.
- Supports IDE interface with CD-ROM.
- Supports high capacity hard disk drives.
- Support LBA mode.

**PCI-Based AC 97 Digital Audio Processor (Optional)**

- AC 97 2.1 interface.
- 16 channels of high-quality sample rate conversion.
- 16x8 channel digital mixer.
- Stereo 10 band graphic equalizer.
- Sound Blaster® and Sound Blaster Pro® emulation.
- S/PDIF output (allows standard interface to consumer electronics).
- 64-voice wavetable.
- PC99 complaint and WHQL certified.

**I/O Built-in On Board**

- Supports one multi-mode Parallel Port.
  - (1) Standard & Bidirection Parallel Port.
  - (2) Enhanced Parallel Port (EPP).
  - (3) Extended Capabilities Port (ECP).
- Supports two serial ports, 16550 UART.
- Supports one Infrared transmission (IR).
- Supports PS/2 mouse and PS/2 keyboard.
- Supports 360KB, 720KB, 1.2MB, 1.44MB, and 2.88MB floppy disk drivers.



**Universal Serial Bus**

- Supports two back Universal Serial Bus (U.S.B.) ports and two front Universal serial Bus (U.S.B) ports.
- Supports 48 MHz USB.

**Hardware Monitor Function**

- CPU Fan Speed Monitor.
- System and CPU Temperature Monitor.
- System Voltage Monitor.

**Dimensions (Micro ATX form-factor)**

- 24.5 cm X 21.3 cm (W x L)

**1.1.2 Software****BIOS**

- AWARD legal BIOS.
- Supports APM1.2.
- Supports USB function.
- Supports ACPI.

**Operating System**

- Offers the highest performance for MS-DOS, OS/2, Windows, Windows NT, Windows 2000, Windows 95/98, Novell, UNIX, SCO UNIX etc.

**1.1.3 Attachments**

- HDD cable.
- FDD cable.
- Flash memory writer for BIOS update.
- Retention kits for CPU.
- Sound and Hardware Monitor setup driver CD.
- USB2 cable (Optional).
- Rear I/O Panel for ATX case (Optional).

## 1.2 Motherboard Installation

### 1.2.1 Layout of Motherboard

Model No.M7MKB

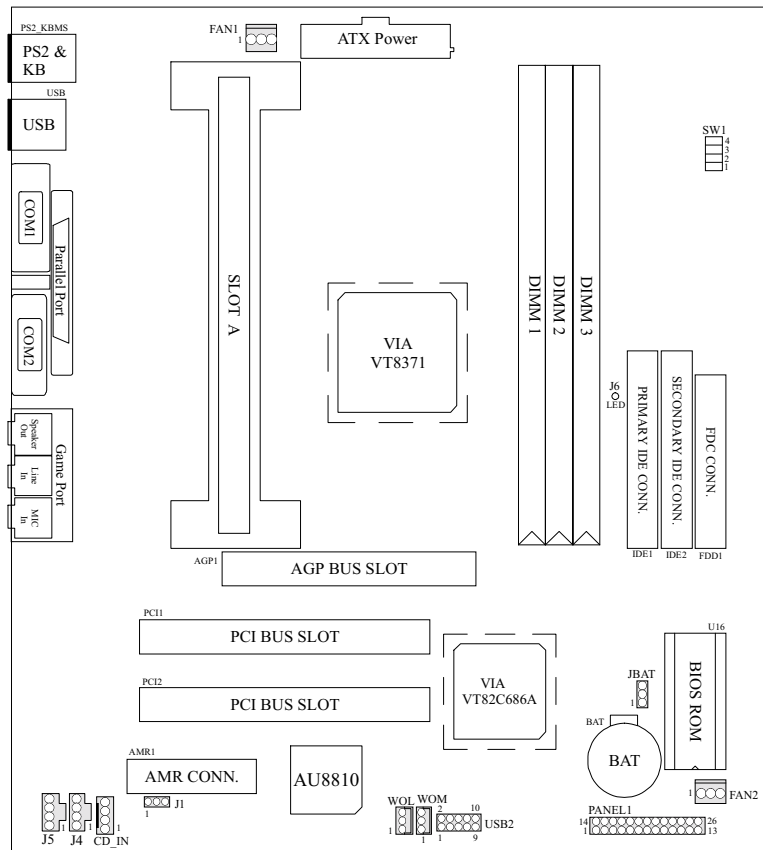

## 1.3 Motherboard Connectors

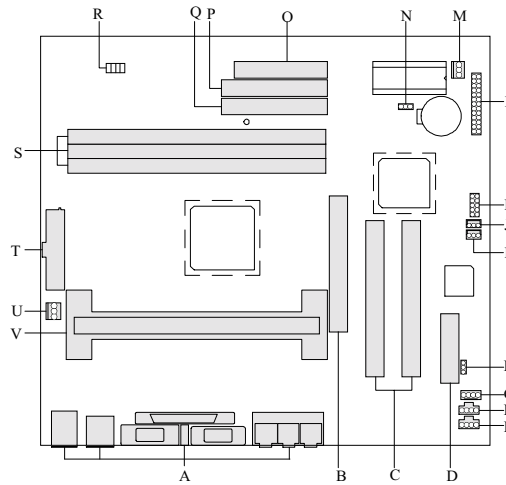

- |  |   |
|--|---|
| <b>A. Back Panel I/O Connectors</b>                    | <b>K. Front Two USB Connector (USB2) (Optional)</b> |
| <b>B. AGP Bus Slot (AGP1)</b>                          | <b>L. Front Panel Connector (PANEL1)</b>            |
| <b>C. PCI Bus Slots (PCI1-2)</b>                       | <b>M. System Fan Connector (FAN2)</b>               |
| <b>D. AMR Bus Slot (AMR1)</b>                          | <b>N. CMOS Function Selection (JBAT)</b>            |
| <b>E. Telephony Connector (J5)</b>                     | <b>O. FDD Connector (FDD1)</b>                      |
| <b>F. CD Audio-In Connector (J4)</b>                   | <b>P. Secondary IDE Connector (IDE2)</b>            |
| <b>G. CD Audio-In Connector (CD_IN)</b>                | <b>Q. Primary IDE Connector (IDE1)</b>              |
| <b>H. AMR CODEC Primary / Secondary Selection (J1)</b> | <b>R. CPU Clock Selection (SW1)</b>                 |
| <b>I. Wake-On-LAN Connector (WOL)</b>                  | <b>S. DIMMs (DIMM1-3)</b>                           |
| <b>J. Wake-On MODEM Connector (WOM) (Optional)</b>     | <b>T. ATX Power Connector (CN1)</b>                 |
|  | <b>U. CPU FAN Connector (FAN1)</b>                  |
|  | <b>V. Slot A (CPU1)</b>                             |

### 1.3.1 Front Panel Connectors (PANEL1)

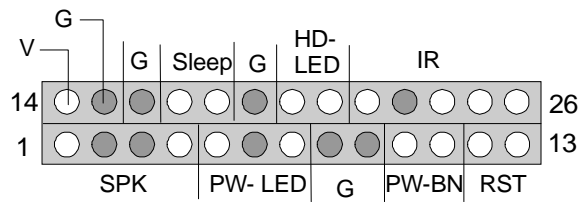

Pin No.	Assignment	Function	Pin No.	Assignment	Function
1	Speaker	SPK (Speaker Connector)	14	+5V	V (VCC)
2	No Connection		15	Ground	G (Ground)
3	No Connection		16	Ground	G (Ground)
4	+5V		17	Green Control	Sleep (Green Switch)
5	Power LED(+)	18	Ground		
6	No Connection	PW-LED (Power LED)	19	Ground	G(Ground)
7	Ground		20	HDD LED(-)	HD-LED (HDD LED)
8	Ground	G (Ground)	21	HDD LED(+)	
9	Ground		22	+5V	IR (IrDA Connector)
10	Power Switch	PW-BN (ATX Power Button)	23	No Connection	
11	Standby Voltage		24	IRRX	
12	Reset Control	RST (Reset Button)	25	Ground	
13	Ground		26	IRTX	

**SPK (Speaker Connector)**

An offboard speaker can be installed on the motherboard as a manufacturing option. An offboard speaker can be connected to the motherboard at the front panel connector. The speaker (onboard or offboard) provides error beep code information during the Power On Self-Test when the computer cannot use the video interface. The speaker is not connected to the audio subsystem and does not receive output from the audio subsystem.

**RST (Reset Button)**

This connector can be connected to a momentary SPST type switch that is normally open. When the switch is closed, the motherboard resets and runs the POST.

**PW-LED (Power LED Connector)**

This connector can be connected to an LED that will light when the computer is powered on.

**HD-LED (Hard Drive LED Connector)**

This connector can be connected to an LED to provide a visual indicator that data is being read from or written to a hard drive. For the LED to function properly, an IDE drive must be connected to the onboard hard drive controller.

**IR (Infrared Connector)**

After the IrDA interface is configured, files can be transferred from or to portable devices such as laptops, PDAs, and printers using application software.

**Sleep (Green Button)**

When APM is enabled in the system BIOS, and the operating system's APM driver is loaded, the system can enter sleep (standby) mode in one of the following ways.

**PW-BN (ATX Power Connector)**

This connector can be connected to a front panel power switch. The switch must pull the Power Button pin to ground for at least 50 ms to signal the power supply to switch on or off. (The time requirement is due to internal debounce circuitry on the motherboard). At least two seconds must pass before the power supply will recognize another on/off signal.

### **1.3.2 Floppy Disk Connector (FDD1)**

The motherboard provides a standard floppy disk connector (FDC) that supports 360K, 720K, 1.2M, 1.44M and 2.88M floppy disk types. This connector supports the provided floppy drive ribbon cables.

### **1.3.3 Hard Disk Connectors (IDE1/IDE2)**

The motherboard has a 32-bit Enhanced PCI IDE Controller that provides PIO Mode 0~4, Bus Master, and Ultra DMA / 33, Ultra DMA / 66 functionality. It has two HDD connectors IDE1 (primary) and IDE2 (secondary). You can connect up to four hard disk drives, a CD-ROM, a 120MB Floppy (reserved for future BIOS) and other devices to IDE1 and IDE2. These connectors support the IDE hard disk cable provided.

#### **IDE1 (Primary IDE Connector)**

The first hard drive should always be connected to IDE1. IDE1 can connect a Master and a Slave drive. You must configure the second hard drive on IDE1 to Slave mode by setting the jumper accordingly.

#### **IDE2 (Secondary IDE Connector)**

The IDE2 controller can also support a Master and a Slave drive. The configuration is similar to IDE1. The second drive on this controller must be set to slave mode.

### 1.3.4 ATX 20-pin Power Connector (CN1)

This connector supports the power button on-board. Using the ATX power supply, functions such as Modem Ring Wake-Up and Soft Power Off are supported on this motherboard. This power connector supports instant power-on functionality, which means that the system will boot up instantly when the power connector is inserted on the board.

PIN	SIGNAL	PIN	SIGNAL
1	3.3V	11	3.3V
2	3.3V	12	-12V
3	GND	13	GND
4	5V	14	PS_ON
5	GND	15	GND
6	5V	16	GND
7	GND	17	GND
8	PW_OK	18	-5V
9	5V_SB	19	5V
10	12V	20	5V

## 1.4 Back Panel Connectors

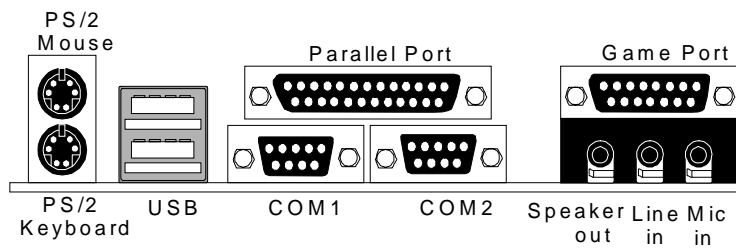

### 1.4.1 PS/2 Mouse / Keyboard CONN. : PS2\_KBMS

The motherboard provides a standard PS/2 mouse / keyboard mini DIN connector for attaching a PS/2 mouse. You can plug a PS/2 mouse / keyboard directly into this connector. The connector location and pin definition are shown below:

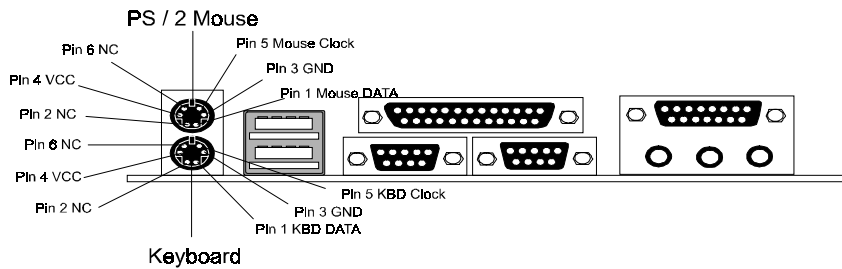



**PS/2 Mouse / Keyboard Connectors**

Pin	Signal Name
1	Data
2	No connect
3	Ground
4	+5 V (fused)
5	Clock
6	No connect

**1.4.2 USB Connectors : USB**

The motherboard provides a **OHCI (Open Host Controller Interface) Universal Serial Bus Roots** for attaching USB devices such as: keyboard, mouse and other USB devices. You can plug the USB devices directly into this connector.

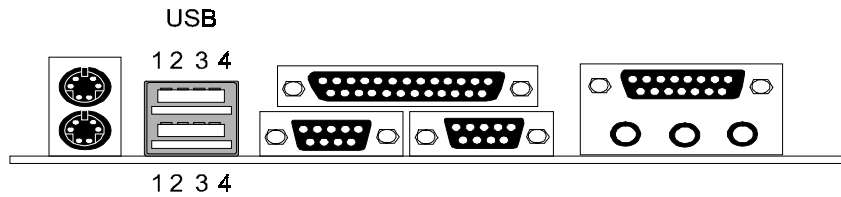
**Stacked USB Connectors**

Pin	Signal Name
1	+5 V (fused)
2	USBP0- [USBP1-]
3	USBP0+ [USBP1+]
4	Ground

Signal names in brackets ([ ]) are for USB port 1.

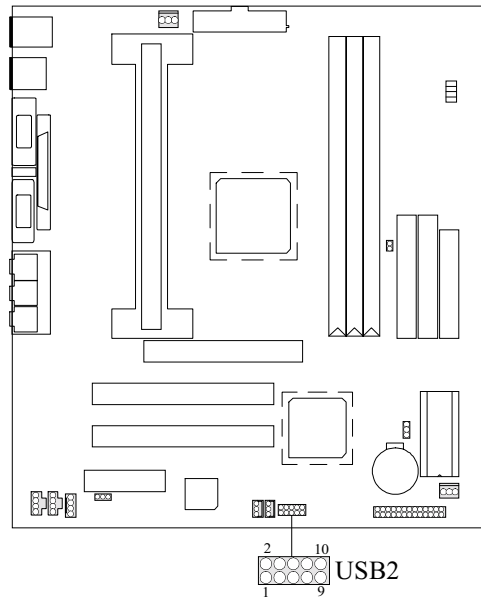
**Front Two USB Connector: USB2 (Optional)**

Pin	Signal Name	Pin	Signal Name
1	+5V	2	Ground
3	USBP2-	4	Ground
5	USBP2+	6	USBP3+
7	Ground	8	USBP3-
9	Ground	10	+5V

## 1.5 Serial and Parallel Interface Ports

This system comes equipped with two serial ports and one parallel port. Both types of interface ports will be explained in this chapter.

### The Serial Interface: COM1/COM2

The serial interface port is sometimes referred to as an RS-232 port or an asynchronous communication port. Mice, printers, modems and other peripheral devices can be connected to a serial port. The serial port can also be used to connect your computer with another computer system. If you wish to transfer the contents of your hard disk to another system it can be accomplished by using each machine's serial port.

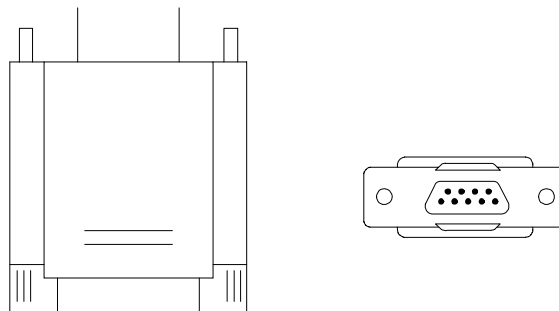

The serial ports on this system have two 9-pin connectors. Some older computer systems and peripherals used to be equipped with only one 25-pin connector. Should you need to connect your 9-pin serial port to an older 25-pin serial port, you can purchase a 9-to-25 pin adapter.

**Connectivity**

The serial ports can be used in many ways, and it may be necessary to become familiar with the pinout diagram. The following chart gives you the function of each pin on the 9-pin connector and some of the 25-pin connector. This information can be used when configuring certain software programs to work with the serial ports.

<b>Signal</b>	<b>Name</b>	<b>DB9 PIN</b>	<b>DB25 PIN</b>
DCD	Data Carrier Detect	1	8
RX	Receive Data	2	3
TX	Transmit Data	3	2
DTR	Data Terminal Ready	4	20
GND	Signal Ground	5	7
DSR	Data Set Ready	6	6
RTS	Request to Send	7	4
CTS	Clear to Send	8	5
RI	Ring Indicator	9	22

### Parallel Interface Ports

Unlike the serial ports, parallel interface port has been standardized and should not present any difficulty interfacing peripherals to your system. Sometimes called Centronics port, the parallel port is almost exclusively used with printers. The parallel port on your system has a 25-pin, DB5 connector (see picture below). The pinouts for the parallel port are shown in the table below.

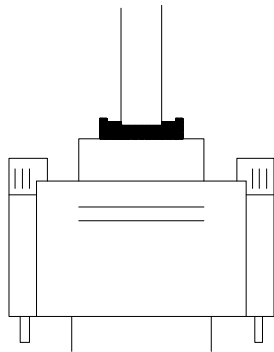
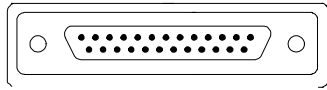

Signal	Pin
-Strobe	1
Data 0	2
Data 1	3
Data 2	4
Data 3	5
Data 4	6
Data 5	7
Data 6	8
Data 7	9
-Ack	10
Busy	11
Paper Empty	12
+Select	13
-Auto FDXT	14
-Error	15
-Init	16
-SLCTN	17
Ground	18
Ground	19
Ground	20
Ground	21
Ground	22
Ground	23
Ground	24
Ground	25

## 1.6 CPU Installation

### 1.6.1 CPU Installation Procedure

#### Motherboard

The motherboard provides one Single Slot-A.  
This slot allows you to install an AMD-Athlon™ CPU.

#### Before you use:

Please look on your motherboard and locate the CPU fan and CPU fan power supply. Please verify that this fan is directly used to cool the CPU, its heat sink, the motherboard and circulate the air.

**WARNING : If air circulation is insufficient, the CPU will overheat, which may damage the CPU, CPU slot, and the motherboard.**

Please inspect your motherboard to see if it has the AMD-Athlon™ CPU retention kit components. (ATTENTION: The CPU installation component color and shape may vary slightly based on kits coming from different suppliers.)

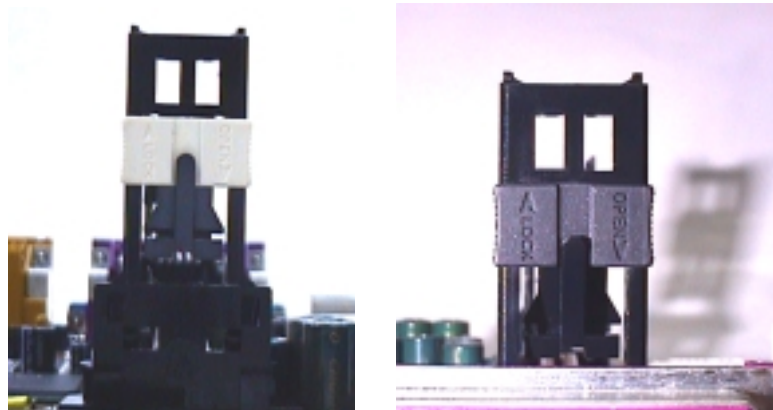

**M7MKB CPU Special Installation and Setup :****AMD-Athlon™ CPU:****1 · Installing the Heat Sink Support Frame :**

The Heat Sink Support Base can only be inserted in one-way. Please match the leg sizes on the Heat Sink Support Base to the holes on the motherboard. Please insert the screws from the bottom of the motherboard and tighten into the rounded screw covers.

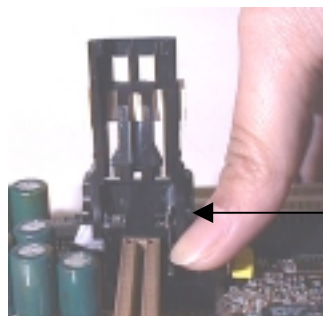

Lock in

**2 · Insert the CPU into the SEC Solt :**

- (1) First, press the CPU unit into the frame until it fits snugly into the notch holes. Then, clip the heat sink and CPU together with the Heat Sink Support Frame.

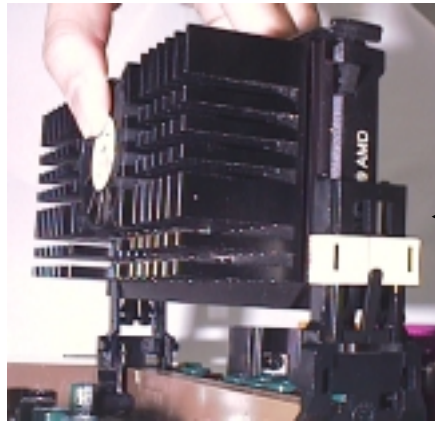

The correct direction to insert the heat sink and CPU into the Heat Sink Support Frame should allow you to easily insert them.

- (2) Pushing the CPU unit into the frame, and waiting until the CPU unit is firmly in position before securing. The notches are pushed out. They will fit tightly into the Heat Sink Frame notch holes.

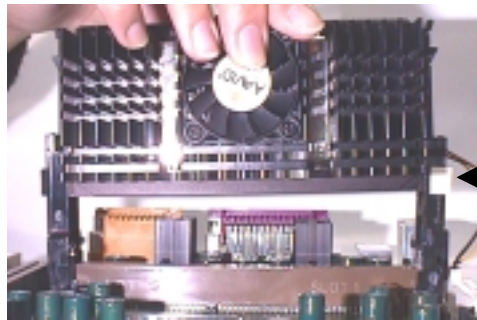

The notches on the CPU unit are pushed out to fit into the notch holes.



- (3) Firmly secure the Heat Sink by attaching the Heat Sink Frame TOP-Bar. Please verify that the heat sink and CPU are tightly pressed together. Please check that the entire frame, heat sink, and CPU unit are tightly installed and that there is no possible movement or looseness in the assembly.



### 1.6.2 CPU Clock Selection : SW1

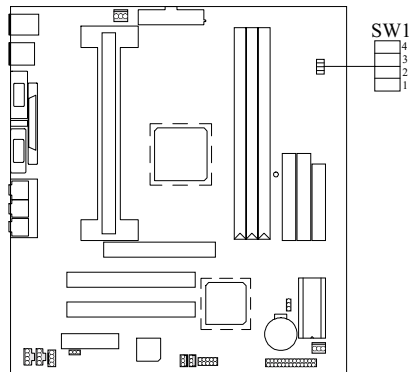

CPU clock	PCI	SW1 (1)	SW1 (2)	SW1 (3)	SW1 (4)
100 MHz	33.3 MHz	ON	OFF	OFF	OFF
102 MHz	34.0 MHz	ON	ON	ON	OFF
104 MHz	34.6 MHz	OFF	OFF	OFF	ON
106 MHz	35.3 MHz	ON	OFF	OFF	ON
107 MHz	35.6 MHz	OFF	ON	OFF	ON
108 MHz	36.0 MHz	ON	ON	OFF	ON
109 MHz	36.3 MHz	OFF	OFF	ON	ON
110 MHz	36.6 MHz	ON	OFF	ON	ON
111 MHz	37.0 MHz	OFF	ON	ON	ON
112 MHz	37.3 MHz	ON	ON	ON	ON
133.3 MHz	33.3 MHz	ON	OFF	ON	OFF

*NOTE: CPU clock speed over 100MHz is not recommended.*

## 1.7 Jumper Settings

A jumper has two or more pins which may be covered by a plastic jumper cap, allowing you to select different system options.

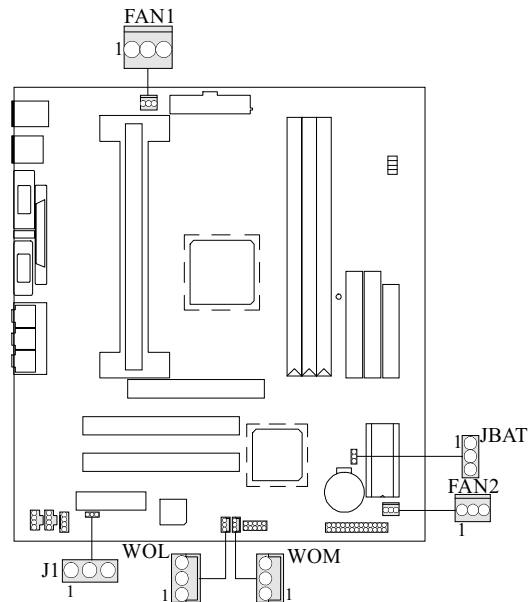

### 1.7.1 CPU Fan Connector: FAN1

Pin No.	Assignment
1	Control PIN
2	+12V
3	GND

**1.7.2 System Fan Connector: FAN2**

Pin No.	Assignment
1	Control PIN
2	+12V
3	GND

**1.7.3 Wake-On MODEM Header: WOM (Optional)**

Pin No.	Assignment
1	5V SB
2	GND
3	Wake Up

**1.7.4 Wake-On-LAN Header: WOL**

Pin No.	Assignment
1	5V SB
2	Ground
3	Wake up

**1.7.5 AMR Code Primary/Secondary Selection: J1**

Pin No.	Assignment
1-2	Secondary
2-3	Primary

### 1.7.6 CMOS Function Selection: JBAT

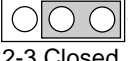
JBAT	Assignment
 1-2 Closed	Normal Operation (default)
 2-3 Closed	Clear CMOS Data

Note: Please follow the procedure as below to clear CMOS data.

Note: Please follow the procedure as below to clear BIOS password if your password is lost or forgotten.

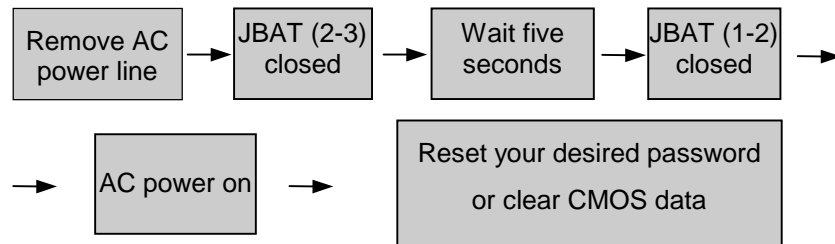

## 1.8 DRAM Installation

### 1.8.1 DIMM

DRAM Access Time: 3.3V Unbuffered SDRAM PC66/ PC100 and PC133 Type required.

DRAM Type: 8MB/ 16MB/ 32MB/ 64MB/ 128MB/ 256MB DIMM Module (168pin)

Total	Bank 0	Bank 1	Bank 2
Memory Size (MB)	DIMM1	DIMM2	DIMM3
8 M	8M x 1 pc	----	----
16 M	16M x 1 pc	----	----
32 M	32M x 1 pc	----	----
64 M	64M x 1 pc	----	----
128 M	128M x 1 pc	----	----
256 M	256M x 1 pc	----	----
16 M	8M x 1 pc	8M x 1 pc	----
32 M	16M x 1 pc	16M x 1 pc	----
64 M	32M x 1 pc	32M x 1 pc	----
128 M	64M x 1 pc	64M x 1 pc	----
256 M	128M x 1 pc	128M x 1 pc	----
512 M	256M x 1 pc	256M x 1 pc	----
24 M	8M x 1 pc	8M x 1 pc	8M x 1 pc
40 M	16M x 1 pc	16M x 1 pc	8M x 1 pc
72 M	32M x 1 pc	32M x 1 pc	8M x 1 pc
136 M	64M x 1 pc	64M x 1 pc	8M x 1 pc
264 M	128M x 1 pc	128M x 1 pc	8M x 1 pc
520 M	256M x 1 pc	256M x 1 pc	8M x 1 pc
32 M	8M x 1 pc	8M x 1 pc	16M x 1 pc
48 M	16M x 1 pc	16M x 1 pc	16M x 1 pc
80 M	32M x 1 pc	32M x 1 pc	16M x 1 pc
144 M	64M x 1 pc	64M x 1 pc	16M x 1 pc
272 M	128M x 1 pc	128M x 1 pc	16M x 1 pc
528 M	256M x 1 pc	256M x 1 pc	16M x 1 pc

Total	Bank 0	Bank 1	Bank 2
Memory Size (MB)	DIMM1	DIMM2	DIMM3
48 M	8M x 1 pc	8M x 1 pc	32M x 1 pc
64 M	16M x 1 pc	16M x 1 pc	32M x 1 pc
96 M	32M x 1 pc	32M x 1 pc	32M x 1 pc
160 M	64M x 1 pc	64M x 1 pc	32M x 1 pc
288 M	128M x 1 pc	128M x 1 pc	32M x 1 pc
544 M	256M x 1 pc	256M x 1 pc	32M x 1 pc
80 M	8M x 1 pc	8M x 1 pc	64M x 1 pc
96 M	16M x 1 pc	16M x 1 pc	64M x 1 pc
128 M	32M x 1 pc	32M x 1 pc	64M x 1 pc
192 M	64M x 1 pc	64M x 1 pc	64M x 1 pc
320 M	128M x 1 pc	128M x 1 pc	64M x 1 pc
576 M	256M x 1 pc	256M x 1 pc	64M x 1 pc
144 M	8M x 1 pc	8M x 1 pc	128M x 1 pc
160 M	16M x 1 pc	16M x 1 pc	128M x 1 pc
192 M	32M x 1 pc	32M x 1 pc	128M x 1 pc
256 M	64M x 1 pc	64M x 1 pc	128M x 1 pc
384 M	128M x 1 pc	128M x 1 pc	128M x 1 pc
640 M	256M x 1 pc	256M x 1 pc	128M x 1 pc
272 M	8M x 1 pc	8M x 1 pc	256M x 1 pc
288 M	16M x 1 pc	16M x 1 pc	256M x 1 pc
320 M	32M x 1 pc	32M x 1 pc	256M x 1 pc
384 M	64M x 1 pc	64M x 1 pc	256M x 1 pc
512 M	128M x 1 pc	128M x 1 pc	256M x 1 pc
768 M	256M x 1 pc	256M x 1 pc	256M x 1 pc

\*The list shown above for DRAM configuration is only for reference.

**Note: Don't stuff or remove the DIMM memory, If the J6 LED is lighting.**

## 1.8.2 How to install a DIMM Module

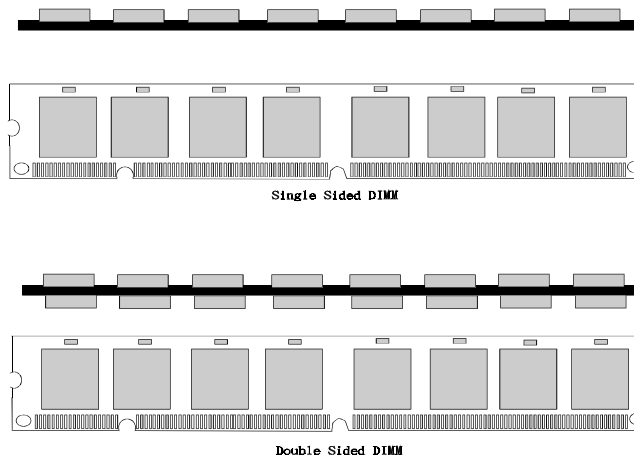

1. The DIMM socket has a “ Plastic Safety Tab” and the DIMM memory module has an asymmetrical notch”, so the DIMM memory module can only fit into the slot in one direction.

2. Push the tabs out. Insert the DIMM memory modules into the socket at a 90-degree angle then push down vertically so that it will fit into place.

3. The Mounting Holes and plastic tabs should fit over the edge and hold the DIMM memory modules in place.

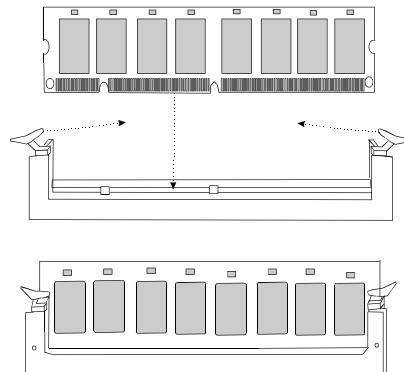



## 1.9 Audio Subsystem

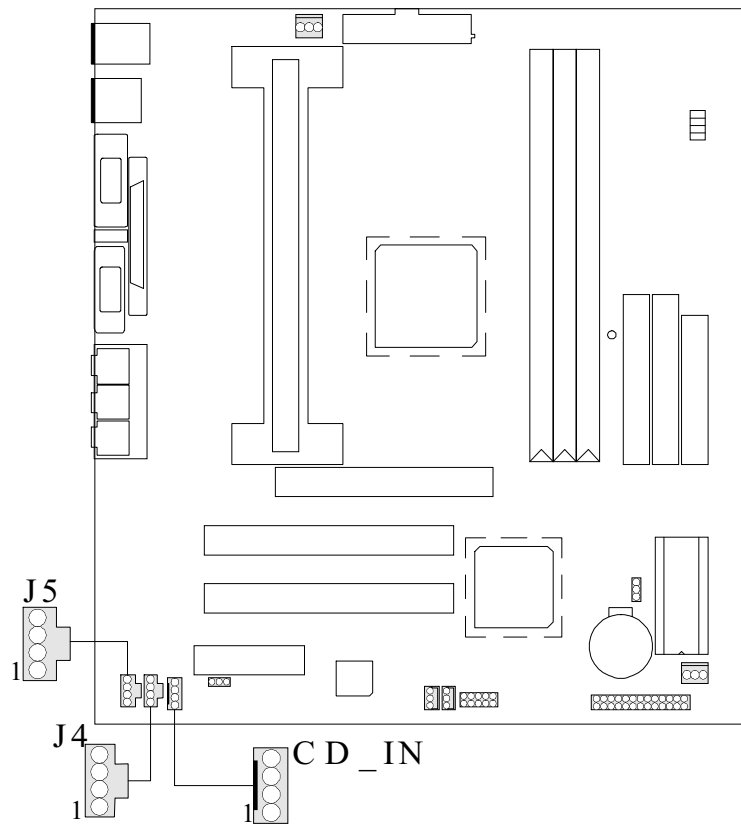

**1.9.1 CD Audio-In Connectors : CD\_IN / J4**

<b>Pin No. of CD_IN</b>	<b>Assignment</b>
1	Right Channel Input
2	GND
3	Left Channel Input
4	GND

<b>Pin No. of J4</b>	<b>Assignment</b>
1	Right Channel Input
2	GND
3	GND
4	Left Channel Input

**1.9.2 Telephony Connector : J5**

<b>Pin No.</b>	<b>TAD</b>
1	MONO_IN
2	GND
3	GND
4	MONO_OUT

## 2. BIOS Setup

### Introduction

This manual discusses Award™ Setup program built into the ROM BIOS. The Setup program allows users to modify the basic system configuration. This special information is then stored in battery-backed RAM so that it retains the Setup information when the power is turned off.

The Award BIOS™ installed in your computer system's ROM (Read Only Memory) is a custom version of an industry standard BIOS. This means that it supports AMD-Athlon™ processors input/output system. The BIOS provides critical low-level support for standard devices such as disk drives and serial and parallel ports.

Adding important has customized the Award BIOS™, but nonstandard, features such as virus and password protection as well as special support for detailed fine-tuning of the chipset controlling the entire system.

The rest of this manual is intended to guide you through the process of configuring your system using Setup.

### Plug and Play Support

These AWARD BIOS support the Plug and Play Version 1.0A specification. ESCD (Extended System Configuration Data) write is supported.

### EPA Green PC Support

This AWARD BIOS supports Version 1.03 of the EPA Green PC specification.

### APM Support

These AWARD BIOS supports Versions 1.1&1.2 of the Advanced Power Management (APM) specification. Power management features are implemented via the System Management Interrupt (SMI). Sleep and Suspend power management modes are supported. Power to the hard disk drives and video monitors can be managed by this AWARD BIOS.

### PCI Bus Support

This AWARD BIOS also supports Version 2.1 of the Intel PCI (Peripheral Component Interconnect) local bus specification.

### DRAM Support

SDRAM (Synchronous DRAM) are supported.

### Supported CPUs

This AWARD BIOS supports a single AMD-Athlon™ CPU.

### Using Setup

In general, you use the arrow keys to highlight items, press <Enter> to select, use the <PgUp> and <PgDn> keys to change entries, press <F1> for help and press <Esc> to quit. The following table provides more detail about how to navigate in the Setup program by using the keyboard.

Keystroke	Function
Up arrow	Move to previous item
Down arrow	Move to next item
Left arrow	Move to the item on the left (menu bar)
Right arrow	Move to the item on the right (menu bar)
Esc	Main Menu: Quit without saving changes Submenus: Exit Current page to the next higher level menu
Move Enter	Move to the item you desired
PgUp key	Increase the numeric value or make changes
PgDn key	Decrease the numeric value or make changes
+ Key	Increase the numeric value or make changes
- Key	Decrease the numeric value or make changes
Esc key	Main Menu – Quit and not save changes into CMOS Status Page Setup Menu and Option Page Setup Menu – Exit Current page and return to Main Menu
F1 key	General help on Setup navigation keys
F5 key	Load previous values from CMOS
F6 key	Load the fail-safe defaults from BIOS default table
F7 key	Load the optimized defaults
F10 key	Save all the CMOS changes and exit

## 2.1 Main Menu

Once you enter Award BIOS™ CMOS Setup Utility, the Main Menu will appear on the screen. The Main Menu allows you to select from several setup functions and two exit choices. Use the arrow keys to select among the items and press <Enter> to accept and enter the sub-menu.

**!! WARNING !!**

The information about BIOS defaults on manual (**Figure 1,2,3,4,5,6,7,8**) is just for reference, please refer to the BIOS installed on board, for update information.

■ **Figure 1. Main Menu**

CMOS Setup Utility-Copyright (C ) 1984-2000 Award Software

<ul style="list-style-type: none"> <li>▶ Standard CMOS Features</li> <li>▶ Advanced BIOS Features</li> <li>▶ Advanced Chipset Features</li> <li>▶ Integrated Peripherals</li> <li>▶ Power Management Setup</li> <li>▶ PnP/PCI Configurations</li> <li>▶ PC Health Status</li> </ul>	<ul style="list-style-type: none"> <li>Load Fail-Safe Defaults</li> <li>Load Optimized Defaults</li> <li>Set Supervisor Password</li> <li>Set User Password</li> <li>Save &amp; Exit Setup</li> <li>Exit Without Saving</li> </ul>
Esc : Quit      F9 : Menu in BIOS      ↑ ↓ → ← : Select Item F10 : Save & Exit Setup	
Time, Date, Hard Disk Type...	

**Standard CMOS Features**

This setup page includes all the items in a standard compatible BIOS.

**Advanced BIOS Features**

This setup page includes all the items of BIOS special enhanced features.

**Advanced Chipset Features**

This setup page includes all the items of chipset special features.

**Integrated Peripherals**

This section page includes all the items of IDE hard drive and Programmed Input/Output features.

**Power Management Setup**

This setup page includes all the items of power management features.

**PnP/PCI Configurations**

This setup page includes IRQ Setting by user define or default.

**PC Health Status**

This page shows the hardware Monitor information of the system.

**Load Fail-Safe Defaults**

Use this menu to load the BIOS default values for the minimal/stable performance for your system to operate. See section 8 for the details.

**Load Optimized Defaults**

These settings are more likely to configure a workable computer when something is wrong. If you cannot boot the computer successfully, select the BIOS Setup options and try to diagnose the problem after the computer boots. These settings do not provide optimal performance.

**Set Supervisor Password**

Change, set, or disable password. It allows you to limit access to the system and Setup, or just to Setup.

**Set User Password**

You can specify both a User and a Supervisor password. When you select either password option, you are prompted for a 1-6-character password. Enter the password and then retype the password when prompted.

**Save & Exit Setup**

Save CMOS value changes to CMOS and exit setup.

**Exit Without Saving**

Abandon all CMOS value changes and exit setup.

## 2.2 Standard CMOS Features

The items in Standard CMOS Setup Menu are divided into 10 categories. Each category includes no, one or more than one setup items. Use the arrow keys to highlight the item and then use the <PgUp> or <PgDn> keys to select the value you want in each item.

### ■ Figure 2. Standard CMOS Setup

CMOS Setup Utility-Copyright (C ) 1984-2000 Award Software  
Standard CMOS Features

Date (mm:dd:yy)	Tue, Feb 1 2000	Item Help
Time (hh:mm:ss)	11 : 26 : 10	
▶ IDE Primary Master	Press Enter None	Menu Level ▶
▶ IDE Primary Slave	Press Enter None	Change the day, month
▶ IDE Secondary Master	Press Enter None	year and century.
▶ IDE Secondary Slave	Press Enter None	
Drive A	1.44M, 3.5 in	
Drive B	None	
Video	EGA/VGA	
Halt On	All, But Keyboard	
Base Memory	XXXX	
Extended Memory	XXXX	
Total Memory	XXXX	

↑ ↓ → ← : Move Enter :Select +/-/PU/PD :Value F10 :Save ESC :Exit F1 :General Help  
F5 :Previous Values F6 :Fail-Safe Defaults F7 : Optimized Defaults

**Main Menu Selections**

This table shows the selections that you can make on the Main Menu.

<b>Item</b>	<b>Options</b>	<b>Description</b>
Date	Month DD YYYY	Set the system date. Note that the 'Day' automatically changes when you set the date.
IDE Primary Master	Options are in its sub menu.	Press <Enter> to enter the sub menu of detailed options
IDE Primary Slave	Options are in its sub menu.	Press <Enter> to enter the sub menu of detailed options.
IDE Secondary Master	Options are in its sub menu.	Press <Enter> to enter the sub menu of detailed options.
IDE Secondary Slave	Options are in its sub menu.	Press <Enter> to enter the sub menu of detailed options.
Drive A Drive B	None 360K, 5.25 in 1.2M, 5.25 in 720K, 3.5 in 1.44M, 3.5 in 2.88M, 3.5 in	Select the type of floppy disk drive installed in your system.
Video	EGA/VGA CGA 40 CGA 80 MONO	Select the default video device.



---

<b>Item</b>	<b>Options</b>	<b>Description</b>
Halt On	All Errors No Errors All, but Keyboard All, but Diskette All, but Disk/ Key	Select the situation in which you want the BIOS to stop the POST process and notify you.
Base Memory	N/A	Displays the amount of conventional memory detected during boot up.
Extended Memory	N/A	Displays the amount of extended memory detected during boot up.
Total Memory	N/A	Displays the total memory available in the sytem.

## 2.3 Advanced BIOS Features

### ■ Figure 3. Advanced BIOS Setup

CMOS Setup Utility-Copyright (C ) 1984-2000 Award Software  
Advanced BIOS Features

Full Logo Boot	<b>Enabled</b>	Item Help
Virus Warning	Disabled	
CPU Internal Cache	Enabled	Menu Level ►
External Cache	Enabled	
CPU L2 Cache ECC Checking	Enabled	Allows you to choose whether to display fullogo or text mode when booting
Quick Power On Self Test	Enabled	
First Boot Device	Floppy	
Second Boot Device	HDD-0	
Third Boot Device	LS/ZIP	
Boot Other Device	Enabled	
Swap Floppy Drive	Disabled	
Boot Up Floppy Seek	Enabled	
Boot Up NumLock Status	On	
Gate A20 Option	Fast	
Typematic Rate Setting	Disabled	
X Typematic Rate (Chars / Sec)	6	
X Typematic Delay (Msec)	250	
Security Option	Setup	
OS Select For DRAM > 64MB	Non-OS2	
Video BIOS Shadow	Enabled	

↑ ↓ → ← : Move    Enter :Select    +/-/PU/PD :Value    F10 :Save    ESC :Exit    F1 :General Help  
 F5 :Previous Values    F6 :Fail-Safe Defaults    F7 : Optimized Defaults

**Full Logo Boot**

This item allows you to choose whether show full logo or not.

**The Choices:** Enabled (default), Disabled.

**Virus Warning**

Allows you to choose the VIRUS Warning feature for IDE Hard Disk boot sector protection. If this function is enabled and someone attempts to write data into this area, BIOS will show a warning message on screen and alarm beep.

<b>Disabled</b> (default)	No warning message appears when anything attempts to access the boot sector or hard disk partition table.
<b>Enabled</b>	Activates automatically when the system boots up causing a warning message to appear when anything attempts to access the boot sector of hard disk partition table.

**CPU Internal Cache**

These two categories speed up memory access. However, it depends on CPU/chipset design.

<b>Enabled</b> (default)	Enable cache.
<b>Disabled</b>	Disable cache.

**External Cache**

These fields allow you to Enable or Disable the CPU's "Level 2" secondary cache. Caching allows better performance.

<b>Enabled</b> (default)	Enable cache.
<b>Disabled</b>	Disable cache.

**CPU L2 Cache ECC Checking**

This item allows you to enable/disable CPU L2 Cache ECC checking.

**The Choices:** Enabled (default), Disabled.

**Quick Power On Self Test**

This category speeds up Power on Self-Test (POST) after you power up the computer. If it is set to Enable, Bios will shorten or skip some check items during POST.

<b>Enabled</b> (default)	Enable quick POST.
--------------------------	--------------------

**Disabled**

Normal POST.

**First /Second/Third/ Boot Other Device**

These BIOS attempts to load the operating system from the devices in the sequence selected in these items.

**The Choices:** Floppy, LS/ZIP, HDD SCSI, CDROM, Enabled.

**Swap Floppy Drive**

If the system has two floppy drives, you can swap the logical drive name assignments.

**The Choices:** Enabled, Disabled (default).

**Boot Up Floppy Seek**

Seeks disk drives during boot up. Disabling speeds boot-up.

**The Choices:** Enabled (default), Disabled.

**Boot Up NumLock Status**

Select power on state for NumLock.

**On** (default)

Numpad is number keys.

**Off**

Numpad is arrow keys.

**Gate A20 Option**

Select if chipset or keyboard controller should control Gate A20.

**Normal**

A pin in the keyboard controller controls GateA20.

**Fast** (default)

Lets chipset control GateA20.

**Typematic Rate Setting**

Keystroke repeat at a rate determined by the keyboard controller. When enabled, the typematic rate and typematic delay can be selected.

**The Choices:** Enabled, Disabled (default).

**Typematic Rate (Chars / Sec)**

Sets the number of times a second to repeat a keystroke when you hold the key down.

**The Choices:** 6 (default), 8, 10, 12, 15, 20, 24, 30.

**Typematic Delay (Msec)**

Sets the delay time after the key is held down before it begins to repeat the keystroke.

**The Choices:** 250 (default), 500, 750, 1000.

**Security Option**

This category allows you to limit access to the system and Setup, or just to Setup.

<b>System</b>	The system will not boot and access to Setup will be denied if the correct password is not entered in prompt.
<b>Setup (default)</b>	The system will boot, but access to Setup will be denied if the correct password is not entered at the prompt.

**OS Select For DRAM > 64MB**

Select the operating system that is running with greater than 64MB of RAM on the system.

**The Choices:** Non-OS2 (default), OS2.

**Video BIOS Shadow**

Determine whether video BIOS will be copied to RAM for faster execution.

<b>Enabled (default)</b>	Optional ROM is enabled.
<b>Disabled</b>	Optional ROM is disabled.

## 2.4 Advanced Chipset Features

This section allows you to configure the system based on the specific features of the installed chipset. This chipset manages bus speeds and access to system memory resources, such as DRAM and the external cache. It also coordinates communications the PCI bus. It must be stated that these items should never need to be altered. The default settings have been chosen because they provide the best operating conditions for your system. The only time you might consider making any changes would be if you discovered that data was being lost while using your system.

### ■ Figure 4. Advanced Chipset Setup

CMOS Setup Utility-Copyright (C ) 1984-2000 Award Software  
Advanced Chipset Features

		Item Help
DRAM Clock	<b>100MHz</b>	
Memory Hole	Disabled	
System BIOS Cachesable	Disabled	Menu Level ►
Video RAM Cacheable	Disabled	
AGP Aperture Size	64M	
AGP-4X Mode	Enabled	
AGP Driving Control	Auto	
X AGP Driving Value	DA	
OnChip USB	Enabled	
USB Keyboard Support	Disabled	
OnChip Sound	Auto	
OnChip Modem	Auto	
Onboard Audio Device (Optional)	Enabled	
Memory Parity/ECC Check	Disabled	

↑ ↓ → ← : Move    Enter : Select    +/-/PU/PD : Value    F10 : Save    ESC : Exit    F1 : General Help  
 F5 : Previous Values    F6 : Fail-Safe Defaults    F7 : Optimized Defaults

### **DRAM Clock**

This configuration option allows you to set the DRAM clock speed with the following options.

**The Choices:** 100MHz (default), 133MHz, By SPD.

**Memory Hole**

You can reserve this area of system memory for ISA adapter ROM. When this area is reserved, it cannot be cached. The user information of peripherals that need to use this area of system memory usually discusses their memory requirements.

**The Choices:** Enabled, Disabled (default).

**System BIOS Cacheable**

Selecting Enabled allows caching of the system BIOS ROM at F0000h-FFFFFh, resulting in better system performance. However, if any program writes to this memory area, a system error may result.

**The Choices:** Enabled, Disabled (default).

**Video RAM Cacheable**

Same as system BIOS Cacheable.

**AGP Aperture Size (MB)**

This option determines the effective size of the graphics aperture used in the particular PAC configuration. The AGP aperture is memory mapped, while graphics data structure can reside in a graphics aperture. The aperture range should be programmed as not cacheable in the processor cache, accesses with the aperture range are forwarded via a translation table that is maintained on the main memory. The option allows the selection of an aperture of 4MB,8MB,16MB,32MB,64MB,128MB,or 256MB.

**AGP-4X Mode**

This item allows you to enable/disable the AGP-4X Mode.

**The Choices:** Enabled (default), Disabled.

**AGP Driving Control**

By choosing "Auto" the system BIOS will the AGP output Buffer Drive strength P Ctrl by AGP Card. By choosing "Manual", it allows user to set AGP output Buffer Drive strength P Ctrl by manual.



**AGP Driving Value**

While AGP driving control item set to "Manual", it allows user to set AGP driving.

**OnChip USB**

This should be enabled if your system has a USB installed on the system board and you wish to use it. Even when so equipped, if you add a higher performance controller, you will need to disable this feature.

**The Choices:** Enabled (default), Disabled.

**USB Keyboard Support**

Select Enabled is your system contains a Universal Serial Bus (USB) and you have a USB keyboard.

**The Choices:** Disabled (default), Enabled.

**OnChip Sound**

Then default setting of this item utilizes an onboard sound chip for audio output. There is no need to buy and insert a sound card. If sound card is installed, disable this item.

**OnChip Modem**

Then default setting of this item utilizes an onboard modem chip for audio output. There is no need to buy and insert a modem card. If modem card is installed, disable this item.

**Onboard Audio Device (Optional)**

The default setting of this item utilizes an onboard sound chip for audio output. There is no need to buy and insert a sound card. If sound card is installed, disable this item.

**Memory Parity/ECC Check**

Select Enabled if the DRAM chips in your system support parity.

**The Choices:** Disabled (default), Enabled.

## 2.5 Integrated Peripherals

■ **Figure 5. Integrated Peripherals**

CMOS Setup Utility-Copyright (C ) 1984-2000 Award Software  
 Integrated Peripherals

OnChip IDE Channel 0	<b>Enabled</b>	▲ ▼	Item Help
OnChip IDE Channel 1	Enabled		Menu Level ▶
IDE Prefetch Mode	Enabled		
Primary Master PIO	Auto		
Primary Slave PIO	Auto		
Secondary Master PIO	Auto		
Secondary Slave PIO	Auto		
Primary Master UDMA	Auto		
Primary Slave UDMA	Auto		
Secondary Master UDMA	Auto		
Secondary Slave UDMA	Auto		
Init Display First	PCI Slot		
IDE HDD Block Mode	Enabled		
Onboard FDD Controller	Enabled		
Onboard Serial Port 1	3F8/IRQ4		
Onboard Serial Port 2	2F8/IRQ3		
UART 2 Mode	Standard		
X IR Function Duplex	Half		
X TX, RX inverting enable	No, Yes		
Onboard Parallel Port	378/IRQ7		
Onboard Parallel Mode	EPP		
X ECP Mode Use DMA	3		
Parallel Port EPP Type	EPP1.9		
Onboard Legacy Audio (Optional)	Enabled		
Sound Blaster (Optional)	Disabled		
SB I/O Base Address (Optional)	220H		
SB IRQ Select (Optional)	IRQ 5		
SB DMA Select (Optional)	DMA 1		
MPU-401 (Optional)	Enabled		
MPU-401 I/O Address (Optional)	330-333H		
Game Port (200-207H) (Optional)	Enabled		

▲ : Move    Enter : Select    +/-/PU/PD : Value    F10 : Save    ESC : Exit    F1 : General Help  
 ▼ : Previous Values    F5 : Fail-Safe Defaults    F6 : Optimized Defaults

**OnChip IDE Channel 0/1**

The chipset contains a PCI IDE interface with support for two IDE channels. Select Enabled to activate the first and/or second IDE interface. Select Disabled to deactivate an interface, if you install a primary and/or secondary add-in ide interface.

**IDE Prefetch Mode**

The onboard IDE drive interfaces supports IDE prefetching, for faster drive access. If you install a primary and/or secondary add-in IDE interface, set this field to Disabled if the interface does not support prefetching.

**Init Display First**

This item allows you to decide to active whether PCI Slot or AGP Slot.

**The Choices:** PCI Slot (default), AGP.

**IDE HDD Block Mode**

Block mode is also called block transfer, multiple commands, or multiple sector read/write. If your IDE hard drive supports block mode (most new drives do), select Enabled for automatic detection of the optimal number of block mode (most new drives do), select Enabled for automatic detection of the optimal number of block read/writes per sector the drive can support.

**The Choices:** Enabled (default), Disabled

**Primary / Sedondary Master / Slave PIO**

The IDE PIO (Programmed Input / Output) fields let you set a PIO mode (0-4) for each of the IDE devices that the onboard IDE interface supports. Modes 0 through 4 provide successively increased performance. In Auto mode, the system automatically determines the best mode for each device.

**The Choices:** Auto (default), Mode0, Mode1, Mode2, Mode3, Mode4.

**Primary / Secondary Master / Slave UDMA**

Ultra DMA/33 implementation is possible only if your IDE hard drive supports it and the operating environment includes a DMA drive (Windows 95 OSR2 or a third party IDE bus master driver). If your hard drive and your system software both support Ultra DMA/33, Select Auto to enable BIOS support.

**The Choices:** Auto (default), Disabled.

**Onboard FDD Controller**

Select Enabled if your system has a floppy disk controller (FDC) installed on the system board and if you wish to use it. If install and FDC or the system has no floppy drive, select Disabled in this field.

**The Choices:** Enabled (default), Disabled.

**Onboard Serial Port 1/Port 2**

Select an address and corresponding interrupt for the first and second serial port.

**The Choices:** Disabled, Auto, (3F8/IRQ4), (2F8/IRQ3), (3E8/ IRQ4), (2E8 / IRQ3).

**UART 2 Mode**

This item allows you to determine which Infra Red (IR) function of the onboard I/O chip, you wish to use.

**IR Function Duplex**

This item allows you to determine which Infra Red (IR) function of onboard I/O chip.

**The Choice: Half** (default).

**TX, RX inverting enable**

This item allows you to determine the active of Rx, Tx.

**Onboard Parallel Port**

This item allows you to determine access onboard parallel port controller with which I/O address.

**Onboard Parallel Mode**

Select an operating mode for the onboard parallel (printer) port. Normal EPP (Extended Parallel Port) ECP (Extended Capabilities Port) ECP+EPP PC AT parallel port Bidirectional Port Fast, buffered port Fast, buffered, Bidirectional Port. Select Normal unless you are certain your hardware and software both support EPP or ECP mode.

**ECP Mode Use DMA**

Select a DMA channel for the parallel port for use during ECP mode.

**The Choices:** 3 (default), 1.

**Parallel Port EPP Type**

Select a DMA Channel for the port.

**The Choices:** EPP1.9 (default), EPP1.7.

**Onboard Legacy Audio (Optional)**

Select an operating mode for the second serial port:

**The Choices:** Enabled (default), Disabled.

**Sound Blaster (Optional)**

Hardware the SoundBlaster Pro for Windows DOS box and real-mode DOS legacy compatibility.

**SB I/O Base Address (Optional)**

Change the SoundBlaster Pro Base I/O Address setting.

**SB IRQ Select (Optional)**

Change the SoundBlaster Pro interrupt signal.

**SB DMA Select (Optional)**

Change the SoundBlaster Pro direct memory access setting.

**MPU-401 (Optional)**

Enable or Disable MPU-401 option.

**MPU-401 I/O Address (Optional)**

Change the SoundBlaster Pro MPU-401 I/O address.

**Game Port (200-207H) (Optional)**

Change the joystick connect port address.

## 2.6 Power Management Setup

The Power Management Setup allows you to configure your system to most effectively save energy while operating in a manner consistent with your own style of computer use.

### ■ Figure 6. Power Management Setup

CMOS Setup Utility-Copyright (C ) 1984-2000 Award Software  
Power Management Setup

ACPI function	Enabled	Item Help
ACPI Suspend Type	<b>S1(POS)</b>	
Power Management	User Define	Menu Level ▶
PM Control by APM	Yes	
Video Off Option	Suspend -> Off	
Video Off Method	V/H SYNC+Blank	
Modem Use IRQ	3	
Soft-Off by PWR-BTTN	Instant-Off	
HDD Power Down	Disabled	
Suspend Mode	Disabled	
VGA	OFF	
LPT & COM	LPT/COM	
HDD & FDD	ON	
PCI Master	OFF	
Wake Up On LAN/Ring	Disabled	
RTC Alarm Resume	Disabled	
X Date (of Month)	0	
X Resume Time (hh:mm:ss)	0 0 0	

↑ ↓ → ← : Move Enter :Select +/-/PU/PD :Value F10 :Save ESC :Exit F1 :General Help  
F5 :Previous Values F6 :Fail-Safe Defaults F7 : Optimized Defaults

### ACPI function

This item display status of the Advanced Configuration and Power Management (ACPI).

**ACPI Suspend Type**

The item allows you to select the suspend type under ACPI operating system.

**S1 (POS)** (default) Power on Suspend  
**S3 (STR)** Suspend to RAM

**Power Management**

This category allows you to select the type (or degree) of power saving and is directly related to the following modes:

1. HDD Power Down.
2. Suspend Mode.

There are four selections for Power Management, three of which have fixed mode Setting.

<b>Min. Power Saving</b>	Minimum power management. Standby Mode = 1 hr., Suspend Mode = 1 hr., and HDD Power Down = 15 min.
<b>Max. Power Saving</b>	Maximum power management—only available for CPU's. Standby Mode = 1 min., Suspend Mode = 1 min., and HDD Power Down = 1 min.
<b>User Defined</b> (default)	Allows you to set each mode individually. When not disabled, each range is from 1 min. to 1 hr. except for HDD Power Down which ranges from 1 min. to 15 min. and disable.

**PM Control by APM**

<b>No</b>	System BIOS will ignore APM when power Management is on.
<b>Yes</b> (default)	System Bios will wait for APM's prompt before it enters any PM mode.

**Video Off Option**

This field determines when to activate the video off feature for monitor power management.

**Video Off Method**

This determines the manner in which the monitor is blanked.

<b>V/H SYNC+Blank</b> (default)	This selection will cause the system to turn off the vertical and horizontal synchronization ports and write blanks to the video buffer.
<b>Blank Screen</b>	This option only writes blanks to the video buffer.
<b>DPMS</b>	Initial display power management signaling.

**Modem Use IRQ**

This determines the IRQ, which can be applied in MODEM use.

**3** is (default)  
**4 / 5 / 7 / 9 / 10 / 11 / NA**

**Soft-Off by PWR-BTTN**

Pressing the power button for more than 4 seconds forces the system to enter the Soft-Off state when the system has "hung."

**The Choices:** Delay 4 Sec, Instant-Off (default)

**HDD Power Down**

When enabled and after the set time of system inactivity, the hard disk drive will be powered down while all other devices remain active.

**Disabled** (default)  
**Enabled**

**Suspend Mode**

The Suspend Mode fields set the Period of time, after which each of these modes activate. At *Max Saving*, these modes activate sequentially (in the given order) after one minute; at *Min Saving* after one hour.

**VGA**

When set to On, any event occurring at a COM(serial)/LPT (printer) Port will awaken a system which has been powered down.



**LPT & COM**

When set to On, any event occurring at a COM(serial)/LPT (printer) port will awaken a system which has been powered down.

**HDD & FDD**

When set to On(default), any event occurring at a hard or floppy drive will awaken a system which has been powered down.

**PCI Master**

When set to On, you need a LAN add-on card which support power on function. It should also support the wake-up on LAN jump.

**Wake Up On LAN/Ring**

To use this function, you need a LAN add-on card which support power on function. It should also support the wake-up on LAN jump.

**Disabled** (default) Wake up on LAN/Ring not supported.

**RTC Alarm Resume**

When Enabled, you can set the date and time at which the RTC (real-time clock) alarm awakens the system from Suspend mode.

**Date (of Month)**

You can choose which month the system will boot up.

**Resume Time (hh:mm:ss)**

You can choose what hour, minute and second the system will boot up.

## 2.7 PnP/PCI Configurations

This section describes configuring the PCI bus system. PCI, or Personal Computer Interconnect, is a system which allows I/O devices to operate at speeds nearing the speed of the CPU itself uses when communicating with its own special components. This section covers some very technical items and it is strongly recommended that only experienced users should make any changes to the default settings.

### ■ Figure 7. PnP/PCI Configurations

CMOS Setup Utility-Copyright (C ) 1984-2000 Award Software  
PnP/PCI Configurations

PNP OS Installed	<b>No</b>	Item Help	
Reset Configuration Data	Disabled		
Resources Controlled By	Auto (ESCD)	Menu Level ▶	
X IRQ Resources	Press Enter	Select Yes if you are using a Plug and Play capable operating system. Select No if you need the BIOS to configure non-boot devices	
X DMA Resources	Press Enter		
PCI/VGA Palette Snoop	Disabled		
Assign IRQ For VGA	Enabled		
Assign IRQ For USB	Enabled		
↑ ↓ → ← : Move Enter :Select +/-/PU/PD :Value F10 :Save ESC :Exit F1 :General Help F5 :Previous Values F6 :Fail-Safe Defaults F7 : Optimized Defaults			

### **PNP OS Installed**

When set to YES, BIOS will only initialize the PnP cards used for booting (VGA, IDE, SCSI). The rest of the cards will be initialized by the PnP operating system like Window™ 9X/2000. When set to NO, BIOS will initialize all the PnP cards. Therefore for non-PnP operating system (DOS, Netware™), this option must set to NO.

### **Reset Configuration Data**

The system BIOS supports the PnP feature so the system needs to record which resource is assigned and proceeds resources from conflict. Every peripheral device has a node, which is called ESCD. This node records which resources are assigned to it. The system needs to record and update ESCD to the memory locations. These locations (4K) are reserved at the system BIOS. If Disabled (default) is chosen, the system's ESCD will update only when the new configuration varies from the last one. If Enabled is chosen, the system is forced to update ESCDs and then is automatically set to the "Disabled" mode.

IRQ-3	assigned to: PCI / ISA PnP
IRQ-4	assigned to: PCI / ISA PnP
IRQ-5	assigned to: PCI / ISA PnP
IRQ-7	assigned to: PCI / ISA PnP
IRQ-9	assigned to: PCI / ISA PnP
IRQ-10	assigned to: PCI / ISA PnP
IRQ-11	assigned to: PCI / ISA PnP
IRQ-12	assigned to: PCI / ISA PnP
IRQ-14	assigned to: PCI / ISA PnP
IRQ-15	assigned to: PCI / ISA PnP
DMA-0	assigned to: PCI / ISA PnP
DMA-1	assigned to: PCI / ISA PnP
DMA-3	assigned to: PCI / ISA PnP
DMA-5	assigned to: PCI / ISA PnP
DMA-6	assigned to: PCI / ISA PnP
DMA-7	assigned to: PCI / ISA PnP

The above settings will be shown on the screen only if "Manual" is chosen for the resources controlled by function.

Legacy is the term, which signifies that a resource is assigned to the ISA Bus and provides for non-PnP ISA add-on cards. PCI / ISA PnP signifies that a resource is assigned to the PCI Bus or provides for ISA PnP add-on cards and peripherals.

### **Resources Controlled By**

By Choosing "Auto" (default), the system BIOS will detect the system resources and automatically assign the relative IRQ and DMA channel for each peripheral.

By Choosing "Manual", the user will need to assign IRQ & DMA for add-on cards. Be sure that there are no IRQ/DMA and I/O port conflicts.

**IRQ Resources**

When resources are controlled manually, assign each system interrupt a type, depending on the type of device using the interrupt.

**DMA Resources**

When resources are controlled manually, assign each system DMA channel a type, depending on the type of device using the DMA channel.

**PCI/VGA Palette Snoop**

Choose Disabled or Enabled. Some graphic controllers which are not VGA compatible take the output from a VGA controller and map it to their display as a way to provide boot information and VGA compatibility.

However, the color information coming from the VGA controller is drawn from the palette table inside the VGA controller to generate the proper colors, and the graphic controller needs to know what is in the palette of the VGA controller. To do this, the non-VGA graphic controller watches for the Write access to the VGA palette and registers the snoop data. In PCI based systems, where the VGA controller is on the PCI bus and a non-VGA graphic controller is on an ISA bus, the Write Access to the palette will not show up on the ISA bus if the PCI VGA controller responds to the Write.

In this case, the PCI VGA controller should not respond to the Write, it should only snoop the data and permit the access to be forwarded to the ISA bus. The non-VGA ISA graphic controller can then snoop the data on the ISA bus. Unless you have the above situation, you should disable this option.

<b>Disabled</b> (default)	Disables the function.
<b>Enabled</b>	Enables the function.

**Assign IRQ For VGA**

Lets the user choose which IRQ to assign for the VGA.

**Assign IRQ For USB**

Lets the user choose which IRQ to assign for the VGA.

## 2.8 PC Health Status

### ■ Figure 8. PC Health Status

CMOS Setup Utility-Copyright (C ) 1984-2000 Award Software  
PC Health Status

Show H/W Monitor in POST <b>3 sec</b> Current CPU Temp. Current System Temp. Current CPUFAN Speed Current SYSFAN Speed Vcore VccSRAM 3.3V 5V 12V	Item Help Menu Level ►
---	---------------------------

↑ ↓ → ← : Move Enter :Select +/-/PU/PD :Value F10 :Save ESC :Exit F1 :General Help  
 F5 :Previous Values F6 :Fail-Safe Defaults F7 : Optimized Defaults

#### **Show H/W Monitor in POST**

If your computer contains a monitoring system, it will show PC health status during POST stage. The item offers several delay times for you to choose.

**3 sec** (default)

#### **Current CPU Temp.**

This field displays the *current* CPU temperature, if your computer contains a monitoring system.

#### **Current System Temp.**

This field displays the *current* system temperature, if your computer contains a monitoring system.

#### **Current CPUFAN Speed**

These fields display the current speed of up to three CPU fans, if your computer contains a monitoring system.

#### **Current CPU Vcore VccSRAM, 3.3V, 5V, 12V**

Detect system's voltage status automatically.

## 2.9 Load Fail-Safe Defaults

When you press <Enter> on this item, you get a confirmation dialog box with a message similar to:

### ■ Figure 9. Load Fail-Safe Defaults

CMOS Setup Utility-Copyright (C ) 1984-2000 Award Software

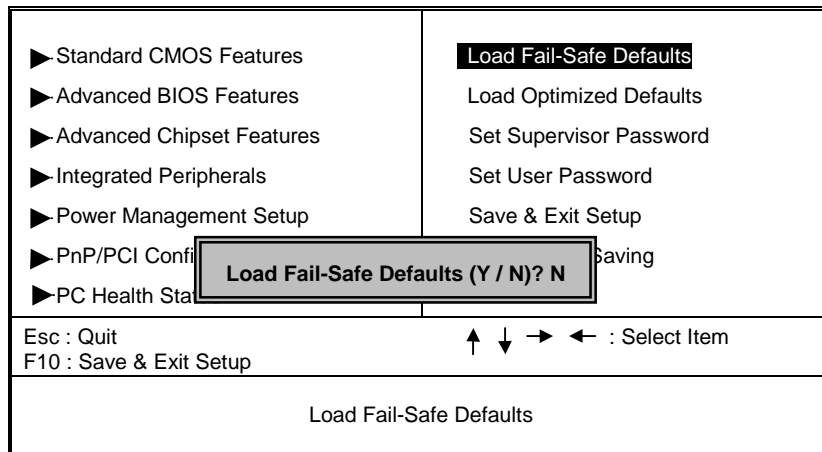

Pressing 'Y' loads the default values that are factory settings for optimal performance system operations.

## 2.10 Load Optimized Defaults

When you press <Enter> on this item, you get a confirmation dialog box with a message similar to:

### ■ Figure 10. Load Optimized Defaults

CMOS Setup Utility-Copyright (C ) 1984-2000 Award Software

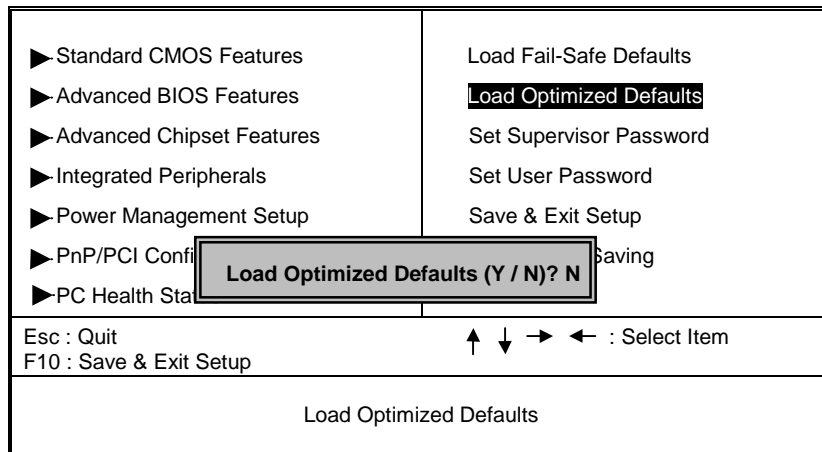

Pressing 'Y' loads the default values that are factory settings for optimal performance system operations.



## 2.11 Set Supervisor / User Password

### ■ Figure 11. Set Supervisor / User Password

CMOS Setup Utility-Copyright (C ) 1984-2000 Award Software

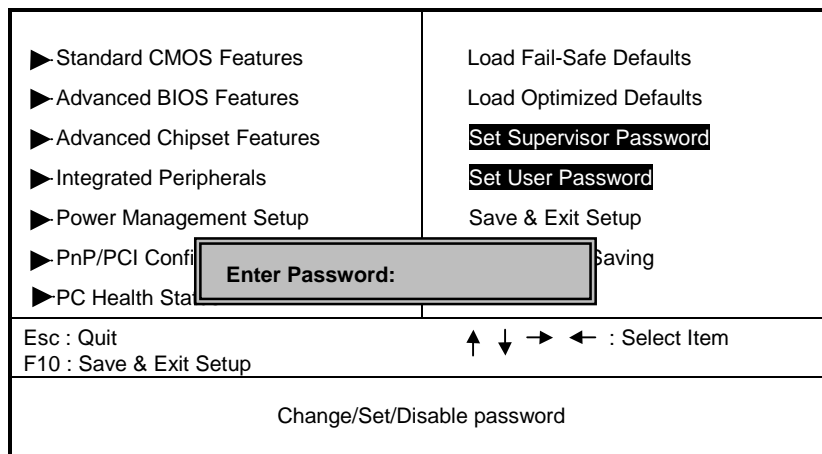

When you select this function, the following message will appear at the center of the screen to assist you in creating a password.

#### ENTER PASSWORD

Type the password, up to eight characters, and press <Enter>. The password you type now will clear any previously entered password from CMOS memory. You will be asked to confirm the password. Type the password again and press <Enter>. You may also press <ESC> to abort the selection and not enter a password. To disable password, just press <Enter> when you are prompted to enter password. A message will confirm that you wish to disable the password. Once the password is disabled, the system will boot and you can enter setup freely.

**PASSWORD DISABLED**

If you select “System” at the Security Option of BIOS Features Setup Menu, you will be prompted for the password every time when the system is rebooted, or any time when you try to enter Setup. If you select “Setup” at Security Option of BIOS Feature Setup Menu, you will be prompted only when you try to enter Setup.

## 2.12 Save & Exit Setup

### ■ Figure 12. Save & Exit Setup

CMOS Setup Utility-Copyright (C ) 1984-2000 Award Software

▶ Standard CMOS Features	Load Fail-Safe Defaults
▶ Advanced BIOS Features	Load Optimized Defaults
▶ Advanced Chipset Features	Set Supervisor Password
▶ Integrated Peripherals	Set User Password
▶ Power Management Setup	<b>Save &amp; Exit Setup</b>
▶ PnP/PCI C	Saving
▶ PC Health	
<b>SAVE to CMOS and EXIT (Y/N)? Y</b>	
Esc : Quit	↑ ↓ → ← : Select Item
F10 : Save & Exit Setup	
Save Data to CMOS	

Type "Y" will quit the Setup Utility and save the user setup value to RTC CMOS RAM.

Type "N" will return to Setup Utility.

## 2.13 Exit Without Saving

### ■ Figure 13. Exit Without Saving

CMOS Setup Utility-Copyright (C ) 1984-2000 Award Software

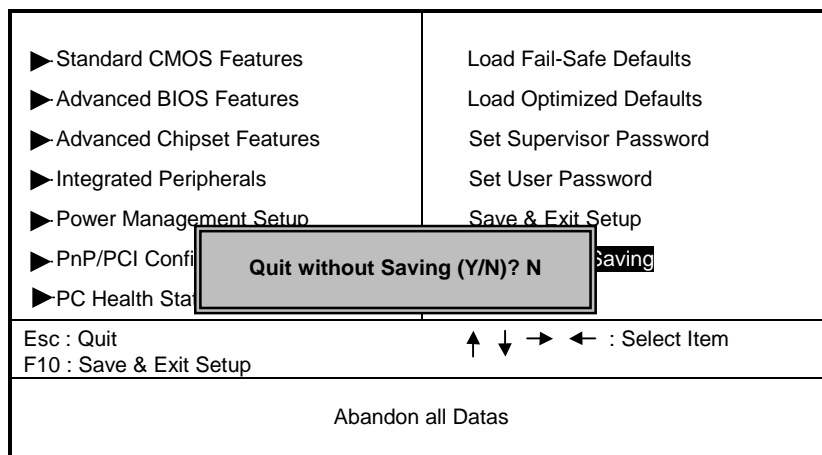

Type "Y" will quit the Setup Utility without saving to RTC CMOS RAM.  
Type "N" will return to Setup Utility.

## 3. Software Setup

NOTE: The mark \* means it can be installed directly from CD by using CD Installation Utility ( i.e. START.EXE).

### 3.1 Software List

Category	Description	Platform	Location in CD
VIA 4-in-1 Drive *	1. VIA IDE Bus Master Driver Install the drivers to support Ultra DMA mode Hard Drive. 2. VIA AGP Driver Install the drivers to support AGP interface VGA Card. 3. IRQ Routing Driver Used for enable PCI bus IRQ Steering function. 4. VIA ACPI Registry Used for patching Windows Registry System to let Windows recognizes new devices.	Windows 95/98/NT4.0	\Mb_drv\Service
VIA Hardware Monitor *	VIA Hardware Monitor is a self-diagnostic system for PC.	Windows 95/98/NT4.0 / 2000	\Mb_drv\Sysdiag
HighPoint XStore Pro *	Install the drivers to support Ultra DMA mode Hard Drive.	Windows 95/98	\Mb_drv\Xstore
DirectX 7.0*	Install Microsoft DirectX 7.0 for Windows	Windows 95/98/NT/2000	\DirectX
VIA AC97 Audio*	Install the driver to enable the VIA AC97 Audio Device	DOS, Windows 95/98/NT4.0 / 2000	\Audio\VIA

---

Aureal Vortex Au8810 Audio*	Install the driver to enable the Aureal Audio device	Windows 95/98/NT4.0 / 2000	\\Audio\\Aureal
Creative SB PCI128 Audio*	Install the driver to enable the Creative Audio Device	Windows 95/98/NT4.0 /2000	\\Audio\\Creative
Award Flash Utility	Used for updating BIOS.		\\Flash

## 3.2 Software Installation

We provide an installation wizard, Driver CD Installation Utility (START.EXE), located in the root of Driver CD to let users install some common used drivers conveniently.

➤ **The drivers can be installed from CD by using CD Installation Utility:**

You can simply put Driver CD into CD-ROM drive and the Installation Utility will autorun or you can run the Driver CD Installation Utility directly by using mouse cursor to click the proper option on the page. Utility will invoke other applications to complete the rest of installation.

➤ **The drivers CAN NOT be installed directly from CD by using CD Installation Utility:**

Please read the README.TXT located in the root directory on Multimedia CD to get drivers' location and then refer to the INSTALL.TXT or README.TXT files located in each driver directory on the Driver CD to install drivers.

### 3.3 Using Software

- In general, you can get more detailed information in the on-line help or readme for the softwares.

- **Using VIA Hardware Monitor**

After the utility is installed, you can follow the sequence, **Start -> Program -> VIA HM -> VIA Hardware Monitor**, to launch the monitor application.

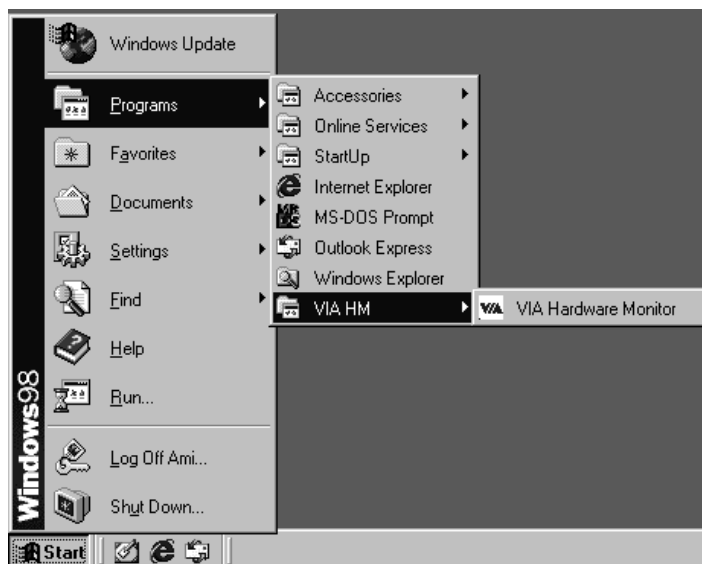

The following figure is the main panel of VIA Hardware Monitor. In the panel, you can get some real-time and important information -- Voltage, Fan speed, and temperature, for example. If there is an abnormal situation, you can resolve it immediately.

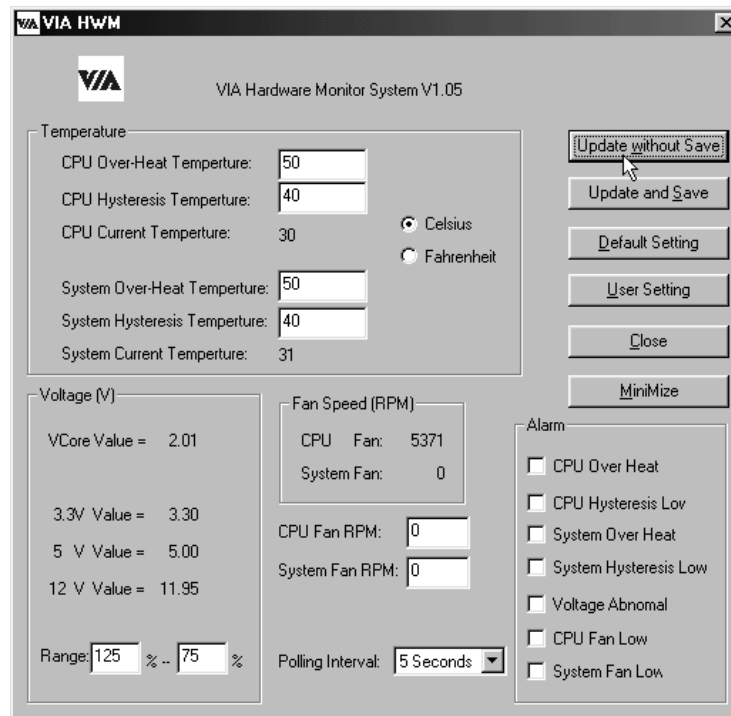



## 4. Trouble shooting

### **PROBLEM**

No power to the system at all. Power light does not illuminate, fan inside power supply does not turn on. Indicator light on keyboard does not turn on.

<b>PROBABLE CAUSE</b>	<b>DIAGNOSIS</b>	<b>SOLUTION</b>
Power cable is unplugged.	Visually inspect power cable.	Make sure power cable is securely plugged in.
Defective power cable.	Visually inspect the cable; try another cable.	Replace cable.
Power supply failure.	Power cable and wall socket are OK, but system is still dead.	Contact technical support.
Faulty wall outlet; circuit breaker or fuse blown.	Plug in device known to work in socket and test	Use different socket, repair outlet, reset circuit breaker or replace fuse.

### **PROBLEM**

System inoperative. Keyboard lights are on, power indicator lights are lit, hard drive is spinning.

<b>PROBABLE CAUSE</b>	<b>DIAGNOSIS</b>	<b>SOLUTION</b>
Memory DIMM is partially dislodged from the slot on the motherboard.	Turn off computer. Take cover off system unit. Check the DIMM to ensure it is securely seated in the slot.	Using even pressure on both ends of the DIMM, press down firmly until the module snaps into place.

**PROBLEM**

System does not boot from hard disk drive, can be booted from CD-ROM drive.

<b>PROBABLE CAUSE</b>	<b>DIAGNOSIS</b>	<b>SOLUTION</b>
Connector between hard drive and system board unplugged.	When attempting to run the FDISK utility you get a message, INVALID DRIVE SPECIFICATION.	Check cable running from disk to disk controller board. Make sure both ends are securely plugged in; check the drive type in the standard CMOS setup.
Damaged hard disk or disk controller.	Format hard disk; if unable to do so the hard disk may be defective.	Contact technical support.
Hard disk directory or FAT is scrambled.	Run the FDISK program, format the hard drive. Copy data that was backed up onto hard drive.	Backing up the hard drive is extremely important. All hard disks are capable of breaking down at any time.

**PROBLEM**

System only boots from CD-ROM. Hard disk can be read and applications can be used but booting from hard disk is impossible.

<b>PROBABLE CAUSE</b>	<b>DIAGNOSIS</b>	<b>SOLUTION</b>
Hard Disk boot program has been destroyed.	A number of causes could be behind this.	Back up data and applications files. Reformat the hard drive. Re-install applications and data using backup disks.

**PROBLEM**

Error message reading “SECTOR NOT FOUND” or other error messages not allowing certain data to be retrieved.

<b>PROBABLE CAUSE</b>	<b>DIAGNOSIS</b>	<b>SOLUTION</b>
A number of causes could be behind this.	Use a file by file backup instead of an image backup to backup the hard disk.	Back up any salvageable data. Then low level format, partition, and high level format the hard drive. Re-install all saved data when completed.

**PROBLEM**

Screen message says “Invalid Configuration” or “CMOS Failure.”

<b>PROBABLE CAUSE</b>	<b>DIAGNOSIS</b>	<b>SOLUTION</b>
Incorrect information entered into the configuration (setup) program.	Check the configuration program. Replace any incorrect information.	Review system's equipment . Make sure correct information is in setup.

**PROBLEM**

Screen is blank.

<b>PROBABLE CAUSE</b>	<b>DIAGNOSIS</b>	<b>SOLUTION</b>
No power to monitor.		Check the power connectors to monitor and to system. Make sure monitor is connected to display card.
Monitor not connected to computer.		See instructions above.

**PROBLEM**

<b>PROBABLE CAUSE</b>	<b>DIAGNOSIS</b>	<b>SOLUTION</b>
Memory problem.		Reboot computer. Reinstall memory, make sure that all memory modules are installed in correct sockets.
Computer virus.		Use anti-virus programs to detect and clean viruses.

**PROBLEM**

Screen goes blank periodically.

<b>PROBABLE CAUSE</b>	<b>DIAGNOSIS</b>	<b>SOLUTION</b>
Screen saver is enabled.		Disable screen saver.

**PROBLEM**

Keyboard failure.

<b>PROBABLE CAUSE</b>	<b>DIAGNOSIS</b>	<b>SOLUTION</b>
Keyboard is disconnected.		Reconnect keyboard. Check keys again, if no improvement replace keyboard.

**PROBLEM**

No color on screen.

<b>PROBABLE CAUSE</b>	<b>DIAGNOSIS</b>	<b>SOLUTION</b>
Faulty Monitor.		If possible, connect monitor to another system. If no color replace monitor.
CMOS incorrectly set up.		Call technical support.

**PROBLEM**

C: drive failure.

<b>PROBABLE CAUSE</b>	<b>DIAGNOSIS</b>	<b>SOLUTION</b>
Hard drive cable not connected properly.		Check hard drive cable.

**PROBLEM**

Cannot boot system after installing second hard drive.

<b>PROBABLE CAUSE</b>	<b>DIAGNOSIS</b>	<b>SOLUTION</b>
Master/slave jumpers not set correctly.		Set master/slave jumpers correctly.
Hard drives not compatible / different manufacturers.		Run SETUP program and select correct drive types. Call drive manufacturers for compatibility with other drives.

**PROBLEM**

Missing operating system on hard drive.

<b>PROBABLE CAUSE</b>	<b>DIAGNOSIS</b>	<b>SOLUTION</b>
CMOS setup has been changed.		Run setup and select correct drive type.

**PROBLEM**

Certain keys do not function.

<b>PROBABLE CAUSE</b>	<b>DIAGNOSIS</b>	<b>SOLUTION</b>
Keys jammed or defective.		Replace keyboard.

**PROBLEM**

Keyboard is locked, and no keys function.

<b>PROBABLE CAUSE</b>	<b>DIAGNOSIS</b>	<b>SOLUTION</b>
Keyboard is locked.		Unlock keyboard.

04/08/2000  
MADE IN TAIWAN  
R.O.C