Federal Communications Commission (F.C.C) Statement

This device complies with Part 15 of the FCC Rules. Operation of this device is subject to the following two conditions: (1) this device may not cause harmful interference, and (2) this device must accept any interference received, including interference that may cause undesired operation.

Accessories: This device has been tested and found to comply with the limits of a Class B digital device, the accessories associated with this equipment are as follows:

1. Shielded serial cable. (Can be obtained from multiple retail outlets)
2. Shielded printer cable. (Can be obtained from multiple retail outlets)
3. Shielded video cable. (Can be obtained from multiple retail outlets)
4. Shielded power cord. (Provided by manufacturer)

These accessories are required to be used in order to ensure compliance with FCC Rules. It is the responsibility of the user to provide and use these accessories properly.

This equipment has been tested and found to comply with the limits of a Class B digital device, pursuant to Part 15 of the FCC Rules. These limits are designed to provide reasonable protection against harmful interference in a residential installation. This equipment generates, uses and can radiate radio frequency energy and, if not installed and used in accordance with the instructions, may cause harmful interference to radio communications. However, there is no guarantee that interference will not occur in a particular installation. If this equipment does cause harmful interference to radio or television reception, which can be determined by turning the equipment off and on, the user is encouraged to try to correct the interference by one or more of the following measures:

1. Reorient / Relocate the receiving antenna.
2. Increase the separation between the equipment and receiver.
3. Connect the equipment into an outlet on a circuit different from that to which the receiver is connected.
4. Consult the dealer or an experienced radio/TV technician for help.

Caution: Changes or modifications not expressly approved by the manufacturer could void the user's authority to operate the equipment.

Disclaimer

The Vendor makes no representations or warranties with respect to the contents here of and specially disclaims any implied warranties of merchantability or fitness for any purpose. Further the Vendor reserves the right to revise this publication and to make changes from time to time in the contents here of without obligation to notify any party beforehand.

Duplication of this publication, in part or in whole, is not allowed without first obtaining the Vendor's approval in writing.

Trademarks and Remarks

MS-DOS, Windows, Windows NT, and Windows 95 are products of Microsoft Corp, with its ownership of trademark, and are distributed by the Vendor under a license agreement.

All trademarks used in this manual are the property of their respective owners.

Copyright(C) 1992

All Rights Reserved

Canadian D.O.C. Statement

This digital apparatus does not exceed the Class B limits for radio noise emissions from digital apparatus as set out in the radio interference regulations of the Canadian Department of Communications.

Cet appareil numérique n'émet pas de bruits radioélectriques dépassant les limites appliqués aux appareils numériques de Class B prescrits dans le règlement du brouillage radioélectrique édicté par le ministre Des Communications du Canada.

Contents

Introduction	1-1
1 Motherboard Description	1-2
1.1 Features	1-2
1.1.1 Hardware	1-2
1.1.2 Software	1-4
1.1.3 Attachments	1-4
1.2 Motherboard Installation	1-5
1.2.1 Layout of Motherboard	1-5
1.3 Motherboard Connectors	1-6
1.3.1 Front Panel Connectors (JP8)	1-7
1.3.2 Floppy Disk Connector (FDD)	1-8
1.3.3 Hard Disk Connectors (IDE 1 / 2)	1-8
1.3.4 ATX 20-pin Power Connector (PWR1)	1-9
1.4 Serial and Parallel Interface Ports	1-10
1.4.1 Parallel Interface Ports (LPT1)	1-14
1.5 CPU Installation	1-15
1.5.1 CPU Installation Procedure	1-15
1.5.2 CPU Clock Selection (SW1)	1-18
1.6 Jumper Settings	1-19
1.6.1 Wake-On-LAN Header (JP4)	1-20
1.6.2 Internal Modem Ring (JP5)	1-20
1.6.3 Front USB Connectors (JP6)	1-20

Contents

1.6.4 CMOS Function Selection (JP9)	1-21
1.6.5 CPU Cooling Fan Power Connector (JP10)	1-21
1.7 DRAM Installation.....	1-22
1.7.1 DIMM	1-22
1.7.2 How to install a DIMM Module.....	1-23
1.8 VGA Introduction	1-24
1.9 Super-AGP Architecture	1-24
1.10 2D/3D Graphics Accelerator.....	1-25
1.11 Display Memory.....	1-26
1.12 Resolution	1-26
1.13 Video Accelerator	1-26
2. BIOS Setup.....	2-1
2.1 Main Menu.....	2-3
2.2 Standard CMOS Setup	2-5
2.3 BIOS Features Setup	2-10
2.4 Chipset Features Setup	2-15
2.5 Power Management Setup.....	2-17
2.6 PNP / PCI Configuration Setup.....	2-22
2.7 Load Setup Defaults.....	2-25
2.8 Integrated Peripherals Setup	2-26
2.9 Password Setting	2-30
2.10 IDE HDD Auto Detection.....	2-32
2.11 Save & Exit Setup	2-33

Contents

2.12 Exit Without Saving	2-34
2.13 Application Software	2-35
3. Software.....	3-1
3.1 Motherboard Software	3-1
3.1.1 Software List	3-1
3.1.2 Software Installation.....	3-2
3.1.3 Using Software	3-3
4. Trouble Shooting	4-1

Introduction

System Overview

Thanks for buying this product! This manual was written to help you start using this product as quickly and smoothly as possible. Inside you will find adequate explanations to solve most problems. In order for this reference material to be of greatest use, refer to the “expanded table of contents” to find relevant topics.

The board incorporates system board, ISA I/O, fast IDE on one board that provides all the PC solutions. The motherboard is a Pentium II™ or Celeron™ micro processor based PC/AT system, supports ISA Bus and PCI Local Bus and onboard 3D / 2D graphics accelerator to upgrade your system performance. It is ideal for multi-tasking and fully supports MS-DOS, Windows, Windows NT, Novell, OS/2, Windows9x, UNIX, SCO UNIX etc. This manual also explains how to install the motherboard for operation, and how to setup your CMOS configuration with BIOS setup program.

1 Motherboard Description

1.1 Features

1.1.1 Hardware

CPU

- The Pentium II™ / Pentium III™ /Celeron™ Processor provides the new generation power for high-end workstations and servers.
- Provides Slot 1.

Speed

- Supports CPU bus frequency 66MHz/100MHz.
- Supports from 233MHz to 500MHz CPU core speeds.
- Supports 33MHz PCI Bus speed.
- I/O clock 8MHz for ISA Bus.

DRAM Memory

- Supports three 8/16/32/64/128....MB, 3.3V / Unbuffered DIMM module sockets.
- Supports Synchronous DRAM.
- Supports a maximum memory size of 384MB with SDRAM.

Flash Memory

- Supports flash memory.
- Supports ESCD Function.

Shadow RAM

- A memory controller that provides shadow RAM and supports 8-bit ROM BIOS.

Green Function

- Supports power management operation via BIOS.
- Power down timer by APM.
- Wakes up by any key pressed, mouse activity, modem ring-in or wake-on LAN.

BUS Slots

- Provides four PCI Bus slots and two share ISA slots.

Fast IDE Built-in On Board

- Supports 4 IDE hard disk drives.
- Supports PIO mode 0,1,2,3,4, Master Mode, high performance hard disk drives.
- Supports Ultra DMA/33/66, Bus Master Mode.
- Supports Multiword DMA Mode 0,1,2.

ISA I/O Built-in Onboard

- Supports one multi-mode Parallel Port.
 - (1) Standard & Bidirection Parallel Port.
 - (2) Enhanced Parallel Port (EPP).
 - (3) Extended Capabilities Port (ECP).
- Supports two serial ports, 16550 UART with 16 byte FIFO.
- Supports one Infrared transmission (IR) port.
- Supports PS/2 Mouse , AT Keyboard.
- Supports 360KB, 720KB, 1.2MB, 1.44MB and 2.88MB floppy disk drives.

Hardware Monitor Subsystem

The hardware monitor subsystem provides low-cost instrumentation capabilities. The features of the hardware monitor subsystem include:

- Up to 4 positive Voltage (Vcc,Vcc3,Vcc2.5,Vcc Core)monitoring inputs.
- One Fan speed monitoring input.
- One Temperature Sensing.

Universal Serial Bus

- Supports two Universal Serial Bus (USB) Ports.
- Supports over current detertion.

Dimension

- 22 cm X 22 cm (W x L)

1.1.2 Software

BIOS

- AWARD legal BIOS.
- Supports APM1.2.
- Supports USB Function.
- Supports ACPI.

Operating System

- Offers the highest performance for MS-DOS, OS/2, Windows 3x, Windows NT, Windows 9x, Novell, UNIX, SCO UNIX etc.

1.1.3 Attachments

- HDD Cable
- FDD Cable
- Serial Port Cable
- CD for VGA, IDE drivers and utilities.
- USB cable (optional)
- PS/2 Mouse Cable (optional)
- VGA Cable (optional)

1.2 Motherboard Installation

1.2.1 Layout of Motherboard Model No.M6SBC

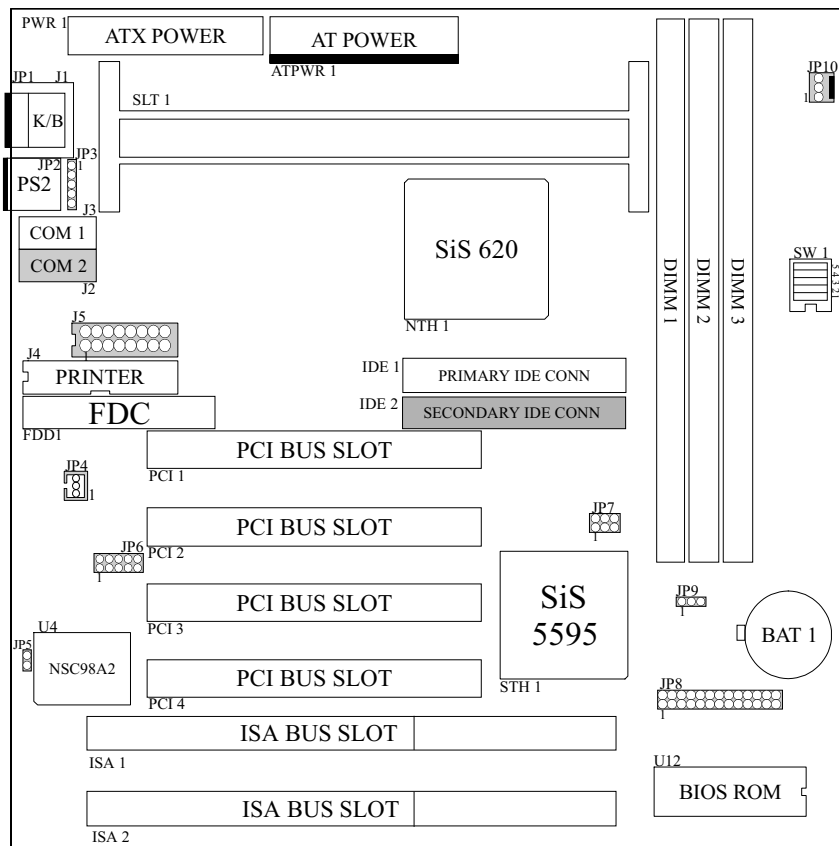

1.3 Motherboard Connectors

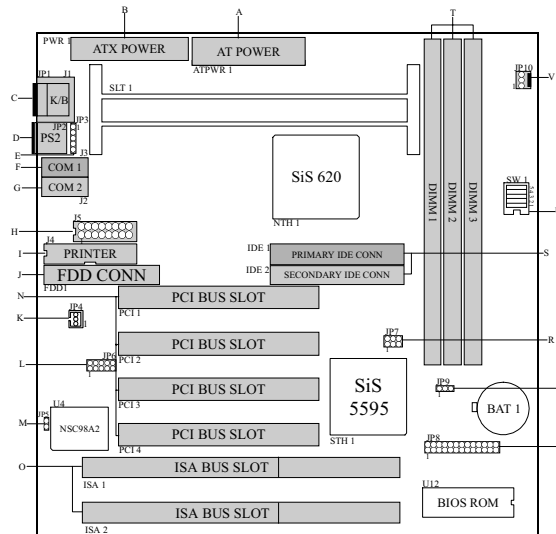

- | | |
|--|---|
| A. AT Power Connector (ATPWR1) | L. USB Connector (JP6) |
| B. ATX Power Connector (PWR1) | M. Ringin Wake Modem Card (JP5) |
| C. KeyBoard Connector (J1) | N. PCI Slots (PCI1-4) |
| D. PS/2 Mouse Connector (JP2) | O. ISA Slots (ISA1-2) |
| E. PS/2 Mouse Connector (JP3) | P. Front Panel Connectors (JP8) |
| F. COM 1 (J3) | Q. CMOS Function Selections(JP9) |
| G. COM 2 (J2) | R. SB Link (JP7) |
| H. VGA Connector (J5) | S. IDE Connectors (IDE1-2) |
| I. Parallel Port Connector (J4) | T. DIMMs (DIMM1-3) |
| J. Floppy Disk Connector (FDD1) | U. CPU Clock Selection (SW1) |
| K. Wake-On -LAN connector (JP4) | V. CPU FAN Connector (JP10) |

1.3.1 Front Panel Connectors (JP8)

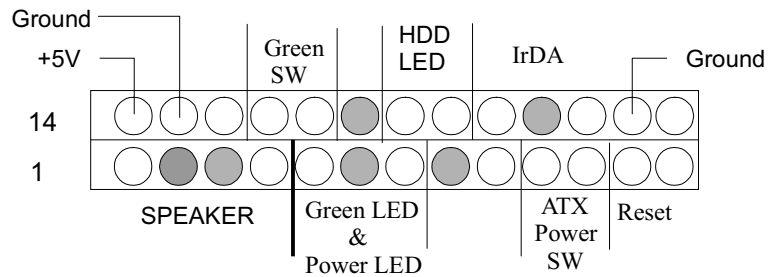

Pin No.	Assignment	Function	Pin No.	Assignment	Function
1	Speaker	Speaker Connector	14	+5V	VCC
2	NC		15	Ground	Ground
3	NC		16	Ground	NC
4	+5V		17	SMI	Green
5	Power LED(+)	Green LED & Power LED	18	Ground	Switch
6	NC		19	NC	NC
7	Ground		20	IDE LED	HDD LED
8	NC		21	+5V	
9	Ground	ATX Power SW	22	Ground	IrDA
10	Power SW		23	NC	
11	Ground	SW	24	IRR X 1	
12	Reset SW	Reset SW	25	Ground	
13	Ground	SW	26	IRTX	

1.3.2 Floppy Disk Connector (FDD)

The motherboard also provides a standard Floppy Disk Connector (FDC) that supports 360K, 720K, 1.2M, 1.44M, and 2.88M floppy disk types. This connector supports floppy drive ribbon cables.

1.3.3 Hard Disk Connectors (IDE 1 / 2)

The motherboard has a 32-bit Fast IDE Controller that provides PIO Mode 0~4, Bus Master, and Ultra DMA / 33/66 functionality. It has two HDD connectors IDE1 (primary) and IDE2 (secondary). You can connect up to four hard disk drives, a CD-ROM, a 120MB Floppy (reserved for future BIOS) and other devices to IDE1 and IDE2. These connectors support the IDE hard disk cable provided.

- IDE1 (Primary IDE Connector)

The first hard drive should always be connected to IDE1. IDE1 can connect a Master and a Slave drive. You must configure the second hard drive on IDE1 to Slave mode by setting the jumper accordingly.
- IDE2 (Secondary IDE Connector)

The IDE2 controller can also support a Master and a Slave drive. The configuration is similar to IDE1. The second drive on this controller must be set to slave mode.

1.3.4 ATX 20-pin Power Connector (PWR1)

This connector supports the onboard power button. Using the ATX power supply, functions such as Modem Ring Wake-Up and Soft Power-Off are supported by this motherboard. This power connector supports Instant Power-On functionality, which means that the system will boot up instantly when the power connector is inserted on the board.

PIN	SIGNAL	PIN	SIGNAL
1	3.3 V	11	3.3 V
2	3.3 V	12	-12 V
3	GND	13	GND
4	5 V	14	PS ON
5	GND	15	GND
6	5 V	16	GND
7	GND	17	GND
8	PW OK	18	-5 V
9	5V_SB	19	5 V
10	12 V	20	5 V

Warning:

Since the motherboard has the Instant Power-On function, make sure that all components are installed properly before inserting the power connector to ensure that no damage will be done.

1.4 Serial and Parallel Interface Ports

This system equipped with two serial ports and one parallel port. Both types of interface ports will be explained in this chapter.

The Serial Interface Port

The serial interface port is sometimes referred to as a RS-232 port or an asynchronous communications port. Printers, modems and other peripheral devices can be connected to a serial port. The serial port can also be used to connect your computer with another computer system. If you wish to transfer the contents of your hard disk to another system it can be accomplished by using each machine's serial port.

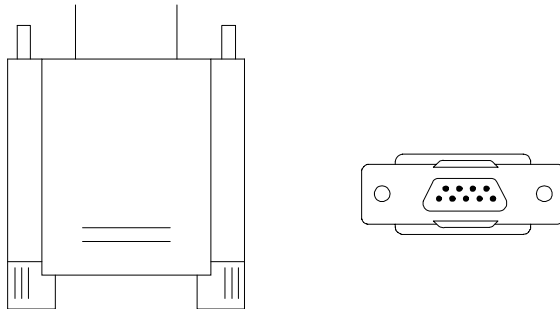

The serial ports on this system have two types of connectors, one 9-pin D-Sub and one 9-pin header. Some older computer systems and peripherals may only have a 25-pin connector. Should you need to connect your 9-pin serial port to a 25-pin serial port, you can purchase a 9-to-25 pin adapter.

Connectivity

The many ways that a serial port can be used make it necessary to be familiarized with the pinout diagram. The following chart gives you the function of each pin on the 9-pin connector. This information can be used when configuring certain software programs to work with the serial port.

Signal	Name	DB9 PIN
DCD	Data Carrier Detect	1
RX	Receive Data	2
TX	Transmit Data	3
DTR	Data Terminal Ready	4
GND	Signal Ground	5
DSR	Data Set Ready	6
RTS	Request to Send	7
CTS	Clear to Send	8
RI	Ring Indicator	9

Special Applications

There are two types of serial devices that can be connected to a serial port. One of the devices is called the “DTE” (Data Terminal Equipment) and the other device is called the “DCE” (Data Communications Equipment). If a modem is connected to a computer, for example, the modem is called the DCE and the computer is called the DTE. In situations such as this, the pins on the serial ports can be connected straight through.

In instances when there are two DTE devices connected together, such as a computer and a printer, a special adapter called a “Null Modem” is needed to make communication between the two devices possible.

When using the serial port to communicate between devices, one problem in particular may arise. Some manufacturers use one set of signals to begin communication with another device and other manufacturers do not use these signals to initiate communication. If you encounter a communication problem that cannot be resolved using a null modem, it can generally be assumed that one device is using the initialization signals and the other device is not. This can usually be resolved by wiring the RTS, CTS, and DCD pins together.

Serial Ports/COM Ports

The two serial ports on the computer are called COM1 and COM2, respectively. If you wish, two more serial ports can be added onto the computer using optional hardware. Should you choose to add the extra Serial ports (COM ports), they would be called COM3 and COM4.

When using serial ports to communicate with a peripheral devices, be sure to assign only one COM port number to each device. For example, if a printer and a scanner are both connected to your computer through serial ports the printer must be assigned one COM port (i.e. COM1) and the scanner must be assigned the other COM port (i.e. COM2). No two devices can be assigned to one COM port. Each peripheral must have its own COM port.

NOTE: Four serial ports may be installed on the computer. However, no more than two ports can be used simultaneously.

*If you have installed an internal modem, be careful not to assign a COM port number that has already been assigned to another device. This error is common.

When installing a device that is going to require the use of a serial port, use a diagnostic program to find out which ports are available. It may be necessary to remove expansion cards that have serial ports in order to check their jumper settings. The jumper settings will indicate which COM port the card has been assigned. Checking the expansion card will eliminate mistakes in overlapping COM ports. Once you have completed the installation of peripheral devices using the serial ports, be sure that the communication parameters such as baud rate, parity bit, etc. are matching. If your computer is set for a baud rate of 9600 and your modem is set for a baud rate of 2400, you will not be able to send messages. The manuals that accompany the peripheral devices will inform you on the procedure for setting their parameters. Software manuals will also have instructions on setting parameters.

1.4.1 Parallel Interface Port (LPT1)

Unlike the serial port, parallel interface ports have been standardized and should not present any difficulty interfacing peripherals to your system. Sometimes called a Centronics port, the parallel port is almost exclusively used with printers. The parallel port on your system has a 25-pin Header (see picture below). The pinouts for the parallel port are shown in the table below.

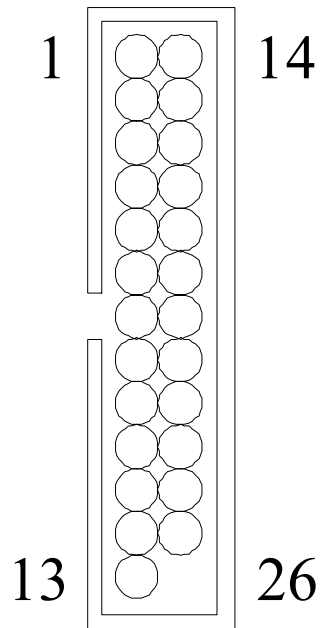

Signal	Pin
-Strobe	1
Data 0	2
Data 1	3
Data 2	4
Data 3	5
Data 4	6
Data 5	7
Data 6	8
Data 7	9
-Ack	10
Busy	11
Paper Empty	12
+Select	13
-Auto FDXT	14
-Error	15
-Init	16
-SLCTN	17
Ground	18
Ground	19
Ground	20
Ground	21
Ground	22
Ground	23
Ground	24
Ground	25

1.5 CPU Installation

1.5.1 CPU Installation Procedure

Motherboard

The M6SBC motherboard provides one Single Edge Contact (SEC) slot. This slot allows you to install a Pentium II & III CPU.

Before you use:

Please look on your motherboard and locate the CPU fan and CPU fan power supply. Please verify that this fan is directly used to cool the CPU and its heat sink, as well as to cool the motherboard and circulate the air.

WARNING : If air circulation is insufficient, the CPU will overheat, which may damage the CPU, CPU slot, and the motherboard.

Please inspect your motherboard to see if it has the Pentium II CPU retention kit components. (ATTENTION: The CPU installation component color and shape may vary slightly based on kits coming from different suppliers.)

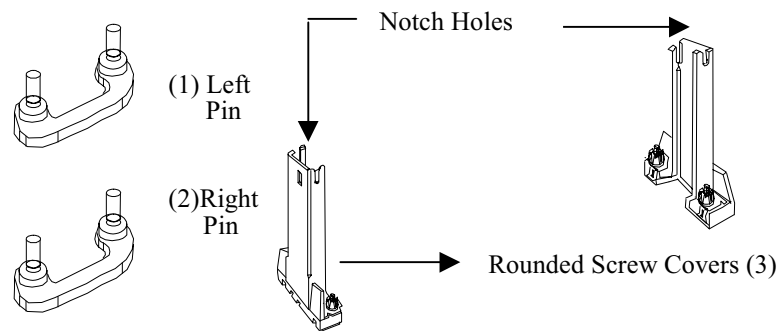

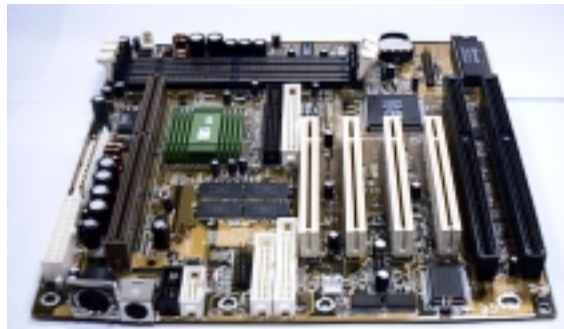
Pentium II Heat Sink Pins**Pentium II Heat Sink****M6SBC CPU Special Installation and Setup :****Install Pentium II / Pentium III / Celeron :****Installing the Heat Sink Support Frame :**

The Heat Sink Support Base can only be inserted one-way. Please match the leg sizes on the Heat Sink Support Base to the holes on the motherboard. Please insert the screws from the bottom of the motherboard and tighten into the rounded screw covers.

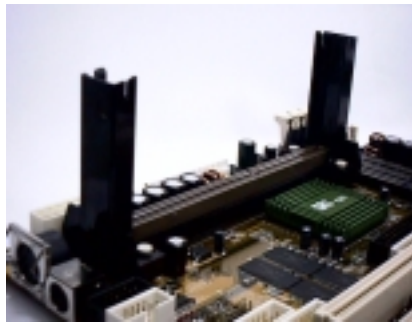

1 · Insert the CPU into the SEC Solt :

- (1) First, press the CPU unit into the Frame until it fits snugly into the notch holes. Then, clip the Heat Sink and CPU together with the Heat Sink Support Frame.
- (2) Firmly secure the Heat Sink by attaching the Heat Sink Frame TOP-Bar.

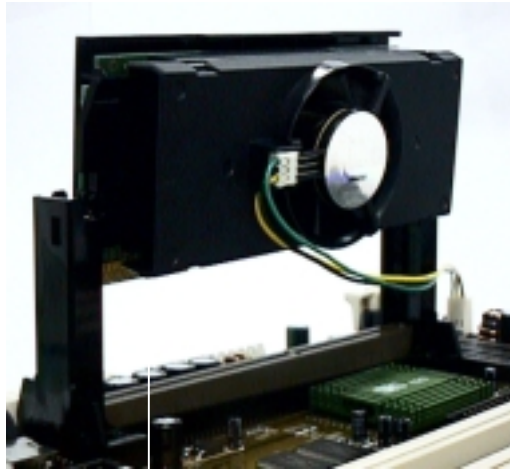

The correct direction to insert the Heat Sink and CPU into the Heat Sink Support Frame should allow you to easily insert

Please verify that the Heat Sink and CPU are tightly pressed together. Please check that the entire Frame, Heat Sink, and CPU unit are tightly installed and that there is no possible movement or looseness in the assembly.



1.5.2 CPU Clock Selection (SW1)

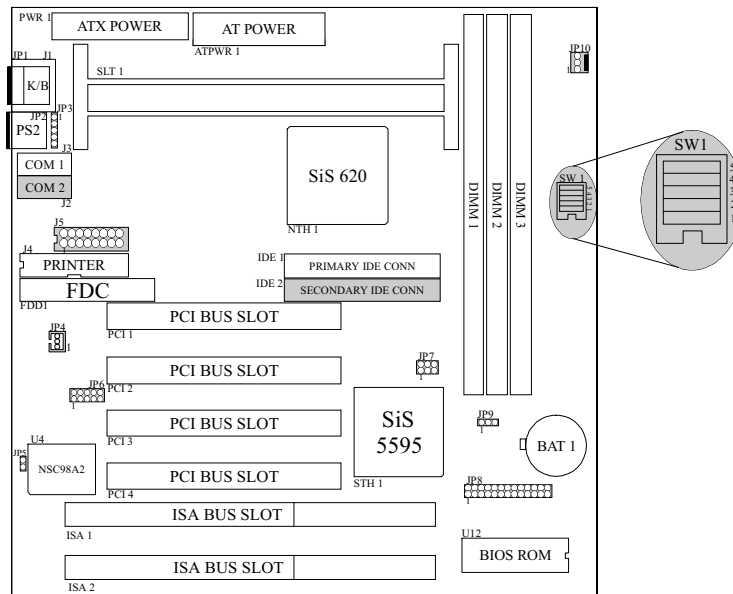

CPU Speed	RATIO	SW1(1)	SW1(2)	SW1(3)	SW1(4)	SW1(5)
233MHz	66 x3.5	ON	ON	ON	OFF	OFF
266MHz	66 x 4	ON	ON	OFF	ON	ON
300MHz	66 x4.5	ON	ON	OFF	OFF	ON
333MHz	66 x 5	ON	ON	OFF	ON	OFF
300MHz	100 x 3	OFF	ON	ON	ON	OFF
350MHz	100 x 3.5	OFF	ON	ON	OFF	OFF
400MHz	100 x 4	OFF	ON	OFF	ON	ON
450MHz	100 x 4.5	OFF	ON	OFF	OFF	ON
500MHz	100 x 5	OFF	ON	OFF	ON	OFF

1.6 Jumper Settings

A jumper is two or more pins which may be covered by a plastic jumper cap, allowing you to select different system options.

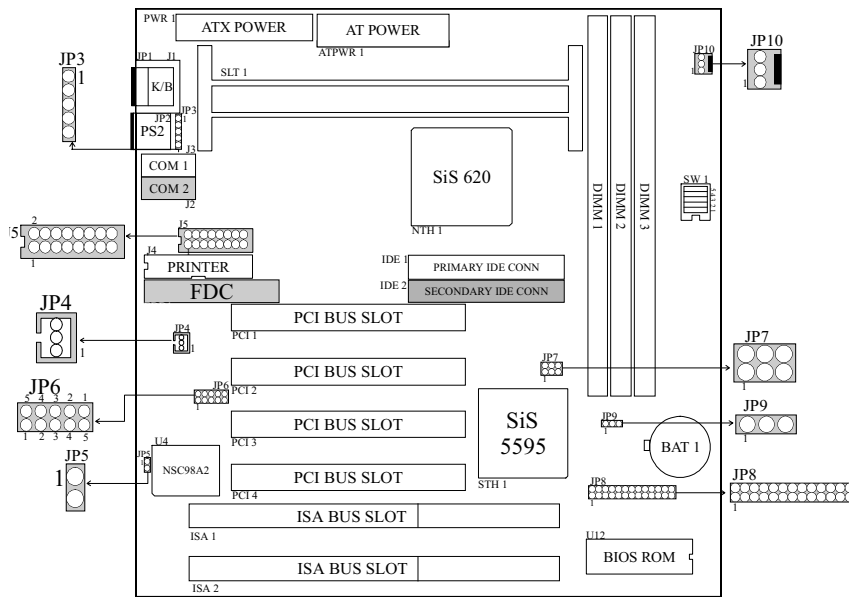

1.6.1 Wake-On-LAN Header (JP4)

Pin No.	Assignment
1	+5 V SBY
2	Ground
3	LAN-Wakeup



1.6.2 Internal Modem Ring (JP5)

Pin No.	Assignment
1	Ground
2	Ring-in Signal Input

1.6.3 Front USB Connectors (JP6)

Pin No.	Assignment
1	+5V
3	FNT_USBO-
5	FNT_USBO+
7	Ground
9	NC
2	NC
4	Ground
6	FNT_USB1+
8	FNT_USB1-
10	+5V

1.6.4 CMOS Function Selection (JP9)

JP9	Assignment
1  3 2-3 Closed	Normal Operation (default)
1  3 1-2 Closed	Clear CMOS Data (*Note)
1  3 Open	Onboard Battery Disabled

Note: 1. Please follow the procedure as below to clear CMOS Data.
 2. Please follow the procedure as below to clear BIOS Password if your password is lost or forgotten.

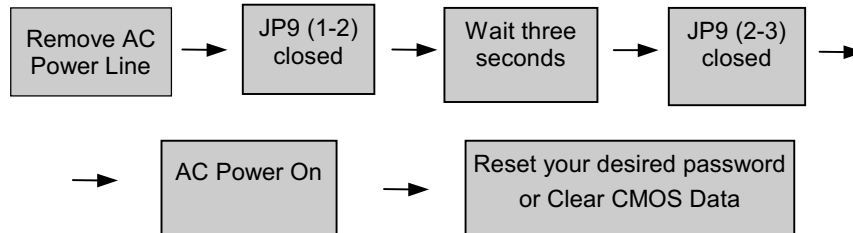

1.6.5 CPU Cooling Fan Power Connector (JP10)

Pin No.	Assignment
1	Control
2	+12V
3	Fan R.P.M Sense

1.7 DRAM Installation

1.7.1 DIMM

DRAM Access Time: 3.3V Unbuffered SDRAM PC100 Type required.

DRAM Type: 8MB/16MB/32MB/64MB/128MB DIMM Module(168pin)

Total Memory Size (MB)	Bank 0 DIMM1	Bank 1 DIMM2	Bank 2 DIMM3
8M	8M x 1 pc	----	----
16M	16M x 1 pc	----	----
32M	32M x 1 pc	----	----
64M	64M x 1 pc	----	----
128M	128M x 1 pc	----	----
16M	8M x 1 pc	8M x 1 pc	----
32M	16M x 1 pc	16M x 1 pc	----
64M	32M x 1 pc	32M x 1 pc	----
128M	64M x 1 pc	64M x 1 pc	----
24M	8M x 1 pc	8M x 1 pc	8M x 1 pc
40M	16M x 1 pc	16M x 1 pc	8M x 1 pc
72M	32M x 1 pc	32M x 1 pc	8M x 1 pc
136M	64M x 1 pc	64M x 1 pc	8M x 1 pc
32M	8M x 1 pc	8M x 1 pc	16M x 1 pc
48M	16M x 1 pc	16M x 1 pc	16M x 1 pc
80M	32M x 1 pc	32M x 1 pc	16M x 1 pc
144M	64M x 1 pc	64M x 1 pc	16M x 1 pc
48M	8M x 1 pc	8M x 1 pc	32M x 1 pc
64M	16M x 1 pc	16M x 1 pc	32M x 1 pc
96M	32M x 1 pc	32M x 1 pc	32M x 1 pc
160M	64M x 1 pc	64M x 1 pc	32M x 1 pc
80M	8M x 1 pc	8M x 1 pc	64M x 1 pc
96M	16M x 1 pc	16M x 1 pc	64M x 1 pc
128M	32M x 1 pc	32M x 1 pc	64M x 1 pc
192M	64M x 1 pc	64M x 1 pc	64M x 1 pc
384M	128M x 1 pc	128M x 1 pc	128M x 1 pc

*The list shown above for DRAM configuration is only for reference.

1.7.2 How to install a DIMM Module

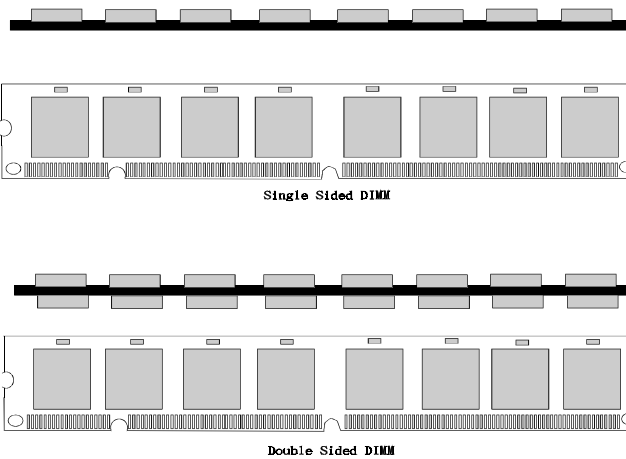

1. The DIMM socket has a “Plastic Safety Tab” and the DIMM memory module has an asymmetrical notch”, so the DIMM memory module can only fit into the slot in one direction.
2. Push the tabs out. Insert the DIMM memory modules into the socket at a 90-degree angle then push down vertically position so that it will fit into place.
3. The Mounting Holes and plastic tabs should fit over the edge and hold the DIMM memory modules in place.

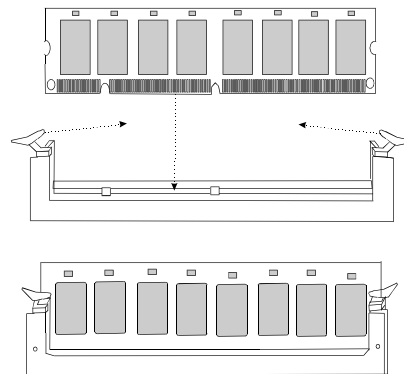

1.8 VGA Introduction

The 2D/3D Graphics and Video Accelerator support the function below:

- 3D Engine fetch texture data at up to 800MB/S
- AGP/PCI Configuration Space compliant.
- Dual 64-bit Data Bus Architecture up to 100MHz.
- Single Frame Buffer Architecture and YUV-TO-RGB Color Space Conversion.
- Supports DCI and Direct Draw drivers.
- Supports S/W MPEG-1 and MPEG-II Video playback.
- Display Memory support up to 8MB, 100MHz share memory.
- Programmable 32-Bit True-color 230MHz RAMDAC.
- Supports up to 1024x768 Graphic Mode and virtual screen up to 2048x2048 and 80x132-column Text Modes.

1.9 Super-AGP Architecture

- Dual 64-bit Data Path/Concurrent Transactions
 - Host-to-VGA (Frame buffer Memory Fill) Bandwidth up to 800MB/s
 - VGA-to-System Memory (Texture Memory Fetch) up to 800MB/s
- AGP/PCI Configuration Space Compliant
- Built-in Virtual PCI-to-PCI Bridge.
- 8-Way/16-Entry GART Cache
- PCI-to-AGP Memory Writes.

1.10 2D/3D Graphics Accelerator

2D Graphics Accelerator

- DirectDraw
 - All 256 Raster OP
 - Color/Font Expansion
 - Pattern Fills, Clipping
 - 64x64x2 HW Cursor
 - Transparent BitBlt
 - 8MB Frame Buffer w/Linear Addressing
- Capable of 3D 1024x768x32bpp w/Z buffer Support

3D Graphics Accelerator

- Pass 38/41 3D WB98 Quality Tests
- GART/Texture Cache
- Flat/Gouround Shading
- Fogging, Alpha Blending
- Specular Lighting
- Perspective Correction
- 16-bit Z Buffer
- Tri-Linear Texture Filtering
- Dithering
- MipMap W/10 LOD

1.11 Display Memory

UMA Mode

- 2M/4M/8M System Memory Sharable as Frame Buffer
- MCLK = System Memory Clock (SDRAM Clock)

1.12 Resolution

- 230MHz RAMDAC
- 640x480 8/16/32 Bpp Colors @ 85Hz NI
- 800x600 8/16/32 Bpp Colors @ 85Hz NI
- 1024x768 8/16/32 Bpp Colors @ 85Hz NI
- 1280x1024 8/16 Bpp Colors @ 85Hz NI
- 1600x1200 8 Bpp Colors @ 85Hz NI

1.13 Video Accelerator

- YUV-to-RGB Color Space Conversion
- Bi-Linear Video Interpolation
- 0Graphic/Video Overlay Function
- 64x16 Video Capture FIFO
- Two 96x64 Video Playback Line Buffers
- Support DirectDraw Driver

2. BIOS Setup

Entering Setup

The way to enter Setup is to power on the Computer, and when the message below appears briefly at the bottom of the screen during the POST (Power On Self Test), press the <F2> key.

Main Menu

The on line description of the highlighted setup function is displayed at the bottom of the screen.

Status Page Setup Menu/Option Page Setup Menu

Press <F1> to pop up a small help window that describes the appropriate keys to use and the possible selections for the highlighted item. To exit the Help Window Press <Esc>.

Control Keys

Up arrow	Move to previous item
Down arrow	Move to next item
Left arrow	Move to the item at left
Right arrow	Move to the item at right
Esc key	Main Menu:make a space Quit and do not save changes into CMOS Status Page Setup Menu and Option Page Setup Menu: Exit current page and return to Main Menu
PgUp key	Increase the numeric value or make changes
PgDn key	Decrease the numeric value or make changes
+ key	Increase the numeric value or make changes
- key	Decrease the numeric value or make changes
F1 key	General help, only for Status Page Setup Menu and Option Page Setup Menu
(Shift) F2 key	Change color to one of 16 colors. F2 to select color forward, (Shift) F2 to select color backward
F3 key	Reserved
F4 key	Reserved
F5 key	Restore the previous CMOS value, only for Option Page Setup Menu
F6 key	Load the default CMOS value from BIOS default table, only for Option Page Setup Menu
F7 key	Load the default
F8 key	Reserved
F9 key	Reserved
F10 key	Save all the CMOS changes, only for Main Menu

2.1 Main Menu

Once you enter AWARD BIOS CMOS Setup Utility, the Main Menu (**Figure 1**) will appear on the screen. The Main Menu allows you to select an item and press <Enter> to accept or enter its sub-menu.

■ Figure 1. Main Menu

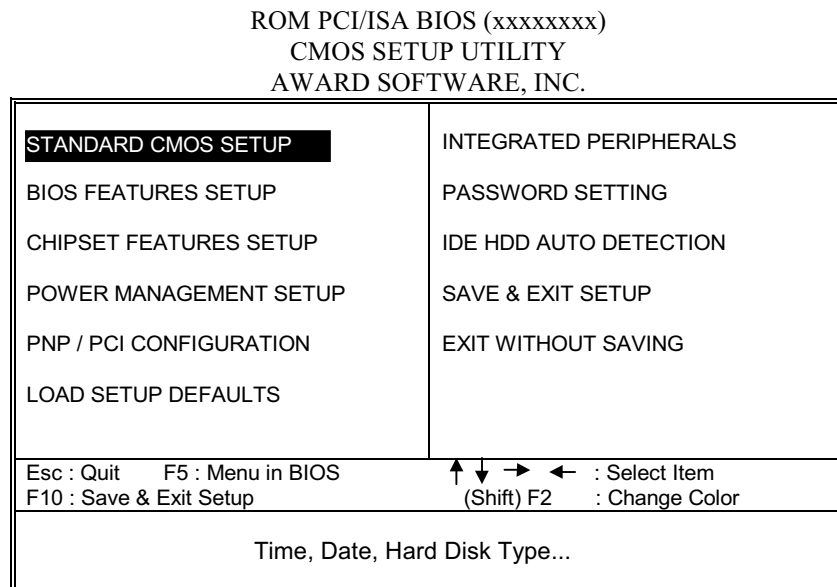

Standard CMOS Setup

This setup page includes all the items in a standard compatible BIOS.

BIOS Features Setup

This setup page includes all the items for the BIOS special enhanced features.

Chipset Features Setup

This setup page includes all the items for chipset special features.

Power Management Setup

This setup page includes all the items for power management features.

PnP / PCI Configuration

This category specifies the value (in units of PCI bus clocks) of the latency timer for this PCI bus master and the IRQ level for PCI device.

Load Setup Defaults

Chipset defaults indicates the values required by the system for maximum performance. The OEM manufacturer may change to defaults through MODBIN before the binary image burn into the ROM.

Integrated Peripherals

This setup page includes all the items for Integrated Peripherals features.

Supervisor Password / User Password Setting

Change, set, or disable password. It allows you to limit access to the system and Setup, or just to Setup.

IDE HDD Auto Detection

Automatically configure hard disk parameters.

Save & Exit Setup

Save CMOS value changes to CMOS and exit setup.

Exit Without Saving

Abandon all CMOS value changes and exit setup.

2.2 Standard CMOS Setup

The items in the Standard CMOS Setup Menu are divided into categories. Each category includes no, one, or more than one setup item. Use the arrow keys to highlight the item and then use the <PgUp> or <PgDn> keys to select the value you want in each item.

■ Figure 2. Standard CMOS Setup Menu

ROM PCI/ISA BIOS (xxxxxxx)
STANDARD CMOS SETUP
AWARD SOFTWARE, INC.

Date (mm:dd:yy) : Tue, Jan 5 1999								
Time (hh:mm:ss) : 11 : 37 : 30								
HARD DISKS	TYPE	SIZE	CYLS	HEAD	PRECOMP	LANDS	SECTOR	MODE
Primary Master	: Auto	0	0	0	0	0	0	Auto
Primary Slave	: Auto	0	0	0	0	0	0	Auto
Secondary Master	: Auto	0	0	0	0	0	0	Auto
Secondary Slave	: Auto	0	0	0	0	0	0	Auto
Drive A	:1.44MB, 3.5 in.							
Drive B	:None							
Video	:EGA/VGA							
Halt On	:All, But Keyboard							
Base Memory						:	0K	
Extended Memory						:	0K	
Other Memory						:	512K	
Total Memory						:	512K	
Esc : Quit			↑ ↓ → ← : Select Item			PU/PD/+/-:Modify		
F1 : Help			(Shift) F2 : Change Color					

Date

The Date format is **<day><month><date><year>**.

Day	The day, from Sun to Sat, is determined by the BIOS and is display-only
Date	The date, from 1 to 31 (or the maximum allowed in the month)
month	The month, Jan through Dec
year	The year, from 1994 through 2079

Time

The time format is **<hour><minute><second>**. The time is calculated based on the 24-hour military-time clock. For example, 2 p.m. is 14:00:00.

Hard Disk Type

This categories identifies the types of hard disk(s) that have been installed in the computer. There are 46 predefined types and a user definable type. Type 1 to Type 45 are predefined. Type "User" is user-definable. Type "Auto" is automatically defined by BIOS.

Press **<PgUp>** or **<PgDn>** to select a numbered hard disk type or type the number and press **<Enter>**. Note that the specifications of your drive must match with the drive table. The hard disk will not work properly if you enter improper information for this category. If your hard disk drive type is not listed, you can use Type "User" to define your own drive type manually.

If you select type "User", related information is asked to be entered for several items. Enter the information directly from the keyboard and press **<Enter>**. This information should be provided in the documentation from your hard disk vendor or the system manufacturer. Most new drives will also have the parameters given on the label on top of the drive.

CYLN	number of cylinders
HEAD	number of heads
WPCOM	write precompensation
SEC	number of sectors
LBA MODE	type of LBA mode
BLK MODE	type of Block mode
PIO MODE	type of PIO
32BIT MODE	type of 32-Bit transfer mode

If a hard disk has not been installed select "NOT Installed" and press <Enter>.

Drive A Type/Drive B Type

The category identifies the types of floppy disk drive A / drive B that have been installed in the computer.

None	No floppy drive installed
360K, 5 1/4	5-1/4 inch PC-type standard drive; 360 kilobyte capacity
1.2M, 5 1/4	5-1/4 inch AT-type high-density drive; 1.2 megabyte capacity
720K, 3 1/2	3-1/2 inch double-sided drive; 720 kilobyte capacity
1.44M, 3 1/2	3-1/2 inch double-sided drive; 1.44 megabyte capacity
2.88M, 3 1/2	3-1/2 inch double-sided drive; 2.88 megabyte capacity

Video

This category selects the type of adapter used for the primary system monitor, and must match your video display card and monitor. Although secondary monitors are supported, you do not have to select the type in Setup.

EGA/VGA	Enhanced Graphics Adapter/Video Graphics Array. For EGA, VGA, SEGA, or PGA monitor adapters.
CGA 40	Color Graphics Adapter, power up in 40 column mode
CGA 80	Color Graphics Adapter, power up in 80 column mode
MONO	Monochrome adapter, includes high resolution monochrome adapters

Halt On

The category determines whether the computer will stop if an error is detected during power up.

No errors	Whenever the BIOS detects a non-fatal error the system will be stopped and you will be prompted.
All errors	The system boot will not stop for any error that may be detected.
All, But Keyboard	The system boot will not stop for a keyboard error, it will stop for all other errors.
All, But Diskette	The system boot will not stop for a disk error, it will stop for all other errors.
All, But Disk/Key	The system boot will not stop for a keyboard or disk error, it will stop for all other errors.

Memory

This category is display-only which is determined by the POST (Power On Self Test) of the BIOS.

Base Memory

The POST of the BIOS will determine the amount of base (or conventional) memory installed in the system. The value of the base memory is typically 512K for system with 512K memory installed on the motherboard, or 640K for system with 640K or more memory installed on the motherboard.

Extended Memory

The BIOS determines how much extended memory is present during the POST. This is the amount of memory located above 1MB in the CPU's memory address map.

Other Memory

This refers to the memory located in the 640K address space. This is the memory that can be used for different applications. DOS uses this area to load device drivers to keep as much base memory free for application programs. The most common use for this area is Shadow RAM.

2.3 BIOS Features Setup

!! WARNING !! The information about BIOS defaults in the manual (**Figure 3.4.5.6.8**) is just for reference, please refer to the BIOS installed on board, for update information.

■ **Figure 3. BIOS Features Setup Menu**

ROM PCI/ISA BIOS (xxxxxxxx)
 BIOS FEATURES SETUP
 AWARD SOFTWARE, INC.

Virus Warning	: Disabled	Video BIOS Shadow	: Enabled
CPU Internal Cache	: Enabled	C8000-CBFFF Shadow	: Disabled
External Cache	: Enabled	CC000-CFFFF Shadow	: Disabled
CPU L2 Cache ECC Checking	: Disabled	D0000-D3FFF Shadow	: Disabled
Quick Power On Self Test	: Enabled	D4000-D7FFF Shadow	: Disabled
Boot From LAN First	: Disabled	D8000-DBFFF Shadow	: Disabled
Boot Sequence	: A,C,SCSI	DC000-DFFFF Shadow	: Disabled
Swap Floppy Drive	: Disabled		
Boot Up Floppy Seek	: Enabled		
Boot Up NumLock Status	: Off		
Typematic Rate Setting	: Disabled		
Typematic Rate (Chars/Sec)	: 6		
Typematic Delay (Msec)	: 250		
Security Option	: Setup		
PCI/VGA Palette Snoop	: Disabled		
OS Select For DRAM > 64MB	: Non-OS2	ESC: Quit	↑ → ↓ ← : Select Item
Report No FDD For WIN 95	: No	F1 : Help	PU/PD/+/- : Modify
		F5 : Old Values	<Shift> F2 : Color
		F7 : Load Setup Defaults	

Virus Warning

This category flashes on the screen. During and after the system boot up, any attempt to write to the boot sector or partition table of the hard disk drive will halt the system and an error message will appear. In the mean time, you can run an anti-virus program to locate the problem.

Disabled (default)	No warning message to appear when anything attempts to access the boot sector or hard disk partition table.
Enabled	Activates automatically when the system boots up causing a warning message to appear when anything attempts to access the boot sector of hard disk partition table.

CPU Internal Cache

The default value is Enabled.

Enabled (default)	Enable cache
Disabled	Disable cache

External Cache

Cache memory is additional memory that is much faster than conventional DRAM (system memory). Most, but not all, modern PCs have additional (external) cache memory. When the CPU requests data, the system transfers the requested data from the main DRAM into cache memory, for even faster access by the CPU.

Enabled (default)	Enable cache
Disabled	Disable cache

CPU L2 Cache ECC Checking

Choose Enabled or Disabled. This option enables the level 2 cache memory ECC (error check correction). Using 66MHz CPU BUS Deschute processor, set to Enabled or Disabled. 100MHz CPU BUS Deschute processor, always set to Enabled. Klamath processor always set to Disabled.

Quick Power On Self Test

This option enables the level 2 external cache memory.

Enabled (default)	Enable is quick POST
Disabled	Normal is POST

Boot from LAN First

During Enabled, If there's a LAN card onboard the priority from booting will be from the LAN.

Boot Sequence

This option determines which drive the computer searches the OS at boot-up. The settings are "A, C, SCSI", "C, A, SCSI", "C, CDROM, A", "CDROM, C, A", "D, A, SCSI", "E, A, SCSI", "F, A, SCSI", "SCSI, A, C", "SCSI, C, A", "C only" or "LS/ZIP, C", etc. **The default is "A, C, SCSI".**

Swap Floppy Drive

Switches the floppy disk drive between being designated as A and B.

Default is Disabled.

Boot Up Floppy Seek

During POST, BIOS will determine if the floppy disk drive installed is 40 or 80 tracks. 360K type is 40 tracks while 720K, 1.2M, and 1.44M are all 80 tracks.

Enabled (default)

BIOS searches for the floppy disk drive to determine if it is 40 or 80 tracks. Note that BIOS cannot tell from 720K, 1.2M or 1.44M drive type as they are all 80 tracks.

Disabled

BIOS will not search for the type of floppy disk drive by track number. Note that there will not be any warning message if the drive installed is 360K.

Boot Up NumLock Status

The default value is On.

On

Numpad is number keys.

Off (default)

Numpad is arrow keys.

Typematic Rate Setting

This determines the typematic rate.

Enabled	Enable typematic rate and typematic delay programming.
Disabled (default)	Disable typematic rate and typematic delay programming. The system BIOS will use default value of these 2 items and the default is controlled by keyboard.

Typematic Rate (Chars/Sec)

6 (default)	6 characters per second
8	8 characters per second
10	10 characters per second
12	12 characters per second
15	15 characters per second
20	20 characters per second
24	24 characters per second
30	30 characters per second

Typematic Delay (Msec)

Choose the length of delay from the time you press a key and the character repeating. (units are mil-sec)

Security Option

This category allows you to limit access to the system and Setup, or just to Setup.

System	The system will not boot and access to Setup will be denied if the correct password is not entered at the prompt.
Setup (default)	The system will boot, but access to Setup will be denied if the correct password is not entered at the prompt.

PCI/VGA Palette Snoop

Choose Disabled or Enabled. Some graphic controllers which are not VGA compatible take the output from a VGA controller and map it to their display as a way to provide boot information and VGA compatibility.

However, the color information coming from the VGA controller is drawn from

the palette table inside the VGA controller to generate the proper colors, and the graphic controller needs to know what is in the palette of the VGA controller. To do this, the non-VGA graphic controller watches for the Write access to the VGA palette and registers the snoop data. In PCI based systems, where the VGA controller is on the PCI bus and a non-VGA graphic controller is on an ISA bus, the Write Access to the palette will not show up on the ISA bus if the PCI VGA controller responds to the Write.

In this case, the PCI VGA controller should not respond to the Write, it should only snoop the data and permit the access to be forwarded to the ISA bus. The non-VGA ISA graphic controller can then snoop the data on the ISA bus. Unless you have the above situation, you should disable this option.

Disabled (default)	Disables the function.
Enabled	Enables the function.

OS Selection for DRAM > 64MB

Allows OS/2 to be used with > 64MB of DRAM. Settings are Non-OS/2 (default) and OS/2. Set to OS/2 if using more than 64MB and running OS/2.

DEFAULT is Non-OS2.

Report No FDD for Win 95

This function is only use when you are testing SCT for Windows 95 Logo.

Video BIOS Shadow

Determines whether video BIOS will be copied to RAM for faster execution.

Enabled (default)	Optional ROM is enabled.
Disabled	Optional ROM is disabled.

C8000 - CFFFF Shadow / D8000 - DFFFF Shadow

Determines whether the optional ROM will be copied to RAM for faster execution.

Enabled	Optional ROM is shadowed.
Disabled (default)	Optional ROM is not shadowed.

Note: For C8000 - DFFFF option - ROM on PCI BIOS, BIOS will automatically enable the shadow RAM. User does not have to select the item.

2.4 Chipset Features Setup

The Chipset Features Setup option is used to change the values of the chipset registers. These registers control most of the system options in the computer.

■ Figure 4. Chipset Feature Setup Menu

ROM PCI/ISA BIOS (xxxxxxxx)
CHIPSET FEATURES SETUP
AWARD SOFTWARE, INC.

RAS Pulse Width Refresh : 6T	Current CAPUFAN1 Speed :
RAS to CAS Delay : 4T	+ 5 (V) :
SDRAM CAS Latency : 3T	3.3 (V) :
Memory Hole at 15M-16M : Disabled	2.5 (V) :
AGP Aperture Size : 64MB	Vcore :
Concurrent function(MEM) : Disabled	
	ESC : Quit ↑ ↓ → ← : Select Item
	F1 : Help PU/PD/+/- : Modify
	F5 : Old Values <Shift> F2 : Color
	F7 : Load Setup Defaults

RAS Pulse Width Refresh

This set the memory Refresh signal width.

RAS to CAS Delay

This set the time delay between Row Address Strobe and Column Address Strobe.
The unit of measurement is a CPU cycle.

2T	Two clocks
3T	Three clocks
4T (default)	Four clocks

SDRAM CAS Latency

This option determines the CAS latency time parameter of SDRAM. The settings are 2 or 3 clocks.

2T
3T (default)

Memory Hole at 15M-16M

You can reserve this area of system memory for ISA adapter ROM. When this area is reserved, it cannot be cached. The user information of peripherals that need to use this area of system memory usually discusses their memory requirements.

Disabled (default)

AGP Aperture Size

Select the size of the Accelerated Graphics Port (AGP) aperture. The aperture is a portion of the PCI memory address range dedicated for graphics memory address space. Host cycles that hit the aperture range are forwarded to the AGP without any translation.

Concurrent function (MEM)

This enable concurrent memory function.

Disabled (default)

Current CPUFAN1 Speed

This field displays the current speed of CPU fan, if your computer contains a monitoring system.

5 (V) / 3.3 (V) / 2.5 (V) / Vcore

The following system voltages are monitoring.

5 (V):
3.3 (V):
2.5 (V):
Vcore :

2.5 Power Management Setup

■ **Figure 5. Power Management Setup Menu**

ROM PCI/ISA BIOS (xxxxxxx)
POWER MANAGEMENT SETUP
AWARD SOFTWARE, INC.

Power Mangement	: User Define	IRQ [3-7 , 9-15] , NMI	: Enabled
PM Control by APM	: Yes	IRQ 8 Break suspend	: Disabled
Video Off Option	: Susp Stby ->Off	*Power Button Over Ride	: Instant Off
Video Off Method	: DPMS Supported	*Ring Power Up Control	: Disabled
Switch Function	: Break / Wake	*Power on by PCI Card	: Disabled
Doze Speed (div by)	: 2/8	*LAN Power Up Control	: Disabled
Stdby Speed (div by)	: 1/8	*Power Up by Alarm	: Disabled
MODEM Use IRQ	: 3		
** PM Timers **			
HDD Off After	: Disabled		
Doze Mode	: Disabled		
Standby Mode	: Disabled		
Suspend Mode	: Disabled		
** PM Events **			
HDD Ports Activity	: Enabled	ESC : Quit	↑ ↓ → ← : Select Item
COM Ports Activity	: Enabled	F1 : Help	PU/PD/+/- : Modify
LPT Ports Activity	: Enabled	F5 : Old Values	<Shift> F2 : Color
VGA Activity	: Enabled	F7 : Load Setup Defaults	

Power Management

User Define
(Max. Saving)

Users can configure their own power management.

Min Saving

Pre-defined timer values are used such that all timers are at their MAX value.

Max Saving

Pre-defined timer values are used such that all timers are at their MIN value.

PM Control by APM

- No** System BIOS will ignore APM when Power Management is on.
- Yes (default)** System BIOS will wait for APM's prompt before it enters any PM mode.

Video Off Option

This choose the according way of Video off .

Susp, Stby -> Off (default)

Video Off Method

- Blank Screen** The system BIOS will only blank the screen when disabling video.
- V/HSYNC+Blank** In addition to the above, BIOS will also turn off the V-SYNC & H-SYNC signals from VGA card to monitor.
- DPMS Supported (default)** This function is enabled only for a VGA supporting DPMS.

Switch Function

You can choose whether or not to permit your system to enter complete Suspend mode. Suspend mode offers greater power savings, with a correspondingly longer awakening period.

Break/Wake (default)

Disabled

Doze Speed (div by)

This set CPU clock ratio in Doze mode.

2/8 (default)

Stdby Speed (div by)

This set CPU clock ratio in Stdby mode.

1/8 (default)

MODEM Use IRQ

Set the interrupt request (IRQ) line assigned to the modem (if any) on your system. Activity of the selected IRQ always awakens the system.

3 (default)

HDD Off After

By default, this item is Disabled, meaning that no matter the mode the rest of the system, the hard drive will remain ready. Otherwise, you have a range of choices from 1 to 15 minutes or Suspend. This means that you can elect to have your hard disk drive be turned off after a selected number of minutes or when the rest of the system goes into a suspend mode.

Disabled (default)

Doze Mode

This option specifies how long the CPU is continuously idle before entering the doze mode. When the system is in Doze mode, the screen will be blank.

Standby Mode

After selected period of system inactivity, the fixed disk drive and video shut-off while all other devices still operate at full speed.

Disabled (default)

Suspend Mode

This options allows the user to indicate how long the system will be idle before entering the suspend mode, which turns off the CPU and saves the energy of the system

HDD Ports Activity

When set to Enabled (default), any event occurring at a HDD (serial) port will awaken a system which has been powered down.

Enabled (default)

COM Ports Activity

When enabled, any COM Ports activity restarts the global timer for Standby mode.

Enabled (default)

LPT Ports Activity

When enabled, any LPT Ports activity restarts the global timer for Standby mode

Enabled (default)

VGA Active

When enabled, any video activity restarts the global timer for Standby mode.

Enabled (default)

IRQ [3-7, 9-15], NMI

The default value is "Legacy ISA" OR "PCI/ISA PnP".

Enabled (default)

IRQ 8 Break Suspend

You can turn On or Off monitoring of IRQ 8 (the Real Time Clock) so it does not awaken the system from Suspend mode.

Disabled (default)

Power Button Over Ride

This item allows you to set the 'off-function' of the power button by software control. The default : Delay 4 Sec. Instant Off.

Instant Off (default)

Ring Power Up Control

This enable Ring-in can wake up the system from power down.

Disabled (default)

Power on by PCI Card

This enabled PCI card can wake up the system from power down.

Disabled (default)

LAN Power Up Control

This enabled LAN card can wake up the system from power down.

Disabled (default)

Power Up by Alarm

When set to Enabled RTA Alarm Resume, you can set the date (of month) and time (hh:mm:ss), to any date occurring, at which a system that has been powered down will awaken.

Disabled (default)

2.6 PNP / PCI Configuration Setup

■ Figure 6. PNP / PCI Configuration Setup Menu

ROM PCI/ISA BIOS (xxxxxxx)
 PNP / PCI FUNCTION SETUP
 AWARD SOFTWARE, INC.

PNP OS Installed : No	Assign IRQ for VGA : Enabled
Resources Controlled By : Manual	Assign IRQ for USB : Enabled
Reset Configuration Data : Disabled	
IRQ-3 assigned to : PCI/ISA PnP	
IRQ-4 assigned to : PCI/ISA PnP	
IRQ-5 assigned to : PCI/ISA PnP	
IRQ-7 assigned to : PCI/ISA PnP	
IRQ-9 assigned to : PCI/ISA PnP	
IRQ-10 assigned to : PCI/ISA PnP	
IRQ-11 assigned to : PCI/ISA PnP	
IRQ-12 assigned to : PCI/ISA PnP	
IRQ-14 assigned to : Legacy ISA	
IRQ-15 assigned to : Legacy ISA	
DMA-0 assigned to : PCI/ISA PnP	
DMA-1 assigned to : PCI/ISA PnP	ESC : Quit ↑↓→← : Select Item
DMA-3 assigned to : PCI/ISA PnP	F1 : Help PU/PD/+/- : Modify
DMA-5 assigned to : PCI/ISA PnP	F5 : Old Values <Shift> F2 : Color
DMA-6 assigned to : PCI/ISA PnP	F7 : Load Setup Defaults
DMA-7 assigned to : PCI/ISA PnP	

PnP OS Installed

When set to YES, BIOS will only initialize the PnP cards used for booting (VGA, IDE, SCSI). The rest of the cards will be initialized by the PnP operating system like WindowsTM95. When set to NO, BIOS will initialize all the PnP cards. Therefore for non-PnP operating system (DOS, NetwareTM), this option must be set to "NO".

Resources Controlled By “Auto” or “Manual”

By Choosing “Auto” the system BIOS will detect the system resource and automatically assign the relative IRQ and DMA channel for each peripheral.

By Choosing “Manual”(default), the user will need to assign IRQ & DMA for add-on cards. Be sure that there are no IRQ/DMA and I/O ports conflict.

Reset Configuration Data

The system BIOS supports the PnP feature so the system needs to record which resource is assigned and protect resources from conflict. Every peripheral device has a node which is called ESCD. This node records which resources are assigned to it. The system needs to record and update ESCD to the memory locations. These locations (4K) are reserved at the system BIOS.

If Disabled (default) is chosen, the system’s ESCD will update only when the new configuration varies from the last one.

If Enabled is chosen, the system is forced to update ESCDs and then is automatically set to the “Disabled” mode.

IRQ-3	assigned to : PCI / ISA PnP
IRQ-4	assigned to : PCI / ISA PnP
IRQ-5	assigned to : PCI / ISA PnP
IRQ-7	assigned to : PCI / ISA PnP
IRQ-9	assigned to : PCI / ISA PnP
IRQ-10	assigned to : PCI / ISA PnP
IRQ-11	assigned to : PCI / ISA PnP
IRQ-12	assigned to : PCI / ISA PnP
IRQ-14	assigned to : PCI / ISA PnP
IRQ-15	assigned to : PCI / ISA PnP
DMA-0	assigned to : PCI / ISA PnP
DMA-1	assigned to : PCI / ISA PnP
DMA-3	assigned to : PCI / ISA PnP
DMA-5	assigned to : PCI / ISA PnP
DMA-6	assigned to : PCI / ISA PnP
DMA-7	assigned to : PCI / ISA PnP

The above settings will be shown on the screen only if “Manual” is chosen for the Resources Controlled By function.

Legacy is the term which signifies that a resource is assigned to the ISA Bus and provides for non PnP ISA add-on cards. PCI / ISA PnP signifies that a resource is assigned to the PCI Bus or provides for ISA PnP add-on cards and peripherals.

Assign IRQ For VGA

Lets the user choose which IRQ to assign for VGA card.

Assign IRQ For USB

Set to Enabled when USB port will be used. Set to Disable if the USB port will not be used.

Enabled (default)	Assign a specific IRQ for USB.
Disabled	No IRQ is assigned for USB.

2.7 Load Setup Defaults

Chipset defaults indicate the values required by the system for maximum performance.

■ Figure 7. Load Setup Defaults Screen

ROM PCI/ISA BIOS (xxxxxxx)
CMOS SETUP UTILITY
AWARD SOFTWARE, INC.

STANDARD CMOS SETUP	INTEGRATED PERIPHERALS
BIOS FEATURES SETUP	PASSWORD SETTING
CHIPSET FEATURES SETUP	IDE HDD AUTO DETECTION
POWER MANAGE	LOAD SETUP Defaults (Y/N) ? N
PCI & PCI CONFIC	SAVING
LOAD SETUP DEF	
Esc : Quit F5 : Menu in BIOS ↑ ↓ → ← : Select Item	
F10 : Save & Exit Setup (Shift) F2 : Change Color	
Load SETUP Defaults except Standard CMOS SETUP	

If you wish to load the SETUP Defaults, change the prompt to <Y> and press <ENTER>.

2.8 Integrated Peripherals Setup

■ Figure 8. Integrated Peripherals Setup Menu

ROM PCI/ISA BIOS (xxxxxxxx)
 INTEGRATED PERIPHERALS
 AWARD SOFTWARE, INC.

Internal PCI/IDE	: Both	Onboard parallel Port	: 378/IRQ7
IDE Primary Maste PIO	: Auto	Parallel Port Mode	: SPP
IIDE Primary Slave PIO	: Auto	PS/2 mouse function	: Enabled
IDE Secondary Master PIO	: Auto	USB Controller	: Enabled
IDE Secondary Slave PIO	: Auto	USB Keyboard Support	: Disabled
Primary Master Ultra DMA	: Auto	Init Display First	: PCI Slot
Primary Slave Ultra DMA	: Auto	VGA Shared Memory Size	: 4MB
Secondary Master Ultra DMA	: Auto	VGA Memory Clock (MHz)	: 66
Secondary Slave Ultra DMA	: Auto		
IDE Burst Mode	: Enabled		
IDE HDD Block Mode	: Enabled		
		ESC : Quit	↑ → ↓ ← : Select Item
Onboard FDC Controller	: Enabled	F1 : Help	PU/PD/+/- : Modify
Onboard Serial Port 1	: 3F8/IRQ4	F5 : Old Values	<Shift> F2 : Color
Onboard Serial Port 2	: 2F8/IRQ3	F7 : Load Setup Defaults	
UR2 Mode	: Standard		

Internal PCI/IDE

This choose Internal PCI/IDE
Both (default)

IDE Primary / Secondary Master / Slave PIO

The IDE PIO (Programmed Input / Output) fields let you set a PIO mode (0-4) for each of the IDE devices that the onboard IDE interface supports. Modes 0 through 4 provide successively increased performance. In Auto mode, the system automatically determines the best mode for each device.

Auto (default)

IDE Primary / Secondary Master / Slave UDMA

Ultra DMA /33 implementation is possible only if your IDE hard drive supports it and the operating environment includes a DMA drive (Windows 95 OSR2 or a third party IDE bus master driver). If your hard drive and your system software both support Ultra DMA/33, select Auto to enable BIOS support.

Auto (default)

IDE Burst Mode

Selecting Enabled reduced latency between each drive read/write cycle, but may cause instability in IDE subsystems that cannot support such fast performance. If you are getting disk drive errors, try setting this value to Disabled. This field does not appear when the internal PCI/IDE field, above, is Disabled.

Enabled (default)

IDE HDD Block Mode

The chipset contains a PCI IDE interface with support for two IDE channels. Select Enabled to activate the primary and/or secondary IDE interface. Select Disabled to deactivate this interface, if you install a primary and/or secondary add-in IDE interface IDE interface. This set KB/Mouse wake up the system from power down

Enabled (default)

Secondary HDD controller used.

Disabled

Secondary HDD controller not used.

Onboard FDC Controller

Enabled / Disabled The system has an onboard Super I/O chip with a FDD controller that supports 2 FDDs for 360K / 720K / 1.2M / 1.44M / 2.8M. Choose "Enabled" to use the onboard FDD controller for accessing the FDD. Otherwise choose "Disabled" to use the off-board FDD controller.

Onboard Serial Port 1

Disabled / (3F8 / IRQ4) / (2F8 / IRQ3) / (3E8 / IRQ4) / (2E8 / IRQ3)
Onboard Serial Port 2

Disabled / (3F8 / IRQ4) / (2F8 / IRQ3) / (3E8 / IRQ4) / (2E8 / IRQ3)

The system has an Onboard Super I/O chipset with 2 serial ports.

The Onboard serial ports can be selected as:

Disabled

3F8 / IRQ4 COM1 uses IRQ4

2F8 / IRQ3 COM2 uses IRQ3

3F8 / IRQ4 COM3 uses IRQ4

2F8 / IRQ3 COM4 uses IRQ3

UR2 Mode

This item allow you to determine which Infra Red (IR) function of onboard I/O chip.

Onboard Parallel Port

Disabled there is a built-in parallel port on the on-board Super I/O
(3BCH/IRQ7) Chipset that provides Standard, ECP, and EPP features.
(278H/IRQ5) It has the following options:

Disable

3BCH/IRQ7 Line Printer port 0

278H/IRQ5 Line Printer port 2

378H/IRQ5 Line Printer port 1

Parallel Port Mode

SPP : Standard Parallel Port (default)

EPP : Enhanced Parallel Port

ECP : Extended Capability Port

To operate the onboard parallel port as Standard Parallel Port only, choose "SPP." To operate the onboard parallel port in the ECP and SPP modes simultaneously, choose "ECP/SPP." By choosing "ECP" the onboard parallel port will operate in ECP mode only. Choosing "ECP/EPP" will allow the onboard parallel port to support both the ECP and EPP modes simultaneously. The ECP mode has to use a DMA channel so choose the onboard parallel port with the ECP feature. After selecting it the following message will appear: "ECP Mode Use DMA". At this time the user can choose between DMA channels 3 or 1. The onboard parallel port is EPP Spec. Compliant so after the user chooses the onboard parallel port with the EPP function, the following message will be

displayed on the screen: "Parallel port EPP Type." At this time either EPP 1.7 spec. Or EPP 1.9 spec. Can Be chosen.

PS/2 mouse function

This enable PS/2 Mouse
Enabled (default)

USB Controller

The default value is Disabled
Disabled Disable the onboard USB function.
Enabled (default) Enable the onboard USB function.

USB Keyboard Support

Select Enabled if your system contains a Universal Serial Bus (USB) controller and you have a USB keyboard.
Disabled (default)

Init Display First

This choose Display from PCI slot or AGP.
PCI slot (default)

VGA Shared Memory Size

This choose shared memory size for VGA.
4MB (default)

VGA Memory Clock (MHz)

This choose the frequency of VGA shared memory.
66 (default)

2.9 Password Setting

■ Figure 9. Password Setting

ROM PCI/ISA BIOS (xxxxxxx)
CMOS SETUP UTILITY
AWARD SOFTWARE, INC.

STANDARD CMOS SETUP	INTEGRATED PERIPHERALS
BIOS FEATURES SETUP	PASSWORD SETTING
CHIPSET FEATURES SETUP	IDE HDD AUTO DETECTION
POWER MANAGEMENT SETUP	SAVE & EXIT SETUP
PNP / PCI CO	Enter Password : _____ NG
LOAD SETUP DEFAULTS	
Esc : Quit F5 : Menu in BIOS ↑ ↓ → ← : Select Item	
F10 : Save & Exit Setup (Shift) F2 : Change Color	
Change / Set / Disable Password	

When you select this function, the following message will appear at the center of the screen to assist you in creating a password.

ENTER PASSWORD

Type the password, up to eight characters, and press <Enter>. The password you type now will clear any previously entered password from CMOS memory. You will be asked to confirm the password. Type the password again and press <Enter>. You may also press <ESC> to abort the selection and not enter a password. To disable password, just press <Enter> when you are prompted to enter password. A message will confirm that you wish to disable the password. Once the password is disabled, the system will boot and you can enter setup

freely.

PASSWORD DISABLED

If you select “System” at the Security Option of BIOS Features Setup Menu, you will be prompted for the password every time the system is rebooted or any time you try to enter Setup. If you select “Setup” at Security Option of BIOS Feature Setup Menu, you will be prompted only when you try to enter Setup.

2.10 IDE HDD Auto Detection

Automatically configure hard disk parameters. The parameters shown below are only examples.

■ Figure 10. Auto Configuration with Optimal Settings Screen

ROM PCI/ISA BIOS (xxxxxxx)
CMOS SETUP UTILITY
AWARD SOFTWARE, INC.

HARD DISKS	TYPE	SIZE	CYLS	HEAD	PRECOMP	LAND	SECTOR	MODE
Primary Master	:User	343	665	16	65535	664	63	NORMAL

Select Primary Slave Option (N=Skip) N								
OPTIONS	SIZE	CYLS	HEAD	PRECOMP	LANDZ	SECTOR	MODE	
1(Y)	0	0	0	0	0	0	NORMAL	

Note : Some OSes (like SCO-UNIX) must use "NORMAL" for installation

ESC : Skip

When you enter this utility, the screen asks you to select a specific hard disk for Primary Master. If you accept a hard disk detected by the BIOS, you can enter "Y" to confirm and then press <Enter> to check next hard disk. This function allows you to check four hard disks and you may press the <Esc> after the <Enter> to exit this function and go back to the Main Menu.

2.11 Save & Exit Setup

Save CMOS value changes to CMOS and exit setup.

■ **Figure 11. Save & Exit Setup Screen**

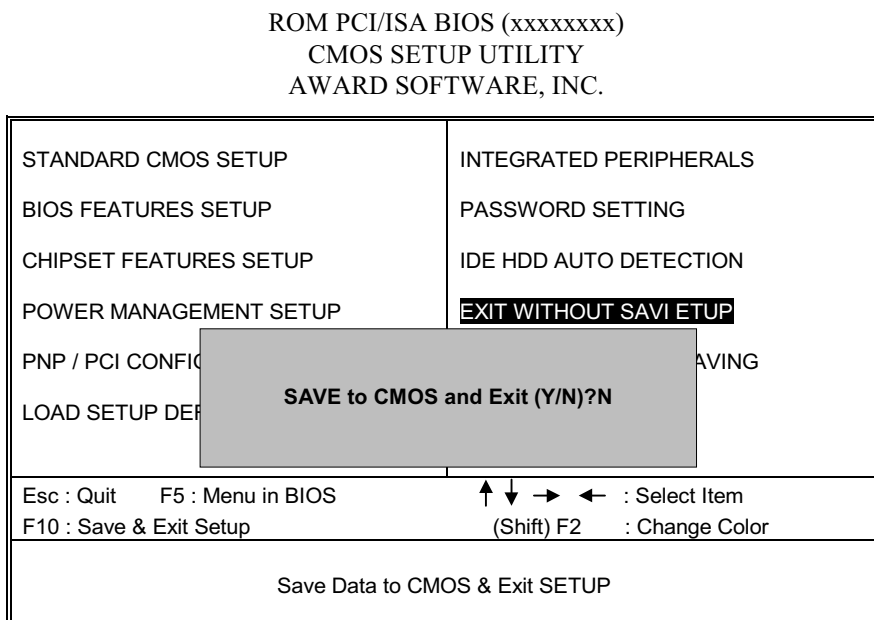

Pressing <N> and <ENTER> will return you to the Main Menu.

Pressing <Y> and <ENTER> will save the system parameters and continue with the booting process.

2.12 Exit Without Saving

Abandon all CMOS value changes and exit setup.

■ Figure 12. The Save Settings and Exit Screen

ROM PCI/ISA BIOS (xxxxxxxx)
CMOS SETUP UTILITY
AWARD SOFTWARE, INC.

STANDARD CMOS SETUP	INTEGRATED PERIPHERALS
BIOS FEATURES SETUP	PASSWORD SETTING
CHIPSET FEATURES SETUP	IDE HDD AUTO DETECTION
POWER MANAGEMENT SETUP	LOAD SETUP DEFAULT VALUES
PNP / PCI CONFIGURATION	REBOOT SETUP
LOAD SETUP DEFAULT VALUES	REBOOT SETUP
Quit Without Saving (Y/N)?N	
Esc : Quit F5 : Menu in BIOS ↑ ↓ → ← : Select Item F10 : Save & Exit Setup (Shift) F2 : Change Color	
Abandon All Data & Exit SETUP	

Pressing <N> and <ENTER> will return you to the Main Menu.

Pressing <Y> and <ENTER> will continue with booting process without saving any system parameters.

2.13 Application Software

- Please use the "BIOS Utility" diskette to setup Flash Memory.
- The diskette contains the intelligent installation utility **AWDFLASH.EXE**, displayed below.

■ **Figure 13. Flash Memory Writer**

FLASH MEMORY WRITER Vxx	
Copyright (C) 1992-1994 Award Software, Inc.,	
For xx-xxxxxxxxxxxxxxxxxxxx	DATE: xx/xx/xxxx
Flash Type -	
File Name to Program:	<input type="text"/>
Error Message :	Do You Want To Save Bios (Y/N)?

3. Software

3.1 Motherboard Software

3.1.1 Software List

NOTE: The mark * means it can be installed directly from CD by using CD Installation Utility (i.e. START.EXE).

Category	Description	Platform	Location in CD
SiS 620 VGA Driver *	Drivers for SiS 620 VGA	Windows 95/98/NT40	\Mb_drv\Vga
SiS IRQ Routing Miniport Patch *	Used for enable PCI bus IRQ Steering function.	Win95(OSR2.1 only)	\Mb_drv\Sisirq
HighPoint XStore Pro *	Install the drivers to support Ultra DMA mode Hard Drive.	Windows 95/98	\Mb_drv\XStore
SiS Bus Master IDE Drivers *	Install the drivers to support Ultra DMA mode Hard Drive.	Windows NT4.0	\Mb_drv\Ide
SiS System Hardware Monitor *	Hardware Monitor is a self-diagnostic system for PC.	Windows 95/98/NT40	\Mb_drv\Hwmon
Award Flash Utility	Used for updating BIOS. (Please refer to chapter - Application Software.)		\Mb_drv \Flash

3.1.2 Software Installation

There is an installation wizard, **Driver CD Installation Utility** (START.EXE), located in the root of Driver CD to let users install some common used drivers conveniently.

➤ **The drivers can be installed from CD by using CD Installation Utility:**

You can simply put Driver CD into CD-ROM drive and the Installation Utility will autorun or you can run the Driver CD Installation Utility directly by using mouse cursor to click the proper option on the page. Utility will invoke other applications to complete the rest of installation.

➤ **The drivers CAN NOT be installed directly from CD by using CD Installation Utility:**

Please read the README.TXT located in the root directory on Multimedia CD to get drivers' location and then refer to the INSTALL.TXT or README.TXT files located in each driver directory on the Driver CD to install drivers.

3.1.3 Using Software

- **In general, you can get more detailed information in the on-line help or readme for the softwares.**
- **Using SiS System Hardware Monitor**
After the utility is installed, you can see a tiny icon in the right side of the Task Bar and you can click the icon to invoke the utility again.

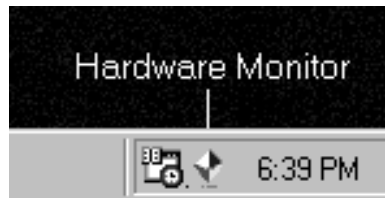

The following figure is the main panel of SiS System Hardware Monitor. In the panel, you can get some real-time and important information -- Voltage, Fan speed, and temperature, for example. If there is an abnormal situation, you can resolve it immediately.

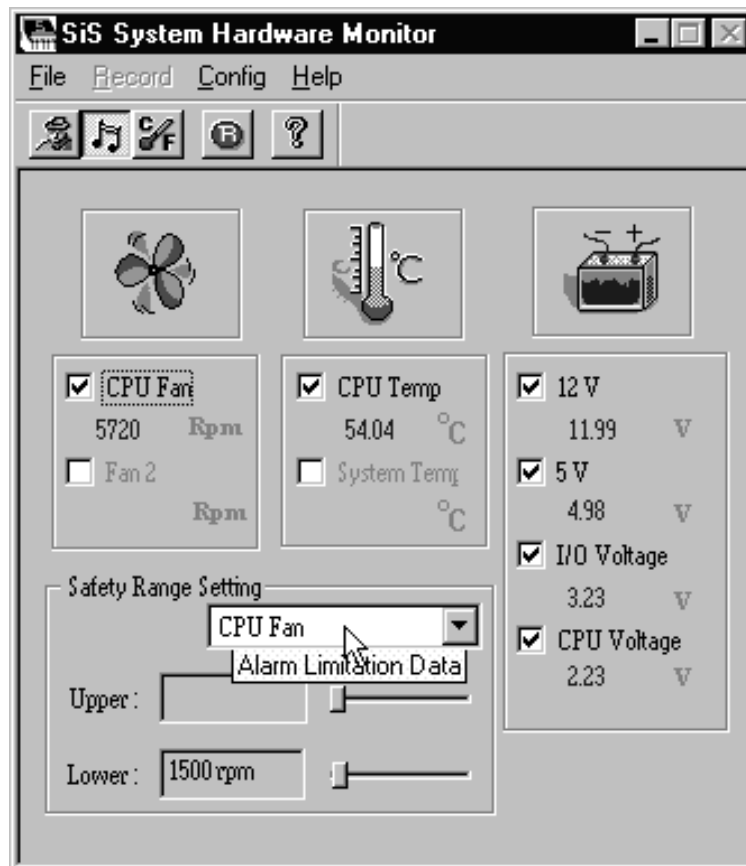

If you want to get more detailed information about SiS System Hardware Monitor, on-line help comes with the utility. You can refer to on-line help to make use of the utility.



4. Trouble Shooting

PROBLEM

No power to the system at all. Power light does not illuminate, fan inside power supply does not turn on. Indicator light on keyboard does not turn on.

PROBABLE CAUSE	DIAGNOSIS	SOLUTION
Power cable is unplugged.	Visually inspect power cable.	Make sure power cable is securely plugged in.
Defective power cable.	Visual inspection, try another cable.	Replace cable.
Power supply failure.	Power cable and wall socket are OK, but system is still dead.	Contact technical support.
Faulty wall outlet; circuit breaker or fuse blown.	Plug in device known to work in socket and test.	Use different socket, repair outlet, reset circuit breaker or replace fuse.

PROBLEM

System inoperative. Keyboard lights are on, power indicator lights are lit, hard drive is spinning.

PROBABLE CAUSE	DIAGNOSIS	SOLUTION
Expansion card is partially dislodged from expansion slot on the motherboard.	Turn off computer. Take cover off system unit. Check all expansion cards to ensure they are securely seated in slots.	Using even pressure on both ends of the expansion card, press down firmly on expansion card.
Defective floppy disk drive or tape drive.	Turn system off. Disconnect the cables from one of the floppy drives. Turn on the floppy drives. Turn on the system, check to see if the keyboard operates normally. Repeat until you have located defective unit.	Contact Technical Support.
Defective expansion card.	Turn computer off. Remove an expansion card.	Make sure expansion card is secure in expansion socket.

PROBLEM

System does not boot from hard disk drive, can be booted from floppy disk drive.

PROBABLE CAUSE	DIAGNOSIS	SOLUTION
Connector between hard drive and system board unplugged.	When attempting to run the FDISK utility described in the HARD DISK section of this manual you get a message, INVALID DRIVE SPECIFICATION.	Check cable running from disk to disk controller board. Make sure both ends are securely plugged in; check the drive type in the Standard CMOS Setup (see HARD DISK section of this manual).
Damaged Hard Disk or Disk Controller.	Format hard disk; if unable to do so the hard disk may be defective.	Contact Technical Support.
Hard Disk directory or FAT is scrambled.	Run the FDISK program, format the hard drive (see HARD DRIVE section of manual). Copy data that was backed up onto Hard Drive.	Backing up the hard drive is extremely important. All Hard Disk are capable of breaking down at any time.

PROBLEM

System only boots from floppy Disk. Hard disk can be read and applications can be used but booting from Hard Disk is impossible.

PROBABLE CAUSE	DIAGNOSIS	SOLUTION
Hard Disk boot program has been destroyed.	A number of causes could be behind this.	Back up data and applications files. Reformat the Hard Drive as described in the Hard Drive section of this manual. Re-install applications and data using backup disks.

PROBLEM

Error message reading "SECTOR NOT FOUND" or other error messages not allowing certain data to be retrieved.

PROBABLE CAUSE	DIAGNOSIS	SOLUTION
A number of causes could be behind this.	Use a file by file backup instead of an image backup in order to backup the Hard Disk.	Back up any salvageable data. Then low level format, partition, and high level format the hard drive (see Hard Disk section of this manual for instructions). Re-install all saved data when completed.

PROBLEM

Disk formatted on IBM PS/2 will not operate with this system.

PROBABLE CAUSE	DIAGNOSIS	SOLUTION
The IBM PS/2 uses a different format than other computers.	IBM PS/2 disk format will not work in an AT type computer.	Format disk in the AT type computer insert disk into the IBM PS/2 and copy the files you wish.

PROBLEM

After installing an expansion card (network card, tape drive card, etc.) the system no longer works properly.

PROBABLE CAUSE	DIAGNOSIS	SOLUTION
No power to monitor.	All or part of the system may be inoperable. The new card may work but a mouse or COM port may not work.	Change the interrupt or RAM address on the new expansion card. See the documentation that came with the new card in order to change pin settings. Many expansion devices come with proprietary software that will assist you in doing this.

PROBLEM

Screen message says “Invalid Configuration” or “CMOS Failure.”

PROBABLE CAUSE	DIAGNOSIS	SOLUTION
Incorrect information entered into the configuration (setup) program.	Check the configuration program. Replace any incorrect information.	Review system's equipment . Make sure correct information is in setup.

PROBLEM

Screen is blank.

PROBABLE CAUSE	DIAGNOSIS	SOLUTION
No power to monitor.		Check the power connectors to monitor and to system. Make sure monitor is connected to display card, change I/O address on network card if applicable.
Monitor not connected to computer.		See instructions above.
Network card I/O address conflict.		See instructions above.

PROBLEM

PROBABLE CAUSE	DIAGNOSIS	SOLUTION
Memory problem, display card jumpers not set correctly.		Reboot computer. Reinstall memory, make sure that all memory modules are installed in correct sockets. Check jumper and switch settings on display card. See display card section for information on settings.
Computer virus.		Use anti-virus programs (McAfee, E-Prot, etc) to detect and clean viruses.

PROBLEM

Screen goes blank periodically.

PROBABLE CAUSE	DIAGNOSIS	SOLUTION
Screen saver is enabled.		Disable screen saver.

PROBLEM

Keyboard failure.

PROBABLE CAUSE	DIAGNOSIS	SOLUTION
Keyboard is disconnected.		Reconnect keyboard. Check keys again, if no improvement replace keyboard.

PROBLEM

No color on screen.

PROBABLE CAUSE	DIAGNOSIS	SOLUTION
Faulty Monitor.		If possible, connect monitor to another system. If no color replace monitor.
CMOS incorrectly set up.		Call technical support.

PROBLEM

Floppy drive light stays on.

PROBABLE CAUSE	DIAGNOSIS	SOLUTION
Floppy Drive cable not connected correctly.		Reconnect floppy cable making sure PIN1 on the Floppy Drive corresponds with PIN1 on Floppy cable connector.

PROBLEM

Error reading drive A:

PROBABLE CAUSE	DIAGNOSIS	SOLUTION
Bad floppy disk.		Try new floppy disk
Floppy disk not formatted		Format floppy disk (type FORMAT A:type ENTER).

PROBLEM

C: drive failure.

PROBABLE CAUSE	DIAGNOSIS	SOLUTION
SETUP program does not have correct information.		Boot from drive A: using DOS system disk. Input correct information to SETUP program.
Hard Drive cable not connected properly.		Check Hard Drive cable.

PROBLEM

Cannot boot system after installing second hard drive.

PROBABLE CAUSE	DIAGNOSIS	SOLUTION
Master/Slave jumpers not set correctly.		Set Master/Slave jumpers correctly.
Hard Drives not compatible / different manufacturers.		Run SETUP program and select correct drive types. Call Drive manufacturers for compatibility with other drives.

PROBLEM

Missing operating system on hard drive.

PROBABLE CAUSE	DIAGNOSIS	SOLUTION
CMOS setup has been changed.		Run setup and select correct drive type.

PROBLEM

Certain keys do not function.

PROBABLE CAUSE	DIAGNOSIS	SOLUTION
Keys jammed or defective.		Replace keyboard.

PROBLEM

Keyboard is locked, no keys function.

PROBABLE CAUSE	DIAGNOSIS	SOLUTION
Keyboard is locked.		Unlock keyboard.

04/06/1999
MADE IN TAIWAN
R.O.C