Federal Communications Commission (F.C.C) Statement

This device complies with Part 15 of the FCC Rules. Operation of this device is subject to the following two conditions: (1) this device may not cause harmful interference, and (2) this device must accept any interference received, including interference that may cause undesired operation.

Accessories: This device has been tested and found to comply with the limits of a Class B digital device, the accessories associated with this equipment are as follows:

1. Shielded serial cable. (Can be obtained from multiple retail outlets)
2. Shielded printer cable. (Can be obtained from multiple retail outlets)
3. Shielded video cable. (Can be obtained from multiple retail outlets)
4. Shielded power cord. (Provided by manufacturer)

These accessories are required to be used in order to ensure compliance with FCC Rules. It is the responsibility of the user to provide and use these accessories properly.

This equipment has been tested and found to comply with the limits of a Class B digital device, pursuant to Part 15 of the FCC Rules. These limits are designed to provide reasonable protection against harmful interference in a residential installation. This equipment generates, uses and can radiate radio frequency energy and, if not installed and used in accordance with the instructions, may cause harmful interference to radio communications. However, there is no guarantee that interference will not occur in a particular installation. If this equipment does cause harmful interference to radio or television reception, which can be determined by turning the equipment off and on, the user is encouraged to try to correct the interference by one or more of the following measures:

1. Reorient / Relocate the receiving antenna.
 2. Increase the separation between the equipment and receiver.
 3. Connect the equipment into an outlet on a circuit different from that to which the receiver is connected.
-

4. Consult the dealer or an experienced radio/TV technician for help.

Caution: Changes or modifications not expressly approved by the manufacturer could void the user's authority to operate the equipment.

Disclaimer

The Vendor makes no representations or warranties with respect to the contents here of and specially disclaims any implied warranties of merchantability or fitness for any purpose. Further the Vendor reserves the right to revise this publication and to make changes from time to time in the contents here of without obligation to notify any party beforehand. Duplication of this publication, in part or in whole, is not allowed without first obtaining the Vendor's approval in writing.

Trademarks and Remarks

MS-DOS, Windows, Windows NT, and Windows 9x are products of Microsoft Corp, with its ownership of trademark, and are distributed by the Vendor under a license agreement.

All trademarks used in this manual are the property of their respective owners.

Copyright(C) 1992
All Rights Reserved

Canadian D.O.C. Statement

This digital apparatus does not exceed the Class B limits for radio noise emissions from digital apparatus as set out in the radio interference regulations of the Canadian Department of Communications.

Cet appareil numérique n'émet pas de bruits radioélectriques dépassant les limites appliqués aux appareils numériques de Class B prescrits dans le règlement du brouillage radioélectrique édicté par le ministère Des Communications du Canada.

Contents

Introduction	1-1
1 Motherboard Description	1-2
1.1 Features	1-2
1.1.1 Hardware	1-2
1.1.2 Software	1-5
1.1.3 Attachments.....	1-6
1.2 Motherboard Installation.....	1-7
1.2.1 Layout of Motherboard	1-7
1.3 Motherboard Connectors and Headers.....	1-8
1.3.1 Front Panel Connectors (JPANEL1)	1-10
1.3.2 ATX 20-pin Power Connector (PWR)	1-12
1.3.3-4 Hard Disk Connectors (IDE1/IDE2).....	1-13
1.3.5 Floppy Disk Connector (FDD).....	1-13
1.3.6 Chassis open Detection Header (JINTRD1).....	1-13
1.3.7 SB-LINK Header (JSBLNK1)	1-13
1.3.8 CPU Fan Header (JFAN1)	1-14
1.3.9 Chassis Fan Header (JFAN2).....	1-14
1.3.10 Wake On Modem Header (JWOM1)	1-14
1.3.11 Wake-On-LAN Header (JWOL1)	1-14
1.4 Back Panel Connectors	1-15
1.4.1 PS/2 Mouse / Keyboard Connector (JKBMS1).....	1-15
1.4.2 USB/LAN Connectors (JLAN1)	1-16

Contents

1.5 Serial and Parallel Interface Ports	1-19
1.6 CPU Installation.....	1-22
1.6.1 CPU Processor	1-22
1.6.2 CPU Installation Procedure.....	1-23
1.7 Jumper Settings	1-27
1.7.1 USB Location Selection (JFUSEL1).....	1-28
1.7.2 CMOS Function Selection (JCMOS1)	1-28
1.7.3 Mouse and Keyboard Power source Selection (JVKM1).....	1-28
1.7.4 USB Power Source Selection (JVUSB1)	1-28
1.8 RIMM Installation.....	1-29
1.8.1 System Memory.....	1-29
1.8.2 RIMM.....	1-32
1.9 Audio Subsystem.....	1-33
1.9.1 ATAPI Style CD ROM Audio In Header (JCDIN1).....	1-33
1.9.2 Legacy –style ,2mm CD ROM Audio-In Header (JCDIN2)	1-34
1.9.3 Telephony ATAPI style Header(JTAD1).....	1-34
1.9.4 Auxiliary ATAPI style Audio in Header (JJAUX1).....	1-34
2. BIOS Setup.....	2-1
2.1 Main	2-2
2.2 Advanced CMOS Setup	2-6
2.3 Advanced Chipset Setup	2-11
2.4 Power Management Setup.....	2-14
2.5 Plug and Play Setup	2-18

Contents

2.6 Peripheral Setup	2-21
2.7 Hardware Monitor Setup.....	2-25
2.8 Set Supervisor Password	2-27
2.9 Set Keyboard Wake up Password	2-28
2.10 Exit Saving Changes	2-29
2.11 Exit Discarding Changes.....	2-30
2.12 Load Optimal Settings.....	2-31
2.13 Load Fail Safe Settings	2-32
2.14 Load Original Values	2-33
3 Software.....	3-1
3.1 Software List	3-1
3.2 Software Installation	3-3
3.3 Software Usage	3-6
4 Trouble Shooting	4-22

Introduction

System Overview

Thanks for buying this product! This manual was written to help you start using this product as quickly and smoothly as possible. Inside you will find adequate explanations to solve most problems. In order for this reference material to be of greatest use, refer to the “expanded table of contents” to find relevant topics.

This board incorporates the all new Intel® 820 chipset, built-in 4xAGP , Fast ethernet 10/100Mbps(optional), the LPC I/O, and Fast IDE into one board that provides a total PC solution. The motherboard supports Deschutes or Coppermine processor based Micro ATX system, RIMMS to offer flexible memory expensive solution, AGP universal connector supporting 1X,2X and 4X AGP cards,PCI Local Bus to support upgrades your system performance. On-Board sound subsystem to support high 3D sound quality.It is ideal for multi-tasking and fully supports MS-DOS, Windows 3X, Windows NT, Windows 2000, Novell, OS/2, Windows9x, UNIX, SCO UNIX etc. This manual also explains how to install the motherboard for operation, and how to setup your CMOS configuration with the BIOS setup program.

1 Motherboard Description

1.1 Features

1.1.1 Hardware

CPU

- Support for Pentium® II and Pentium®!!! processor at 100/133 MHZ FSB frequency.

RIMM Memory

- Supports 300 & 400 MHZ Direct Rambus* channel @100MHZ or 133MHZ host front side bus frequency.
- Supports for up to 512MB system memory.

Shadow RAM

- A memory controller that provides shadow RAM.

Green Function

- Supports power management operation via BIOS.
- Power down timer from 1 min to 1 Hour.
- Wakes up by any key pressed or mouse activity.
- Wake On LAN header.
- Wake On internal MODEM header.
- S3 (suspend to RAM) support.

BUS Slots

- PCI Bus Specification Revision 2.2 .
- Provides three PCI Bus slots.
- Provides AGP universal connector supporting 1X,2X and 4X AGP cards.

Fast IDE Built-in Onboard

- Supports 4 IDE hard disk drives.
- Supports PIO mode 4, Transfers up to 14 M bytes/S
- Supports Ultra DMA/33 and Ultra DMA/66 Bus Master Mode.
- Supports IDE interface with CD-ROM.
- Supports high capacity hard disk drives.
- Supports LBA mode.
- Driver type detected by BIOS.

PCI-Based AC 97 Digital Audio Processor (Optional)

- 64 voice wavetable synthesis.
- DOS Game Compatibility.
- Uses a single sharable PCI Interrupt.
- Multiple sample rate support.
- CD audio over the PCI bus.
- Tone Control.
- Speaker EQ.
- PCI Bus Master for fast DMA.
- Sounds are stored in Host memory.
- Sound Library of over 4000 Sounds.
- 3 Stereo inputs and 3 mono inputs can be mixed into the output stream.
- Direct I/O space access of the control registers.
- Digital output compatible with consumer mode SPDIF.
- Fully Compliant with PC97 Power Management specification.

AC'97 Sound Codec Onboard***AC'97 FEATURES.***

- Variable Sample Rate.
- True Line-Level Output.
- Multibit $\Sigma \Delta$ Converter Architecture for Improved S/N Ratio greater than 90dB.
- 18-Bit stereo Full-Duplex Codec.
- Two Analog Line-Level Stereo Inputs for Connection from LINE, CD.
- Two Analog Line-Level Mono Inputs for Speakerphone and PC BEEP.
- Mono MIC Input Switchable from Two External Sources.

- High Quality CD Input with Ground Sense.
- Stereo Line Level Output.
- Mono Output for speakerphone.
- Mobile Low Power Mixer Mode.
- Digital Audio Mixer Mode.
- DSP 16-Bit Serial Port Format, Slot 16 Mode.
- Full Duplex Variable 7 KHz to 48 KHz Sampling Rate with 1 Hz Resolution.
- Phat™ 3D Stereo Enhancement.

LPC I/O Built-in Onboard

- Meet LPC Spec. 1.0.
- Compliant with Microsoft PC98/PC99.
- Support DPM (Device Power Management),ACPI.
- Compatible with IBM PC AT disk drive systems.
- Support floppy disk drives and tape drives.
- Support up to two 3.5-inch or 5.25-inch floppy disk drives.
- 360K/720K/1.2M/1.44M/2.88M format; 250K, 300K, 500K, 1M, 2M bps data transfer rate.
- Support 3-mode FDD, and its Win95/98 driver.
- Two high-speed 16550 compatible UARTs with 16-byte send/receive FIFOs.
- Support IrDA version 1.0 SIR protocol with maximum baud rate up to 115.2K bps.
- Compatible with IBM parallel port.
- Support PS/2 compatible bi-directional parallel port.
- Support Enhanced Parallel port (EPP) _Compatible with IEEE 1284 specification.
- Support Extended Capabilities port (ECP) – Compatible with IEEE 1284 specification.
- Enhanced printer port back-drive current protection.
- Support PS/2 mouse.
- Support joysticks.
- Support every joystick two axis (X,Y) and two button (A,B) controllers.
- The MIDI Port baud rate is 31.25K baud.
- Keyboard Wake-Up.(Optional)
- Mouse Wake-Up. (Optional)

- 5 VID input pins for CPU Vcore identification.
- 1 thermal inputs from Pentium™ II / III serial CPU thermal diode output.
- 6 positive voltage inputs (typical for +12V, -12V, +5V, +3.3V, Vcore, VTT).
- 2 fan speed monitoring inputs and fan speed control.
- Build in Case open detection header.
- Programmable hysteresis and setting points for all monitored items.
- Over temperature indicate output.
- Automatic power On voltage detection Beep.

System Speed Selection

- Front side bus frequency may selected by BIOS.

Universal Serial Bus

- UHCI Implementation with 2 ports.

Fast ethernet LAN (Optional)

- Integrated IEEE 802.3 10BASE-TX compatible PHY.
- WfM 2.0 compliance.
- ACPI 1.20A, and PCI Power Management specifications compliance.
- Magic Packet* support.
- Wake on interesting packets and link status change support.
- Remote power-up support.
- Full duplex support at both 10 and 100 Mbps operation.
- Support Alert on LAN 2.(Optional)

Dimension (Micro ATX form-factor)

- 24.4cm X 20.8 cm (W x L)

1.1.2 Software**BIOS**

- AMI BIOS.
- ACPI Supported.

- Plug and Play.
- Supports APM1.2.
- Supports USB Function.

Operating Systems

- Offers the highest performance for MS-DOS, OS/2, Windows 3X, Windows NT, Windows 2000 ,Windows 9x, Novell, UNIX, SCO UNIX etc.

1.1.3 Attachments

- HDD Cable.
- FDD Cable.
- Rear I/O Panel shield for ATX Case (Optional).
- CD for sound,IDE drivers.
- Front USB cable (Optional).

1.3 Motherboard Connectors and Headers

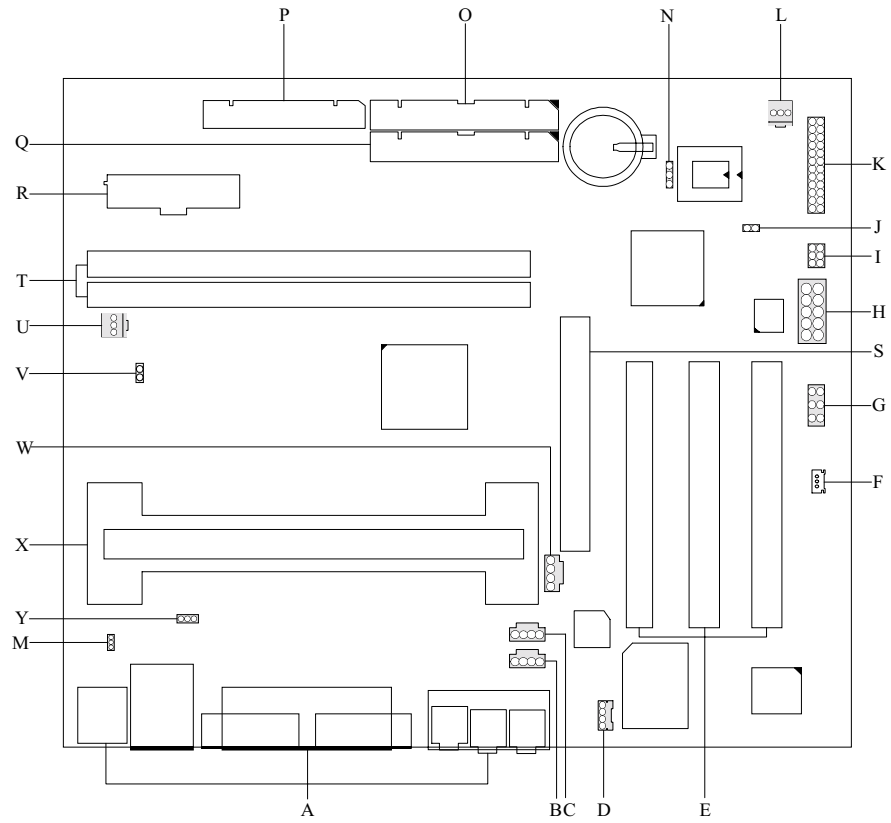

-
- | | |
|--|--|
| A. Back Panel Connector | N. Clear CMOS selection (JCMOS1) |
| B. ATAPI style CD-ROM Audio in
HEADER (JCDIN1) | O. Primary IDE CONN. (IDE1) |
| C. Telephony ATAPI style HEADER (JTAD1) | P. FDD Connector (FDD) |
| D. Legacy-style, 2mm CD-ROM Audio
Input HEADER (JCDIN2) | Q. Secondary IDE CONN. (IDE2) |
| E. PCI BUS SLOT (PCI1-3) | R. ATX Power CONN. (PWR) |
| F. Wake-On LAN HEADER (JWOL1) | S. AGP SLOT (AGP1) |
| G. Sound Blast Link HEADER (JSBLNK1) | T. RIMM Socket (RIMM1-2) |
| H. Front Panel USB HEADER (JFUSB1) | U. CPU FAN HEADER (JFAN1) |
| I. Front/Rear Panel
Selection (JFUSEL1) | V. Chassis Open Detection HEADER
(JINTRD1) |
| J. Wake on Modem HEADER (JWOM1) | W. Auxiliary ATAPI style
Audio in HEADER (JJAUX1) |
| K. Front Panel CONN. (JPANEL1) | X. CPU SLOT (SLT1) |
| L. Chassis FAN HEADER (JFAN2) | Y. USB Power source selection
(JVUSB1) |
| M. Keyboard and Mouse Power
Source Selection (JVKM1) | |
-

1.3.1 Front Panel Connectors (JPANEL1)

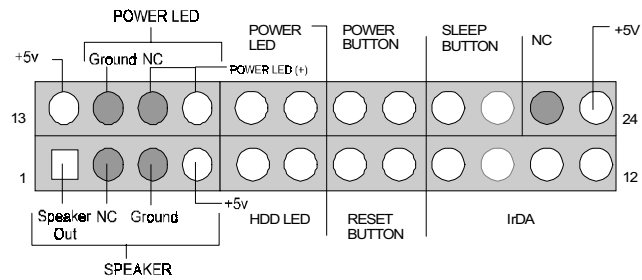

Pin No.	Assignment	Function	Pin No.	Assignment	Function
1	Speaker	PC Speaker Connector	13	+5V	VCC
2	NC		14	Ground	POWER LED
3	Ground		15	POWER LED (+)	
4	+5V		16	POWER LED (-)	Power LED
5	HDD LED (+)	Hard Drive LED	17	Power LED (+)	Power LED
6	HDD LED (-)		18	Power LED (-)	
7	Ground	Reset button	19	Power Button	Power Button
8	Reset control		20	Ground	
9	+5V	IrDA Connector	21	Sleep Control	Sleep Button
10	Ir-IN		22	Ground	
11	Ground		23	No Connection	No Connection
12	Ir-out		24	+5V	

Speaker Connector

An offboard speaker can be installed on the motherboard as a manufacturing option. An offboard speaker can be connected to the motherboard at the front panel connector. The speaker (onboard or offboard) provides error beep code information during the Power On Self-Test when the computer cannot use the video interface. The speaker is not connected to the audio subsystem and does not receive output from the audio subsystem.

Reset Button

This connector can be connected to a momentary SPST type switch that is normally open. When the switch is closed, the motherboard resets and runs the POST.

Power LED Connector

This connector can be connected to an LED that will light when the computer is powered on.

Hard Drive LED Connector

This connector can be connected to an LED to provide a visual indicator that data is being read from or written to a hard drive. For the LED to function properly, an IDE drive must be connected to the onboard hard drive controller.

Infrared Connector

After the IrDA interface is configured, files can be transferred from or to portable devices such as laptops, PDAs, and printers using application software.

Sleep Button

When APM is enabled in the system BIOS, and the operating system's APM driver is loaded, the system can enter sleep (standby) mode in one of the following ways.

Power On Button

This connector can be connected to a front panel power switch. The switch must pull the Power Button pin to ground for at least 50 ms to signal the power supply to switch on or off. (The time requirement is due to internal denounce circuitry on the motherboard.) At least two seconds must pass before the power supply will recognize another on/off signal.

1.3.2 ATX 20-pin Power Connector (PWR)

This connector supports the power button on-board. Using the ATX power supply, functions such as Modem Ring Wake-Up and Soft Power Off are supported on this motherboard. This power connector supports instant power-on functionality, which means that the system will boot up instantly when the power connector is inserted on the board.

PIN	VOLTAGE	PIN	VOLTAGE
1	3.3 V	11	3.3 V
2	3.3 V	12	-12 V
3	GND	13	GND
4	5 V	14	PS_ON
5	GND	15	GND
6	5 V	16	GND
7	GND	17	GND
8	PW_OK	18	-5 V (Optional)
9	5V_SB	19	5 V
10	12 V	20	5 V

Warning: Since the motherboard has the instant power-on function, make sure that all components are installed properly before inserting the power connector to ensure that no damage will be done.

1.3.3-4 Hard Disk Connectors (IDE1/IDE2)

The motherboard has a 32-bit Enhanced, PCI IDE Controller that provides PIO Mode 0~4, and Ultra DMA 33/ 66 functionality. It has two HDD connectors IDE1 (primary) and IDE2 (secondary). You can connect up to four hard disk drives, a CD-ROM, a 120MB Floppy (reserved for future BIOS) and other devices to IDE1 and IDE2. These connectors support the IDE hard disk cable provided.

- **IDE1 (Primary IDE Connector)**

The first hard drive should always be connected to IDE1. IDE1 can connect a Master and a Slave drive. You must configure the second hard drive on IDE1 to Slave mode by setting the jumper accordingly.

- **IDE2 (Secondary IDE Connector)**

The IDE2 controller can also support a Master and a Slave drive. The configuration is similar to IDE1. The second driver on this controller must be set to slave mode.

1.3.5 Floppy Disk Connector (FDD)

The motherboard provides a standard floppy disk connector (FDC) that supports 360K, 720K, 1.2M, 1.44M and 2.88M floppy disk types. This connector supports the provided floppy drive ribbon cables.

1.3.6 Chassis open Detection Header (JINTRD1)

Pin No.	Signal Name
1	Input Signal
2	Ground

1.3.7 SB-LINK Header (JSBLNK1)

Pin.	Assignment	Pin.	Assignment
1	DGNT	2	Ground
3	No connection	4	DREQ
5	Ground	6	Serial IRQ

1.3.8 CPU Fan Header (JFAN1)

Pin No.	Assignment
1	Ground
2	+12V
3	FAN R.P.M. Signal input

1.3.9 Chassis Fan Header (JFAN2)

Pin No.	Assignment
1	Ground
2	+12V
3	FAN R.P.M. Signal input

1.3.10 Wake On Modem Header (JWOM1)

PIN NO.	Assignment
1	Ground
2	Ring -in Signal input

1.3.11 Wake-On-LAN Header (JWOL1)

Pin No.	Assignment
1	+ 5V Standby Voltage
2	Ground
3	Wakeup Signal Input

1.4 Back Panel Connectors

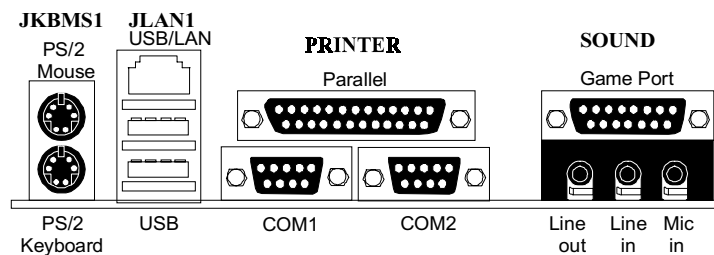

Note: LAN connector Optional.

1.4.1 PS/2 Mouse / Keyboard Connector (JKBMS1)

The motherboard provides a standard PS/2 mouse / Keyboard mini DIN connector for attaching a PS/2 mouse. You can plug a PS/2 mouse / Keyboard directly into this connector. The connector location and pin definition are shown below:

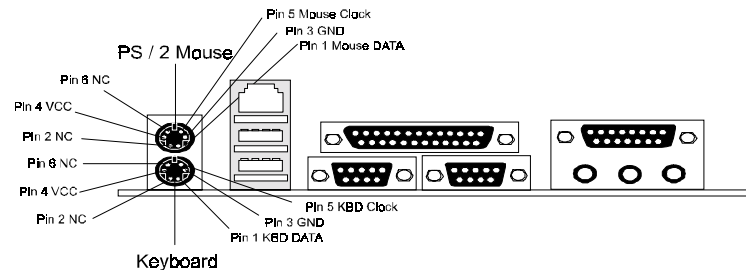

PS/2 Mouse / Keyboard Connectors

Pin	Signal Name
1	Data
2	No connect
3	Ground
4	+5 V (fused)

5	Clock
6	No connect

1.4.2 USB/LAN Connectors (JLAN1)

The motherboard provides a UHCI (Universal Host Controller Interface) Universal Serial Bus roots for attaching USB devices such as: keyboard, mouse and other USB devices. You can plug the USB devices directly into this connector.

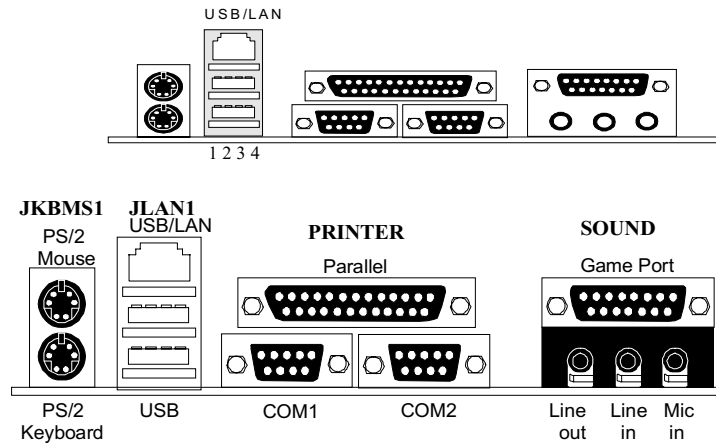

Note: LAN connector (RJ-45) is Optional.

USB Connectors

Pin	Signal Name
1	+5 V (fused)
2	USBP0- [USBP1-]
3	USBP0+ [USBP1+]
4	Ground

Note: (1) Signal names in brackets ([]) are for USB port 1.

(2) Please see the setting description of JFUSEL1 for detail USB function selection.

LAN Connector(Optional)

Pin	Signal Name	Pin	Signal Name
1	TDP	7	NC
2	TDN	8	NC
3	RDP	9	ACTLED
4	NC	10	LILED
5	NC	11	current limit resistor for LED
6	RDN	12	Speed LED

Front USB Connector (JFUSB1)

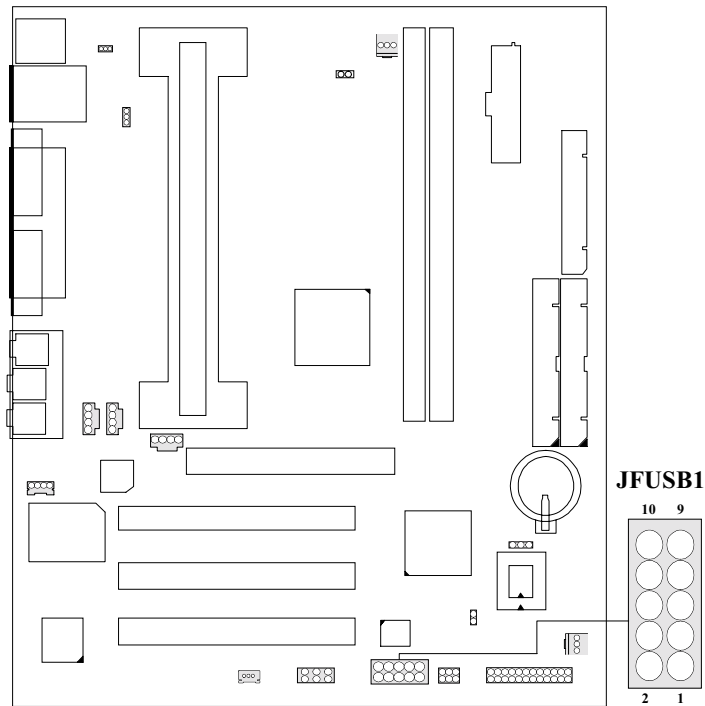

Pin	Signal Name	Pin	Signal Name
1	N/C	2	+5V
3	Ground	4	NC
5	NC	6	FNT_USBP0
7	Ground	8	FNT_USBP0#
9	Ground	10	Key

Note: Please see the setting description of JFUSEL1 for detail USB function selection.

1.5 Serial and Parallel Interface Ports

This system comes equipped with two serial ports and one parallel port. Both types of interface ports will be explained in this chapter.

The Serial Interface : COM1/COM2

The serial interface port is sometimes referred to as an RS-232 port or an asynchronous communications port. Mice, printers, modems and other peripheral devices can be connected to a serial port. The serial port can also be used to connect your computer with another computer system. If you wish to transfer the contents of your hard disk to another system it can be accomplished by using each machine's serial port.

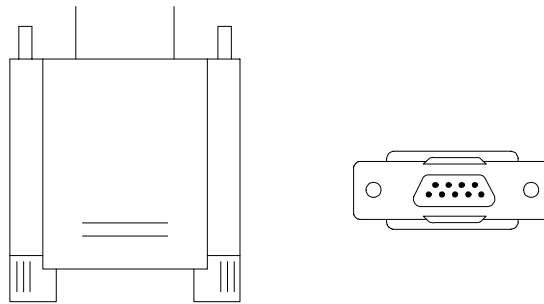

The serial ports on this system have two 9-pin connector. Some older computer systems and peripherals used to be equipped with only one 25-pin connector. Should you need to connect your 9-pin serial port to an older 25-pin serial port, you can purchase a 9-to-25 pin adapter.

Connectivity

The serial port can be used many ways, and it may be necessary to become familiar with the pin-out diagram. The following chart gives you the function of each pin on the 9-pin connector and some of the 25-pin connector. This information can be used when configuring certain software programs to work with the serial port.

Signal	Name	DB9 PIN	DB25 PIN
DCD	Data Carrier Detect	1	8
RX	Receive Data	2	3
TX	Transmit Data	3	2
DTR	Data Terminal Ready	4	20
GND	Signal Ground	5	7
DSR	Data Set Ready	6	6
RTS	Request to Send	7	4
CTS	Clear to Send	8	5
RI	Ring Indicator	9	22

Parallel Interface Port (Printer)

Unlike the serial port, parallel interface ports have been standardized and should not present any difficulty interfacing peripherals to your system. Sometimes called a Centronics port, the parallel port is almost exclusively used with printers. The parallel port on your system has a 25-pin, DB5 connector (see picture below). The pin-out for the parallel port are shown in the table below.

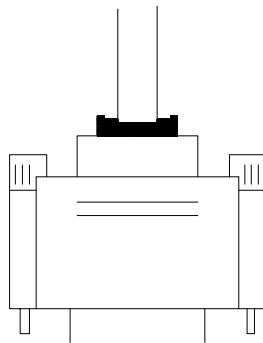
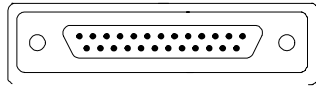

Signal	Pin
-Strobe	1
Data 0	2
Data 1	3
Data 2	4
Data 3	5
Data 4	6
Data 5	7
Data 6	8
Data 7	9
-Ack	10
Busy	11
Paper Empty	12
+Select	13
-Auto FDXT	14
-Error	15
-Init	16
-SLCTN	17
Ground	18
Ground	19
Ground	20
Ground	21
Ground	22
Ground	23
Ground	24
Ground	25

1.6 CPU Installation

1.6.1 CPU Processor

CAUTION !!!

The M6TCF desktop board supports processors that have a 19.3 A maximum current draw (2V core), or a 22.0A maximum current draw (1.6V core). Using a processor not in compliance with these guidelines can damage the processor's, the board, and the power supply. See the processor's data sheet for current usage requirements.

CAUTION !!!

Before installing or removing the processor, make sure that AC power has been removed by unplugging the power cord from the computer (the standby power indicator LED should not be lit). Failure to do so could damage the processor and the board.

NOTE

66MHz host bus frequency processors are not supported in this product. A hardware lockout is provided so that if such a processor is installed, the M6TCF will not power-up.

The M6TCF desktop board supports either a single Pentium®!!! processor at host bus frequencies of 100 or 133MHz, or a single Pentium®II processor at a host bus frequency of 100 MHz. Host bus frequencies for all processors are automatically selected.

The M6TCF board supports up to 512KB L2 cache. All supported onboard memory can be cached up to the cachability limit of the processor. See the processor's data sheet for cachability limits.

The M6TCF board supports the 242-contact slot type processors listed in Table 1. The processor must be secured by a retention mechanism attached to the board.

Table 1. Supported Processors

Processor Type	Processor Designation (MHz)	Host Bus Frequency(MHz)	L2 Cache Size (KB)
Pentium®!!! processor	450,500,550, and 600	100	512
	550E,600E,650, and 700	100	256

	533B and 600B	133	512
	533EB,600EB,667,and 733	133	256
Pentium ®II processor	350,400,and 450	100	512

1.6.2 CPU Installation Procedure

Motherboard

The M6TCF motherboard provides one Single Edge Contact (SEC) slot. This slot allows you to install a Pentium® II /Pentium®!!! serial slot CPU.

Before you use:

Please look on your motherboard and locate the CPU fan and CPU fan power supply. Please verify that this fan is directly used to cool the CPU and its heat sink, as well as to cool the motherboard and circulate the air.

WARNING : If air circulation is insufficient, the CPU will overheat, which may damage the CPU, CPU slot, and the motherboard.

Please inspect your motherboard to see if it has the Pentium® II/Pentium®!!! CPU retention kit components. (ATTENTION: The CPU installation component color and shape may vary slightly based on kits coming from different suppliers.)

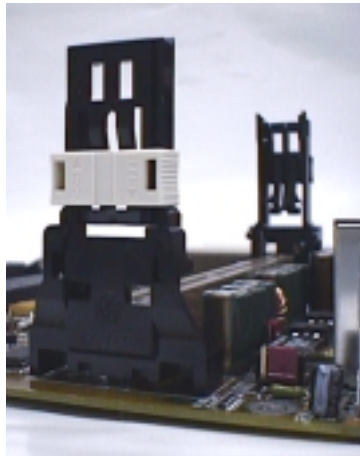

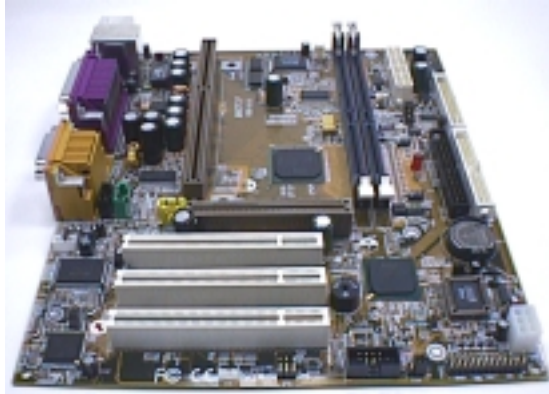
M6TCF CPU Special Installation and Setup :**Install Pentium® II / Pentium ®!!!/ Celeron :****1 · Installing the Heat Sink Support Frame :**

The Heat Sink Support Base can only be inserted one-way. Please match the leg sizes on the Heat Sink Support Base to the holes on the motherboard. Please insert the screws from the bottom of the motherboard and tighten into the rounded screw covers

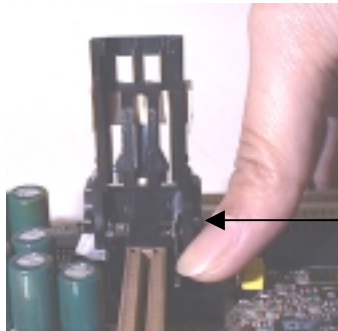

Lock in

2 · Installing the CPU Heat sink :

Take the smooth side of the Heat Sink and bind it closely together with the CPU. Next, at the ends of the Heat Sink, clip the CPU together with the Heat Sink. Please verify that there is no space between the Heat Sink and CPU unit. **WARNING:** If there is any space between the CPU and Heat Sink, the CPU will over-heat severely and may be damaged.

Attach the metal clips at ends of the CPU unit

Push the clips on the Heat Sink and CPU unit to tightly bind them together. The arrows mark the location.

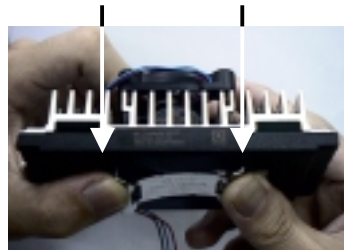
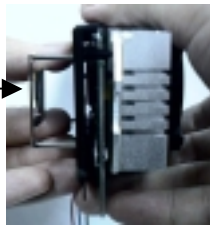

3 · Insert the CPU into the SEC Solt :

- (1) First, press the CPU unit into the Frame until it fits snugly into the notch holes. Then, clip the Heat Sink and CPU together with the Heat Sink Support Frame.

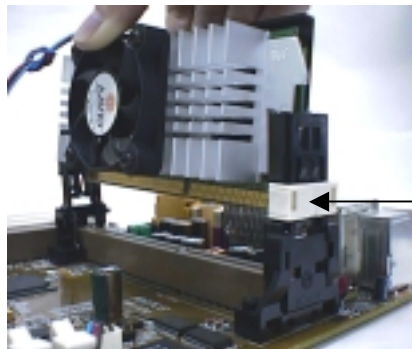

The correct direction to insert the Heat Sink and CPU into the Heat Sink Support Frame should allow you to easily insert them.

- (2) Pushing the CPU unit into the frame, wait until the CPU unit is firmly in position before securing. The notches are pushed out. They will fit tightly into the Heat Sink Frame Notch holes.

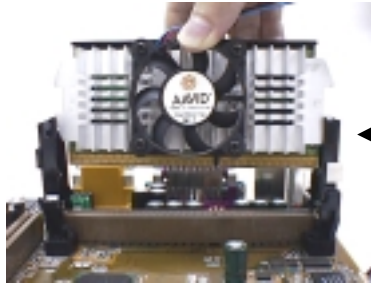

The notches on the CPU unit are pushed out to fit into the notch holes.

- (3) Firmly secure the Heat Sink by attaching the Heat Sink Frame TOP-Bar. Please verify that the Heat Sink and CPU are tightly pressed together. Please check that the entire Frame, Heat Sink, and CPU unit are tightly installed and that there is no possible movement or looseness in the assembly.



1.7 Jumper Settings

The jumper a two or more pins which may be covered by a plastic jumper cap, allowing you to select different system options.

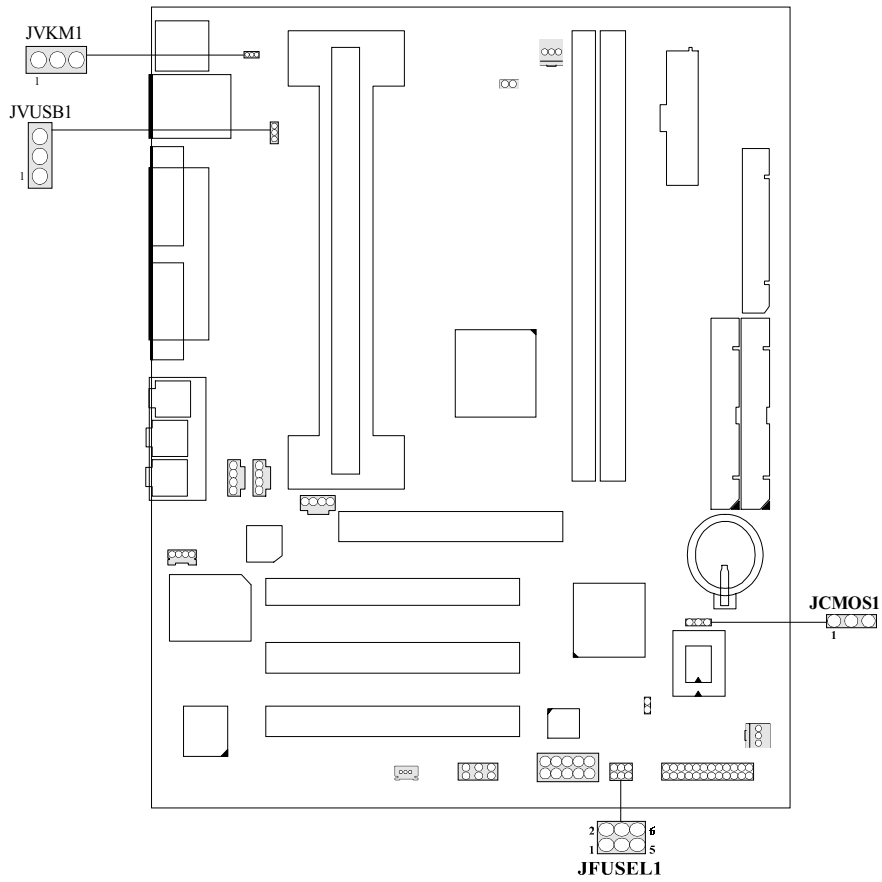

1.7.1 USB Location Selection (JFUSEL1)

Pin No.	Signal Name
1-3, 2-4 Closed	Front USB Connector Selected
3-5, 4-6 Closed	Rear USB Connector Selected

Note: The top Layer USB Port of USB/LAN connector(rear USB) and the front USB can be selected only one work at the same time.

1.7.2 CMOS Function Selection (JCMOS1)

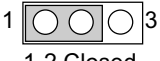
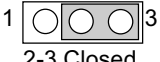
	Assignment
 1-2 Closed	Normal Operation (default)
 2-3 Closed	Plug out the power cable before clear CMOS Data

1.7.3 Mouse and Keyboard Power source Selection (JVKM1)

Pin No.	Signal Name
1-2	Stand by Voltage +5V
2-3	+5V

1.7.4 USB Power Source Selection (JVUSB1)

Pin No.	Signal Name
2-3	Stand by Voltage +5V
1-2	+5V

1.8 RIMM Installation

1.8.1 System Memory

CAUTION !!!

Incorrect insertion of RIMM modules or continuity RIMM modules in the RIMM connectors can damage the M6TCF board.

CAUTION !!!

Before installing or removing RIMM modules, make sure that AC power has been removed by unplugging the power cord from the computer (the standby power indicator LED1 should not be lit). Failure to do so could damage the memory and the board.

RDRAM Terminology

The M6TCF desktop board uses RDRAM technology. For clarity, some RDRAM terms and definitions are included in the list below.

- The terms Direct Rambus and Direct RDRAM are simplified to Rambus and RDRAM.
- The Rambus Memory System includes the Memory Controller, which in turn includes the Rambus interface, the Rambus Channel, and the DRAMs with the Rambus interface.
- The Rambus Memory Module for desktop systems is referred to as the RIMM module. The REMM connector supports a RIMM module.
- The RIMM module and RIMM connector use a form factor similar to the DIMM module and connector. They do not, however, work interchangeably.

Memory Features

The 82820 Memory Controller Hub (MCH) integrates a single Rambus channel as an electrically pipelined serial bus (16 data bits in width) with uniform impedance of 28 ohms and single ended termination. This Rambus channel is capable of providing a processor-to-memory bandwidth up to 1.6GB/sec.

The board supports the following memory features:

- Up to two 2.5V, 168-pin, RIMM modules.
- Single-or double-sided RIMM module configurations.
- Serial Presence Detect (SPD) memory only.
- Non-ECC memory with 16-bit components (128 Mbit technology).
- ECC memory with 18-bit components (144 Mbit technology).
- 512 MB maximum onboard capacity using 128/144 Mbit technology.

Continuity RIMM Module

All RIMM connectors must be populated to achieve continuity for termination at the Rambus interface. Continuity RIMMs (or “pass-through” modules) must be installed in any unused RIMM connectors.

RDRAM Memory Configuration**CAUTION !!!**

the installed RIMM modules. If the total number of The board supports combinations of no more than 32 RDRAM components across RDRAM components installed in RIMM connectors exceeds 32, the computer will not boot.

Table 1 gives examples of RDRAM component-counts for various RIMM modules. Component counts can be identified on the RIMM label.

Table 1. Typical RIMM Module Configurations

Rambus Technology	4 RDRAM components per RIMM	6 RDRAM components per RIMM	8 RDRAM components per RIMM	12 RDRAM components per RIMM	16 RDRAM components per RIMM
128/144 Mbit	64MB	96MB	128MB	192MB	256MB

NOTE

To obtain best memory bus loading characteristics, RIMM modules should be installed in Bank 0 first and then in Bank 1. (Bank 0 is closest to the processor.) A Continuity RIMM module must be installed in Bank 1 if unused.

Memory Bus Frequencies

The BIOS automatically selects the memory bus frequency from the Serial Presence Detect (SPD) information in the RIMM module. The M6TCF platform supports only Serial Presence Detect (SPD) memory. Serial Presence Detect (SPD) information is required to properly configure the Rambus interface. Table 1 describes the memory frequencies supported with standard configurations of the board. The BIOS configures the Rambus interface to the speed of the slowest RIMM module installed.

Table 2. Memory Bus Frequency with DRCG (Rambus Clock Generator)

	PC600	PC800
Host Bus frequency: 100 MHz	300 MHz	400 MHz
Host Bus frequency: 133 MHz	----	400 MHz

ECC Memory

ECC memory detects multiple-bit errors and corrects single-bit errors. When ECC memory is installed, the BIOS will support both ECC and non-ECC mode. The BIOS automatically detects if ECC memory is installed and provides the Setup option for selecting ECC mode. ECC mode must be enabled in the Setup program; the default setting is disabled. If any non-ECC memory is installed, ECC operation is not available.

Table 3. Memory Error Detection Mode Established in Setup Program

Memory Type	ECC Disabled	ECC Enabled
Non-ECC RIMM	No error detection	N/A
ECC RIMM	No error detection	Single-bit error correction, multiple-bit error detection.

NOTE

Whenever ECC mode is selected in Setup, some performance loss may occur.

1.8.2 RIMM

RIMM I/O frequency : 300 and 400 MHZ
RIMM TYPE : 64 MB/128 MB/256 MB

RIMM1	RIMM2	TOTAL Memory size (MB)
64	CM	64
128	CM	128
64	64	128
128	64	192
128	128	256
256	CM	256
256	64	320
256	128	384
256	256	512

CM:Continuity Module

Note : When the red LED LED1 is lighting, do not install any RIMM or continuity module. Please ensure all the RIMMs or continuity modules are installed properly before the ATX power connector is plugged.

1.9 Audio Subsystem

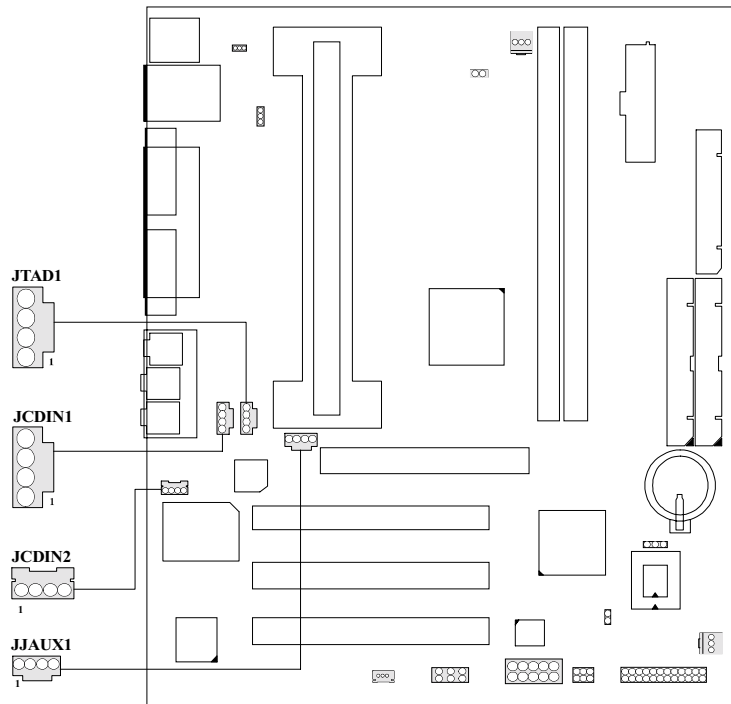

1.9.1 ATAPI Style CD ROM Audio In Header (JCDIN1)

Pin No. of J5	Assignment
1	Left Channel Input
2	GND
3	GND
4	Right Channel Input

1.9.2 Legacy –style ,2mm CD ROM Audio-In Header (JCDIN2)

Pin No. of J4	Assignment
1	Left Channel Input
2	GND
3	Right Channel Input
4	GND

1.9.3 Telephony ATAPI style Header(JTAD1)

Pin No.	TAD
1	MONO_out
2	GND
3	GND
4	MONO_in

1.9.4 Auxiliary ATAPI style Audio in Header (JJAUX1)

Pin No.	TAD
1	Left Channel Aux-in
2	GND
3	GND
4	Right Channel Aux in

2. BIOS Setup

Introduction

In a computers, the system parameters (such as amount of memory, type of disk drives and video displays, and many other elements) are stored in CMOS RAM. Unlike the DRAM (dynamic random access memory) that is used for standard system memory, CMOS RAM requires very little power. When the computer is turned off, a back-up battery provides power to CMOS RAM, which retains the system parameters. Every time the computer is powered-on, the computer is configured with the values stored in CMOS RAM by the system BIOS, which gains control when the computer is powered on.

The system parameters are configured by a system BIOS Setup. Historically, BIOS Setup have been character-based, required keyboard input, and have had user interfaces that were not very intuitive.

2.1 Main

Choose Standard CMOS Setup from the AMI BIOS Setup main menu. All Standard Setup options are described in this section. The Standard CMOS Setup screen is shown below.

!! WARNING!! The information about BIOS defaults on manual (Figure 1-14) is just for reference, please refer to the BIOS installed on board, for update information.

■ Figure 1. Main

AMIBIOS EASY SETUP UTILITIES Ver. 1.17 (c)1998 American Megatrends, Inc. All Rights Reserved	
Main	Advanced Security Exit
Systeme Date	Wed Nov 24 1999
System Time	11:21:30
Floppy Drive A	1.44 MB 3 ½
Floppy Drive B	Not Installed
Primary IDE Master	Auto
Primary IDE Slave	Auto
Secondary IDE Master	Auto
Secondary IDE Slave	Auto
Auto-Detect Hard Disks	[Enter]
Boot Sector Virus Protection	Disabled

◀◀ Setup Help ▶▶

Month: Jan - Dec
Day: 01 - 31
Year: 1901 - 2099

↑ Previous Item
↓ Next Item
← Select Menu

Esc:Exit	Enter:Select	F5:Setup Defaults	F6:Original Values	F10:Save & Exit
----------	--------------	-------------------	--------------------	-----------------

System Date/Time

Select Standard CMOS Setup from the AMIBIOS Setup main menu. Highlight Date or Time using the arrow keys. Enter new values through the keyboard. Press the <Tab> key or the arrow keys to move between fields. The date must be entered in MM/DD/YYYY format. The time is entered in HH:MM:SS format. The time is in 24-hour format, also. For example, 5:30 a.m. appears as 05:30:00, and 5:30 p.m. as 17:30:00.

Press <PgUp> or <PgDn> after you have selected an option to display the complete list of valid setting in the bottom section of the screen. For example when the cursor is in the Date field, the option for month , day, and year display, as seen in the screen above.

Floppy Drive A: and B:

Move the cursor to these fields via ↑ and ↓ and select the floppy type. The settings are 360KB 5¼, 1.2 MB 5¼, 720 KB 3½, 1.44 MB 3½, 2.88 MB 3½, or Not Installed.

Primary / Secondary IDE Master/Slave

Select one of these hard disk drives to configure the hard disk drive named in the option. Press <Enter> to autodetect. The settings for each of these drives are:

Setting	Description
1 46 Predefined types	If you are configuring an old MFM drive and you know the drive type, select the correct drive type between 1-46.
USER: Enter parameters manually	If you are installing an old MFM drive and you do not know the drive type or the drive parameters do not match the drive parameters for types 1 46, enter the correct hard disk drive parameters.

Setting	Description
AUTO: Set parameters automatically on each boot	<p>Select Auto to let AMIBIOS determine the parameters. Click on OK when AMIBIOS displays the drive parameters. You can also change these parameters if you do not think AMIBIOS detected the drive parameters correctly or if you want to enable an enhanced IDE feature. You can modify these parameters as follows:</p> <p>Select <i>LBA/Large Mode</i>. Select <i>On</i> if the drive has a capacity greater than 540 MB.</p> <p>Select <i>Block Mode</i>. Select <i>On</i> to allow block mode data transfers.</p> <p>Select <i>32-Bit Mode</i>. Select <i>On</i> to allow 32-bit data transfers.</p> <p>Select the <i>PIO Mode</i>. It is best to select <i>Auto</i> to allow AMIBIOS to determine the PIO mode. If you select a PIO mode that is not supported by the IDE drive, the drive will not work properly. If you are absolutely certain that you know the drive PIO mode. Select PIO mode 0 – 5, as appropriate.</p>
CD – ROM Use for ATAPI CDROM drives	Select CDROM if configuring an ATAPI drive. AMIBIOS displays the drive parameters
ARMD: Use for LS120, MO, Iomega Zip drives	Select this setting if you are configuring an LS120, MO (Magneto – optical), or Iomega Zip drive.

Auto-Detect Hard Disks

Boot Sector Virus Protection

This option is near the bottom of the Standard Setup screen. The settings are *Enabled* or *Disabled*. Choose *Enabled* to enable boot sector protection. AMIBIOS displays a warning when any program (or virus) issues a Disk Format command or attempts to write to the boot sector of the hard disk drive. If enabled, the following appears when a write is attempted to the boot sector. You may have to type *N* several times to prevent the boot sector write.

```
Boot Sector Write !!!  
Possible VIRUS: Continue (Y/N)? _
```

The following appears after any attempt to format any cylinder, head, or sector of any hard disk drive via the BIOS INT 13 Hard Disk Drive Service:

```
Format !!!  
Possible VIRUS: Continue (Y/N)? _
```

2.2 Advanced CMOS Setup

The items in Standard CMOS Setup Menu are divided into 10 categories. Each category includes no, one or more than one setup items. Use the arrow keys to highlight the item and then use the <PgUp> or <PgDn> keys to select the value you want in each item.

■ Figure 2. Advanced CMOS Setup

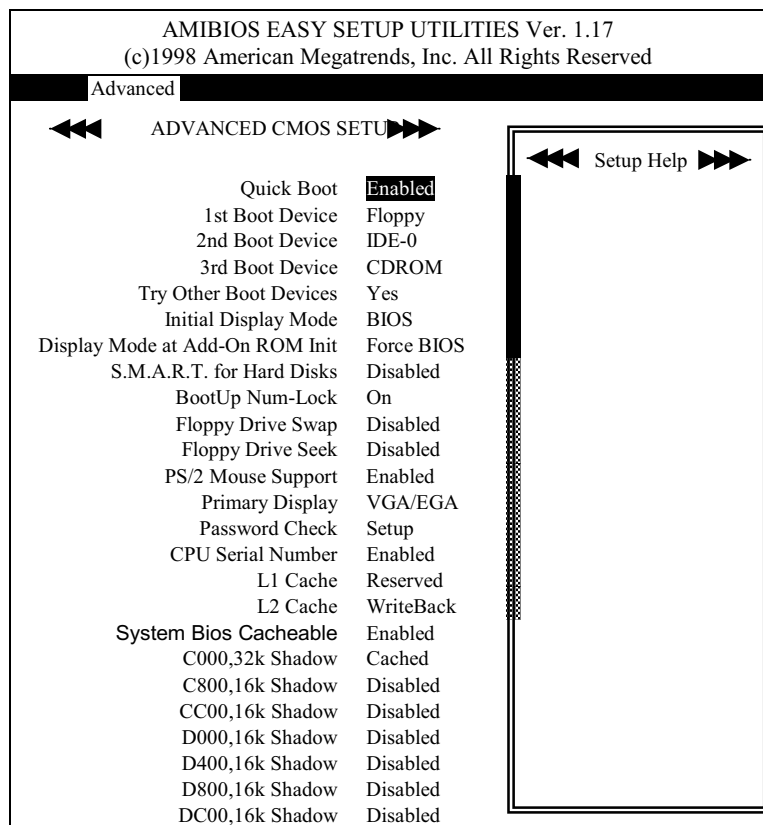

Esc:Back Enter:Select ↑ ↓:Select Item F5:Setup Defaults F6:Original Values

Quick Boot

Set this option to *Enabled* to instruct AMIBIOS to boot quickly when the computer is powered on. This option replaces the old **Above 1 MB Memory Test** Advanced Setup option. The settings are:

Setting	Description
Disabled	AMIBIOS test all system memory. AMIBIOS waits up to 40 seconds for a READY signal from the IDE hard disk drive. AMIBIOS waits for .5 seconds after sending a RESET signal to the IDE drive to allow the IDE drive time to get ready again. AMIBIOS checks for a key press and runs AMIBIOS Setup if the key been pressed.
Enabled	AMIBIOS does not test system memory above 1 MB. AMIBIOS does not wait up to 40 seconds for a READY signal from the IDE hard disk drive. If a READY signal is not received immediately from the IDE drive, AMIBIOS does not configure that drive. AMIBIOS does not wait for .5 seconds after sending a RESET signal to the IDE drive to allow the IDE drive time to get ready again. You cannot run AMIBIOS Setup at system boot, because there is no delay for the Hit to run Setup message.

1st Boot Device

This option sets the type of device for the first boot drives that the AMIBIOS attempts to boot from after AMIBIOS POST completes. The settings are *Disabled*, *Floppy*, *IDE-0*, *IDE-1*, *IDE-2*, *IDE-3*, *LS-120/ZIP*, *ATAPI ZIP*, *CDROM*, *SCSI* or *NETWORK*.

The Optimal and Fail-Safe default settings are Floppy.

2nd Boot Device

This option sets the type of device for the second boot drives that the AMIBIOS attempts to boot from after AMIBIOS POST completes. The settings are *Disabled*, *Floppy*, *IDE-0*, *IDE-1*, *IDE-2*, *IDE-3*, *LS-120/ZIP*, *ATAPI ZIP*, *CDROM*, *SCSI* or *NETWORK*.

The Optimal and Fail-Safe default settings are IDE-0.

3rd Boot Device

This option sets the type of device for the third boot drives that the AMIBIOS attempts to boot from after AMIBIOS POST completes. The settings are *Disabled*, *Floppy*, *IDE-0*, *IDE-1*, *IDE-2*, *IDE-3*, *LS-120/ZIP*, *ATAPI ZIP*, *CDROM*, *SCSI* or *NETWORK*.

The Optimal and Fail-Safe default settings are CDROM.

Try Other Boot Devices

Set this option to Yes to instruct AMIBIOS to attempt to boot from any other drive in the system if it cannot find a boot drive among the drives specified in the **1st Boot Device**, **2nd Boot Device**, **3rd Boot Device**, and **4th Boot Device** options. The settings are *Yes* or *No*.

The Optimal and Fail-Safe default settings are Yes.

Initial Display Mode

The Optimal and Fail-Safe default settings are BIOS.

Display Mode at Add-On ROM Init

The Optimal and Fail-Safe default settings are Force BIOS.

S.M.A.R.T. for Hard Disks

Set this option to Enabled to permit AMIBIOS to use the SMART (Self Monitoring Analysis and Reporting Technology) protocol for reporting server system information over a network. The settings are Enabled or Disabled.

The Optimal and Fail-Safe default settings are Disabled.

BootUp Num-Lock

Set this option to Off to turn the Num Lock key off when the computer is booted so you can use the arrow keys on both the numeric keypad and the keyboard. The settings are *On* or *Off*.

The Optimal and Fail-Safe default settings are On.

Floppy Drive Swap

Set this option to *Enabled* to permit drives A: and B: to be swapped. The settings are *Enabled* or *Disabled*.

The Optimal and Fail-Safe default settings are Disabled.

Floppy Drive Seek

Set this option to *Enabled* to specify that floppy drive A: will perform a Seek operation at system boot. The settings are *Disabled* or *Enabled*.

The Optimal and Fail-Safe default settings are Disabled.

PS/2 Mouse Support

Set this option to *Enabled* to enable AMIBIOS support for a PS/2-type mouse. Pins 2-3 of the PS/2 Mouse Selector jumper on the motherboard must be shorted together to enable PS/2 mouse support. The settings are *Enabled* or *Disabled*.

The Optimal and Fail-Safe default settings are Enabled.

Primary Display

This option configures the type of monitor attached to the computer. The settings are *Absent*, *VGA/EGA*, *CGA40x25*, *CGA80x25*, or *Mono*.

The Optimal and Fail-Safe default settings are VGA/EGA.

Password Check

This option enables password checking every time the system boots or when you run AMIBIOS Setup. If *Always* is chosen, a user password prompt appears every time the computer is turned on. If *Setup* is chosen, the password prompt appears if AMIBIOS is executed. See the Advanced Setup chapter for instructions on changing a password.

The Optimal and Fail-Safe default settings are Setup.

CPU Serial Number

The Optimal and Fail-Safe default settings are Enabled.

L1/L2 Cache

This option sets the type of caching algorithm used by the L1 internal cache memory on the CPU and the L2 secondary cache memory. The settings are WriteBack, WriteThru, or Disabled.

System BIOS Cacheable

Determines whether system BIOS will be copied to RAM for faster execution.

Enabled	Optional ROM is enabled.
Disabled (default)	Optional ROM is disabled.

C0000 - DFFFF Cacheable

Determines whether the optional ROM will be copied to RAM for faster execution.

Enabled	Optional ROM is shadowed.
Disabled (default)	Optional ROM is not shadowed.

Note : For C0000 - DFFFF option - ROM on PCI BIOS, BIOS will automatically enable the shadow RAM. User does not have to select the item.

2.3 Advanced Chipset Setup

Choose Advanced Chipset Setup from the AMIBIOS Setup main menu. All Chipset Setup options are described below.

■ Figure 3. Advanced Chipset Setup

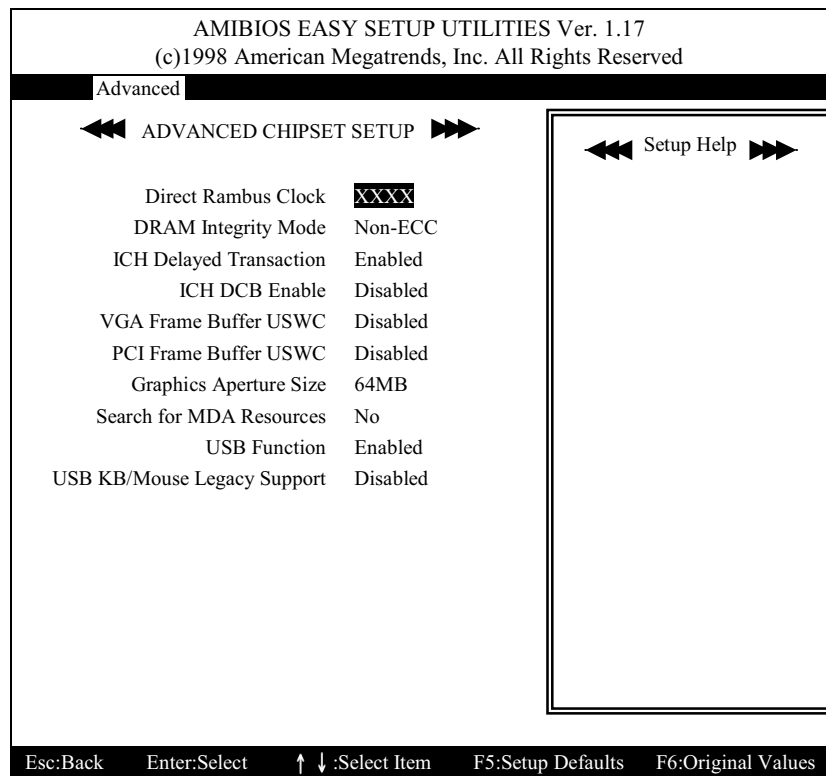

Direct Rambus Clock

The Optimal and Fail-Safe default settings are 300Mhz.

DRAM Intergirity Mode

This option sets the type of system memory checking. The settings are:

Setting	Description
Non ECC	No error checking or error reporting is done.
ECC Only	Multibit errors are detected and reported as parity errors. Single-bit errors are corrected by the chipset. Corrected bits of data from memory are not written back to DRAM system memory. If <i>Level I</i> is selected, the J25 External SMI software jumper on the Series 745 board is disabled.
ECC	Multibit errors are detected and reported as parity errors Single-bit errors are corrected by the chipset and are written back to DRAM system memory. If a soft (correctable) memory error occurs, writing the fixed data back to DRAM system memory will resolve the problem Most DRAM errors are soft errors. If a hard (uncorrectable) error occurs, writing the fixed data back to DRAM system memory does not solve the problem. In this case, the second time the error occurs in the same location, a Parity Error is reported, indicating an uncorrectable error. If <i>ECCI</i> is selected, AMIBIOS automatically enables the System Management Interface (SMI) is enabled. If you do not want to enable power management, set the Power Management/APM option to <i>Disabled</i> and set all Power Management Setup timeout options to <i>Disabled</i> . To enable power management, set Power Management/APM to <i>Enabled</i> and set the power management timeout options as desired.

The Optimal and Fail-Safe default settings are Non-ECC.

ICH Delayed Transaction

The chipset has an embedded 32-bit posted write buffer to support delay transactions cycles. Select *Enabled* to support compliance with PCI specification version 2.1.

The Choices: Enabled (default), Disabled

ICH DCB Enable

The Optimal and Fail-Safe default settings are Disabled.

VGA Frame Buffer USWC

Set this option to *Enabled* to enable the VGA video frame buffer using USWC (Uncacheable, Speculatable, Write-Combined) memory. The settings are *Enabled* or *Disabled*. Older ISA VGA card drivers may not behave correctly if this option is not set to *Disabled*.

The Optimal and Fail-Safe default settings are Disabled.

PCI Frame Buffer USWC

Set this option to *Enabled* to enable the USWC memory attribute and improve video performance when a PCI video adapter is installed. However, VGA card drivers may not behave correctly when this option is set to *Enabled*. The settings are *Disabled* or *Enabled*.

The Optimal and Fail-Safe default settings are Disabled.

Graphics Apertures Size

This option specifies the amount of system memory that can be used by the Accelerated Graphics Port (AGP). The settings are *4MB*, *8MB*, *16MB*, *32MB*, *64MB*, *128MB*, or *256MB*.

The Optimal and Fail-Safe default settings are 64MB.

Search for MDA Resources

The Optimal and Fail-Safe default settings are No.

USB Function

Set this option to *Enabled* to enable the system BIOS USB (Universal Serial Bus) functions. The settings are *Enabled* or *Disabled*.

The Optimal and Fail-Safe default settings are Enabled.

USB KB/Mouse Legacy Support

Set this option to *Enabled* to enable USB support for legacy keyboards and mice. The settings are *Disabled*, *Keyboard* or *keyb+Mouse*.

The Optimal and Fail-Safe default settings are Disabled.

2.4 Power Management Setup

Choose Power Management Setup from the AMIBIOS Setup main menu. All Power Management Setup options are described in this section.

■ Figure 4. Power Management Setup

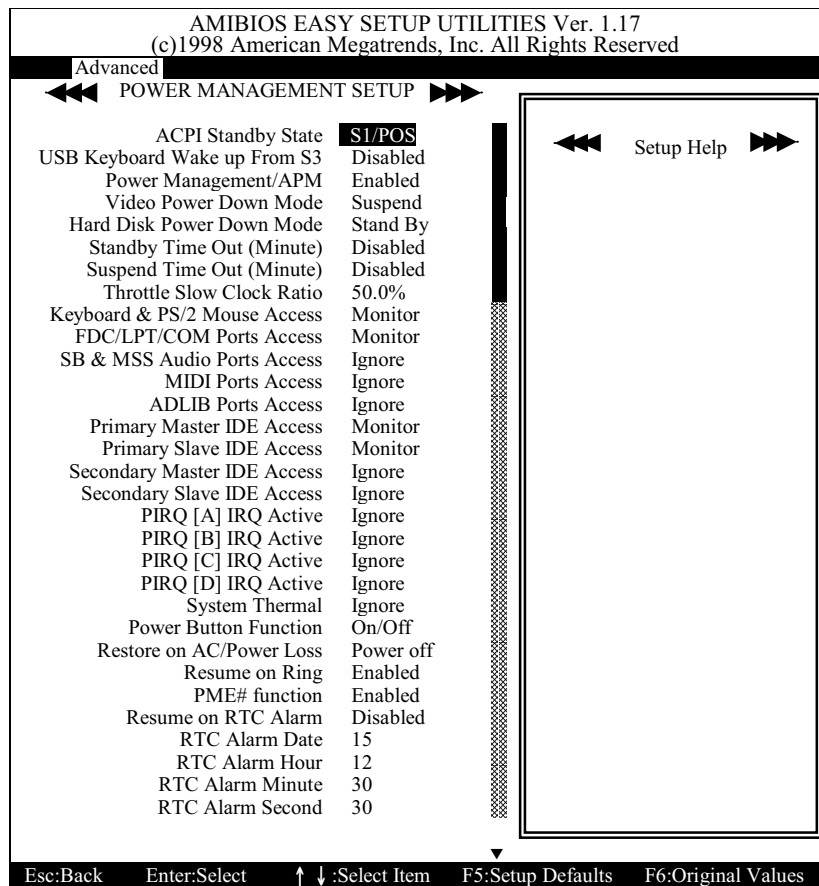

ACPI Stand by state

The item allows you to select the suspend type under ACPI operating system.

S1 (POS) (default)	Power on Suspend
S3 (STR)	Suspend to RAM

USB Keyboard Wake up From S3

USB Keyboard can wake up system from S3 state enabled.

Power Management/APM

Set this option to *Enabled* to enable the chipset power management and APM (Advanced Power Management) features. The settings are *Enabled* or *Disabled*.

The Optimal and Fail-Safe default settings are Enabled.

Video Power Down Mode

This option specifies the power state that the video subsystem enters when AMIBIOS places it in a power saving state after the specified period of display inactivity has expired. The settings are *Standby*, *Suspend* or *Disabled*.

The Optimal and Fail-Safe default settings are Suspend.

Hard Disk Power Down Mode

This option specifies the power conserving state that the hard disk drive enters after the specified period of hard drive inactivity has expired. The settings are *Disabled*, *Stand By*, or *Suspend*.

The Optimal and Fail-Safe default settings are Stand By.

Standby Timer Out (Minute)

This option specifies the length of a period of system inactivity while in Full power on state. When this length of time expires, the computer enters Standby power state. The settings are *Disabled*, *1*, *2*, *4*, *8*, *10*, *20*, *30*, *40*, *50*, *60*.

The Optimal and Fail-Safe default settings are Disabled.

Suspend Time Out (Minute)

This option specifies the length of a period of system inactivity while in Standby state. When this length of time expires, the computer enters Suspend power state. The settings are *Disabled*, *1*, *2*, *4*, *8*, *10*, *20*, *30*, *40*, *50*, *60*.

The Optimal and Fail-Safe default settings are Disabled.

Throttle Slow Clock Ratio

This option specifies the speed at which the system clock runs in the Standby Mode power saving state. The settings are expressed as a percentage between the normal CPU clock speed and the CPU clock speed when the computer is in the power-conserving state. The settings are 87.5%, 75.0%, 62.5%, 50.0%, 37.5%, 25.0%, or 12.5%.

The Optimal and Fail-Safe default settings are 50.0%.

Keyboard & PS/2 Mouse Access

The Optimal and Fail-Safe default settings are Monitor.

FDC/LPT/COM Ports Access

The Optimal and Fail-Safe default settings are Monitor.

SB & MSS Audio Ports Access

The Optimal and Fail-Safe default settings are Ignore.

MIDI Ports Access

The Optimal and Fail-Safe default settings are Ignore.

ADLIB Ports Access

The Optimal and Fail-Safe default settings are Ignore.

Primary / Secondary Master IDE Access

The Optimal and Fail-Safe default settings are Monitor.

Primary / Secondary Slave IDE Access

The Optimal and Fail-Safe default settings are Ignore.

PIRQ[A-D] IRQ Active

The Optimal and Fail-Safe default settings are Ignore.

System Thermal

The Optimal and Fail-Safe default settings are Ignore.

Power Button Function

This option specifies how the power button mounted externally on the computer chassis is used. The settings are:

Setting	Description
On/Off	Pushing the power button turns the computer on or off.
suspend	Pushing the power button places the computer in Suspend mode or Full On power mode.

The Optimal and Fail-Safe default settings are On/Off.

Restore on AC/Power Loss

The Optimal and Fail-Safe default settings are Last State.

Resume on Ring

An input signal on the serial Ring Indicator (RI) line (in other words, an incoming call on the modem) awakens the system from a soft off state..

The Optimal and Fail-Safe default settings are Disabled.

PME # Function enable

A input signal on PCI PME# awake us the system from a soft off state.

Resume on RTC Alarm

The Optimal and Fail-Safe default settings are Disabled.

RTC Alarm Date

The Optimal and Fail-Safe default settings are Disabled.

2.5 Plug and Play Setup

Choose PCI/PnP Setup from the AMIBIOS Setup main menu. All PCI/PnP Setup options are described in this section.

■ Figure 5. Plug and Play Setup

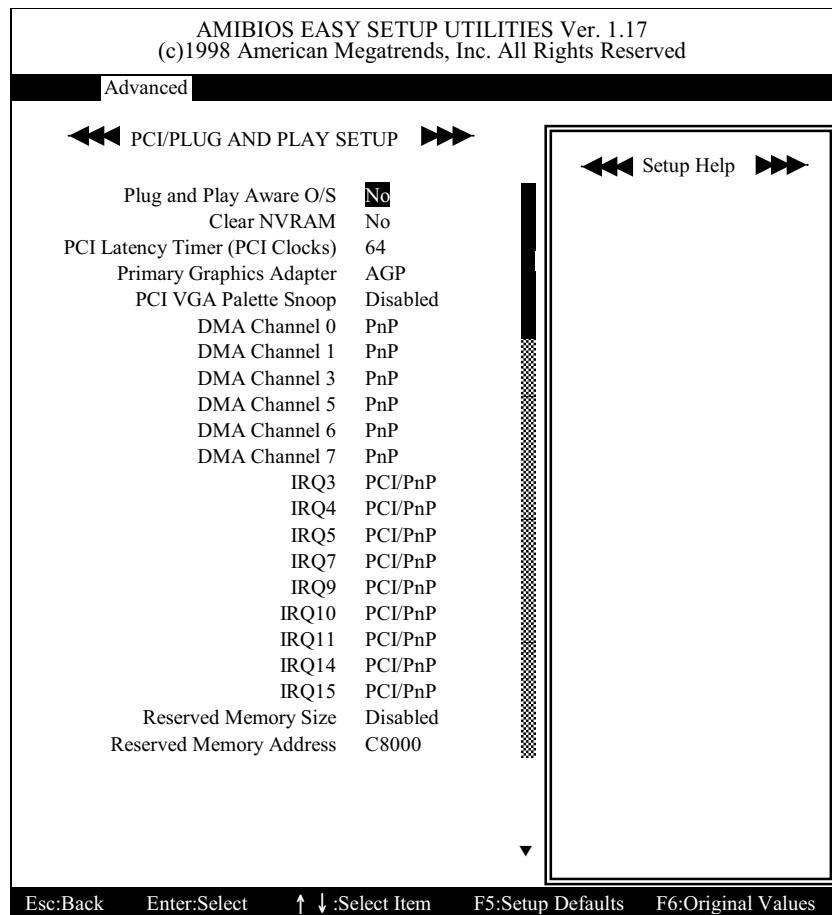

Plug and Play Aware O/S

Set this option to *Yes* if the operating system in this computer follows the Plug and Play specification. Windows 95 is PnP-aware. The settings are *Yes* or *No*.

The Optimal and Fail-Safe default settings are No.

Clear NVRAM

The Optimal and Fail-Safe default settings are No.

PCI Latency Timer (PCI Clocks)

These options specify the latency timings (in PCI clocks) for PCI devices installed in the PCI expansion slot. The settings are *32, 64, 96, 128, 160, 192, 224, or 248*.

The Optimal and Fail-Safe default settings are 64.

Primary Graphics Adapter

The Optimal and Fail-Safe default settings are AGP.

PCI VGA Palette Snoop

When this option is set to *Enabled*, multiple VGA devices operating on different buses can handle data from the CPU on each set of palette registers on every video device. Bit 5 of the command register in the PCI device configuration space is the VGA Palette Snoop bit (0 is disabled). For example: if there are two VGA devices in the computer (one PCI and one ISA) and the VGA Palette Snoop bit is:

Setting	Description
Disabled	Data read and written by the CPU is only directed to the PCI VGA device's palette registers.
Enabled	Data read and written by the CPU is directed to the both the PCI VGA device palette registers and the ISA VGA device palette registers, and the palette registers of both devices can be identical.

This option must be set to Enabled if an ISA adapter card installed in the system uses VGA palette snooping.

The Optimal and Fail-Safe default settings are Disabled.

DMA Channel 0/1/3/5/6/7

These options allow you to specify the bus type used by each DMA channel. The settings are *PnP* or *ISA*.

The Optimal and Fail-Safe default settings are PnP.

IRQ 3/4/5/7/9/10/11/14/15

These options specify the bus that the specified IRQ line is used on. These options allow you to reserve IRQs for legacy ISA adapter cards. These options determine if AMIBIOS should remove an IRQ from the pool of available IRQs passed to devices that are configurable by the system BIOS. The available IRQ pool is determined by reading the ESCD NVRAM. If more IRQs must be removed from the pool, the end user can use these options to reserve the IRQ by assigning an *ISA* setting to it. Onboard I/O is configured by AMIBIOS. All IRQs used by onboard I/O are configured as *PCI*, *PnP*, or *PCI/PnP*. IRQ14 and 15 Will not be available if the onboard Triton 2 PCI IDE is enabled. If all IRQs are set to *ISA* and IRQ14 and 15 are allocated to the onboard PCI IDE, IRQ9 will still be available for PCI and PnP devices, because at least one IRQ must be available for PCI and PnP devices. The settings are *ISA*, *PnP*, *PCI/PnP*, or *PCI*.

The Optimal and Fail-Safe default settings are PCI/PnP.

Reserved Memory Size

This option specifies the size of the memory area reserved for legacy ISA adapter cards. The settings are *Disabled*, *16K*, *32K*, or *64K*.

The Optimal and Fail-Safe default settings are Disabled.

Reserved Memory Address

This option specifies the beginning address (in hex) of the reserved memory area. The specified ROM memory area is reserved for use by legacy ISA adapter cards. The settings are *C0000*, *C4000*, *C8000*, *CC000*, or *D0000*.

The Optimal and Fail-Safe default settings are C8000.

2.6 Peripheral Setup

Choose Peripheral Setup from the AMIBIOS Setup main menu. All Peripheral Setup options are described below.

■ Figure 6. Peripheral Setup

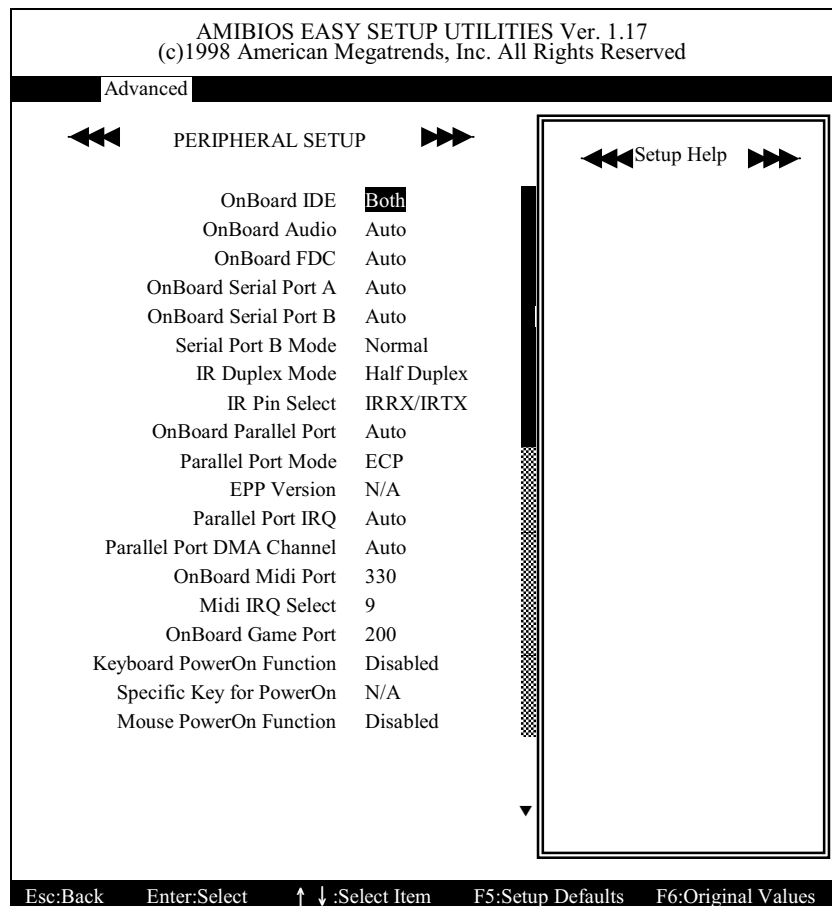

OnBoard IDE

The integrated peripheral controller contains an IDE interface with support for two IDE channels. Select Enabled to activate each channel separately.

The Choices: Enabled (default), Disabled

OnBoard Audio

If Auto set Bios will initial onboard audio chip.If there is no Onboard Audio chip Bios will initial ICH AC97 audio otherwise disable both.

OnBoard FDC

Set this option to *Enabled* to enable the floppy drive controller on the motherboard. The settings are *Auto* (*AMIBIOS automatically determines if the floppy controller should be enabled*), *Enabled*, or *Disabled*.

The Optimal and Fail-Safe default settings are Auto.

OnBoard Serial PartA

This option specifies the base I/O port address of serial port A. The settings are *Auto* (*AMIBIOS automatically determines the correct base I/O port address*), *Disabled*, *3F8h/COM1*, *2F8h/COM2*, *3E8h/COM3*, or *2E8h/COM4*.

The Optimal and Fail-Safe default settings are Auto.

OnBoard Serial PartB

This option specifies the base I/O port address of serial port B. The settings are *Auto* (*AMIBIOS automatically determines the correct base I/O port address*), *Disabled*, *3F8h/COM1*, *2F8h/COM2*, *3E8h/COM3*, or *2E8h/COM4*.

The Optimal and Fail-Safe default settings are Auto.

Serial PortB Mode

This option specifies the operating mode for serial port B. This option appears only if the **Onboard Serial Port B** option is not set to *Auto* or *Disabled*. The settings are *Normal*, *1.6uS*, *3/16 Baud* or *ASKIR*.

The Optimal and Fail-Safe default settings are Normal.

IR Duplex Mode

This option specifies the infrared transmission method. This option appears only if the Onboard Serial Port B option is not set to *Auto* or *Disabled*. The settings are *Full Duplex* or *Half Duplex*.

The Optimal and Fail-Safe default settings are Half Duplex.

IR Pin Select

The Optimal and Fail-Safe default settings are IRRX/IRTX.

OnBoard Parallel Port

This option specifies the base I/O port address for the parallel port. The settings are *Auto, Disabled, 378, 278* or *3BC*.

The Optimal and Fail-Safe default settings are Auto.

Parallel Port Mode

This option specifies the parallel port mode. The settings are:

Setting	Description
Normal	The normal parallel port mode is used.
ECP	The parallel port can be used with devices that adhere to the Enhanced Parallel Port (EPP) specification. EPP uses the existing parallel port signals to provide asymmetric bidirectional data transfer driven by the host device.
ECP	The parallel port can be used with devices that adhere to the Extended Capabilities Port (ECP) specification. ECP uses the DMA protocol to achieve data transfer rates up to 2.5 Megabits per Second. ECP provides symmetric bidirectional communication.
Bi-Dir	Data can be sent to and received from the parallel port.

The Optimal and Fail-Safe default settings are ECP.

EPP Version

This option specifies the Enhanced Parallel Port Specification version number that is used in the system. This option appears only if the **Parallel Port Mode** option is set to *EPP*. The settings are *1.7, 1.9*, and *N/A*.

There are no Optimal and Fail-Safe default settings because the default setting for the **Parallel Port Mode** option is not *EPP*. If the **Parallel Port Mode** is set to *Normal* or *ECP*, then *N/A* displays.

The Optimal and Fail-Safe default settings are N/A.

Parallel Port IRQ

This option specifies the IRQ (Interrupt Request Line) used by the parallel port.
The Optimal and Fail-Safe default settings are Auto.

Parallel Port DMA Channel

This option is only available if the setting for the **Parallel Port Mode** option is Extended or ECP. This option sets the DMA channel used by the parallel port.
The Optimal and Fail-Safe default settings are Auto.

OnBoard Midi Port

The Optimal and Fail-Safe default settings are Disabled.

Midi IRQ Select

The Optimal and Fail-Safe default settings are 5.

OnBoard Game Port

The Optimal and Fail-Safe default settings are Disabled.

Keyboard PowerOn Function

The Optimal and Fail-Safe default settings are Disabled.

Specific Key for PowerOn

The Optimal and Fail-Safe default settings are N/A.

Mouse PowerOn Function

The Optimal and Fail-Safe default settings are Disabled.

OnBoard IDE

The Optimal and Fail-Safe default settings are Both.

2.7 Hardware Monitor Setup

■ Figure 7. Hardware Monitor Setup

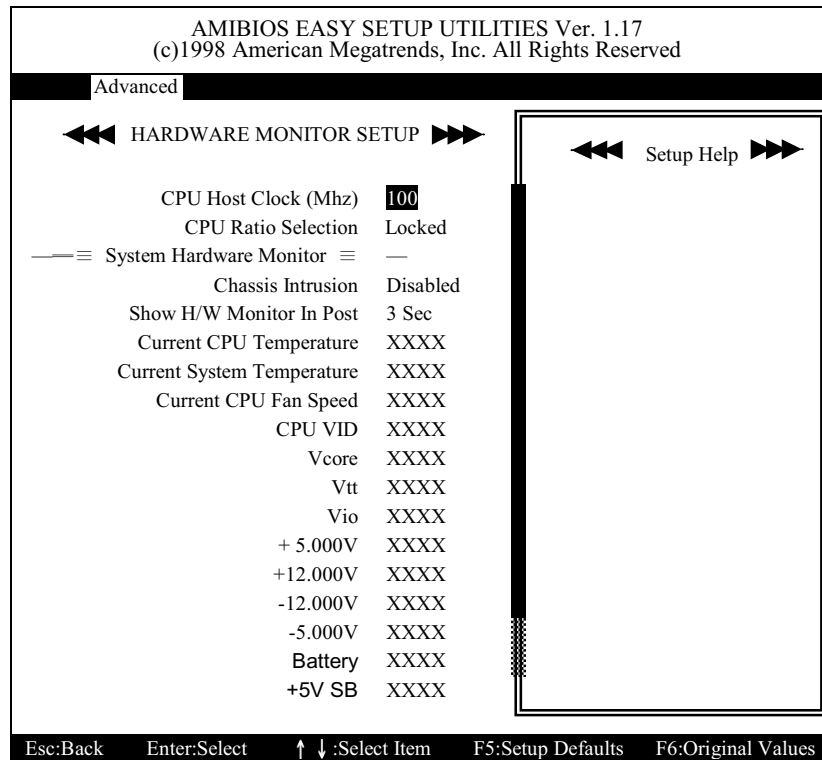

CPU Ratio Selection

The Optimal and Fail-Safe default settings are 3.0x.

CPU Host Clock (Mhz)

The Optimal and Fail-Safe default settings are 100.
The item allows you to select CPU host clock.

CPU Ratio Selection

The Optimal and Fail-Safe default setting are 2X.
The item allows you to select the ratio of CPU host clock.

Chassis Intrusion

The Optimal and Fail-Safe default settings are Disabled.

Show H/W Monitor In Post

The item allows you to select weather to show hardware Monitor in post screen.

Current CPU Temperature

This field displays the *current* CPU temperature, if your computer contains a monitoring system.

Current System Temperature

This field displays the *current* system temperature, if your computer contains a monitoring system.

Chassis Fan Speed

Detect Chassis Fan speed status automatically.

Current CPU Fan Speed

Detect CPU Fan speed status automatically.

Current CPU Vcore ±5V, ±12V, VBAT, 5VSB

Detect system's voltage status automatically.

2.8 Set Supervisor Password

■ Figure 8. Set Supervisor Password

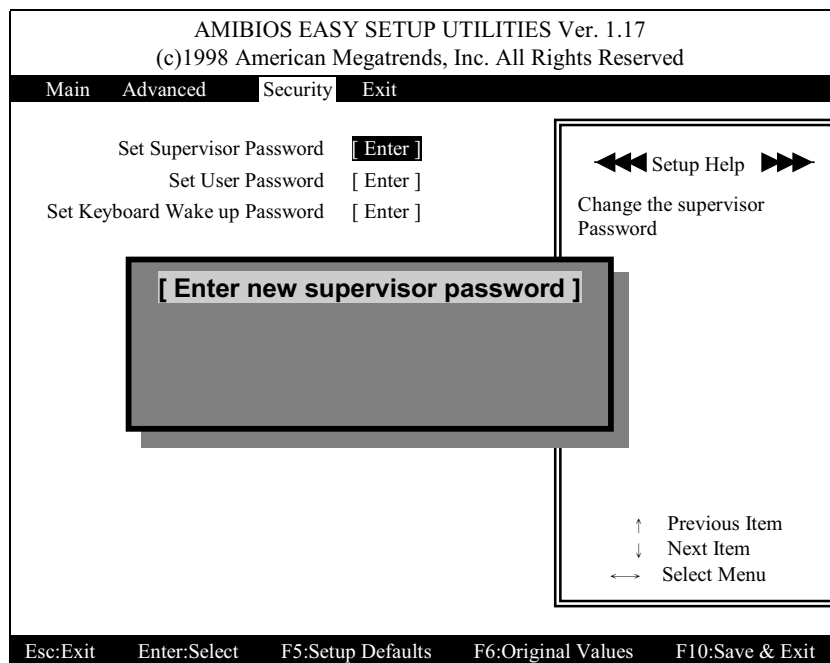

Type the password and press <Enter>. The screen does not display the characters entered. Retype the password as prompted and press <Enter>. If the password confirmation is incorrect, an error message appears. The password is stored in NVRAM after AMIBIOS completes. The next time the system boots, a password prompt appears if the Password Check option is set to Always.

2.9 Set Keyboard Wake up Password

■ Figure 9. Set Supervisor Password

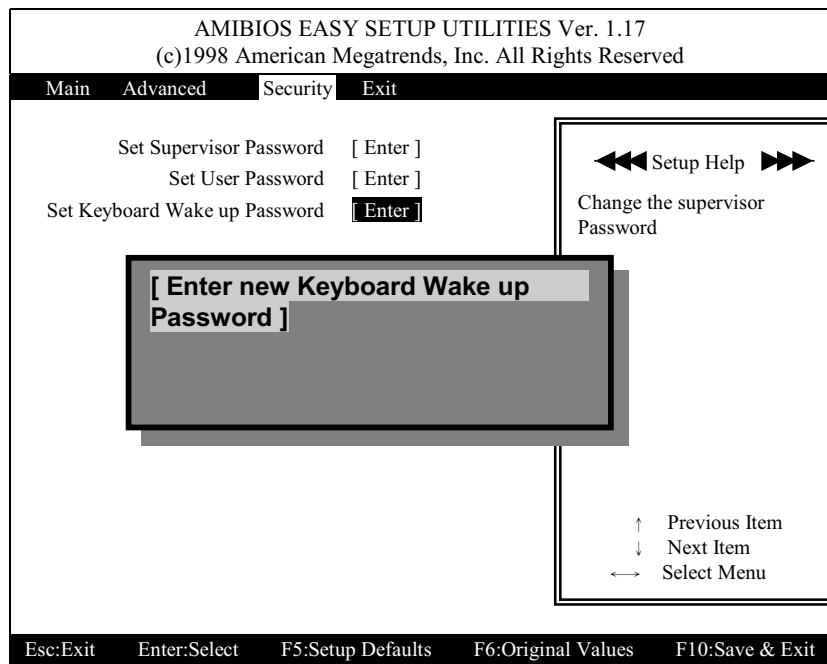

When you set specific key in keyboard power on function, then you can specify your password.

2.10 Exit Saving Changes

■ Figure 10. Exit Saving Changes

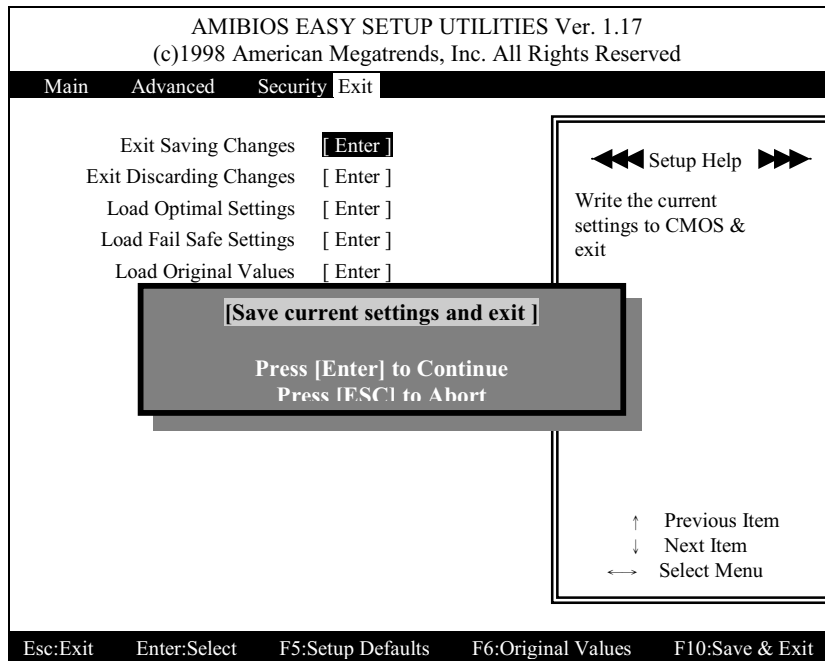

2.11 Exit Discarding Changes

■ Figure 11. Save & Exit Setup

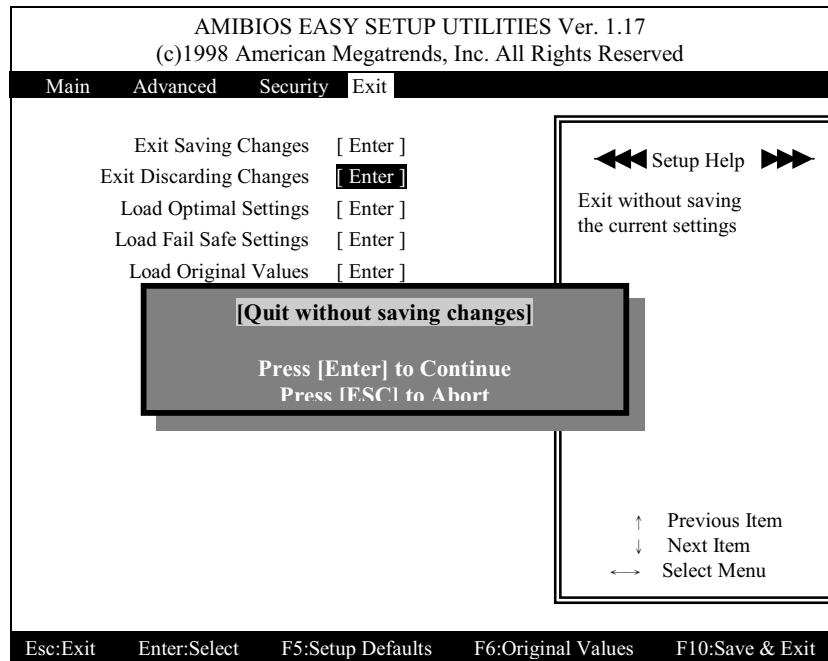

2.12 Load Optimal Settings

■ Figure 12. Load Optimal Settings

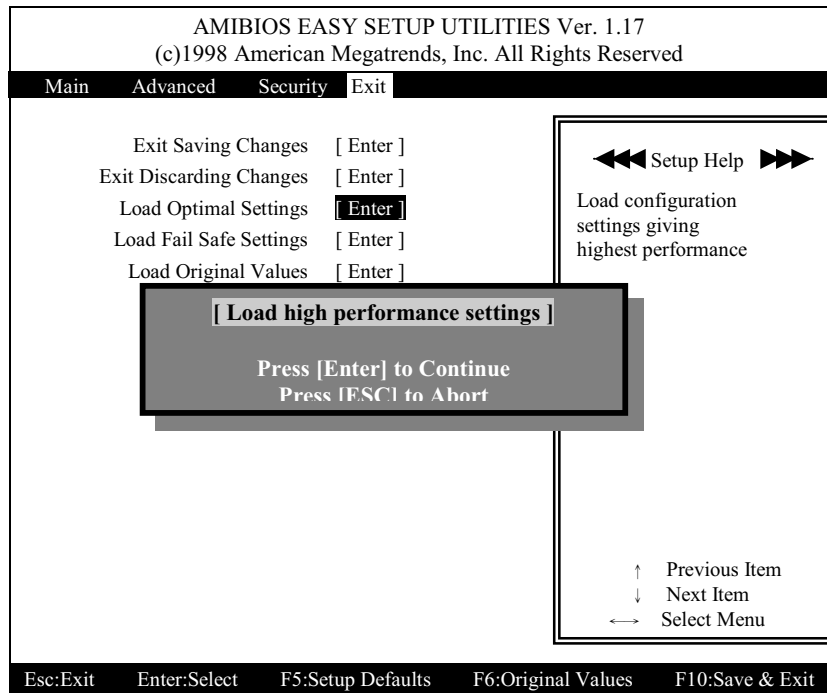

2.13 Load Fail Safe Settings

■ Figure 13. Load Optimal Settings

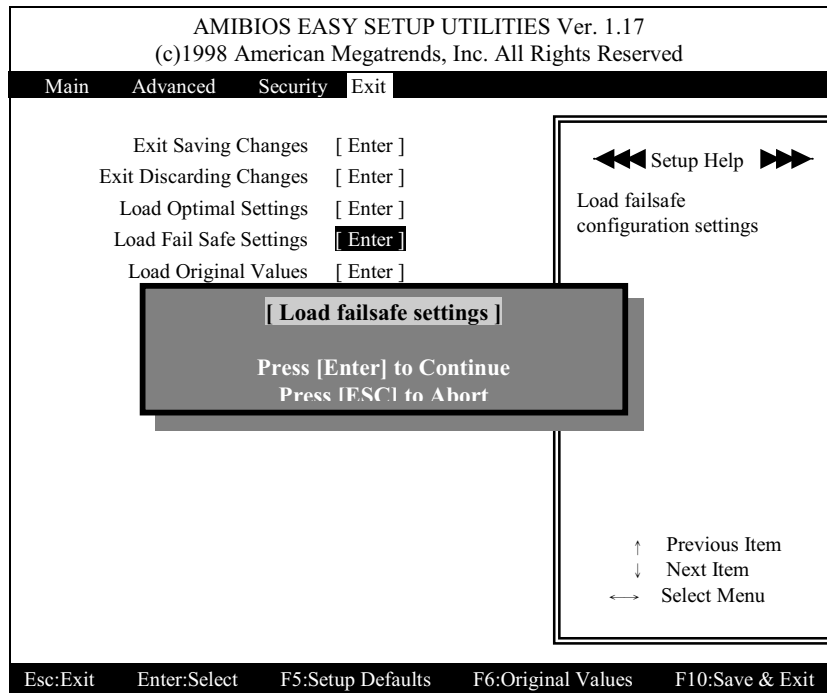

2.14 Load Original Values

■ Figure 14. Load Optimal Settings

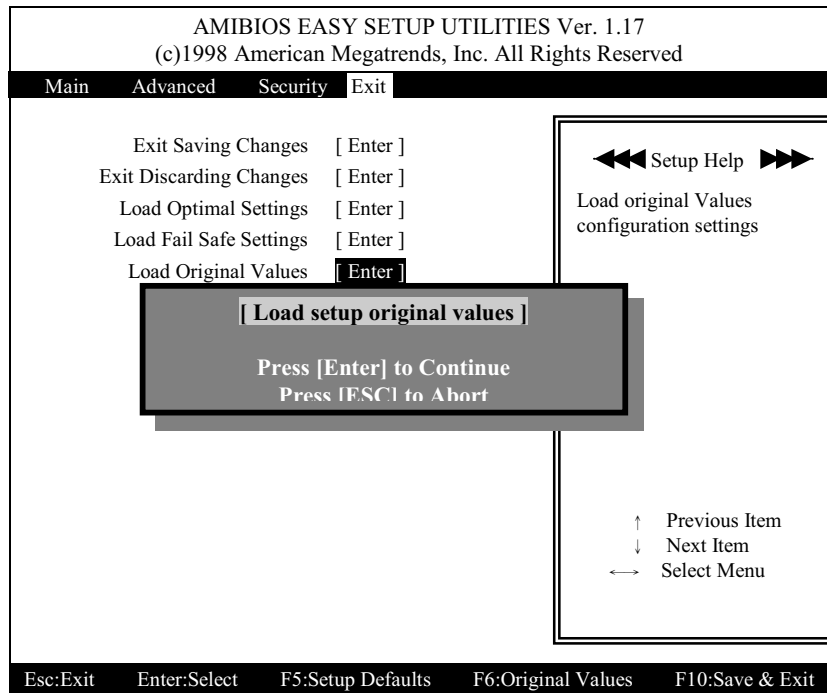

3 Software

3.1 Software List

Category	Description	Platform	Location in CD
Windows 9x Inf Patch Utility	INF Files that enable the IntelR 810, 810E and IntelR 820 Chipsets to be recognized by Windows operating systems. This installer will unpack updated .INF files into a specified folder.	Windows 95/98	.\Inf
HighPoint XStore Pro	Install the drivers to support Ultra DMA mode Hard Drive. It will provide higher Disk I/O performance	Windows 95/98	.\Mb_drv\Xstore
AMI FLASH BIOS Update Utility	Used for updating BIOS. (Please refer to chapter - Application Software in this manual.)	This utility is recommended to run under DOS environment.	.\Mb_drv\Flash
Sound Blaster PCI128	On-board Creative Sound Blaster PCI128 drivers and utilities.	Windows 95 /98 /NT4.0 /2000*	.\Audio\Sb_128\Setup

(Audio)			
Intel(R) PRO/100+ Management Adapter (LAN)	On-board Intel PRO/100+ Management Adapter drivers and utilities.	Windows 95 /98 /NT4.0* /2000*	Root of Driver CD
Microsoft DirectX	Microsoft DirectX runtime libraries.	Windows 95 /98 /2000	.\Directx

Note: The mark “ * “ means under the OS environment, you need to install driver manually. Please refer to the OS user’s manual to get more detailed information about driver installation.

3.2 Software Installation

We provide an installation wizard, Driver CD Installation Utility (START.EXE), located in the root of Driver CD to let users install some common used drivers conveniently.

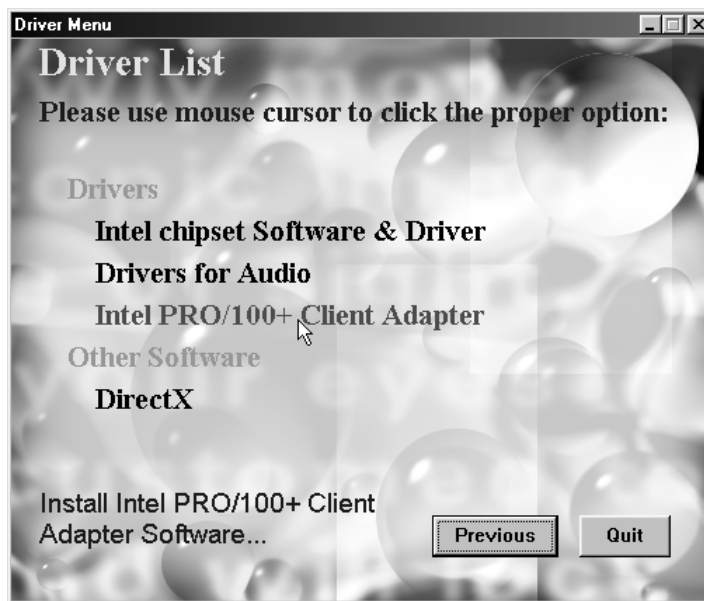

You can simply put Driver CD into CD-ROM drive and the Installation Utility will auto run or you can run the Driver CD Installation Utility directly by using mouse cursor to click the proper option on the page. Utility will invoke other applications to complete the rest of installation.

Note for Install Sound Blaster PCI128 drivers: The Creative Sound Blaster PCI128 driver installation procedure requires two steps.

Step1 - Use Driver CD Installation Utility to launch the Creative Sound Blaster PCI128 driver & utility setup program. Please finish the installation procedure according to the hints of setup program and then reboot.

Step2 - When you are prompted the below dialog after you have finished the Step1 and reenter the Windows environment, please simply click the “**Next**” button to continue.



Repeat to click the **“Next”** button in the following dialogs. Then the Creative drivers’ installation will be finally finished.



.
. .
. . .

3.3 Software Usage

3.3.1 Sound Blaster PCI128

After software installation completed, Creative Sound Blaster PCI128 driver & utility setup program will create a group of Creative Sound Blaster PCI128 utilities and help shortcuts as below.



- ✓ **Creative CD:** Creative CD operates like a home CD player, letting you play audio CDs from CD-ROM drives on your PC.
- ✓ **Creative Configurator:** The Creative Configurator allows you to view and change special features of your audio system.
- ✓ **Creative MIDI:** Creative MIDI is the player in the Multimedia Decks suite of players that lets you play MIDI files.
- ✓ **Creative Remote:** Creative Remote is the main component of the Creative Multimedia Decks group of players. Like a home remote control, it lets you control different Creative Multimedia Decks players from a single control interface. If you require more control over a player, you can also invoke the player from Creative Remote.
- ✓ **Creative Wave:** Creative Wave is the player in the Creative Multimedia Decks suite of players that lets you play wave files.
- ✓ **Soundo'LE:** Creative Soundo'LE plays and records wave data. It supports Object Linking and Embedding (OLE) 2.0.
- ✓ **Wave Studio:** WaveStudio is a Windows-based application that allows you to perform the sound editing functions easily.

- ✓ **SB PCI128 Mixer:** A mixer has been included for your audio card. This mixer accommodates various features available on your audio card. They are unavailable through the Windows mixer.

To start the mixer, simply double-click the Mixer icon in the Taskbar.



If you need more detailed information of the Creative Sound utilities, please refer to the User's Guide help file that comes with the utilities.

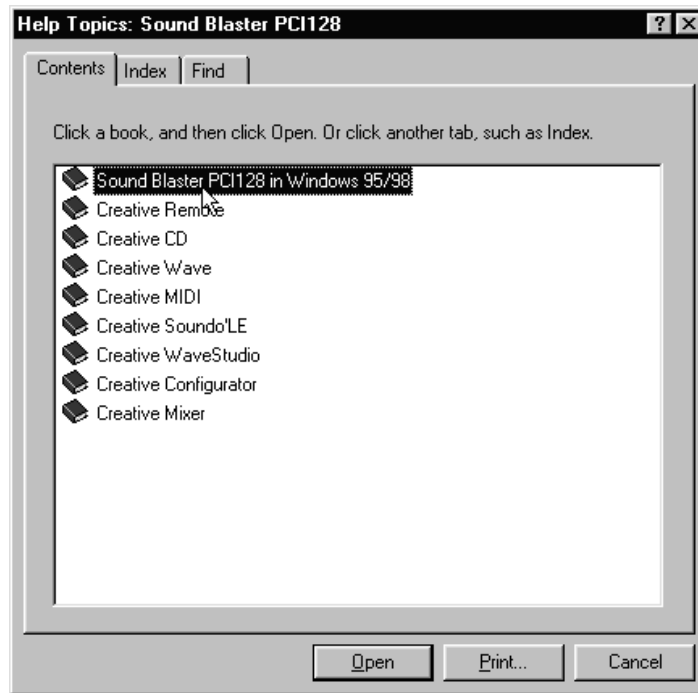

3.3.2 Intel(R) PRO/100+ Management Adapter

After software installation completed, Intel(R) PRO/100+ Management Adapter setup program will add an Intel® PROSet utility to your system.

Please double click the Intel® PROSet utility icon, which is located on the right side of Windows Taskbar, to launch the Intel® PROSet utility.



Or you can open the Control Panel, and double click the Intel® PROSet icon to launch the Intel® PROSet utility.

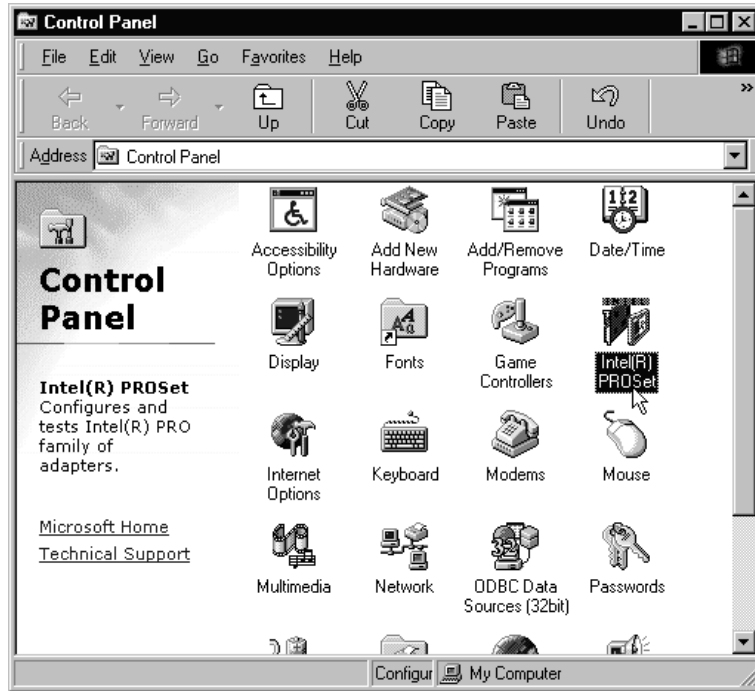

Intel® PROSet utility can provide you the information about your Network Adapter settings, Network Driver, Diagnostics, and Support.

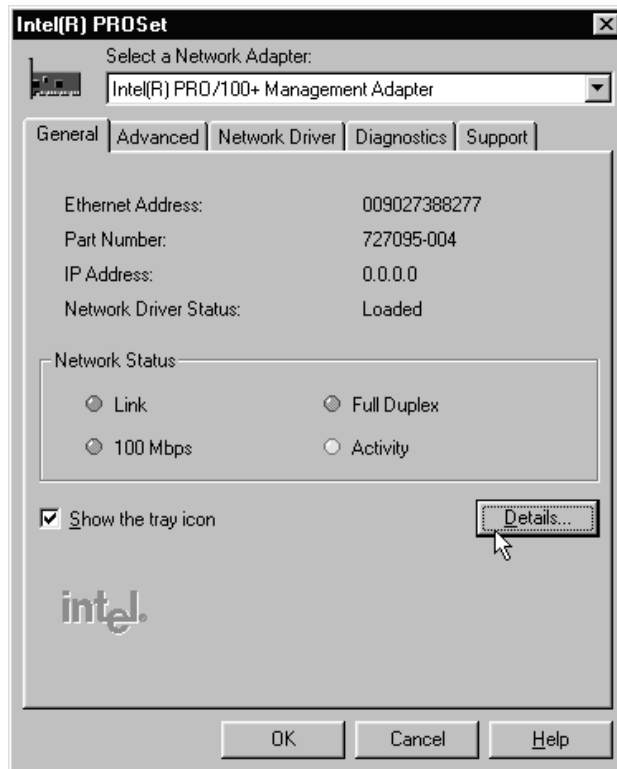

If you need more detailed information of the Intel® PROSet utility, please press “F1” button and then refer to the Intel® PROSet Help that comes with the utility.

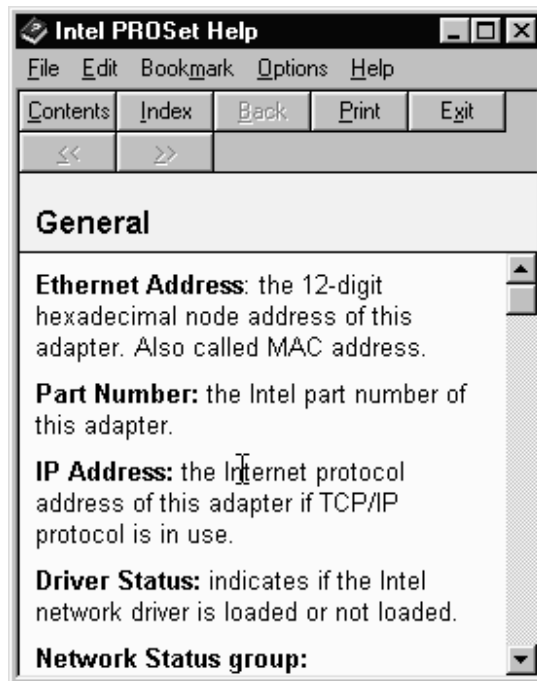

4 Trouble Shooting

PROBLEM

No power to the system at all. Power light does not illuminate, fan inside power supply does not turn on. Indicator light on keyboard does not turn on.

PROBABLE CAUSE	DIAGNOSIS	SOLUTION
Power cable is unplugged.	Visually inspect power cable.	Make sure power cable is securely plugged in.
Defective power cable.	Visually inspect the cable; try another cable.	Replace cable.
Power supply failure.	Power cable and wall socket are OK, but system is still dead.	Contact technical support.
Faulty wall outlet; circuit breaker or fuse blown.	Plug in device known to work in socket and test	Use different socket, repair outlet, reset circuit breaker or replace fuse.

PROBLEM

System inoperative. Keyboard lights are on, power indicator lights are lit, hard drive is spinning.

PROBABLE CAUSE	DIAGNOSIS	SOLUTION
Expansion card is partially dislodged from expansion slot on the motherboard.	Turn off computer. Take cover off system unit. Check all expansion cards to ensure they are securely seated in slots.	Using even pressure on both ends of the expansion card, press down firmly on expansion card.
Defective floppy disk drive or tape drive.	Turn system off. Disconnect the cables from one of the floppy drives. Turn on the floppy drives. Turn on the system, check to see if the keyboard operates normally. Repeat until you have located defective unit.	Contact Technical Support.
Defective expansion card.	Turn computer off. Remove an expansion card.	Make sure expansion card is secure in expansion socket.

PROBLEM

System does not boot from hard disk drive, can be booted from floppy disk drive.

PROBABLE CAUSE	DIAGNOSIS	SOLUTION
Connector between hard drive and system board unplugged.	When attempting to run the FDISK utility described in the HARD DISK section of this manual you get a message, INVALID DRIVE SPECIFICATION.	Check cable running from disk to disk controller board. Make sure both ends are securely plugged in; check the drive type in the standard CMOS setup.
Damaged hard disk or disk controller.	Format hard disk; if unable to do so the hard disk may be defective.	Contact technical support.
Hard disk directory or FAT is scrambled.	Run the FDISK program, format the hard drive. Copy data that was backed up onto hard drive.	Backing up the hard drive is extremely important. All hard disks are capable of breaking down at any time.

PROBLEM

System only boots from floppy Disk. Hard disk can be read and applications can be used but booting from Hard Disk is impossible.

PROBABLE CAUSE	DIAGNOSIS	SOLUTION
Hard disk boot program has been destroyed.	A number of causes could be behind this.	Back up data and applications files. Reformat the hard drive as described in the Hard Drive section of this manual. Re-install applications and data using backup disks.

PROBLEM

Error message reading "SECTOR NOT FOUND" or other error messages not allowing certain data to be retrieved.

PROBABLE CAUSE	DIAGNOSIS	SOLUTION
A number of causes could be behind this.	Use a file-by-file backup instead of an image backup in order to backup the hard disk.	Back up any salvageable data. Then low-level format, partition, and high-level format the hard drive. Re-install all saved data when completed.

PROBLEM

Disk formatted on IBM PS/2 will not operate with this system.

PROBABLE CAUSE	DIAGNOSIS	SOLUTION
The IBM PS/2 uses a different format from other computers.	IBM PS/2 disk format will not work in an AT type computer.	Format disk in the AT type computer insert disk into the IBM PS/2 and copy the files you wish.

PROBLEM

After installing an expansion card (network card, tape drive card, etc.) the system no longer works properly.

PROBABLE CAUSE	DIAGNOSIS	SOLUTION
No power to monitor.	All or part of the system may be inoperable. The new card may work but a mouse or COM port may not work.	Change the interrupt or RAM address on the new expansion card. See the documentation that came with the new card in order to change pin settings. Many expansion devices come with proprietary software that will assist you in doing this.

PROBLEM

Screen message says "Invalid Configuration" or "CMOS Failure."

PROBABLE CAUSE	DIAGNOSIS	SOLUTION
Incorrect information entered into the configuration (setup) program.	Check the configuration program. Replace any incorrect information.	Review system's equipment . Make sure correct information is in setup.

PROBLEM

Screen is blank.

PROBABLE CAUSE	DIAGNOSIS	SOLUTION
No power to monitor.		Check the power connectors to monitor and to system. Make sure monitor is connected to display card, change I/O address on network card if applicable.
Monitor not connected to computer.		See instructions above.
Network card I/O address conflict.		See instructions above.

PROBLEM

PROBABLE CAUSE	DIAGNOSIS	SOLUTION
Memory problem, display card jumpers not set correctly.		Reboot computer. Reinstall memory, make sure that all memory modules are installed in correct sockets. Check jumper and switch settings on display card. See display card section for information on settings.
Computer virus.		Use anti-virus programs (McAfee, E-Prot, etc) to detect and clean viruses.

PROBLEM

Screen goes blank periodically.

PROBABLE CAUSE	DIAGNOSIS	SOLUTION
Screen saver is enabled.		Disable screen saver.

PROBLEM

Keyboard failure.

PROBABLE CAUSE	DIAGNOSIS	SOLUTION
Keyboard is disconnected.		Reconnect keyboard. Check keys again, if no improvement replace keyboard.

PROBLEM

No color on screen.

PROBABLE CAUSE	DIAGNOSIS	SOLUTION
Faulty Monitor.		If possible, connect monitor to another system. If no color replace monitor.
CMOS incorrectly set up.		Call technical support.

PROBLEM

Floppy drive light stays on.

PROBABLE CAUSE	DIAGNOSIS	SOLUTION
Floppy Drive cable not connected correctly.		Reconnect floppy cable making sure PIN1 on the Floppy Drive corresponds with PIN1 on Floppy cable connector.

PROBLEM

Error reading drive A:

PROBABLE CAUSE	DIAGNOSIS	SOLUTION
Bad floppy disk.		Try new floppy disk
Floppy disk not formatted.		Format floppy disk (type FORMAT A: type ENTER).

PROBLEM

C: drive failure.

PROBABLE CAUSE	DIAGNOSIS	SOLUTION
SETUP program does not have correct information.		Boot from drive A: using DOS system disk. Input correct information to SETUP program.
Hard drive cable not connected properly.		Check hard drive cable.

PROBLEM

Cannot boot system after installing second hard drive.

PROBABLE CAUSE	DIAGNOSIS	SOLUTION
Master/slave jumpers not set correctly.		Set master/slave jumpers correctly.
Hard drives not		Run SETUP program and

compatible / different manufacturers.		select correct drive types. Call drive manufacturers for compatibility with other drives.
---------------------------------------	--	---

PROBLEM

Missing operating system on hard drive.

PROBABLE CAUSE	DIAGNOSIS	SOLUTION
CMOS setup has been changed.		Run setup and select correct drive type.

PROBLEM

Certain keys do not function.

PROBABLE CAUSE	DIAGNOSIS	SOLUTION
Keys jammed or defective.		Replace keyboard.

PROBLEM

Keyboard is locked, and no keys function.

PROBABLE CAUSE	DIAGNOSIS	SOLUTION
Keyboard is locked.		Unlock keyboard.

12/14/1999
MADE IN TAIWAN
R.O.C