

---

## **Federal Communications Commission (F.C.C) Statement**

This device complies with Part 15 of the FCC Rules. Operation of this device is subject to the following two conditions: (1) this device may not cause harmful interference, and (2) this device must accept any interference received, including interference that may cause undesired operation.

Accessories: This device has been tested and found to comply with the limits of a Class B digital device, the accessories associated with this equipment are as follows:

1. Shielded serial cable. (Can be obtained from multiple retail outlets)
2. Shielded printer cable. (Can be obtained from multiple retail outlets)
3. Shielded video cable. (Can be obtained from multiple retail outlets)
4. Shielded power cord. (Provided by manufacturer)

These accessories are required to be used in order to ensure compliance with FCC Rules. It is the responsibility of the user to provide and use these accessories properly.

This equipment has been tested and found to comply with the limits of a Class B digital device, pursuant to Part 15 of the FCC Rules. These limits are designed to provide reasonable protection against harmful interference in a residential installation. This equipment generates, uses and can radiate radio frequency energy and, if not installed and used in accordance with the instructions, may cause harmful interference to radio communications. However, there is no guarantee that interference will not occur in a particular installation. If this equipment does cause harmful interference to radio or television reception, which can be determined by turning the equipment off and on, the user is encouraged to try to correct the interference by one or more of the following measures:

1. Reorient / Relocate the receiving antenna.
2. Increase the separation between the equipment and receiver.
3. Connect the equipment into an outlet on a circuit different from that to which the receiver is connected.
4. Consult the dealer or an experienced radio/TV technician for help.

Caution: Changes or modifications not expressly approved by the manufacturer could void the user's authority to operate the equipment.

---

---

## Disclaimer

The Vendor makes no representations or warranties with respect to the contents hereof and specially disclaims any implied warranties of merchantability or fitness for any purpose. Further the Vendor reserves the right to revise this publication and to make changes from time to time in the contents hereof without obligation to notify any party beforehand.

Duplication of this publication, in part or in whole, is not allowed without first obtaining the Vendor's approval in writing.

## Trademarks and Remarks

MS-DOS, Windows, Windows NT, and Windows 9x are products of Microsoft Corp, with its ownership of trademark, and are distributed by the Vendor under a license agreement.

All trademarks used in this manual are the property of their respective owners.

Copyright(C) 1992

All Rights Reserved

## Canadian D.O.C. Statement

This digital apparatus does not exceed the Class B limits for radio noise emissions from digital apparatus as set out in the radio interference regulations of the Canadian Department of Communications.

And

Le present appareil numerique n'emet pas de bruits radioelectriques depassant les limites appliques aux appareils numeriques de Class B prescripts Dan le regalement usr le brouillage radioelectrique edict par le minister Des Communications du Canada.

---

## **Contents**

---

<b>Introduction .....</b>	<b>1-1</b>
<b>1 Motherboard Description .....</b>	<b>1-2</b>
1.1 Features .....	1-2
1.1.1 Hardware .....	1-2
1.1.2 Software .....	1-5
1.1.3 Attachments .....	1-5
1.2 Motherboard Installation .....	1-6
1.2.1 Layout of Motherboard .....	1-6
1.3 Motherboard Connectors .....	1-7
1.3.1 Front Panel Connectors (J12) .....	1-8
1.3.2 Floppy Disk Connector (J5) .....	1-9
1.3.3 Hard Disk Connectors (J9/J10) .....	1-9
1.3.4 ATX 20-pin Power Connector (J13) .....	1-10
1.4 Back Panel Connectors .....	1-11
1.4.1 PS/2 Mouse / Keyboard Connectors (J8) .....	1-11
1.4.2 USB Connectors (J11) .....	1-12
1.5 Serial and Parallel Interface Ports .....	1-13
1.6 CPU Installation .....	1-18
1.6.1 CPU Installation Procedure .....	1-18
1.6.2 CPU Cooling Fan Power Connector (J1) .....	1-19
1.7 Jumper Settings .....	1-20
1.7.1 Bus Clock Select (JP1) .....	1-21

## **Contents**

---

1.7.2 CMOS Function Selection (JP2) .....	1-21
1.7.3 Multiplier Select (JP3) .....	1-22
1.7.4 Wake-On-LAN Header (J7) .....	1-22
1.7.5 Wake-On- Internal Modem (J8) .....	1-23
1.8 DRAM Installation.....	1-24
1.8.1 DIMM .....	1-24
1.8.2 How to install a DIMM Module.....	1-26
1.9 Audio Subsystem.....	1-27
1.9.1 CD Audio Input Connector (J15) .....	1-29
1.9.2 CD Audio Input Connector (J16) .....	1-29
1.9.3 Telephony Connector (J21).....	1-29
<b>2. AWARD BIOS Setup .....</b>	<b>2-1</b>
2.1 Main Menu.....	2-3
2.2 Standard CMOS Setup .....	2-5
2.3 BIOS Features Setup .....	2-9
2.4 Chipset Features Setup .....	2-14
2.5 Power Management Setup.....	2-17
2.6 PNP / PCI Configuration Setup.....	2-22
2.7 Load Setup Defaults.....	2-25
2.8 Integrated Peripherals Setup .....	2-26
2.9 Supervisor / User Password Setting .....	2-29
2.10 IDE HDD Auto Detection.....	2-30
2.11 Save & Exit Setup .....	2-31

## **Contents**

---

2.12 Exit Without Saving .....	2-32
2.13 Application Software .....	2-33
<b>3 Software.....</b>	<b>3-1</b>
3.1 Motherboard Software .....	3-1
3.1.1 Software List .....	3-1
3.1.2 Software Installation.....	3-2
3.1.3 Using Software .....	3-3
3.2 ESS Solo-1 (on-board) Software.....	3-5
3.2.1 Software List .....	3-5
3.2.2 Software Installation.....	3-6
3.2.3 Using Software .....	3-7
<b>4. Trouble Shooting .....</b>	<b>4-1</b>

## Introduction

### System Overview

Thanks for buying this product! This manual was written to help you start using this product as quickly and smoothly as possible. Inside you will find adequate explanations to solve most problems. In order for this reference material to be of greatest use, refer to the “expanded table of contents” to find relevant topics.

This board incorporates the system board, ISA I/O, and PCI IDE into one board that provides a total PC solution. The motherboard, Celeron™ processor based PC/ATX system, with ISA Bus, AGP Bus and PCI Local Bus to support upgrades to your system performance. It is ideal for multi-tasking and fully supports MS-DOS, Windows, Windows NT, Novell, OS/2, Windows9x, UNIX, SCO UNIX etc. This manual also explains how to install the motherboard for operation, and how to setup your CMOS configuration with the BIOS setup program.

# 1 Motherboard Description

## 1.1 Features

### 1.1.1 Hardware

#### CPU

- The Celeron™ processor (PPGA) the new generation power for high-end workstations and servers.
- Provides PPGA 370.

#### Speed

- Supports 33 MHz PCI Bus speed.
- I/O clock 8 MHz for ISA Bus.
- Supports 66MHz / 133 MHz AGP Bus.

#### DRAM Memory

- Supports 8/16/32/64....MB DIMM module sockets.
- Synchronous DRAM (3.3V).
- Supports a maximum memory size of 384MB with SDRAM.

#### Flash Memory

- Supports flash memory.
- Supports ESCD Function.

#### Shadow RAM

- A memory controller that provides shadow RAM and supports 8-bit ROM BIOS.

#### Green Function

- Supports power management operation via BIOS.
- Power down timer from 1 min to 1Hour.
- Wake up by any key pressed or mouse activity.

**BUS Slots**

- Provides one 16-bit ISA Bus slot and three PCI Bus slots, one AGP Bus slot.

**PCI Enhanced IDE Built-in On Board**

- Supports 4 IDE hard disk drives.
- Supports PIO mode 4, Master Mode high performance hard disk drives.
- Supports Ultra DMA/33, Bus Master Mode.
- Supports IDE interface with CD-ROM.
- Supports high capacity hard disk drives.
- Supports LBA mode.

**PCI Sound Built-in Onboard**

- ESS™ Solo1™ Sound Chip.
- Full native DOS games compatibility.
- High-Quality ESFM music synthesizer.
- Software Wavetable synthesizer.
- Integrated Spatializer 3D audio effects processor.
- 16-Bit stereo ADC and DAC.
- Full-Duplex operation for simultaneous record and playback.
- Supports
  - (1) PC games and applications for Sound Blaster™ and Sound Blaster Pro™.
  - (2) Microsoft Windows Sound System, PC 97™/PC 98™ and WHQL™ specifications.



**ISA I/O Built-in Onboard**

- Supports one multi-mode Parallel Port:
  - (1) Standard & Bidirection Parallel Port.
  - (2) Enhanced Parallel Port (EPP).
  - (3) Extended Capabilities Port (ECP).
- Supports two serial ports, 16550 UART.
- Supports one Infrared transmission (IR).(optional)
- Supports PS/2 Mouse.
- Supports 360KB, 720KB, 1.2MB, 1.44MB and 2.88MB floppy disk drives.

**Hardware Monitor Subsystem (Optional)**

The hardware monitor subsystem provides low-cost instrumentation capabilities. The features of the hardware monitor subsystem include:

- Management Level 4 functionality
- Microprocessor System Hardware Monitor:
  - Integrated temperature and voltage monitoring to detect levels above or below acceptable values(+12V, -12V, +5V, +3.3V, -5V). When suggested ratings for temperature, fan speed, or voltage are exceeded, an interrupt is activated.
  - One fan speed sensor.
  - Access through the SMBus.
- Remote reset capabilities from a remote peer or server through Intel LANDesk 3.3(or later) Client Manager and service layers.

**Universal Serial Bus**

- Supports two Universal Serial Bus (U.S.B.) Ports.
- Supports 48MHz USB.

**Dimensions(MicroATX form-factor)**

- 24.4 cm X 19.5 cm (W x L).

## **1.1.2 Software**

### **BIOS**

- AWARD legal friendly BIOS.
- Supports APM1.2.
- Supports USB Function.
- Setting the CPU Host frequency.

### **Operating System**

- Offers the highest performance for MS-DOS, OS/2, Windows, Windows NT, Windows 9x, Novell, UNIX, SCO UNIX etc.

## **1.1.3 Attachments**

### **Attachments**

- HDD Cable.
- FDD Cable.
- CD for IDE Driver, Sound Driver and BIOS flash writer utility.

## 1.2 Motherboard Installation

### 1.2.1 Layout of Motherboard

Model No.M6TLH

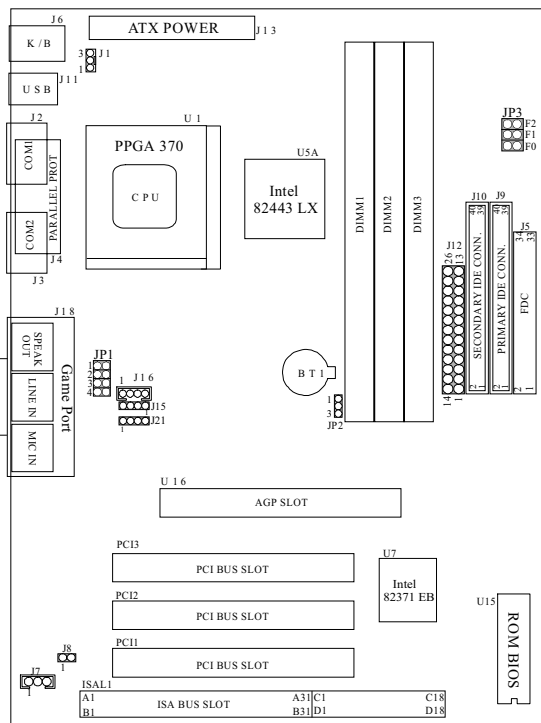

## 1.3 Motherboard Connectors

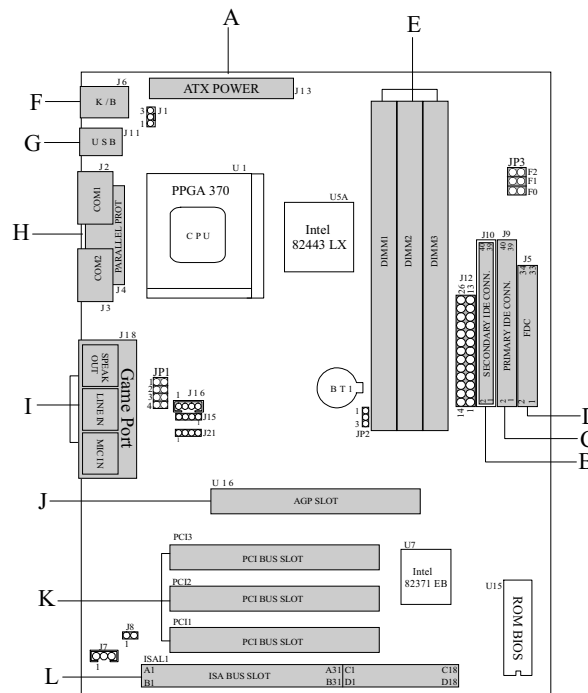

- A. ATX Power Connector (J13)
- B. Secondary IDE Connector (J10)
- C. Primary IDE Connector (J9)
- D. Floppy Disk Connector (J5)
- E. DIMMs (DIMM1-3)
- F. Keyboard & Mouse PS/2 Connectors (J6)

- G. USB Connectors (J11)
- H. Parallel Port Connector (J4)
- I. Game Port Connector (J18)
- J. AGP Slot (U16)
- K. PCI BUS Slots (PCI1-3)
- L. ISA BUS Slot (ISAL1)

### 1.3.1 Front Panel Connectors (J12)

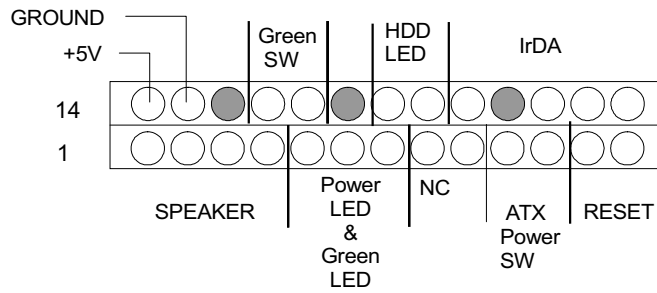

Pin No.	Assignment	Function	Pin No.	Assignment	Function
1	Speaker	Speaker Connector	14	+5V	VCC
2	NC		15	Ground	Ground
3	Ground		16	No Connection	NC
4	+5V		17	Green Control	Green Switch
5	Power LED(+)	18	Ground		
6	No Connection	Power LED & Green LED	19	No Connection	NC
7	LED(-)		20	HDD LED(-)	HDD LED
8	No Connection	NC	21	HDD LED(+)	
9	No Connection	ATX Power Button	22	+5V	IrDA Connector
10	Power Switch		23	No Connection	
11	Standby Voltage		24	IRRX	
12	Reset Control	Reset	25	Ground	
13	Ground	26	IRTX		

### 1.3.2 Floppy Disk Connector (J5)

The motherboard also provides a standard Floppy Disk Connector (FDC) that supports 360K, 720K, 1.2M, and 2.88M floppy disk types.

This connector supports floppy drive ribbon cables.

### 1.3.3 Hard Disk Connectors (J9/J10)

The motherboard has a 32-bit Enhanced PCI IDE Controller that provides PIO Mode 0~4, Bus Master, and Ultra DMA / 33 functionality. It has two HDD connectors IDE1 (primary) and IDE2 (secondary). You can connect up to four hard disk drives, a CD-ROM, a 120MB Floppy (reserved for future BIOS) and other devices to IDE1 and IDE2. These connectors support the IDE hard disk cable provided.

- IDE1 (Primary IDE Connector)

The first hard drive should always be connected to IDE1. IDE1 can connect a Master and a Slave drive. You must configure the second hard drive on IDE1 to Slave mode by setting the jumper accordingly.

- IDE2 (Secondary IDE Connector)

- The IDE2 controller can also support Master and Slave drives. The configuration is similar to IDE1. The second drive on this controller must be set to slave mode.

#### 1.3.3 Back Panel Connectors

### 1.3.4 ATX 20-pin Power Connector (J13)

This connector supports the onboard power button. Using the ATX power supply, functions such as Modem Ring Wake-Up and Soft Power-Off are supported by this motherboard. This power connector supports Instant Power-On functionality, which means that the system will boot up instantly when the power connector is inserted on the board.

PIN	SIGNAL	PIN	SIGNAL
1	3.3V	11	3.3V
2	3.3V	12	-12V
3	GND	13	GND
4	5V	14	PS_ON
5	GND	15	GND
6	5V	16	GND
7	GND	17	GND
8	PW_OK	18	-5V
9	5V_SB	19	5V
10	12V	20	5V

## 1.4 Back Panel Connectors

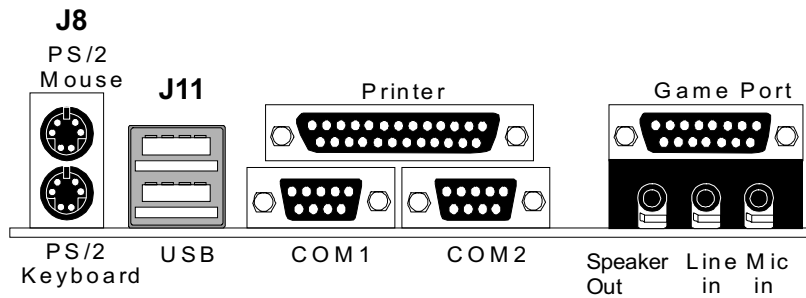

### 1.4.1 PS/2 Mouse / Keyboard Connectors (J8)

The motherboard provides a standard PS/2 mouse / Keyboard mini DIN connector for attaching a PS/2 mouse. You can plug a PS/2 mouse / Keyboard directly into this connector. The connector locations and pin definition are shown below:

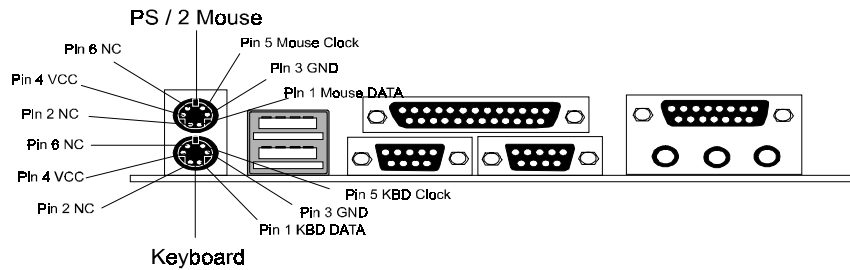



**PS/2 Mouse / Keyboard Connectors**

Pin	Signal Name
1	Data
2	No connect
3	Ground
4	+5 V (fused)
5	Clock
6	No connect

**1.4.2 USB Connectors (J11)**

The motherboard provides a **OHCI (Open Host Controller Interface) Universal Serial Bus roots** for attaching USB devices such as: keyboard, mouse and other USB devices. You can plug the USB devices directly into this connector.

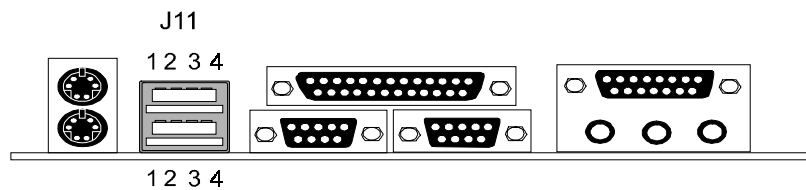
**Stacked USB Connectors**

Pin	Signal Name
1	+5 V (fused)
2	USBP0- [USBP1-]
3	USBP0+ [USBP1+]
4	Ground

## 1.5 Serial and Parallel Interface Ports

This system equipped with two serial ports and one parallel port. Both types of interface ports will be explained in this chapter.

### The Serial Interface Port

The serial interface port is sometimes referred to as a RS-232 port or an asynchronous communications port. Mice, printers, modems and other peripheral devices can be connected to a serial port. The serial port can also be used to connect your computer with another computer system. If you wish to transfer the contents of your hard disk to another system it can be accomplished by using each machine's serial port.

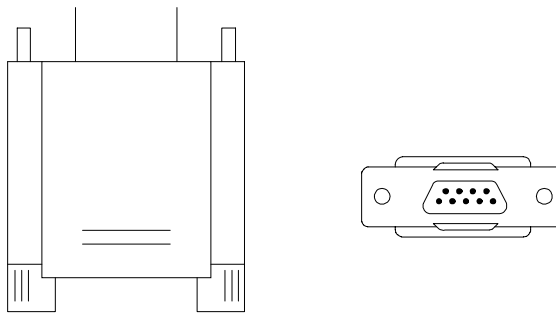

The serial ports on this system have two types of connectors, one 9-pin and one 25-pin. Some older computer systems and peripherals may only have a 25-pin connector. Should you need to connect your 9-pin serial port to a 25-pin serial port, you can purchase a 9-to-25 pin adapter.

## Connectivity

The many ways that a serial port can be used make it necessary to be familiarized with the pinout diagram. The following chart gives you the function of each pin on the 9-pin connector. This information can be used when configuring certain software programs to work with the serial port.

Signal	Name	DB9 PIN	DB25 PIN
DCD	Data Carrier Detect	1	8
RX	Receive Data	2	3
TX	Transmit Data	3	2
DTR	Data Terminal Ready	4	20
GND	Signal Ground	5	7
DSR	Data Set Ready	6	6
RTS	Request to Send	7	4
CTS	Clear to Send	8	5
RI	Ring Indicator	9	22

## Special Applications

There are two types of serial devices that can be connected to a serial port. One of the devices is called the “DTE” (Data Terminal Equipment) and the other device is called the “DCE” (Data Communications Equipment). If a modem is connected to a computer, for example, the modem is called the DCE and the computer is called the DTE. In situations such as this, the pins on the serial ports can be connected straight through.

In instances when there are two DTE devices connected together, such as a computer and a printer, a special adapter called a “Null Modem” is needed to make communication between the two devices possible.

When using the serial port to communicate between devices, one problem in particular may arise. Some manufacturers use one set of signals to begin communication with another device and other manufacturers do not use these signals to begin communication. If you encounter a communication problem that cannot be resolved using a null modem, it can generally be assumed that one device is using the initialization signals and the other device is not. This can usually be resolved by wiring the RTS, CTS, and DCD pins together.

## Serial Ports/COM Ports

The two serial ports on the computer are called COM1 and COM2, respectively. If you wish, two more serial ports can be added onto the computer using optional hardware. Should you choose to add the extra Serial ports (COM ports), they would be called COM3 and COM4.

When using serial ports to communicate with a peripheral devices, be sure to assign only one COM port number to each device. For example, if a printer and a scanner are both connected to your computer through serial ports the printer must be assigned one COM port (i.e. COM1) and the scanner must be assigned the other COM port (i.e. COM2). No two devices can be assigned to one COM port. Each peripheral must have its own COM port.

**NOTE: Four serial ports may be installed on the computer. However, no more than two ports can be used simultaneously.**

\*If you have installed an internal modem, be careful not to assign a COM port number that has already been assigned to another device. This error is common.

When installing a device that is going to require the use of a serial port, use a diagnostic program to find out which ports are available. It may be necessary to remove expansion cards that have serial ports in order to check their jumper settings. The jumper settings will indicate which COM port the card has been assigned. Checking the expansion card will eliminate mistakes in overlapping COM ports. Once you have completed the installation of peripheral devices using the serial ports, be sure that the communication parameters such as baud rate, parity bit, etc. are matching. If your computer is set for a baud rate of 9600 and your modem is set for a baud rate of 2400, you will not be able to send messages. The manuals that accompany the peripheral devices will inform you on the procedure for setting their parameters. Software manuals will also have instructions on setting parameters.

## Parallel Interface Port

Unlike the serial port, parallel interface ports have been standardized and should not present any difficulty interfacing peripherals to your system. Sometimes called a Centronics port, the parallel port is almost exclusively used with printers. The parallel port on your system has a 25-pin, DB5 connector (see picture below). The pinouts for the parallel port are shown in the table below.

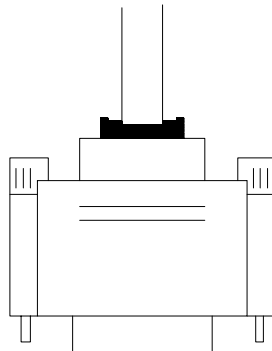
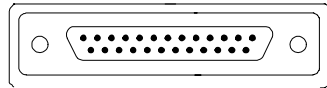

Signal	Pin
-Strobe	1
Data 0	2
Data 1	3
Data 2	4
Data 3	5
Data 4	6
Data 5	7
Data 6	8
Data 7	9
-Ack	10
Busy	11
Paper Empty	12
+Select	13
-Auto FDXT	14
-Error	15
-Init	16
-SLCTN	17
Ground	18
Ground	19
Ground	20
Ground	21
Ground	22
Ground	23
Ground	24
Ground	25

## 1.6 CPU Installation

### 1.6.1 CPU Installation Procedure

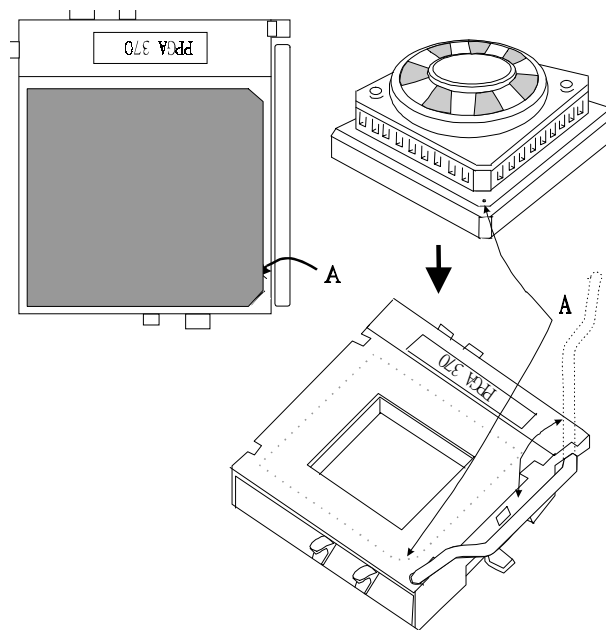

1. Pull the lever sideways away from the socket then raise the lever up to a 90-degree angle.
2. Locate Pin A in the socket and look for the white dot or cut edge in the CPU. Match Pin A with the white dot/cut edge then insert the CPU.
3. Press the lever down to complete the installation.

### 1.6.2 CPU Cooling Fan Power Connector (J1)

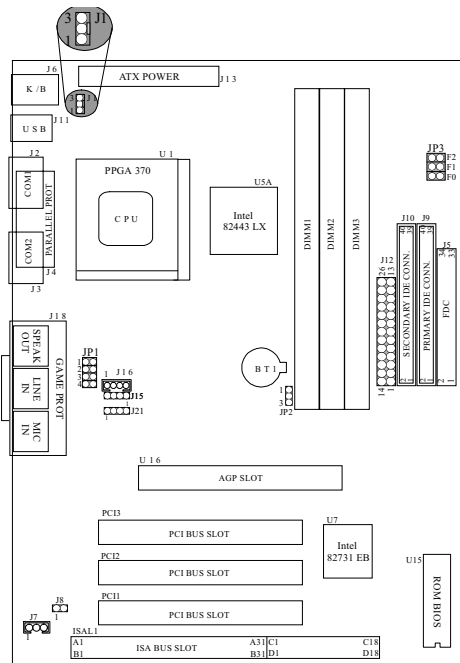

Pin No.	Assignment
1	Controller Pin
2	+12V
3	Sense



## 1.7 Jumper Settings

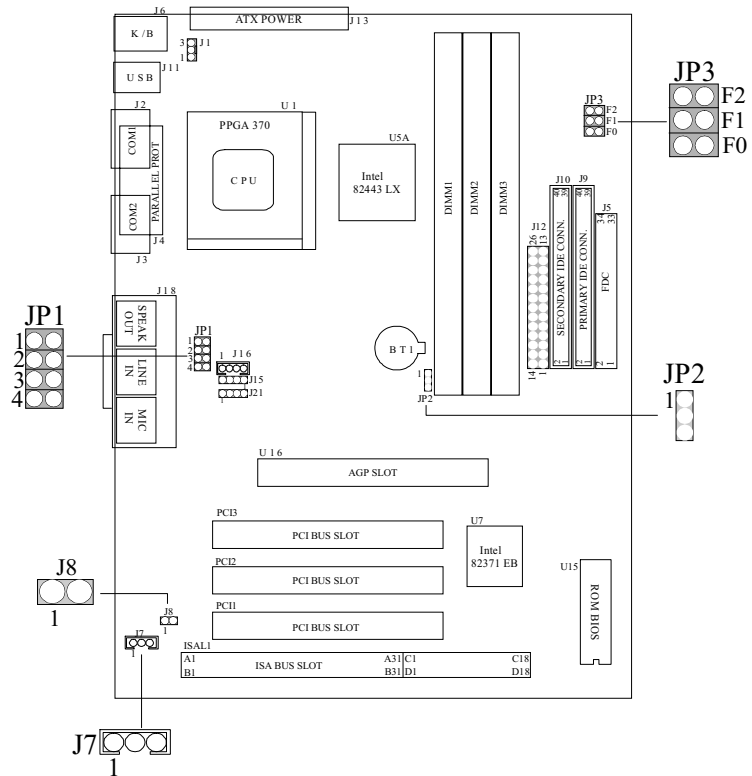

A jumper is two or more pins which may be covered by a plastic jumper cap, allowing you to select different system options.



### 1.7.1 Bus Clock Select (JP1)

JP1	1	2	3	4
X2.0	OPEN	OPEN	OPEN	OPEN
X2.5	OPEN	CLOSE	CLOSE	CLOSE
X3.0	CLOSE	OPEN	CLOSE	CLOSE
X3.5	OPEN	OPEN	CLOSE	CLOSE
X4.0	CLOSE	CLOSE	OPEN	CLOSE
X4.5	OPEN	CLOSE	OPEN	CLOSE
X5.0	CLOSE	OPEN	OPEN	CLOSE
X5.5	OPEN	OPEN	OPEN	CLOSE
X6.0	CLOSE	CLOSE	CLOSE	OPEN
X 6.5	OPEN	CLOSE	CLOSE	OPEN
X7.0	CLOSE	OPEN	CLOSE	OPEN
X 7.5	POEN	OPEN	CLOSE	OPEN
X8.0	CLOSE	CLOSE	OPEN	OPEN

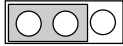
### 1.7.2 CMOS Function Selection (JP2)

JP2	Assignment
<p>1      3</p>  <p>1-2 Closed</p>	Normal Operation
<p>1      3</p>  <p>2-3 Closed</p>	Clear CMOS Data
<p>1      3</p>  <p>Open</p>	Onboard Battery Disabled

**\*Note :** Please follow the procedure as below to clear CMOS Data.

**Note :** Please follow the procedure as below to clear BIOS Password if your password is lost or forgotten.

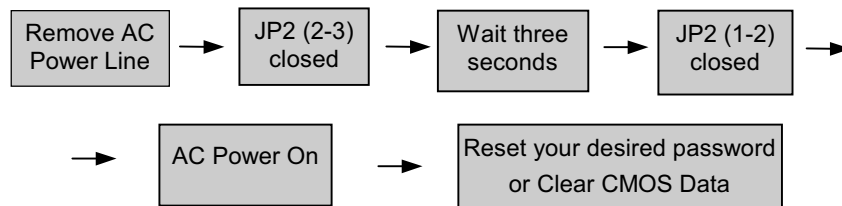

### 1.7.3 Multiplier Select (JP3)

JP3	F0	F1	F2
66MHz	OPEN	OPEN	OPEN
68MHz	OPEN	OPEN	CLOSE
75MHz	OPEN	CLOSE	OPEN
83MHz	CLOSE	OPEN	CLOSE

Note : 68MHz, 75MHz and 83MHz are overspec, No Commend to Use.

### 1.7.4 Wake-On-LAN Header (J7)

Pin No.	Assignment
1	+5 VSB
2	Ground
3	MP-Wakeup

**1.7.5 Wake-On- Internal Modem (J8)**

<b>Pin No.</b>	<b>Assignment</b>
1	Ring
2	GND

## 1.8 DRAM Installation

### 1.8.1 DIMM

DRAM Access Time : 3.3V Unbuffered SDRAM 15ns required.

DRAM Type:8MB/16MB/32MB/64MB/128MB DIMM Module (168pin)

Total	Bank 0	Bank 1	Bank 2
Memory Size (MB)	DIMM 1	DIMM 2	DIMM 3
8M	8M x 1 pc	----	----
16M	16M x 1 pc	----	----
32M	32M x 1 pc	----	----
64M	64M x 1 pc	----	----
128M	128M x 1 pc	----	----
24M	8M x 1 pc	8M x 1 pc	8M x 1 pc
32M	16M x 1 pc	8M x 1 pc	8M x 1 pc
48M	32M x 1 pc	8M x 1 pc	8M x 1 pc
80M	64M x 1 pc	8M x 1 pc	8M x 1 pc
144M	128M x 1 pc	8M x 1 pc	8M x 1 pc
40M	8M x 1 pc	16M x 1 pc	16M x 1 pc
48M	16M x 1 pc	16M x 1 pc	16M x 1 pc
64M	32M x 1 pc	16M x 1 pc	16M x 1 pc
96M	64M x 1 pc	16M x 1 pc	16M x 1 pc
160M	128M x 1 pc	16M x 1 pc	16M x 1 pc
72M	8M x 1 pc	32M x 1 pc	32M x 1 pc
80M	16M x 1 pc	32M x 1 pc	32M x 1 pc
96M	32M x 1 pc	32M x 1 pc	32M x 1 pc
128M	64M x 1 pc	32M x 1 pc	32M x 1 pc
192M	128M x 1 pc	32M x 1 pc	32M x 1 pc
136M	8M x 1 pc	64M x 1 pc	64M x 1 pc
144M	16M x 1 pc	64M x 1 pc	64M x 1 pc
160M	32M x 1 pc	64M x 1 pc	64M x 1 pc
192M	64M x 1 pc	64M x 1 pc	64M x 1 pc
256M	128M x 1 pc	64M x 1 pc	64M x 1 pc
384M	128M x 1 pc	128M x 1 pc	128M x 1 pc

*\*Each Bank can be installed and used individually. The motherboard provides optimal performance and free choices depending on your needs.*

*\*The list show above for DRAM configuration is just for reference.*

## 1.8.2 How to install a DIMM Module

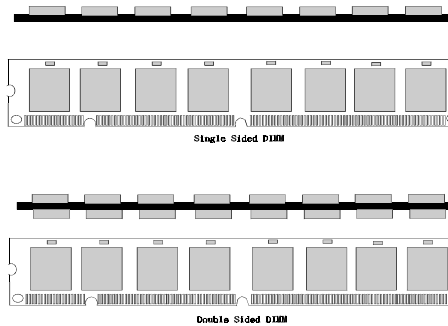

4. The DIMM slot has a "Plastic Safety Tab" and the DIMM memory module has an "asymmetrical notch", so the DIMM memory module can only fit in one direction.

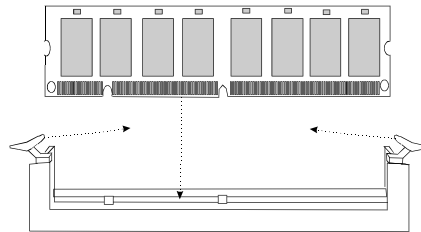

5. Push the tabs out. Insert the DIMM memory modules into the socket at 90-degree angle, then push down a vertically so that it will fit into place.

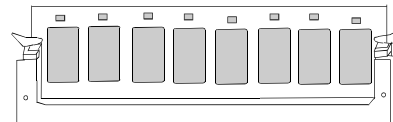

6. The Mounting Holes and plastic tabs should fit over the edge and hold the DIMM memory modules in place.

## 1.9 Audio Subsystem

**Chipset:**

- ESS ES1938S Solo-1

**Interface:**

- PCI Interface

**Features**

- Full native DOS games compatibility.
- High-Quality ESFM music synthesizer.
- Software Wavetable synthesizer.
- Integrated Spatializer 3D audio effects processor.
- 16-Bit stereo ACD and DAC.
- Full-Duplex operation for simultaneous record and playback.
- Advanced power management meets ACPI standards.
- Supports PC games and applications for Sound Blaster and Sound Blaster Pro, Microsoft Windows Sound System, PC 97/PC 98 and WHQL specifications.
- PCI 2.1 interface support.



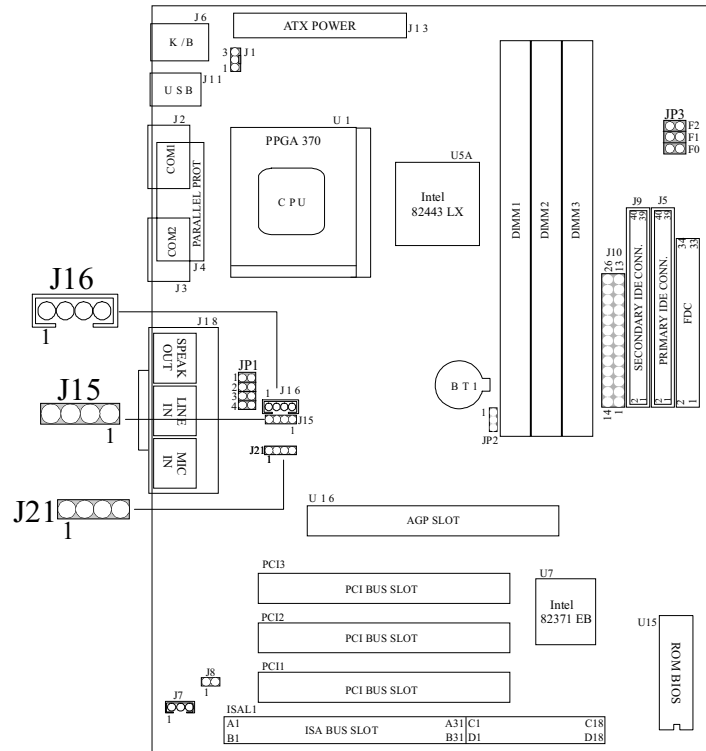

**1.9.1 CD Audio Input Connector (J15)**

Pin No.	Assignment
1	Left Channel Input
2	GND
3	GND
4	Right Channel Input

**1.9.2 CD Audio Input Connector (J16)**

Pin No.	Assignment
1	Left Channel Input
2	GND
3	Right Channel Input
4	GND

**1.9.3 Telephony Connector (J21)**

Pin No.	TAD
1	MONO_IN
2	GND
3	GND
4	MONO_OUT

## 2. AWARD BIOS Setup

### Entering Setup

Power on the computer and press <Del> immediately allowing you to enter Setup. The other way to enter Setup is to power on the Computer, and when the message below appears briefly at the bottom of the screen during the POST (Power On Self Test), press the <Del> key or simultaneously press the <CTRL>, <Alt>, and <Esc> keys.

#### **TO ENTER SETUP BEFORE BOOT PRESS CTRL-ALT-ESC OR DEL KEY**

If the message disappears before you respond and you still wish to enter Setup, restart the system again by turning it OFF then ON or pressing the "RESET" button on the system case. You may also restart by simultaneously pressing the <CTRL>, <Alt>, and <Delete> keys. If you do not press the keys at the correct time and the system does not boot, an error message will be displayed, and you will again be asked to:

**PRESS F1 TO CONTINUE, CTRL-ALT-ESC OR DEL TO ENTER SETUP**

### Main Menu

The on line description of the highlighted setup function is displayed at the bottom of the screen.

### Status Page Setup Menu/Option Page Setup Menu

Press <F1> to pop up a small help window that describes the appropriate keys to use and the possible selections for the highlighted item. To exit the Help Window Press <Esc>.

**Control Keys**

Up arrow	Move to previous item
Down arrow	Move to next item
Left arrow	Move to the item at left
Right arrow	Move to the item at right
Esc key	Main Menu:make a space Quit and do not save changes into CMOS Status Page Setup Menu and Option Page Setup Menu: Exit current page and return to Main Menu
PgUp key	Increase the numeric value or make changes
PgDn key	Decrease the numeric value or make changes
+ key	Increase the numeric value or make changes
- key	Decrease the numeric value or make changes
F1 key	General help, only for Status Page Setup Menu and Option Page Setup Menu
(Shift) F2 key	Change color to one of 16 colors. F2 to select color forward, (Shift) F2 to select color backward
F3 key	Reserved
F4 key	Reserved
F5 key	Restore the previous CMOS value, only for Option Page Setup Menu
F6 key	Load the default CMOS value from BIOS default table, only for Option Page Setup Menu
F7 key	Load the default
F8 key	Reserved
F9 key	Reserved
F10 key	Save all the CMOS changes, only for Main Menu

## 2.1 Main Menu

Once you enter AWARD BIOS CMOS Setup Utility, the Main Menu(**Figure 1**) will appear on the screen. The Main Menu allows you to select an item and press <Enter> to accept or enter its sub-menu.

### ■ Figure 1. Main Menu

ROM PCI/ISA BIOS (xxxxxxxx)  
CMOS SETUP UTILITY  
AWARD SOFTWARE, INC.

<b>STANDARD CMOS SETUP</b>	INTEGRATED PERIPHERALS
BIOS FEATURES SETUP	SUPERVISOR PASSWORD
CHIPSET FEATURES SETUP	USER PASSWORD
POWER MANAGEMENT SETUP	IDE HDD AUTO DETECTION
PNP / PCI CONFIGURATION	SAVE & EXIT SETUP
LOAD SETUP DEFAULTS	EXIT WITHOUT SAVING
Esc : Quit    F5 : Menu in BIOS	↑ ↓ → ← : Select Item
F10 : Save & Exit Setup	(Shift) F2 : Change Color

### Standard CMOS Setup

This setup page includes all the items in a standard compatible BIOS.

### BIOS Features Setup

This setup page includes all the items for the BIOS special enhanced features.

### Chipset Features Setup

This setup page includes all the items of chipset special features.

### **Power Management Setup**

This setup page includes all the items for power management features.

### **PnP / PCI Configuration**

This category specifies the value (in units of PCI bus clocks) of the latency timer for this PCI bus master and the IRQ level for PCI device.

### **Load Setup Defaults**

Chipset defaults indicates the values required by the system for maximum performance. The OEM manufacturer may change to defaults through MODBIN before the binary image burn into the ROM.

### **Integrated Peripherals**

This setup page includes all the items for Integrated Peripherals features.

### **Supervisor Password / User Password**

Change, set, or disable password. It allows you to limit access to the system and Setup, or just to Setup.

### **IDE HDD Auto Detection**

Automatically configure hard disk parameters.

### **Save & Exit Setup**

Save CMOS value changes to CMOS and exit setup.

### **Exit Without Saving**

Abandon all CMOS value changes and exit setup.

## 2.2 Standard CMOS Setup

The items in the Standard CMOS Setup Menu are divided into categories. Each category includes no, one, or more than one setup item. Use the arrow keys to highlight the item and then use the <PgUp> or <PgDn> keys to select the value you want in each item.

### ■ Figure 2. Standard CMOS Setup Menu

ROM PCI/ISA BIOS (xxxxxxx)  
STANDARD CMOS SETUP  
AWARD SOFTWARE, INC.

Date (mm:dd:yy) : Mon, <b>Jun</b> 25 1999									
Time (hh:mm:ss) : 11 : 37 : 30									
HARD DISKS	TYPE	SIZE	CYLS	HEAD	PRECOMP	LANDS	SECTOR	MODE	
Primary Master	: Auto	0	0	0	0	0	0	Auto	
Primary Slave	: Auto	0	0	0	0	0	0	Auto	
Secondary Master	: Auto	0	0	0	0	0	0	Auto	
Secondary Slave	: Auto	0	0	0	0	0	0	Auto	
Drive A	:1.44MB, 3.5 in.								
Drive B	:None								
Video	:EGA/VGA								
Halt On	:All, But Keyboard								
Base Memory	:	0K							
Extended Memory	:	0K							
Other Memory	:	512K							
Total Memory	:	512K							
Esc	:	Quit							
F1	:	Help							
			↑	↓	→	←	: Select Item		
			(Shift) F2			: Change Color			
						PU/PD/+/-:Modify			

## Date

The Date format is <day><month><date><year>.

Day	The day, from Sun to Sat, is determined by the BIOS and is display-only
Date	The date, from 1 to 31 (or the maximum allowed in the month)
month	The month, Jan through Dec
year	The year, from 1994 through 2079

## Time

The time format is <hour><minute><second>. The time is calculated based on the 24-hour military-time clock. For example, 2 p.m. is 14:00:00.

## Hard Disk Type

This categories identifies the types of hard disk(s) that have been installed in the computer. There are 46 predefined types and a user definable type. Type 1 to Type 45 are predefined. Type “User” is user-definable. Type “Auto” is automatically defined by BIOS.

Press <PgUp> or <PgDn> to select a numbered hard disk type or type the number and press <Enter>. Note that the specifications of your drive must match with the drive table. The hard disk will not work properly if you enter improper information for this category. If your hard disk drive type is not listed, you can use Type “User” to define your own drive type manually.

If you select type “User”, related information is asked to be entered for several items. Enter the information directly from the keyboard and press <Enter>. This information should be provided in the documentation from your hard disk vendor or the system manufacturer. Most new drives will also have the parameters given on the label on top of the drive.

<b>CYLN</b>	number of cylinders
<b>HEAD</b>	number of heads
<b>WPCOM</b>	write precompensation
<b>SEC</b>	number of sectors
<b>LBA MODE</b>	type of LBA mode
<b>BLK MODE</b>	type of Block mode
<b>PIO MODE</b>	type of PIO
<b>32BIT MODE</b>	type of 32-Bit transfer mode

If a hard disk has not been installed select “NOT Installed” and press <Enter>.



## Drive A Type/Drive B Type

The category identifies the types of floppy disk drive A / drive B that have been installed in the computer.

None	No floppy drive installed
360K, 5 1/4	5-1/4 inch PC-type standard drive; 360 kilobyte capacity
1.2M, 5 1/4	5-1/4 inch AT-type high-density drive; 1.2 megabyte capacity
720K, 3 1/2	3-1/2 inch double-sided drive; 720 kilobyte capacity
1.44M, 3 1/2	3-1/2 inch double-sided drive; 1.44 megabyte capacity
2.88M, 3 1/2	3-1/2 inch double-sided drive; 2.88 megabyte capacity

## Video

This category selects the type of adapter used for the primary system monitor, and must match your video display card and monitor. Although secondary monitors are supported, you do not have to select the type in Setup.

<b>EGA/VGA</b>	Enhanced Graphics Adapter/Video Graphics Array. For EGA, VGA, SEGA, or PGA monitor adapters.
<b>CGA 40</b>	Color Graphics Adapter, power up in 40 column mode
<b>CGA 80</b>	Color Graphics Adapter, power up in 80 column mode
<b>MONO</b>	Monochrome adapter, includes high resolution monochrome adapters

## Halt On

The category determines whether the computer will stop if an error is detected during power up.

No errors	Whenever the BIOS detects a non-fatal error the system will be stopped and you will be prompted.
All errors	The system boot will not stop for any error that may be detected.
All, But Keyboard	The system boot will not stop for a keyboard error, it will stop for all other errors.
All, But Diskette	The system boot will not stop for a disk error, it will stop for all other errors.
All, But Disk/Key	The system boot will not stop for a keyboard or disk error, it will stop for all other errors.

## Memory

This category is display-only which is determined by POST (Power On Self Test) of the BIOS.

### **Base Memory**

The POST of the BIOS will determine the amount of base (or conventional) memory installed in the system. The value of the base memory is typically 512K for system with 512K memory installed on the motherboard, or 640K for system with 640K or more memory installed on the motherboard.

### **Extended Memory**

The BIOS determines how much extended memory is present during the POST. This is the amount of memory located above 1MB in the CPU's memory address map.

### **Other Memory**

This refers to the memory located in the 640K address space. This is the memory that can be used for different applications. DOS uses this area to load device drivers to keep as much base memory free application programs. The most common use for this area is Shadow RAM.

## 2.3 BIOS Features Setup

**!! WARNING !!** The information about BIOS defaults in the manual (Figure 3.4.5.6.8) is just for reference, please refer to the BIOS installed on board, for update information.

### ■ Figure 3. BIOS Features Setup Menu

ROM PCI/ISA BIOS (xxxxxxx)  
 BIOS FEATURES SETUP  
 AWARD SOFTWARE, INC.

Virus Warning	: Disabled	Video BIOS Shadow	: Enabled
CPU Internal Cache	: Enabled	C8000-CBFFF Shadow	: Disabled
External Cache	: Enabled	CC000-CFFFF Shadow	: Disabled
Quick Power On Self Test	: Enabled	D0000-D3FFF Shadow	: Disabled
Boot From LAN First	: Disabled	D4000-D7FFF Shadow	: Disabled
Boot Sequence	: A,C,SCSI	D8000-DBFFF Shadow	: Disabled
Swap Floppy Drive	: Disabled	DC000-DFFFF Shadow	: Disabled
Boot Up Floppy Seek	: Enabled		
Boot Up NumLock Status	: ON		
Gate A20 Option	: Fast		
Typematic Rate Setting	: Disabled		
Typematic Rate (Chars/Sec)	: 6		
Typematic Delay (Msec)	: 250		
Security Option.	: Setup		
PCI/VGA Palette Snoop	: Disabled		
OS Select For DRAM > 64MB	: Non-OS2		
		ESC : Quit	↑↓→← : Select Item
		F1 : Help	PU/PD/+/- : Modify
		F5 : Old Values	<Shift> F2 : Color
		F7 : Load Setup Defaults	

**Virus Warning**

This category flashes on the screen. During and after the system boot up, any attempt to write to the boot sector or partition table of the hard disk drive will halt the system and an error message will appear. In the mean time, you can run an anti-virus program to locate the problem.

**Disabled** (default)

No warning message to appear when anything attempts to access the boot sector or hard disk partition table.

**Enabled**

Activates automatically when the system boots up causing a warning message to appear when anything attempts to access the boot sector of hard disk partition table.

**CPU Internal Cache****Enabled** (default)

Enable cache

**Disabled**

Disable cache

**External Cache**

Cache memory is additional memory that is much faster than conventional DRAM (system memory). Most, but not all, modern PCs have additional (external) cache memory. When the CPU requests data, the system transfers the requested data from the main DRAM into cache memory, for even faster access by the CPU.

**Enabled** (default)

Enable cache

**Disabled**

Disable cache

**Quick Power On Self Test**

This option enables the level 2 external cache memory.

**Enabled** (default)

Enable quick POST

**Disabled**

Normal POST

**Boot From LAN First**

The BIOS attempts to boot from LAN First. If LAN fails to boot, it should invoke INT18h since this is now the boot recovery rector.

**Disabled** (default)

Boot sequence Normal.

**Enabled**

System will first search for LAN.

**Boot Sequence**

This option determines which drive the computer searches the OS at boot-up. The settings are “A, C, SCSI”, “C, A, SCSI”, “C, CDROM, A”, “CDROM, C, A”, “D, A, SCSI”, “E, A, SCSI”, “F, A, SCSI”, “SCSI, A, C”, “SCSI, C, A” or “C only”, “LS/ZIP, C”, etc.

**The default is “A, C, SCSI”.**

**Swap Floppy Drive**

Switches the floppy disk drive between being designated as A and B.

**Default is Disabled.**

**Boot Up Floppy Seek**

During POST, BIOS will determine if the floppy disk drive installed is 40 or 80 tracks. 360K type is 40 tracks while 720K, 1.2M, and 1.44M are all 80 tracks.

**Enabled** (default)

BIOS searches for the floppy disk drive to determine if it is 40 or 80 tracks. Note that BIOS cannot tell from 720K, 1.2M or 1.44M drive type as they are all 80 tracks.

**Disabled**

BIOS will not search for the type of floppy disk drive by track number. Note that there will not be any warning message if the drive installed is 360K.

**Boot Up NumLock Status**

**On** (default)

Numpad is number keys.

**Off**

Numpad is arrow keys.

**Gate A20 Option**

Gate A20 refers to the way the system addresses memory above 1MB (extended memory). When set to Fast, the system chipset controls Gate A20. When set to Normal, a pin in the keyboard controller controls Gate A20. Setting Gate A20 to Fast improves system speed, particularly with OS/2 and Windows.

**Fast** (default)

**Typematic Rate Setting**

This determines the typematic rate.

**Enabled**

Enable typematic rate and typematic delay programming.

**Disabled (default)**

Disable typematic rate and typematic delay programming. The system BIOS will use default value of these 2 items and the default is controlled by keyboard.

**Typematic Rate (Chars/Sec)****6 (default)**

6 characters per second

**8**

8 characters per second

**10**

10 characters per second

**12**

12 characters per second

**15**

15 characters per second

**20**

20 characters per second

**24**

24 characters per second

**30**

30 characters per second

**Typematic Delay (Msec)**

Choose the length of delay from the time you press a key and the character repeating. (units are mil-sec)

**Security Option**

This category allows you to limit access to the system and Setup, or just to Setup.

**System**

The system will not boot and access to Setup will be denied if the correct password is not entered at the prompt.

**Setup (default)**

The system will boot, but access to Setup will be denied if the correct password is not entered at the prompt.

**PCI/VGA Palette Snoop**

Choose Disabled or Enabled. Some graphic controllers which are not VGA compatible take the output from a VGA controller and map it to their display as a way to provide boot information and VGA compatibility.

However, the color information coming from the VGA controller is drawn from the palette table inside the VGA controller to generate the proper colors, and the graphic controller needs to know what is in the palette of the VGA controller. To do this, the non-VGA graphic controller watches for the Write access to the VGA palette and registers the snoop data. In PCI based systems, where the VGA controller is on the PCI bus and a non-VGA graphic controller is on an ISA bus, the Write Access to the palette will not show up on the ISA bus if the PCI VGA controller responds to the Write.

In this case, the PCI VGA controller should not respond to the Write, it should only snoop the data and permit the access to be forwarded to the ISA bus. The non-VGA ISA graphic controller can then snoop the data on the ISA bus. Unless you have the above situation, you should disable this option.

<b>Disabled</b> (default)	Disables the function.
<b>Enabled</b>	Enables the function.

**OS Selection for DRAM > 64MB**

Allows OS/2 to be used with > 64MB of DRAM. Settings are Non-OS/2 (default) and OS/2. Set to OS/2 if using more than 64MB and running OS/2.

**DEFAULT is Non-OS2.**

**Video BIOS Shadow**

Determines whether video BIOS will be copied to RAM for faster execution.

<b>Enabled</b> (default)	Optional ROM is enabled.
<b>Disabled</b>	Optional ROM is disabled.

**C8000 - CFFFF Shadow / DC000 - DFFFF Shadow**

Determines whether the optional ROM will be copied to RAM for faster execution.

<b>Enabled</b>	Optional ROM is shadowed.
<b>Disabled</b> (default)	Optional ROM is not shadowed.

**Note :** For C8000 - DFFFF option - ROM on PCI BIOS, BIOS will automatically enable the shadow RAM. User does not have to select the item.

## 2.4 Chipset Features Setup

The Chipset Features Setup option is used to change the values of the chipset registers. These registers control most of the system options in the computer.

### ■ Figure 4. Chipset Feature Setup Menu

ROM PCI/ISA BIOS (xxxxxxx)  
CHIPSET FEATURES SETUP  
AWARD SOFTWARE, INC.

Auto Configuration	: <b>Enabled</b>	CPU Host Clock	: Hardware
MA Wait State	: Slow		
DRAM Data Integrity Mode	: Non-ECC		
Video RAM Cacheable	: Disabled		
Memory Hole At 15M-16M	: Disabled		
AGP Aperture Size (MB)	: 64		
SDRAM RAS-to-CAS Delay	: Slow		
SDRAM RAS Precharge Time	: Slow		
SDRAM CAS latency Time	: 3		
		ESC : Quit      ↑ ↓ → ← : Select Item	
		F1 : Help      PU/PD/+/- : Modify	
		F5 : Old Values      <Shift> F2 : Color	
		F7 : Load Setup Defaults	

#### Auto Configuration

Choosing Enabled (default) will automatically Configure Chipset Features Using Default Settings. Choose to customize setup.

#### MA Wait State

Selecting Enabled inserts an wait state before the beginning of a memory read. The setting of this parameter depends on the board design. Do not change form the manufacturer's default unless you are getting memory addressing errors.

**Slow** (default)



**DRAM Data Integrity Mode**

Select Non-ECC or ECC(error-correcting code), according to the type of installed DRAM. The settings are Non-ECC or ECC.

**Non-ECC**

**Video RAM Cacheable**

Same as system BIOS Cacheable.

**Memory Hole At 15M-16M**

Enabling this features reserves 15MB to 16MB memory address space to ISA expansion cards that specifically require this setting. This makes the memory from 15MB and up unavailable to the system. Expansion cards can only access memory up to 16MB. The default is Disabled.

**AGP Aperture Size (MB)**

Select the size of Accelerated Graphics Port(AGP) aperture. The aperture is a portion of the PCI memory address range dedicated for graphics memory address space. Host cycles that hit the aperture range are forwarded to the AGP without any translation.

**The Choices : 4M, 8M, 16M, 32M, 64M, 128M, 256M.**

**SDRAM RAS-to-CAS Delay**

This field lets you insert a timing delay between the CAS and RAS strobe signals, used when DRAM is written to, read from, or refreshed. Fast gives faster performance; and Slow gives more stable performance. This field applies only when synchronous DRAM is installed in the system.

**SDRAM RAS Precharge Time**

If an insufficient number of cycles is allowed for the RAS accumulate its charge before DRAM refresh, the refresh may be incomplete and the DRAM may fail to retain data. Fast gives faster performance; and Slow gives more stable performance. This field applies only when synchronous DRAM is installed in the system.

**SDRAM CAS latency Time**

When synchronous DRAM is installed, the number of clock cycles of CAS latency depends on the DRAM timing. Do not reset this field from the default value specified by the system designer.

**CPU Host Clock**

The settings are Hardware, 66MHz, 68MHz, 75MHz, 83MHz.

**Hardware (default)**

## 2.5 Power Management Setup

□ Figure 5. Power Management Setup Menu

ROM PCI/ISA BIOS (xxxxxxx)  
POWER MANAGEMENT SETUP  
AWARD SOFTWARE, INC.

Power Management	: <b>User Define</b>	** Reload Glodal Timer Events **
PM Control by APM	: Yes	IRW[3-7,9-15],NMI : Enabled
Video Off Method	: DPMS	Primary IDE0 : Enabled
Video Off After	: Standby	Primary IDE1 : Enabled
MODEM Use IRQ	: 3	Secondary IDE0 : Disabled
Doze Mode	: Disabled	Secondary IDE1 : Disabled
Standby Mode	: Disabled	Floppy Disk : Enabled
Suspend Mode	: Disabled	Serial Port : Enabled
HDD Power Down	: Disabled	Parallel Port : Enabled
Throttle Duty Cycle	: 62.5%	Resume by Alarm : Disabled
PCI/VGA Act-Monitor	: Disabled	
Soft-Off by PW-BTTN	: Instant-off	
CPUFAN off In Suspend	: Enabled	
PowerOn on PCI Card	: Disabled	
PowerOn by Ring	: Disabled	
WakeUP On LAN	: Disabled	
IRQ 8 Break Suspend	: Disabled	
		ESC : Quit      ↑↓→← : Select Item
		F1 : Help      PU/PD/+/- : Modify
		F5 : Old Values      <Shift> F2 : Color
		F7 : Load Setup Defaults

**Power Management**

<b>User Define</b>	Users can configure their own power
<b>Min Saving</b>	Pre-defined timer values are used such that all timers are at their MAX value.
<b>Max Saving</b>	Pre-defined timer values are used such that all timers are at their MIN value.

**PM Control by APM**

<b>No</b>	System BIOS will ignore APM when Power Management is on.
<b>Yes (default)</b>	System BIOS will wait for APM's prompt before it enters any PM mode.

**Video Off Method**

<b>Blank Screen</b>	The system BIOS will only blank the screen when disabling video.
<b>V/H SYNC+Blank</b>	In addition to the above, BIOS will also turn off the V-SYNC & H-SYNC signals from VGA card to monitor.
<b>DPMS (default)</b>	This function is enabled only for a VGA card supporting DPMS.

**Video Off After**

The setting are M/A, Standby, Doze, or Suspend. This option is for choosing the setting in which the monitor will turn off.

<b>N/A</b>	Always turn on.
<b>Doze</b>	During Doze mode, the monitor will be turned off.
<b>Standby (default)</b>	During Standby mode, the monitor will be turned off.
<b>Suspend</b>	During Suspend mode, the monitor will be turned off.

The default setting is Standby.

**MODEM Use IRQ**

Set the interrupt request (IRQ) line assigned to the modem (if any) on your system.  
Activity of the selected IRQ always awakens the system.

3 (default)

**Doze Mode**

**Disable (default)**  
**1 Min/2 Min/**  
**4 Min/6 Min/**  
**8 Min/10 Min/**  
**20 Min/30 Min/**  
**40Min/1 Hr**

System will never enter DOZE mode.  
Defines the continuous idle time before the system enters DOZE mode.  
If any item defined in the options of “Power DOWN and Resume events” is enabled & active, DOZE mode, any of the items enabled in “Wake Up Events in Doze and Standby” will trigger the system to wake up.

**Standby Mode**

**Disable (default)**  
**1 Min/2 Min/**  
**4 Min/6 Min/**  
**8 Min/10 Min/**  
**20 Min/30 Min/**  
**40Min/1 Hr**

System will never enter STANDBY mode.  
Defines the continuous idle time before the system enters STANDBY mode.  
If any item defined in the options of “Power DOWN and Resume events” is enabled & active, STANDBY timer will be reloaded. When the system has entered Standby mode, any of the items enabled in “Wake Up Events in Doze and Standby” will trigger the system to wake up.

**Suspend Mode**

**Disable (default)**  
**1 Min/2 Min/**  
**4 Min/6 Min/**  
**8 Min/10 Min/**  
**20 Min/30 Min/**  
**40Min/ 1 Hr**

System will never enter SUSPEND mode.  
Defines the continuous idle time before the system enters SUSPEND mode.  
If any item defined in the options of “Power SUSPEND and Resume events” is enabled & active, SUSPEND timer will be reloaded. When the system has entered SUSPEND mode, any of the items enabled in “Wake Up Events in Doze and Standby” will trigger the system to wake up.

**HDD Power Down**

<b>Disable (default)</b>	HDD's motor will not shut off.
<b>1 Min/2 Min/</b>	Defines the continuous idle time before the HDD enters the power saving mode (motor off). BIOS will turn off the HDD's motor when time is out.
<b>4 Min/6 Min/</b>	
<b>7 Min/8 Min</b>	
<b>9 Min/10 Min/</b>	
<b>11 Min/12 Min/</b>	
<b>13 Min/14 Min/</b>	
<b>15 Min</b>	

**Throttle Duty Cycle**

This option will determine how much power will be used by the CPU, if the system goes into suspend mode.

**PCI/VGA Act-Monitor**

During Enabled, if there's no activity in the monitor screen the system will go into Power Saving Mode. During Disabled, the system will go into Power Saving Mode, whether there is activity in the monitor screen or not. The settings are Disabled and Enabled.

**Soft-Off by PW-BTTN**

This item allows you to set the off function of power button by software control.

**Instant-Off (default)**

**CPUFAN off In Suspend**

The default value is Enabled.

<b>Disabled</b>	Disable this function.
<b>Enabled (default)</b>	Stop CPU FAN when entering Suspend mode.

**PowerOn on PCI Card**

To use function, you need PCI card which support power on functions. It can control power status from PCI device.

**PowerOn by Ring**

An input signal on the serial Ring Indicator (RI) line (in other words, an incoming call on the modem) awakens the system from a soft off state.

**Wake Up On LAN**

To use function, you need a LAN add-on card which support power on functions. It should also support the wake-up LAN jumper

**Disabled** (default)      Wake Up On LAN not supported.

**IRQ 8 Break Suspend**

<b>IRQ[3-7,9-15], NMI</b>	: Enabled
<b>Primary IDE 0</b>	: Enabled
<b>Primary IDE 1</b>	: Enabled
<b>Secondary IDE 0</b>	: Disabled
<b>Secondary IDE 1</b>	: Disabled
<b>Floppy Disk</b>	: Enabled
<b>Serial Port</b>	: Enabled
<b>Parallel Port</b>	: Enabled

**Resume by Alarm**

This function is for setting date and time for your computer to boot up. During Disabled, you cannot use this function.

## 2.6 PNP / PCI Configuration Setup

■ Figure 6. PNP / PCI Configuration Setup Menu

ROM PCI/ISA BIOS (xxxxxxxx)  
 PNP / PCI FUNCTION SETUP  
 AWARD SOFTWARE, INC.

PNP OS Installed	: <b>No</b>	PCI IDE IRQ Map To	: ISA
Resources Controlled BY	: Manual	Assign IRQ For VGA	: Enabled
Reset Configuration Data	: Disabled	Assign IRQ For USB	: Enabled
IRQ-3 assigned to	: PCI / ISA PnP		
IRQ-4 assigned to	: PCI / ISA PnP		
IRQ-5 assigned to	: PCI / ISA PnP		
IRQ-7 assigned to	: PCI / ISA PnP		
IRQ-9 assigned to	: PCI / ISA PnP		
IRQ-10 assigned to	: PCI / ISA PnP		
IRQ-11 assigned to	: PCI / ISA PnP		
IRQ-12 assigned to	: PCI / ISA PnP		
IRQ-14 assigned to	: PCI / ISA PnP		
IRQ-15 assigned to	: PCI / ISA PnP		
DMA-0 assigned to	: PCI / ISA PnP		
DMA-1 assigned to	: PCI / ISA PnP	ESC : Quit	↑ ↓ → ← : Select Item
DMA-3 assigned to	: PCI / ISA PnP	F1 : Help	PU/PD/+/- : Modify
DMA-5 assigned to	: PCI / ISA PnP	F5 : Old Values	<Shift> F2 : Color
DMA-6 assigned to	: PCI / ISA PnP	F7 : Load Setup Defaults	
DMA-7 assigned to	: PCI / ISA PnP		



**PnP OS Installed**

When set to YES, BIOS will only initialize the PnP cards used for booting (VGA, IDE, SCSI). The rest of the cards will be initialized by the PnP operating system like Windows™95. When set to NO, BIOS will initialize all the PnP cards. Therefore for non-PnP operating system (DOS, Netware™), this option must be set to "NO".

**Resources Controlled By "Auto" or "Manual"**

By Choosing "Auto" the system BIOS will detect the system resource and automatically assign the relative IRQ and DMA channel for each peripheral.

By Choosing "Manual"(default), the user will need to assign IRQ & DMA for add-on cards. Be sure that there are no IRQ/DMA and I/O port conflicts.

**Reset Configuration Data**

The system BIOS supports the PnP feature so the system needs to record which resource is assigned and protect resources from conflict. Every peripheral device has a node which is called ESCD. This node records which resources are assigned to it. The system needs to record and update ESCD to the memory locations. These locations (4K) are reserved at the system BIOS.

If Disabled (default) is chosen, the system's ESCD will update only when the new configuration varies from the last one.

If Enabled is chosen, the system is forced to update ESCDs and then is automatically set to the "Disabled" mode.

IRQ-3	assigned to : PCI / ISA PnP
IRQ-4	assigned to : PCI / ISA PnP
IRQ-5	assigned to : PCI / ISA PnP
IRQ-7	assigned to : PCI / ISA PnP
IRQ-9	assigned to : PCI / ISA PnP
IRQ-10	assigned to : PCI / ISA PnP
IRQ-11	assigned to : PCI / ISA PnP
IRQ-12	assigned to : PCI / ISA PnP
IRQ-14	assigned to : PCI / ISA PnP
IRQ-15	assigned to : PCI / ISA PnP
DMA-0	assigned to : PCI / ISA PnP
DMA-1	assigned to : PCI / ISA PnP
DMA-3	assigned to : PCI / ISA PnP
DMA-5	assigned to : PCI / ISA PnP
DMA-6	assigned to : PCI / ISA PnP
DMA-7	assigned to : PCI / ISA PnP

The above settings will be shown on the screen only if “Manual” is chosen for the Resources Controlled By function.

Legacy is the term which signifies that a resource is assigned to the ISA Bus and provides for non PnP ISA add-on cards. PCI / ISA PnP signifies that a resource is assigned to the PCI Bus or provides for ISA PnP add-on cards and peripherals.

### **PCI IDE IRQ Map TO**

<b>PCI-Auto :</b>	This setting is for off-board PCI IDE card and is full compatible with PCI specifications.
<b>PCI-Slot 1-4 :</b>	This setting is for off-board PCI IDE card is not full compatible with PCI specifications. You must specify which PCI slot PCI IDE Card is installed in.
<b>ISA :</b>	This setting is used if the off-board PCI IDE card uses an edge trigger and IRQ routes directly to the ISA Bus

### **Assign IRQ For VGA**

Lets the user choose which IRQ to assign for VGA card.

### **Assign IRQ For USB**

Lets the user choose which IRQ to assign for USB.

## 2.7 Load Setup Defaults

Chipset defaults indicate the values required by the system for maximum performance.

### ■ Figure 8. Load SETUP Defaults Screen

ROM PCI/ISA BIOS (xxxxxxx)  
CMOS SETUP UTILITY  
AWARD SOFTWARE, INC.

STANDARD CMOS SETUP	INTEGRATED PERIPHERALS
BIOS FEATURES SETUP	SUPERVISOR PASSWORD
CHIPSET FEATURES SETUP	USER PASSWORD
POWER MANA	CTION
PCI & PCI CON	TUP
LOAD SETUP D	NG
<b>Load SETUP Defaults (Y/N) ? N</b>	
Esc : Quit    F5 : Menu in BIOS	↑ ↓ → ← : Select Item
F10 : Save & Exit Setup	(Shift) F2 : Change Color
Load SETUP Defaults except Standard CMOS SETUP	

If you wish to load the SETUP Defaults, change the prompt to <Y> and press <ENTER>.

## 2.8 Integrated Peripherals Setup

### ■ Figure 9. Integrated Peripherals Setup Menu

ROM PCI/ISA BIOS (xxxxxxxx)  
INTEGRATED PERIPHERALS  
AWARD SOFTWARE, INC.

IDE HDD Block Mode	: Enabled	Onboard Parallel Port	: 378/IRQ7
IDE Primary Master	PIO : Auto	Parallel Port Mode	: SPP
IDE Primary Slave	PIO : Auto	OnBoard Sound Chip	: Enabled
IDE Secondary Master	PIO : Auto		
IDE Secondary Slave	PIO : Auto		
IDE Primary Master	UDMA : Auto		
IDE Primary Slave	UDMA : Auto		
IDE Secondary Master	UDMA : Auto		
IDE Secondary Slave	UDMA : Auto		
On-Chip Primary PCI IDE	: Enabled		
On-Chip Secondary PCI IDE	: Enabled		
USB Keyboard Support	: Disabled		
Onboard FDC Controller	: Enabled		
Onboard Serial Port1	: 3F8/IRQ4		
Onboard Serial Port2	: 2F8/IRQ3		
UART 2 Mode	: Standard		
		ESC : Quit      ↑ → ↓ ← : Select Item	
		F1 : Help      PU/PD/+/- : Modify	
		F5 : Old Values    <Shift> F2 : Color	
		F7 : Load Setup Defaults	

#### **IDE HDD Block Mode**

This allows your hard disk controller to use the fast block mode to transfer data to and from your hard disk drive (HDD).

**IDE Primary / Secondary Master / Slave PIO**

The IDE PIO (Programmed Input / Output) fields let you set a PIO mode (0-4) for each of the IDE devices that the onboard IDE interface supports. Modes 0 through 4 provide successively increased performance. In Auto mode, the system automatically determines the best mode for each device.

**Auto** (default)

**IDE Primary / Secondary Master / Slave UDMA**

Ultra DMA /33 implementation is possible only if your IDE hard drive supports it and the operating environment includes a DMA drive (Windows 95 OSR2 or a third party IDE bus master driver). If your hard drive and your system software both support Ultra DMA/33, select Auto to enable BIOS support.

**On-Chip Primary PCI IDE**

As stated above, your system includes two built-in IDE controllers, both of which operate on the PCI bus. This setup item allows you either to enable or disable the primary controller. You might choose to disable the controller if you were to add a higher performance or specialized controller.

**On-Chip Secondary PCI IDE**

As above for the Primary controller, this setup item you either to enable or disable the secondary controller. You might choose to disable the controller if you were to add a higher performance or specialized controller.

**USB Keyboard Support**

Select Enabled if your system contains a Universal Serial Bus (USB) controller and you have a USB Keyboard.

**The choices: Enabled, Disabled**

**Onboard FDC Controller**

**Enabled/Disabled** The system has an on-board Super I/O chip with a FDD controller that supports 2 FDDs for 360K/720K/1.2M/1.44M/2.8M. Choose "Enabled" to use the on-board FDD controller for accessing the FDD. Otherwise choose "Disabled" to use the off-board FDD controllers.

**Onboard Serial Port 1**

**Disabled / (3F8 / IRQ4) / (2F8 / IRQ3) / (3E8 / IRQ4) / (2E8 / IRQ3)**

**Onboard Serial Port 2****Disabled / (3F8 / IRQ4) / (2F8 / IRQ3) / (3E8 / IRQ4) / (2E8 / IRQ3)**

The system has an Onboard Super I/O chipset with 2 serial ports.

The Onboard serial ports can be selected as:

**Disabled**

3F8 / IRQ4 COM1 uses IRQ4

2F8 / IRQ3 COM2 uses IRQ3

3F8 / IRQ4 COM3 uses IRQ4

2F8 / IRQ3 COM4 uses IRQ3

**UART 2 Mode**

This item allows you to determine which Infra Red (IR) function of onboard I/O chip.

**The Choices : Standard ASKIR, HPSIR.****Onboard Parallel Port**

This item allows you to determine access onboard parallel port controller with which I/O address.

**The choices : 378/IRQ7, 278/IRQ5, 3BC/IRQ7, Disabled.****Parallel Port Mode**

Select an operating mode for the onboard parallel (printer) port. Normal EPP (Extended Parallel Port) ECP (Extended Capabilities Port) CEP+EPP PC AT parallel port Bi-directional port Fast, buffered port Fast, buffered, bi-directional port.

Select Normal unless you are certain your hardware and software both support EPP or ECP mode.

**The choices : SPP, EPP1.9+SPP, ECP, ECP+EPP1.9, Normal, EPP1.7+SPP, ECP+EPP1.7.****Onboard Sound chip**

This item allows you determine to use the function of PCI Sound chip built on board.

**Disabled****Enabled (default)**

## 2.9 Supervisor / User Password Setting

### ■ Figure 9. Supervisor Password Setting

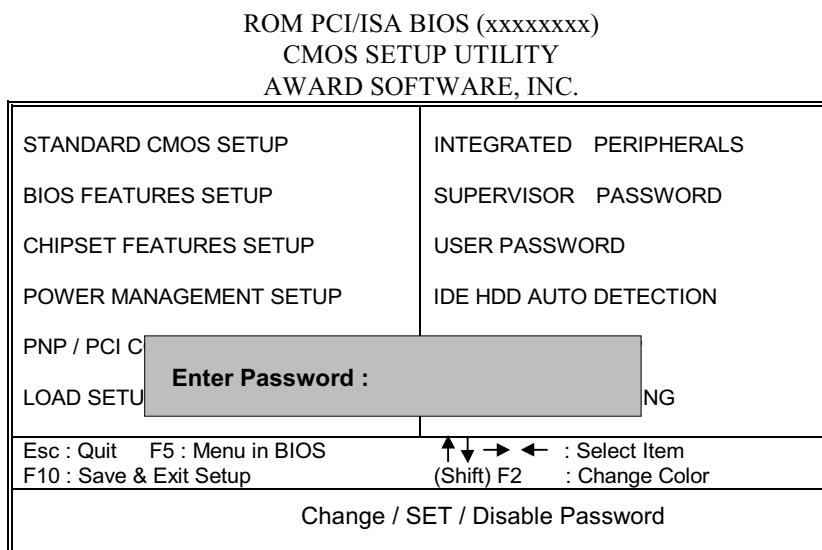

When you select this function, the following message will appear at the center of the screen to assist you in creating a password.

#### ENTER PASSWORD

Type the password, up to eight characters, and press <Enter>. The password you type now will clear any previously entered password from CMOS memory. You will be asked to confirm the password. Type the password again and press <Enter>. You may also press <ESC> to abort the selection and not enter a password. To disable password, just press <Enter> when you are prompted to enter password. A message will confirm that you wish to disable the password. Once the password is disabled, the system will boot and you can enter setup freely.

#### PASSWORD DISABLED

If you select "System" at the Security Option of BIOS Features Setup Menu, you will be prompted for the password every time the system is rebooted or any time you try to enter Setup. If you select "Setup" at Security Option of BIOS Feature Setup Menu, you will be prompted only when you try to enter Setup.

## 2.10 IDE HDD Auto Detection

Automatically configure hard disk parameters. The parameters shown below are only examples.

■ **Figure 10. Auto Configuration with Optimal Settings Screen**

ROM PCI/ISA BIOS (xxxxxxx)  
CMOS SETUP UTILITY  
AWARD SOFTWARE, INC.

HARD DISKS	TYPE	SIZE	CYLS	HEAD	PRECOMP	LAND	SECTOR	MODE
Primary Master :	User	343	665	16	65535	664	63	NORMAL

Select Primary Slave Option (N=Skip) N							
OPTIONS	SIZE	CYLS	HEAD	PRECOMP	LANDZ	SECTOR	MODE
1(Y)	0	0	0	0	0	0	NORMAL

Note : Some OSes (like SCO-UNIX) must use "NORMAL" for installation

| ESC : Skip |

When you enter this utility, the screen asks you to select a specific hard disk for Primary Master. If you accept a hard disk detected by the BIOS, you can enter "Y" to confirm and then press <Enter> to check next hard disk. This function allows you to check four hard disks and you may press the <Esc> after the <Enter> to exit this function and go back to the Main Menu.



## 2.11 Save & Exit Setup

Save CMOS value changes to CMOS and exit setup.

### ■ Figure 11. Save & Exit Setup Screen

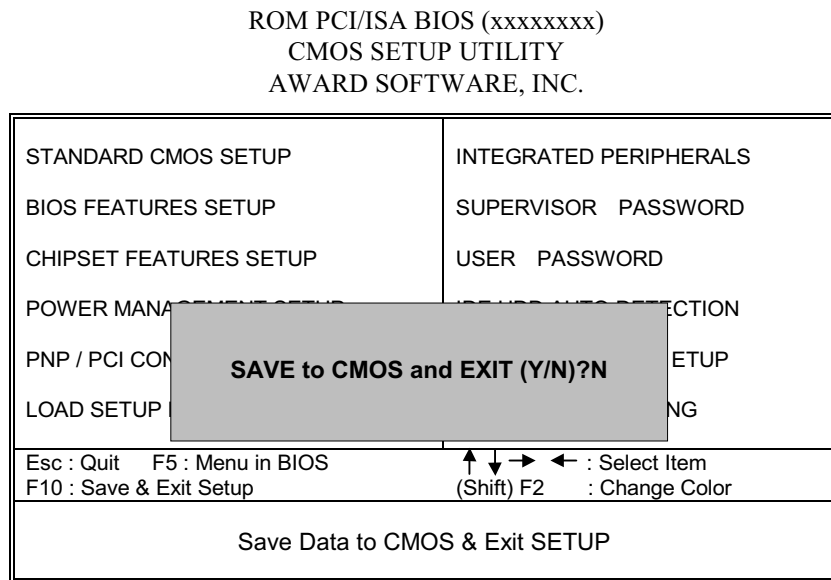

Pressing <N> and <ENTER> will return you to the Main Menu.

Pressing <Y> and <ENTER> will save the system parameters and continue with the booting process.

## 2.12 Exit Without Saving

Abandon all CMOS value changes and exit setup.

■ **Figure 12. The Save Settings and Exit Screen**

ROM PCI/ISA BIOS (xxxxxxx)  
 CMOS SETUP UTILITY  
 AWARD SOFTWARE, INC.

STANDARD CMOS SETUP	INTEGRATED PERIPHERALS
BIOS FEATURES SETUP	SUPERVISOR PASSWORD
CHIPSET FEATURES SETUP	USER PASSWORD
POWER MANAGEMENT	FUNCTION
PNP / PCI CONFIGURATION	
LOAD SETUP DEFAULTS	LOADING
<b>Quit Without Saving (Y/N)?N</b>	
Esc : Quit    F5 : Menu in BIOS	↑ ↓ → ← : Select Item
F10 : Save & Exit Setup	(Shift) F2 : Change Color
Abandon All Data & Exit SETUP	

Pressing <N> and <ENTER> will return you to the Main Menu.

Pressing <Y> and <ENTER> will continue with booting process without saving any system parameters.

## 2.13 Application Software

- Please use the "BIOS Utility" diskette to setup Flash Memory.
- The diskette contains the intelligent installation utility **AWDFLASH.EXE**, displayed below.

■ **Figure 13. Flash Memory Writer**

FLASH MEMORY WRITER Vxx	
Copyright (C) 1992-1994 Award Software, Inc.,	
For xx-xxxxxxxxxxxxxxxxxxxx	DATE: xx/xx/xxxx
Flash Type -	
File Name to Program:	<input type="text"/>
+	
Error Message :	Do You Want To Save Bios (Y/N)?

## 3 Software

### 3.1 Motherboard Software

**NOTE: The mark \* means it can be installed directly from CD by using CD Installation Utility ( i.e. START.EXE).**

#### 3.1.1 Software List

Category	Description	Platform	Location in CD
HighPoint XStore Pro *	Install the drivers to support Ultra DMA mode Hard Drive.	Windows 95/98	\XStore
Intel Bus Master IDE Drivers *	Install the drivers to support Ultra DMA mode Hard Drive.	Windows NT4.0	\Ide
NS LM78+61 Software * (Optional)	National Semiconductor LM78+LM61 Software for monitoring voltages, temperature, fan speed.	Windows 95/98	\Sysdiag\Lm7x_61
Award Flash Utility	Used for updating BIOS. (Please refer to chapter - Application Software.)		\Flash

### 3.1.2 Software Installation

There is an installation wizard, Driver CD Installation Utility (START.EXE), located in the root of Driver CD to let users install some common used drivers conveniently.

➤ **The drivers can be installed from CD by using CD Installation Utility:**

You can simply put Driver CD into CD-ROM drive and the Installation Utility will autorun or you can run the Driver CD Installation Utility directly by using mouse cursor to click the proper option on the page. Utility will invoke other applications to complete the rest of installation.

➤ **The drivers CAN NOT be installed directly from CD by using CD Installation Utility:**

Please read the README.TXT located in the root directory on Multimedia CD to get drivers' location and then refer to the INSTALL.TXT or README.TXT files located in each driver directory on the Driver CD to install drivers.

### 3.1.3 Using Software

- In general, you can get more detailed information in the on-line help or readme for the softwares.

- **Using NS LM78+61 Software (Optional)**

After the utility is installed, you can double click the “LM7x\_61” shortcut on the screen to invoke the utility.

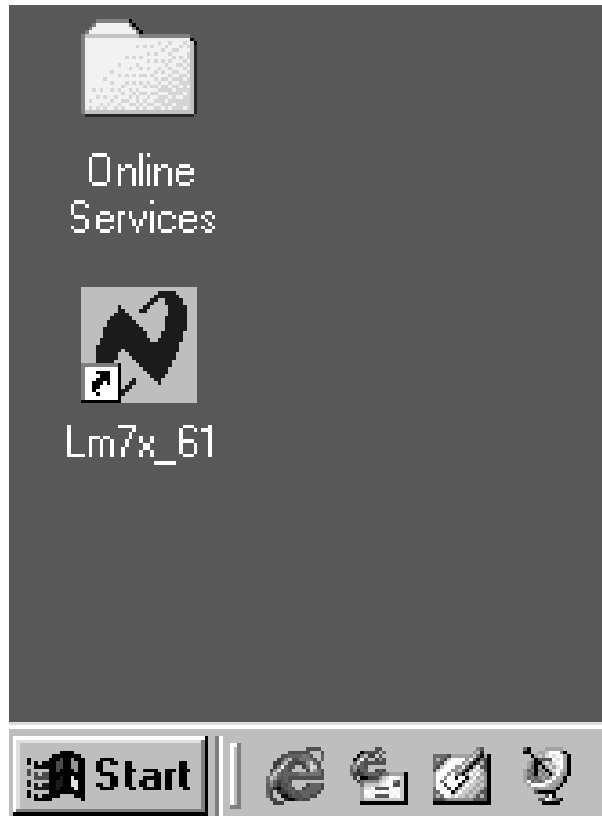

The following figure is the main panel of NS LM78+61 Software. In the panel, you can get some real-time and important information -- Voltage, Fan speed, and temperature, for example. If there is an abnormal situation, you can resolve it immediately.

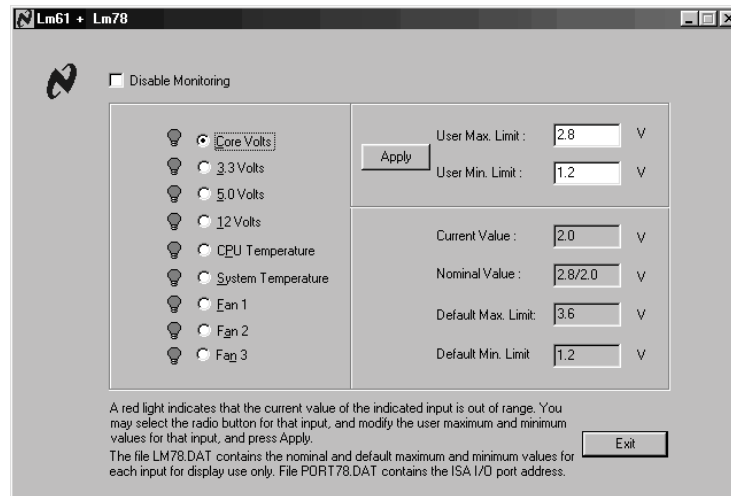

## 3.2 ESS Solo-1 (on-board) Software

### 3.2.1 Software List

#### Drivers

Category	Location in CD
Windows 95 / 98	\Solo1\Win9x
Windows NT 4.0	\Solo1\WinNT40

#### Applications

Name	Location in CD	Platform
AudioRack 32	\Solo1\Arakp311	Windows 95 / 98



### 3.2.2 Software Installation

There is an installation wizard, **Driver CD Installation Utility** (START.EXE), located in the root of the CD to let users install drivers directly and conveniently.

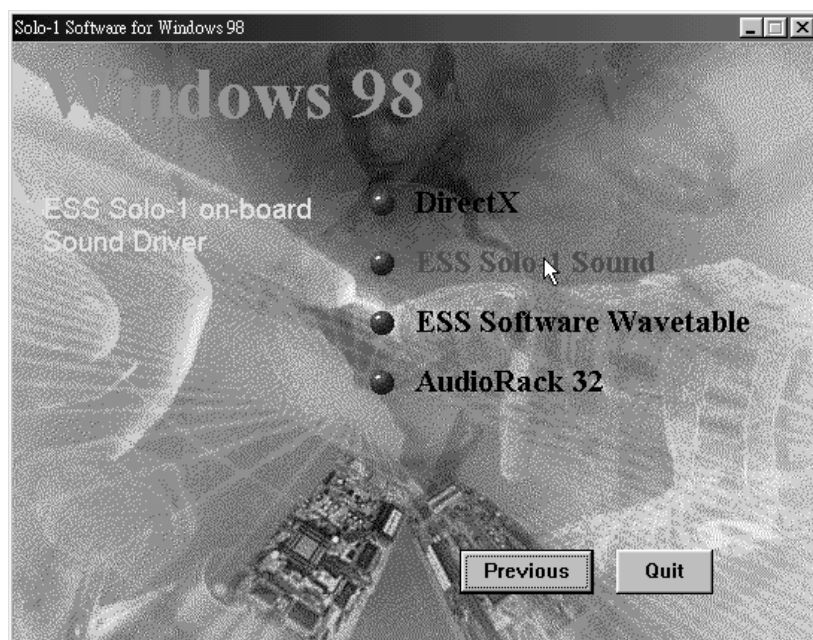

### 3.2.3 Using Software

#### • Using AudioRack 32

After the AudioRack 32 Software Installation completed, please refer to Readme.txt and On-line Help come with AudioRack 32 for the detailed information before using AudioRack 32.



## 4. Trouble Shooting

### **PROBLEM**

No power to the system at all. Power light does not illuminate, fan inside power supply does not turn on. Indicator light on keyboard does not turn on.

<b>PROBABLE CAUSE</b>	<b>DIAGNOSIS</b>	<b>SOLUTION</b>
Power cable is unplugged.	Visually inspect power cable	Make sure power cable is securely plugged in
Defective power cable.	Visual inspection, try another cable.	Replace cable.
Power supply failure.	Power cable and wall socket are OK, but system is still dead.	Contact technical support.
Faulty wall outlet; circuit Breaker or fuse blown.	Plug in device known to work in socket and test	Use different socket, repair outlet, reset circuit breaker or replace fuse.

**PROBLEM**

System inoperative. Keyboard lights are on, power indicator lights are lit, hard drive is spinning.

<b>PROBABLE CAUSE</b>	<b>DIAGNOSIS</b>	<b>SOLUTION</b>
Expansion card is partially dislodged from expansion slot on the motherboard.	Turn off computer. Take cover off system unit. Check all expansion cards to ensure they are securely seated in slots.	Using even pressure on both ends of the expansion card, press down firmly on expansion card.
Defective floppy disk drive or tape drive.	Turn system off. Disconnect the cables from one of the floppy drives. Turn on the floppy drives. Turn on the system, check to see if the keyboard operates normally. Repeat until you have located defective unit.	Contact Technical Support.
Defective expansion card.	Turn computer off. Remove an expansion card	Make sure expansion card is secure in expansion socket.

**PROBLEM**

System does not boot from hard disk drive, can be booted from floppy disk drive.

<b>PROBABLE CAUSE</b>	<b>DIAGNOSIS</b>	<b>SOLUTION</b>
Connector between hard drive and system board unplugged.	When attempting to run the FDISK utility described in the HARD DISK section of this manual you get a message, INVALID DRIVE SPECIFICATION.	Check cable running from disk to disk controller board. Make sure both ends are securely plugged in; check the drive type in the Standard CMOS Setup (see HARD DISK section of this manual).
Damaged Hard Disk or Disk Controller.	Format hard disk; if unable to do so the hard disk may be defective.	Contact Technical Support.
Hard Disk directory or FAT is scrambled.	Run the FDISK program, format the hard drive (see HARD DRIVE section of manual). Copy data that was backed up onto Hard Drive.	Backing up the hard drive is extremely important. All Hard Disk are capable of breaking down at any time.

**PROBLEM**

System only boots from floppy Disk. Hard disk can be read and applications can be used but booting from Hard Disk is impossible.

<b>PROBABLE CAUSE</b>	<b>DIAGNOSIS</b>	<b>SOLUTION</b>
Hard Disk boot program has been destroyed.	A number of causes could be behind this.	Back up data and applications files. Reformat the Hard Drive as described in the Hard Drive section of this manual. Re-install applications and data using backup disks.

**PROBLEM**

Error message reading "SECTOR NOT FOUND" or other error messages not allowing certain data to be retrieved.

<b>PROBABLE CAUSE</b>	<b>DIAGNOSIS</b>	<b>SOLUTION</b>
A number of causes could be behind this.	Use a file by file backup instead of an image backup in order to backup the Hard Disk.	Back up any salvageable data. Then low level format, partition, and high level format the hard drive (see Hard Disk section of this manual for instructions). Re-install all saved data when completed.

**PROBLEM**

Disk formatted on IBM PS/2 will not operate with this system.

<b>PROBABLE CAUSE</b>	<b>DIAGNOSIS</b>	<b>SOLUTION</b>
The IBM PS/2 uses a different format than other computers.	IBM PS/2 disk format will not work in an AT type computer.	Format disk in the AT type computer insert disk into the IBM PS/2 and copy the files you wish.

**PROBLEM**

After installing an expansion card (network card, tape drive card, etc.) the system no longer works properly.

<b>PROBABLE CAUSE</b>	<b>DIAGNOSIS</b>	<b>SOLUTION</b>
No power to monitor.	All or part of the system may be inoperable. The new card may work but a mouse or COM port may not work	Change the interrupt or RAM address on the new expansion card. See the documentation that came with the new card in order to change pin settings. Many expansion devices come with proprietary software that will assist you in doing this.

**PROBLEM**

Screen message says "Invalid Configuration" or "CMOS Failure."

<b>PROBABLE CAUSE</b>	<b>DIAGNOSIS</b>	<b>SOLUTION</b>
Incorrect information entered into the configuration (setup) program.	Check the configuration program. Replace any incorrect information.	Review system's equipment . Make sure correct information is in setup.

**PROBLEM**

Screen is blank.

<b>PROBABLE CAUSE</b>	<b>DIAGNOSIS</b>	<b>SOLUTION</b>
No power to monitor.		Check the power connectors to monitor and to system. Make sure monitor is connected to display card, change I/O address on network card if applicable
Monitor not connected to computer.		See instructions above.
Network card I/O address conflict.		See instructions above.

**PROBLEM**

<b>PROBABLE CAUSE</b>	<b>DIAGNOSIS</b>	<b>SOLUTION</b>
Memory problem, display card jumpers not set correctly.		Reboot computer. Reinstall memory, make sure that all memory modules are installed in correct sockets. Check jumper and switch settings on display card. See display card section for information on settings.
Computer virus.		Use anti-virus programs (McAfee, E-Prot, etc) to detect and clean viruses.

**PROBLEM**

Screen goes blank periodically.

<b>PROBABLE CAUSE</b>	<b>DIAGNOSIS</b>	<b>SOLUTION</b>
Screen saver is enabled.		Disable screen saver.

**PROBLEM**

Keyboard failure.

<b>PROBABLE CAUSE</b>	<b>DIAGNOSIS</b>	<b>SOLUTION</b>
Keyboard is disconnected.		Reconnect keyboard. Check keys again, if no improvement replace keyboard.



**PROBLEM**

No color on screen.

<b>PROBABLE CAUSE</b>	<b>DIAGNOSIS</b>	<b>SOLUTION</b>
Faulty Monitor.		If possible, connect monitor to another system. If no color replace monitor.
CMOS incorrectly set up.		Call technical support.

**PROBLEM**

Floppy drive light stays on.

<b>PROBABLE CAUSE</b>	<b>DIAGNOSIS</b>	<b>SOLUTION</b>
Floppy Drive cable not connected correctly.		Reconnect floppy cable making sure PIN1 on the Floppy Drive corresponds with PIN1 on Floppy cable connector.

**PROBLEM**

Error reading drive A:

<b>PROBABLE CAUSE</b>	<b>DIAGNOSIS</b>	<b>SOLUTION</b>
Bad floppy disk.		Try new floppy disk
Floppy disk not formatted		Format floppy disk (type FORMAT A: type ENTER)>

**PROBLEM**

C: drive failure.

<b>PROBABLE CAUSE</b>	<b>DIAGNOSIS</b>	<b>SOLUTION</b>
SETUP program does not have correct information.		Boot from drive A: using DOS system disk. Input correct information to SETUP program.
Hard Drive cable not connected properly.		Check Hard Drive cable.

**PROBLEM**

Cannot boot system after installing second hard drive.

<b>PROBABLE CAUSE</b>	<b>DIAGNOSIS</b>	<b>SOLUTION</b>
Master/Slave jumpers not set correctly.		Set Master/Slave jumpers correctly.
Hard Drives not compatible / different manufacturers.		Run SETUP program and select correct drive types. Call Drive manufacturers for compatibility with other drives.

**PROBLEM**

Missing operating system on hard drive.

<b>PROBABLE CAUSE</b>	<b>DIAGNOSIS</b>	<b>SOLUTION</b>
CMOS setup has been changed.		Run setup and select correct drive type.

**PROBLEM**

Certain keys do not function.

<b>PROBABLE CAUSE</b>	<b>DIAGNOSIS</b>	<b>SOLUTION</b>
Keys jammed or defective.		Replace keyboard.

**PROBLEM**

Keyboard is locked, no keys function.

<b>PROBABLE CAUSE</b>	<b>DIAGNOSIS</b>	<b>SOLUTION</b>
Keyboard is locked.		Unlock keyboard

03/01/1999  
MADE IN TAIWAN  
R.O.C