

---

## **Federal Communications Commission (F.C.C) Statement**

This device complies with Part 15 of the FCC Rules. Operation of this device is subject to the following two conditions: (1) this device may not cause harmful interference, and (2) this device must accept any interference received, including interference that may cause undesired operation.

Accessories: This device has been tested and found to comply with the limits of a Class B digital device, the accessories associated with this equipment are as follows:

1. Shielded serial cable. (Can be obtained from multiple retail outlets)
2. Shielded printer cable. (Can be obtained from multiple retail outlets)
3. Shielded video cable. (Can be obtained from multiple retail outlets)
4. Shielded power cord. (Provided by manufacturer)

These accessories are required to be used in order to ensure compliance with FCC Rules. It is the responsibility of the user to provide and use these accessories properly.

This equipment has been tested and found to comply with the limits of a Class B digital device, pursuant to Part 15 of the FCC Rules. These limits are designed to provide reasonable protection against harmful interference in a residential installation. This equipment generates, uses and can radiate radio frequency energy and, if not installed and used in accordance with the instructions, may cause harmful interference to radio communications. However, there is no guarantee that interference will not occur in a particular installation. If this equipment does cause harmful interference to radio or television reception, which can be determined by turning the equipment off and on, the user is encouraged to try to correct the interference by one or more of the following measures:

1. Reorient / Relocate the receiving antenna.
  2. Increase the separation between the equipment and receiver.
  3. Connect the equipment into an outlet on a circuit different from that to which the receiver is connected.
-

---

4. Consult the dealer or an experienced radio/TV technician for help.

Caution: Changes or modifications not expressly approved by the manufacturer could void the user's authority to operate the equipment.

## **Disclaimer**

The Vendor makes no representations or warranties with respect to the contents here of and specially disclaims any implied warranties of merchantability or fitness for any purpose. Further the Vendor reserves the right to revise this publication and to make changes from time to time in the contents here of without obligation to notify any party beforehand. Duplication of this publication, in part or in whole, is not allowed without first obtaining the Vendor's approval in writing.

## **Trademarks and Remarks**

MS-DOS, Windows, Windows NT, and Windows 9x are products of Microsoft Corp, with its ownership of trademark, and are distributed by the Vendor under a license agreement.

All trademarks used in this manual are the property of their respective owners.

Copyright(C) 1992  
All Rights Reserved

## **Canadian D.O.C. Statement**

This digital apparatus does not exceed the Class B limits for radio noise emissions from digital apparatus as set out in the radio interference regulations of the Canadian Department of Communications.

Cet appareil numérique n'émet pas de bruits radioélectriques dépassant les limites appliqués aux appareils numériques de Class B prescrits dans le règlement du brouillage radioélectrique édicté par le ministère Des Communications du Canada.

---

## **Contents**

---

<b>Introduction .....</b>	<b>1-1</b>
<b>1 Motherboard Description .....</b>	<b>1-2</b>
1.1 Features .....	1-2
1.1.1 Hardware .....	1-2
1.1.2 Software .....	1-6
1.1.3 Attachments .....	1-6
1.2 Motherboard Installation .....	1-7
1.2.1 Layout of Motherboard .....	1-7
1.3 Motherboard Connectors .....	1-8
1.3.1 Front Panel Connectors (J20) .....	1-9
1.3.2 ATX 20-pin Power Connector (J4) .....	1-12
1.3.3 Hard Disk Connectors (J10/J11) .....	1-13
1.3.4 Floppy Disk Connector (J12) .....	1-13
1.4 Back Panel Connectors .....	1-14
1.4.1 PS/2 Mouse / Keyboard Connector (J2) .....	1-14
1.4.2 USB Connectors (J5/J3) .....	1-15
1.5 Serial and Parallel Interface Ports .....	1-17
1.6 CPU Installation .....	1-22
1.6.1 CPU Installation Procedure .....	1-22
1.7 Jumper Settings .....	1-23
1.7.1 CPU Fan Connector (J1) .....	1-24
1.7.2 Sound AC'97 CODEC Selection (J19) .....	1-24

## **Contents**

---

1.7.3 System Fan Connector (J21) (Optional).....	1-24
1.7.4 INTRUDER Connector (J25).....	1-24
1.7.5 USB Location Selection (JP1).....	1-25
1.7.6 Manufacture Setting (JP4).....	1-25
1.7.7 Wake-On-LAN Connector (JP14).....	1-25
1.7.8 FWH (BIOS) Lock/Unlock Connector (JP17) .....	1-25
1.7.9 CMOS Function Selection (JP20) .....	1-26
1.7.10 Keyboard/Mouse power Selection (JKV1).....	1-26
1.8 DRAM Installation.....	1-27
1.8.1 DIMM .....	1-27
1.8.2 Installation.....	1-28
1.9 Audio Subsystem.....	1-29
1.9.1 CD Audio-In Connectors (CD_IN1/JCD_IN2).....	1-29
1.9.2 Telephony Connector (JP11).....	1-30
1.9.3 AUX Audio in Connector (AUX_IN) .....	1-30
1.10 LCD Daughter Card Subsystem (Optional).....	1-31
1.10.1 Features .....	1-31
1.10.2 Installation.....	1-33
1.11 MR Card Subsystem (Optional).....	1-34
1.11.1 Features .....	1-34
1.11.2 Installation.....	1-35
<b>2. BIOS Setup.....</b>	<b>2-1</b>
2.1 Main Menu.....	2-3

## **Contents**

---

2.2 Standard CMOS Features.....	2-5
2.3 Advanced BIOS Features.....	2-8
2.4 Advanced Chipset Features.....	2-12
2.5 Integrated Peripherals .....	2-16
2.6 Power Management Setup.....	2-21
2.7 PnP/PCI Configurations.....	2-26
2.8 Frequency Control.....	2-29
2.9 M/B Diagnosis (Optional).....	2-30
2.10 Load Fail-Safe Defaults .....	2-31
2.11 Load Optimized Defaults .....	2-32
2.12 Set Supervisor/User Password .....	2-33
2.13 Save & Exit Setup.....	2-35
2.14 Exit Without Saving.....	2-36
<b>3 Software.....</b>	<b>3-1</b>
3.1 Software .....	3-1
3.1.1 Software List .....	3-1
3.1.2 Software Installation.....	3-2
3.1.3 Software Usage.....	3-4
<b>4. Trouble Shooting .....</b>	<b>4-1</b>

## Introduction

### System Overview

Thanks for buying this product! This manual was written to help you start using this product as quickly and smoothly as possible. Inside you will find adequate explanations to solve most problems. In order for this reference material to be of greatest use, refer to the “expanded table of contents” to find relevant topics.

This board incorporates the all new Intel® 810 serial chipset, built-in UMA AGP VGA, the LPC I/O, and PCI IDE into one board that provides a total PC solution. The motherboard, a Celeron™ processor based PC/Micro ATX system, supports a 128KB or 256KB cache on CPU, PCI Local Bus to support upgrades to your system performance. On-Board sound subsystem to support high 3D sound quality, the AMR slot to support the solution of high performance, low cost modem. It is ideal for multi-tasking and fully supports MS-DOS, Windows 3x, Windows NT, Windows 2000, Novell, OS/2, Windows9x, UNIX, SCO UNIX etc. This manual also explains how to install the motherboard for operation, and how to setup your CMOS configuration with the BIOS setup program.

# 1 Motherboard Description

## 1.1 Features

### 1.1.1 Hardware

#### CPU

- The Celeron™ processor (PPGA) the new generation power for high-end workstations and servers.
- Provides Socket 370.
- Running at 66 MHz Front Side Bus frequency.

#### Speed

- Supports from 300MHz to 550MHz CPU core speeds.
- Supports 33MHz PCI Bus speed.

#### DRAM Memory

- Supports three 8/16/32/64/128/256MB DIMM module sockets.
- Supports Synchronous DRAM (3.3V).
- Supports a maximum memory size of 512 MB with SDRAM.
- 100MHz Bus frequency.

#### Shadow RAM

- A memory controller that provides shadow RAM.

#### Green Function

- Supports power management operation via BIOS.
- Power down timer from 1 min to 1 Hour.
- Wakes up by any key pressed or mouse activity.
- Wake On LAN connector.
- Wake On MODEM header.
- S3 (suspend to RAM) support.
- Wake On AMR supported.

**BUS Slots**

- Provides one AMR slot and three PCI Bus slots.
- One TV/DFP expansion connector.

**PCI Enhanced IDE Built-in Onboard**

- Supports 4 IDE hard disk drives.
- Supports PIO mode 4, Master Mode high performance hard disk drives.
- Supports Ultra DMA/33 and Ultra DMA/66 (Optional) Bus Master Mode.
- Supports IDE interface with CD-ROM.
- Supports high capacity hard disk drives.
- Supports LBA mode.
- Driver detected by BIOS.

**PCI-Based AC 97 Digital Audio Processor (Optional)**

- AC 97 2.1 interface.
- 16 channels of high-quality sample rate conversion.
- 16x8 channel digital mixer.
- Stereo 10 band graphic equalizer.
- Sound Blaster® and Sound Blaster Pro® emulation.
- S/PDIF output (allows standard interface to consumer electronics).
- 64-voice wavetable.
- PC99 complaint and WHQL certified.

**AC'97 Sound Codec Onboard***AC'97 2.1 FEATURES.*

- Variable Sample Rate.
- True Line-Level Output.

*AC'97 FEATURES.*

- Multibit Converter Architecture for Improved S/N Ratio greater than 90dB.
  - 16-Bit stereo Full-Duplex Codec.
    - Four Analog Line-Level Stereo Inputs for Connection from LINE, CD, AUX and TAD.
  - Two Analog Line-Level Mono Inputs for Speakerphone and PC BEEP.
-



- Mono MIC Input.
- High Quality CD Input with Ground Sense.
- Stereo Line Level Output.
- Mono Output for speakerphone.
- Mobile Low Power Mixer Mode.
- Digital Audio Mixer Mode.
- DSP 16-Bit Serial Port Format.
- Full Duplex Variable 7 KHz to 48 KHz Sampling Rate with 1 Hz Resolution.
- Phat™ Stereo Chancement.
- Extended 6-Bit Master Volume Control Audio Amp Power Down Signal.

#### **LPC I/O Built-in Onboard**

- LPC Interface.
- PC98, PC99 Compliant.
- Game Port Interface.
- MPU-401 MDI Support.
- Intelligent Auto Power Management.
- 2.88MB Super I/O Floppy Disk Controller.
- Floppy Disk Available on Parallel Port Pins.
  - Supports 360KB, 720KB, 1.2MB, 1.44MB, and 2.88MB floppy disk drives.
- Enhanced Digital Data Separator.
- Serial Ports.
  - Two full Function Serial Ports.
  - Supports 230K and 460K Baud Programmable Baud Rate Generator Modem Control Circuitry.
- Infrared Port.
- Multi-Mode™ Parallel Port with ChipProtect™.

**Integrated 2D/3D graphics accelerator**

- Integrated 24-bit 230MHz RAM DAC.
- H/W Motion Compensation Assistance for S/W MPEG2 Decode.
- Optional 4MB Display Cache.
- Optional TVout/ Flat Panel Display Interface support.

**Hardware Monitor Subsystem**

The hardware monitor subsystem provides low-cost instrumentation capabilities. The features of the hardware monitor subsystem include:

- Management Level 4 functionality.
- Microprocessor System Hardware Monitor:
  - Integrated temperature and voltage monitoring to detect levels above or below acceptable values (+12V, -12V, +5V, +3.3V, VCCORE). When suggested ratings for temperature, fan speed, or voltage are exceeded, an interrupt is activated.
- Fan speed sensors.
- Access through the SMBus.
- Remote reset capabilities from a remote peer.

**System Speed Selection**

- Front side bus frequency may be selected by both jumper setting and the BIOS.

**Universal Serial Bus**

- Supports two Universal Serial Bus (USB) Ports.
- Supports 48MHz USB.
- Port1 usb may be located to either rear panel or front panel.

**Dimension (Micro ATX form-factor)**

- 20.8cm X 24.4 cm (W x L)

## 1.1.2 Software

### BIOS

- AWARD BIOS.
- ACPI Supported.
- Supports APM1.2.
- Supports USB Function.
- Setting the CPU Host frequency/Ratio.

### Operating Systems

- Offers the highest performance for MS-DOS, OS/2, Windows 3x, Windows NT, Windows 2000, Windows 9x, Novell, UNIX, SCO UNIX etc.

## 1.1.3 Attachments

- HDD Cable.
- FDD Cable.
- Rear I/O Panel for ATX Case (Optional).
- COM2 Cable (Optional).
- CD for sound, VGA, IDE drivers and modem driver utilities.
- Cable for Digital Flat Panne Port or TV output port (Optional).
- TV/LCD (DFP) adapter card (Optional).
- AMR Card (Optional).
- Front USB cable (Optional).

## 1.2 Motherboard Installation

### 1.2.1 Layout of Motherboard

Model No.M6TWC VER: 1.0 and afterwards

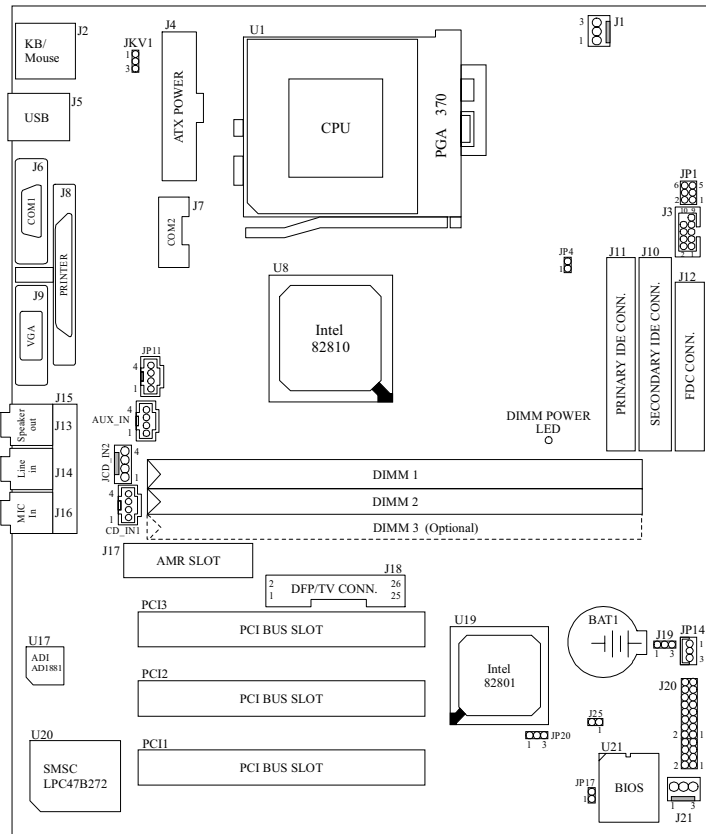

**Note: JKV1 for P.C.B Ver. 1.1 and afterwards.**

## 1.3 Motherboard Connectors

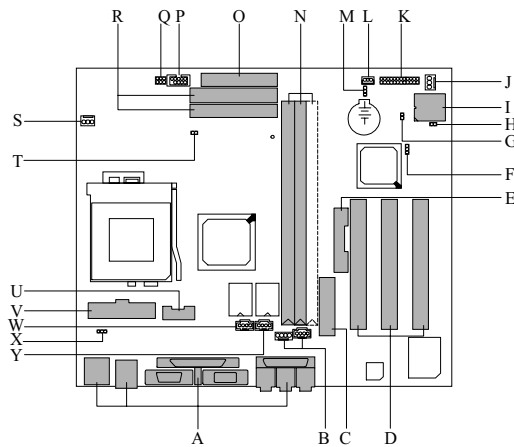

- |   |  |
|---|--|
| <b>A.</b> Back panel I/O connectors                   | <b>N.</b> DIMMs socket (DIMM1-3)                   |
| <b>B.</b> CD Audio-In connectors<br>(CD_IN1/ JCD_IN2) | <b>O.</b> FDD connector (J12)                      |
| <b>C.</b> AMR Slot (J17)                              | <b>P.</b> Front USB connector (J3)                 |
| <b>D.</b> PCI BUS Slots (PCI1-3)                      | <b>Q.</b> USB location Selection (JP1)             |
| <b>E.</b> Digital Video connector (J18)               | <b>R.</b> IDE connectors (J10-11)                  |
| <b>F.</b> CMOS Function Selection (JP20)              | <b>S.</b> CPU Fan connector (J1)                   |
| <b>G.</b> INTRUDER connector (J25)                    | <b>T.</b> Manufacture Setting (JP4)                |
| <b>H.</b> FWH Lock/Unlock conn. (JP17)                | <b>U.</b> COM2 connector (J7)                      |
| <b>I.</b> Firmware Hub (U21)                          | <b>V.</b> ATX Power connector (J4)                 |
| <b>J.</b> System Fan connector (J21)                  | <b>W.</b> Telephony connector (JP11)               |
| <b>K.</b> Front Panel connector (J20)                 | <b>X.</b> KEYBOARD by power on<br>connector (JKV1) |
| <b>L.</b> Wake-On LAN connector (JP14)                | <b>Y.</b> AUX Audio in CONN. (AUX_IN)              |
| <b>M.</b> Sound CODEC Selection (J19)                 |  |

**Note: JKV1 for P.C.B Ver. 1.1 and afterwards.**

### 1.3.1 Front Panel Connectors (J20)

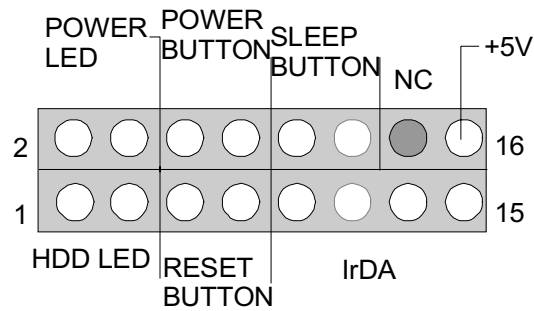

Pin No.	Assignment	Function	Pin No.	Assignment	Function
1	HDD LED (+)	Hard Drive LED	2	Power LED (+)	Power LED
3	HDD LED (-)		4	Power LED (-)	Power LED
5	Ground	Reset button	6	Power Button	Power Button
7	Reset control		8	Ground	Power Button
9	+5V	IrDA Connector	10	Sleep Control	Sleep Button
11	Ir-IN		12	Ground	Sleep Button
13	Ground		14	No Connection	No Connection
15	Ir-out		16	+5V	No Connection

### PC Speaker (Optional)

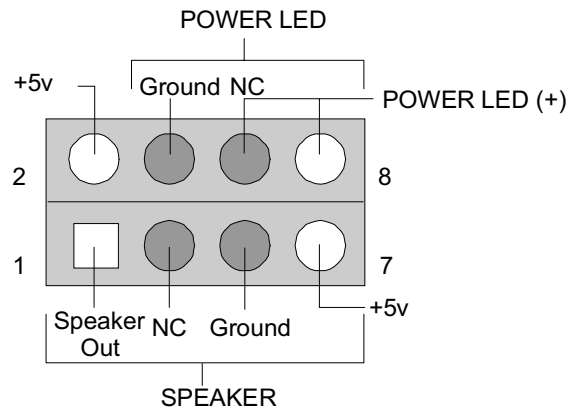

Pin No.	Assignment	Function	Pin No.	Assignment	Function
1	Speaker	PC Speaker Connector	2	+5V	VCC
3	NC		4	Ground	POWER LED
5	Ground		6	POWER LED (+)	
7	+5V		8		

### Speaker Connector

An offboard speaker can be installed on the motherboard as a manufacturing option. An offboard speaker can be connected to the motherboard at the front panel connector. The speaker (onboard or offboard) provides error beep code information during the Power On Self-Test when the computer cannot use the video interface. The speaker is not connected to the audio subsystem and does not receive output from the audio subsystem.

**Reset Button**

This connector can be connected to a momentary SPST type switch that is normally open. When the switch is closed, the motherboard resets and runs the POST.

**Power LED Connector**

This connector can be connected to an LED that will light when the computer is powered on.

**Hard Drive LED Connector**

This connector can be connected to an LED to provide a visual indicator that data is being read from or written to a hard drive. For the LED to function properly, an IDE drive must be connected to the onboard hard drive controller.

**Infrared Connector**

After the IrDA interface is configured, files can be transferred from or to portable devices such as laptops, PDAs, and printers using application software.

**Sleep Button**

When APM is enabled in the system BIOS, and the operating system's APM driver is loaded, the system can enter sleep (standby) mode in one of the following ways.

**Power On Button**

This connector can be connected to a front panel power switch. The switch must pull the Power Button pin to ground for at least 50 ms to signal the power supply to switch on or off. (The time requirement is due to internal denounce circuitry on the motherboard.) At least two seconds must pass before the power supply will recognize another on/off signal.



### 1.3.2 ATX 20-pin Power Connector (J4)

This connector supports the power button on-board. Using the ATX power supply, functions such as Modem Ring Wake-Up and Soft Power Off are supported on this motherboard. This power connector supports instant power-on functionality, which means that the system will boot up instantly when the power connector is inserted on the board.

PIN	VOLTAGE	PIN	VOLTAGE
1	3.3 V	11	3.3 V
2	3.3 V	12	-12 V
3	GND	13	GND
4	5 V	14	PS_ON
5	GND	15	GND
6	5 V	16	GND
7	GND	17	GND
8	PW_OK	18	-5 V (Optional)
9	5V_SB	19	5 V
10	12 V	20	5 V

*Warning: Since the motherboard has the instant power on function, make sure that all components are installed properly before inserting the power connector to ensure that no damage will be done.*

### 1.3.3 Hard Disk Connectors (J10/J11)

The motherboard has a 32-bit Enhanced PCI IDE Controller that provides PIO Mode 0-4, Bus Master, and Ultra DMA / 33 or 66 functionality. It has two HDD connectors IDE1 (primary) and IDE2 (secondary). You can connect up to four hard disk drives, a CD-ROM, a 120MB Floppy (reserved for future BIOS) and other devices to IDE1 and IDE2. These connectors support the IDE hard disk cable provided.

- **J11 (Primary IDE Connector)**

The first hard drive should always be connected to IDE1. IDE1 can connect a Master and a Slave drive. You must configure the second hard drive on IDE1 to Slave mode by setting the jumper accordingly.

- **J10 (Secondary IDE Connector)**

The IDE2 controller can also support a Master and a Slave drive. The configuration is similar to IDE1. The second drive on this controller must be set to slave mode.

### 1.3.4 Floppy Disk Connector (J12)

The motherboard provides a standard floppy disk connector (FDC) that supports 360K, 720K, 1.2M, 1.44M and 2.88M floppy disk types. This connector supports the provided floppy drive ribbon cables.

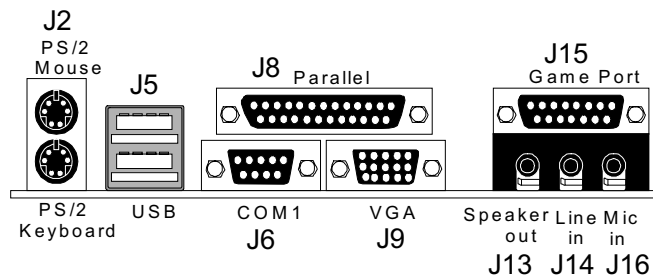

## 1.4 Back Panel Connectors

### 1.4.1 PS/2 Mouse / Keyboard Connector (J2)

The motherboard provides a standard PS/2 mouse / Keyboard mini DIN connector for attaching a PS/2 mouse. You can plug a PS/2 mouse / Keyboard directly into this connector. The connector location and pin definition are shown below:

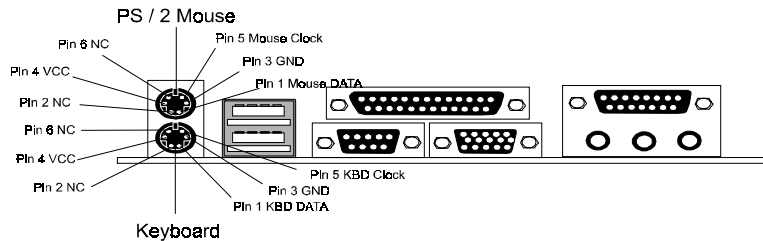

#### PS/2 Mouse / Keyboard Connectors

Pin	Signal Name
1	Data
2	No connect
3	Ground
4	+5 V (fused)

5	Clock
6	No connect

### 1.4.2 USB Connectors (J5/J3)

The motherboard provides a UHCI (Universal Host Controller Interface) Universal Serial Bus roots for attaching USB devices such as: keyboard, mouse and other USB devices. You can plug the USB devices directly into this connector.

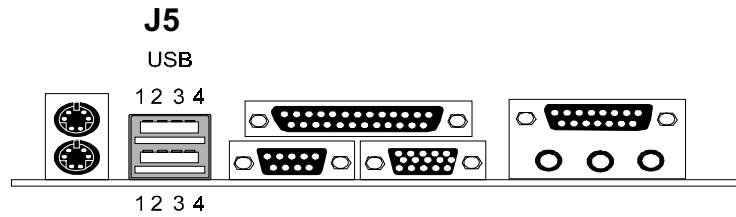

#### Stacked USB Connectors

Pin	Signal Name
1	+5 V (fused)
2	USBP0- [USBP1-]
3	USBP0+ [USBP1+]
4	Ground

**Note:** (1) Signal names in brackets ([ ]) are for USB port 1.  
(2) Please see the setting description of JP1 for detail USB function selection.

### Front USB Connector (J3)

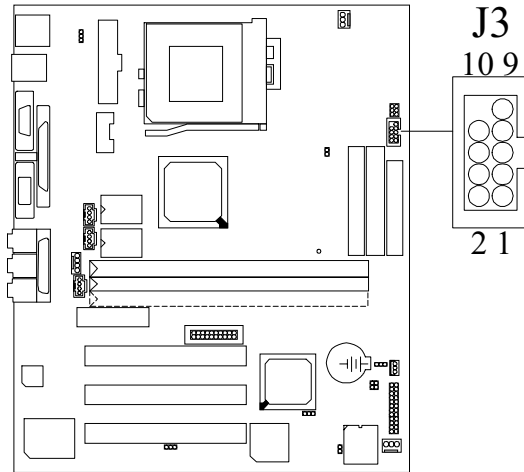

Pin	Signal Name	Pin	Signal Name
1	N/C	2	+5V
3	Ground	4	NC
5	NC	6	FNT_USBP0
7	Ground	8	FNT_USBP0#
9	Ground	10	Key

**Note:** Please see the setting description of JP1 for detail USB function selection.

## 1.5 Serial and Parallel Interface Ports

This system comes equipped with two serial ports and one parallel port. Both types of interface ports will be explained in this chapter.

### The Serial Interface Port-I : COM1

The serial interface port is sometimes referred to as an RS-232 port or an asynchronous communications port. Mice, printers, modems and other peripheral devices can be connected to a serial port. The serial port can also be used to connect your computer with another computer system. If you wish to transfer the contents of your hard disk to another system it can be accomplished by using each machine's serial port.

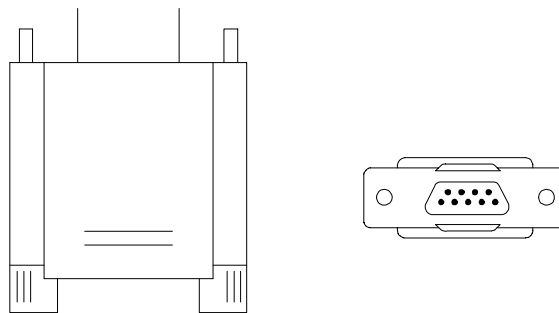

The serial ports on this system have two 9-pin connector. Some older computer systems and peripherals used to be equipped with only one 25-pin connector. Should you need to connect your 9-pin serial port to an older 25-pin serial port, you can purchase a 9-to-25 pin adapter.

**Connectivity**

The serial port can be used many ways, and it may be necessary to become familiar with the pin-out diagram. The following chart gives you the function of each pin on the 9-pin connector and some of the 25-pin connector. This information can be used when configuring certain software programs to work with the serial port.

<b>Signal</b>	<b>Name</b>	<b>DB9 PIN</b>	<b>DB25 PIN</b>
DCD	Data Carrier Detect	1	8
RX	Receive Data	2	3
TX	Transmit Data	3	2
DTR	Data Terminal Ready	4	20
GND	Signal Ground	5	7
DSR	Data Set Ready	6	6
RTS	Request to Send	7	4
CTS	Clear to Send	8	5
RI	Ring Indicator	9	22

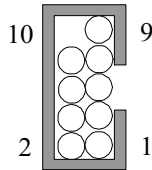
**The Serial Interface Port-II : COM2**

Signal	Name	IDC PIN
DCD	Data Carrier Detect	1
RX	Receive Data	2
TX	Transmit Data	3
DTR	Data Terminal Ready	4
GND	Signal Ground	5
DSR	Data Set Ready	6
RTS	Request to Send	7
CTS	Clear to Send	8
RI	Ring Indicator	9

**Special Applications**

There are two types of serial devices that can be connected to a serial port. One of the devices is called "DTE" (Data Terminal Equipment) and the other device is called "DCE" (Data Communications Equipment). If a modem is connected to a computer, for example, the modem is called the DCE and the computer is called the DTE. In situations such as this, the pins on the serial ports can be connected straight through.

In instances when there are two DTE devices connected together, such as a computer and a printer, a special adapter called a "Null Modem" is needed to make communication between the two devices possible.

When using the serial port to communicate between devices, one problem in particular may arise. Some manufacturers use one set of signals to begin communication with another device and other manufacturers do not use these



signals to initiate communication. If you encounter a communication problem that cannot be resolved using a null modem, it can generally be assumed that one device is using the initialization signals and the other device is not. This can usually be resolved by wiring the RTS, CTS, and DCD pins together.

### **Serial Ports/COM Ports**

The two serial ports on the computer are called COM1 and COM2, respectively. If you wish, two more serial ports can be added onto the computer using optional hardware. Should you choose to add the extra Serial ports (COM ports) they would be called COM3 and COM4.

When using serial ports to communicate with a peripheral device, be sure to assign only one COM port number to each device. For example, if a printer and a scanner are both connected to your computer through serial ports, the printer must be assigned one COM port (i.e. COM1) and the scanner must be assigned the other COM port (i.e. COM2). No two devices can be assigned to one COM port. Each peripheral must have its own COM port.

NOTE: Four serial ports may be installed on the computer. However, no more than two ports can be used simultaneously.

\*If you have installed an internal modem, be careful not to assign a COM port number that has already been assigned to another device. This error is common.

When installing a device that is going to require the use of a serial port, use a diagnostic program to find out which ports are available. It may be necessary to remove expansion cards that have serial ports in order to check their jumper settings. The jumper settings will indicate which COM port the card has been assigned. Checking the expansion card will eliminate mistakes in overlapping COM ports. Once you have completed the installation of peripheral devices using the serial ports, be sure that the communication parameters such as baud rate, parity bit, etc. are matching. If your computer is set for a baud rate of 9600 and your modem is set for a baud rate of 2400 you will not be able to send messages. The manuals that accompany the peripheral devices will inform you on the procedure for setting their parameters. Software manuals also have instructions on setting parameters.

**Parallel Interface Port (J8)**

Unlike the serial port, parallel interface ports have been standardized and should not present any difficulty interfacing peripherals to your system. Sometimes called a Centronics port, the parallel port is almost exclusively used with printers. The parallel port on your system has a 25-pin, DB5 connector (see picture below). The pin-out for the parallel port are shown in the table below.

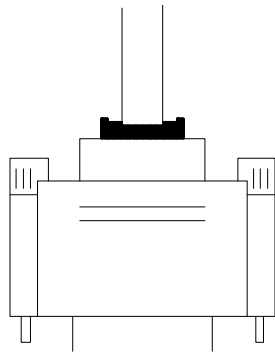
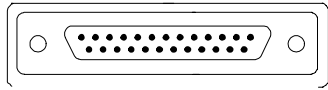

Signal	Pin
-Strobe	1
Data 0	2
Data 1	3
Data 2	4
Data 3	5
Data 4	6
Data 5	7
Data 6	8
Data 7	9
-Ack	10
Busy	11
Paper Empty	12
+Select	13
-Auto FDXT	14
-Error	15
-Init	16
-SLCTN	17
Ground	18
Ground	19
Ground	20
Ground	21
Ground	22
Ground	23
Ground	24
Ground	25

## 1.6 CPU Installation

### 1.6.1 CPU Installation Procedure

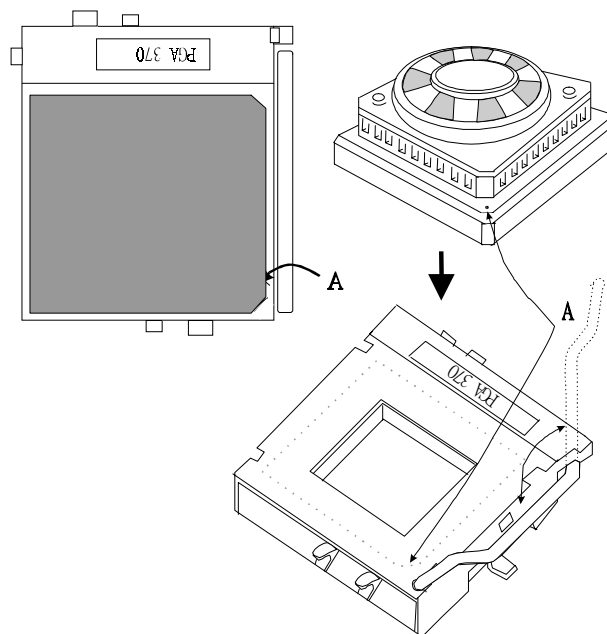

1. Pull the lever sideways away from the socket then raise the lever up to a 90-degree angle.
2. Locate Pin A in the socket and look for the white dot or cut edge in the CPU. Match Pin A with the white dot/cut edge then insert the CPU.
3. Press the lever down to complete the installation.

## 1.7 Jumper Settings

The jumper a two or more pins which may be covered by a plastic jumper cap, allowing you to select different system options.

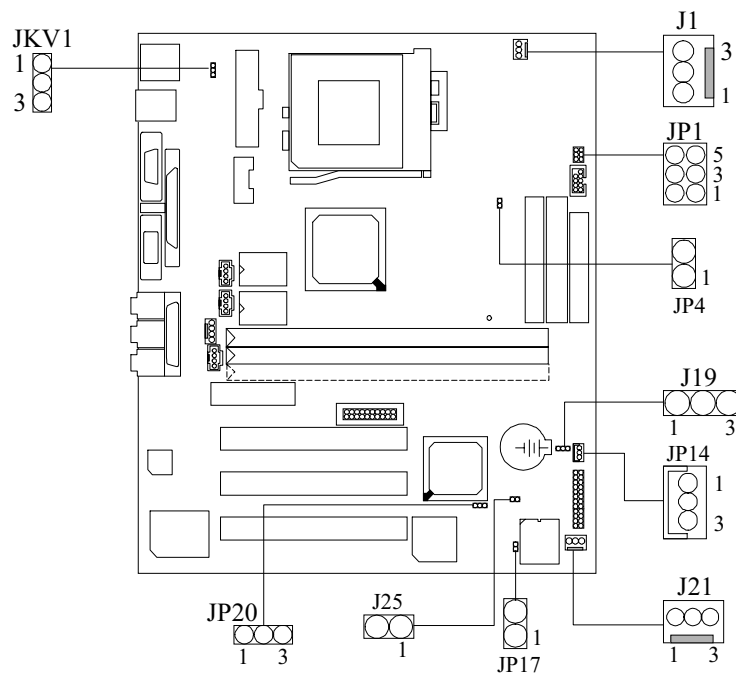

**Note: JKV1 for P.C.B Ver. 1.1 and afterwards.**

### 1.7.1 CPU Fan Connector (J1)

Pin No.	Assignment
1	Control Signal
2	+12V
3	Sense Input

### 1.7.2 Sound AC'97 CODEC Selection (J19)

Pin No.	Signal Name
1-2	On-Board CODEC Selected
2-3	On Riser card CODEC Selected
OPEN	When U23 monted with AU8810

**Note:** Please also setting the CODEC device on AMR card to "Primary" when U23 is mounted with AU8810.

### 1.7.3 System Fan Connector (J21) (Optional)

Pin No.	Assignment
1	Control Signal
2	+12V
3	Senser Input

### 1.7.4 INTRUDER Connector (J25)

Pin No.	Signal Name
1	Input Signal
2	Ground

### 1.7.5 USB Location Selection (JP1)

Pin No.	Signal Name
1-3, 2-4 Closed	Front USB Connector Selected ※Note
3-5, 4-6 Closed	Rear USB Connector Selected

*Note: The up Layer USB Port of J5 (rear USB) is disabled when the front USB selected.*

### 1.7.6 Manufacture Setting (JP4)

Pin No.	Assignment
Open	Default



### 1.7.7 Wake-On-LAN Connector (JP14)

Pin No.	Assignment
1	+ 5V Standby Voltage
2	Ground
3	Wakeup Signal Input

### 1.7.8 FWH (BIOS) Lock/Unlock Connector (JP17)

Pin No.	Assignment
Open	BIOS Boot Block write Inhibited
Closed	BIOS Boot Block Writeable

### 1.7.9 CMOS Function Selection (JP20)

JP20	Assignment
1  3 1-2 Closed	Normal Operation (default)
1  3 2-3 Closed	Clear CMOS Data

### 1.7.10 Keyboard/Mouse power Selection (JKV1)

Pin No.	Assignment
1-2	+5VSB
2-3	+5V

**Note:** JKV1 for P.C.B Ver. 1.1 and afterwards.

## 1.8 DRAM Installation

### 1.8.1 DIMM

DRAM Access Time: 3.3V Unbuffered PC 100 SDRAM required.

DRAMType:8MB/16MB/32MB/64MB/128MB/256MB DIMM Module (168pin)

Total Memory Size (MB)	Bank 0	Bank 1
	DIMM 1/Double-Sided	DIMM 2/Double-Sided
8 M	8M x 1 pc	----
16 M	16M x 1 pc	----
32 M	32M x 1 pc	----
64 M	64M x 1 pc	----
128 M	128M X 1pc	----
16 M	8M x 1 pc	8M x 1 pc
24 M	16M x 1 pc	8M x 1 pc
40 M	32M x 1 pc	8M x 1 pc
72 M	64M x 1 pc	8M x 1 pc
136 M	128M x 1 pc	8M x 1 pc
24 M	8M x 1 pc	16M x 1 pc
32 M	16M x 1 pc	16M x 1 pc
48 M	32M x 1 pc	16M x 1 pc
80 M	64M x 1 pc	16M x 1 pc
144 M	128M x 1 pc	16M x 1pc
40 M	8M x 1 pc	32M x 1 pc
48 M	16M x 1 pc	32M x 1 pc
64 M	32M x 1 pc	32M x 1 pc
96 M	64M x 1 pc	32M x 1 pc
160 M	128M x 1 pc	32M x 1pc
72 M	8M x 1 pc	64M x 1 pc
80 M	16M x 1 pc	64M x 1 pc
96 M	32M x 1 pc	64M x 1 pc
128 M	64M x 1 pc	64M x 1 pc
192 M	128M x 1 pc	64M x 1pc
256 M	128M x 1 pc	128M x 1pc



512 M	256M x 1 pc	256M x 1pc
-------	-------------	------------

### 1.8.2 Installation

According to the limit of the maximum of 2 DIMM sockets with Double-Sided DIMM, we provide the special configuration, which allows you to use 2 single-sided DIMMs to implement the feature of Double-Sided DIMM completely.

How to installation the DIMM3 (Optional)			
	DIMM1	DIMM2	DIMM3 (Optional)
<b>DIMM Type</b>	DS	DS	X
	DS	SS	X
	SS	DS	X
	SS	SS	X
	DS	SS	SS
	SS	SS	SS
	X	X	SS
	X	SS	X
	SS	X	X
	DS	X	X
	X	DS	X

DS: Double Side DIMM.  
SS: Single Side DIMM.  
X: Don't Stuff.

**Note: Don't stuff or remove the DIMM memory, If the LED1 is lighting.**

## 1.9 Audio Subsystem

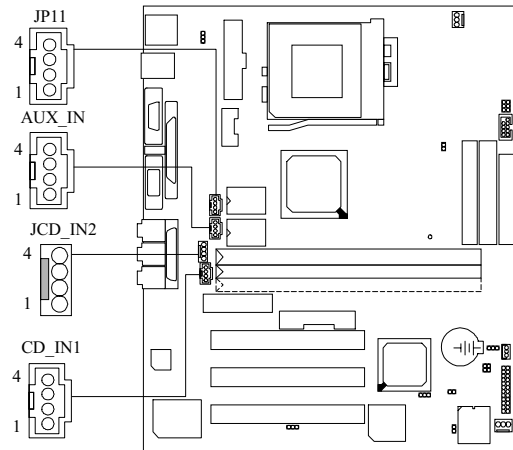

### 1.9.1 CD Audio-In Connectors (CD\_IN1/JCD\_IN2)

Pin No. of JCD_IN2	Assignment
1	Left Channel Input
2	GND
3	GND
4	Right Channel Input

Pin No. of CD_IN1	Assignment
1	Left Channel Input
2	GND
3	Right Channel Input
4	GND

### 1.9.2 Telephony Connector (JP11)

Pin No.	TAD
1	MONO_IN
2	GND
3	GND
4	MONO_OUT

### 1.9.3 AUX Audio in Connector (AUX\_IN)

Pin No.	Signal Name
1	Left channel AUX_IN
2	GND
3	GND
4	Right channel AUX_IN

## 1.10 LCD Daughter Card Subsystem (Optional)

### 1.10.1 Features

#### High Bandwidth

- 25MHz (640x480) to 112MHz (1280x1024).
- Three TMD<sup>TM</sup> data channels capable of transferring up to 1.12Gbps per channel.

#### Flexible Interface

- 12-bit pixel / clock input for true color (16.7 million) support.
- Supports single or dual edge clocking.
- Supports single or multiphase clocking in 12-bit mode.
- Parallel data can be latched on the positive or negative edge for single edge clocking.
- De-skewing option to vary clock to data timing.

#### Receiver Detection

- Supports VESA<sup>®</sup> P&D<sup>TM</sup> and DFP Hot Plug Detection through RxDetect feature.

#### Universal Transmitter

- Operates with all PanelLink<sup>TM</sup> receivers.

#### On Chip Jitter Filter

- On-chip jitter filter enabling tolerance to Graphics Controller output clock jitter.

#### Skew Tolerant

- Inter-pair skew tolerance up to 1 input clock cycle (15nsec at 65MHz).

#### Cable Distance Support and Fiber Optics Ready

- Adjustable TMDS<sup>TM</sup> low-voltage swing signaling for long distance support.
- DC-balanced signals for direct coupling to fiber optics ready modules.

**VESA® Standards Compliant**

- VESA® P&D™.
- VESA® FPDI-2™.

**LOW Power**

- 3.3V core operation.
- Power-down mode.

**LOW Cost Industry Standard Package**

- 64-pin TQFP.

**1.10.2 Installation**  
**Layout of DL01**  
**Model No.DL01**

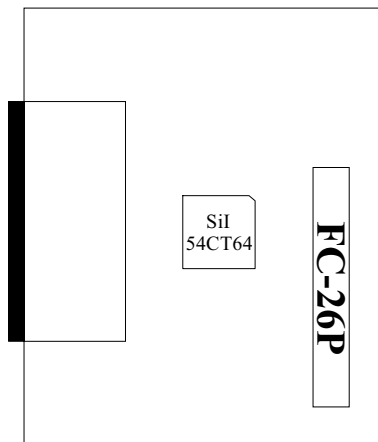

Red Line for PIN 1

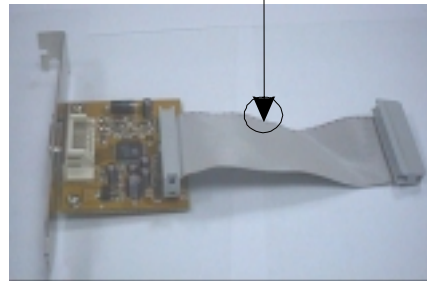

## 1.11 MR Card Subsystem (Optional)

### 1.11.1 Features

**Complete DAA includes:**

- AC'97 2.1 Compliant.
- International Line Interface.
- Compliant with FCC, CTR21, JATE, and Other PTTs.
- 84 dB Dynamic Range TX/RX Paths.
- 3.3 or 5V Power Supply.
- Integrated Ring Detector.
- Caller ID Support.
- Integrated Analog Front End (AFE).
- 2-to 4-Wire Hybrid.
- Low-Power Standby Mode.
- Low-Profile SOIC Packages.
- Patented ISOCap™ Technology.

### 1.11.2 Installation

#### Layout of RB02

Model NO. RB02

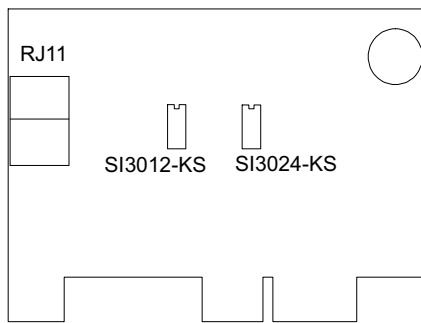



## 2. BIOS Setup

### Introduction

This manual discussed Award™ Setup program built into the ROM BIOS. The Setup program allows users to modify the basic system configuration. This special information is then store in battery-backed RAM so that it retains the Setup information when the power is turned off.

The Award BIOS™ installed in your computer system's ROM (Read Only Memory) is a custom version of an industry standard BIOS. This means that it supports Intel processors in a standard PC/Micro ATX compatible input/output system. The BIOS provides critical low-level support for standard devices such as disk drives and serial and parallel ports.

Adding important has customized the Award BIOS™, but nonstandard, features such as virus and password protection as well as special support for detailed fine-tuning of the chipset controlling the entire system.

The rest of this manual is intended to guide you through the process of configuring your system using Setup.

### Plug and Play Support

These AWARD BIOS supports the Plug and Play specification. ESCD (Extended System Configuration Data) write is supported.

### EPA Green PC Support

This AWARD BIOS supports Version 1.03 of the EPA Green PC specification.

### APM Support

These AWARD BIOS supports Version 1.1&1.2 of the Advanced Power Management (APM) specification. Power management features are implemented via the System Management Interrupt (SMI). Sleep and Suspend power management modes are supported. Power to the hard disk drives and video monitors can be managed by this AWARD BIOS.

### PCI Bus Support

This AWARD BIOS also supports Version 2.1 of the Intel PCI (Peripheral Component Interconnect) local bus specification. Please see the Intel technical documentation for additional information.

### DRAM Support

SDRAM (Synchronous DRAM) are supported.

### Supported CPUs

This AWARD BIOS supports a single Intel Celeron™ CPU. Dual CPUs are not supported.

### Using Setup

In general, you use the arrow keys to highlight items, press <Enter> to select, use the PageUp and PageDown keys to change entries, press <F1> for help and press <Esc> to quit. The following table provides more detail about how to navigate in the Setup program using the keyboard.

Keystroke	Function
Up arrow	Move to previous item
Down arrow	Move to next item
Left arrow	Move to the item on the left (menu bar)
Right arrow	Move to the item on the right (menu bar)
Esc	Main Menu: Quit without saving changes Submenus: Exit Current page to the next higher level menu
Move Enter	Move to the item you desired
PgUp key	Increase the numeric value or make changes
PgDn key	Decrease the numeric value or make changes
+ Key	Increase the numeric value or make changes
- Key	Decrease the numeric value or make changes
Esc key	Main Menu – Quit and not save changes into CMOS Status Page Setup Menu and Option Page Setup Menu – Exit Current page and return to Main Menu
F1 key	General help on Setup navigation kdys
F5 key	Load previous values from CMOS
F6 key	Load the fail-safe defaults from BIOS default table
F7 key	Load the optimized defaults
F10 key	Save all the CMOS changes and exit

## 2.1 Main Menu

Once you enter Award BIOS™ CMOS Setup Utility, the Main Menu will appear on the screen. The Main Menu allows you to select from several setup functions and two exit choices. Use the arrow keys to select among the items and press <Enter> to accept and enter the sub-menu.

### ■ Figure 1. Main Menu

CMOS Setup Utility-Copyright (C ) 1984-1999 Award Software

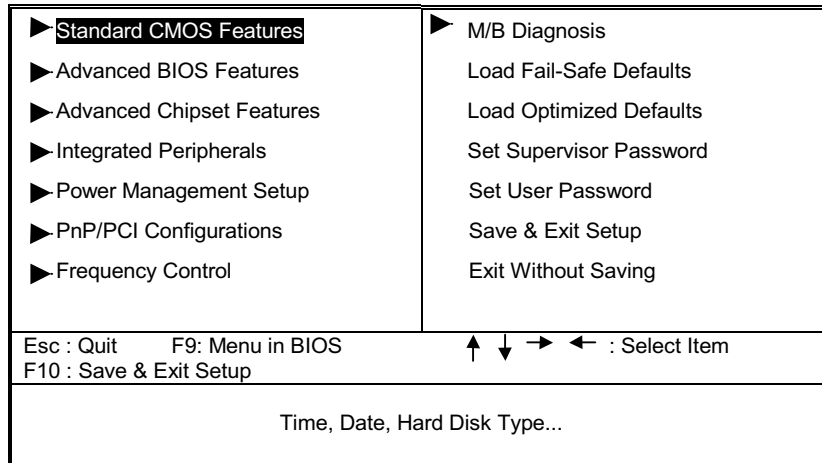

#### Standard CMOS Features

This setup page includes all the items in a standard compatible BIOS.

#### Advanced CMOS Features

This setup page includes all the items of BIOS special enhanced features.

#### Advanced Chipset Features

This setup page includes all the items of chipset special features.

#### Integrated Peripherals

This section page includes all the items of IDE hard drive and Programmed Input/Output features.

**Power Management Setup**

This setup page includes all the items of power management features.

**PnP/PCI Configurations**

This setup page includes IRQ Setting by user define or default.

**Frequency Control**

This setup page includes the CPU Host frequency and CPU Ratio.

**M/B Diagnosis (Optional)**

This setup page induces the several system diag functions.

**Load Fail-Safe Defaults**

Use this menu to load the BIOS default values for the minimal/stable performance for your system to operate.

**Load Optimized Defaults**

These settings are more likely to configure a workable computer when something is wrong. If you cannot boot the computer successfully, select the BIOS Setup options and try to diagnose the problem after the computer boots. These settings do not provide optimal performance.

**Set Supervisor Password**

Change, set, or disable password. It allows you to limit access to the system and Setup, or just to Setup.

**Set User Password**

You can specify both a User and a Supervisor password. When you select either password option, you are prompted for a 1-6-character password. Enter the password and then retype the password when prompted.

**Save & Exit Setup**

Save CMOS value changes to CMOS and exit setup.

**Exit Without Saving**

Abandon all CMOS value changes and exit setup.

## 2.2 Standard CMOS Features

The items in Standard CMOS Setup Menu are divided into 10 categories. Each category includes no, one or more than one setup items. Use the arrow keys to highlight the item and then use the <PgUp> or <PgDn> keys to select the value you want in each item.

### ■ Figure 2. Standard CMOS Setup

CMOS Setup Utility-Copyright (C ) 1984-1999 Award Software  
Standard CMOS Features

Date (mm:dd:yy)	Tue, <b>Apr</b> 27 1999	Item Help
Time (hh:mm:ss)	11 : 37 : 30	Menu Level ▶
▶ IDE Primary Master	Press Enter None	Change the day, month year and century.
▶ IDE Primary Slave	Press Enter None	
▶ IDE Secondary Master	Press Enter None	
▶ IDE Secondary Slave	Press Enter None	
Drive A	1.44M, 3.5 in	
Drive B	None	
Video	EGA/VGA	
Halt On	All, But Keyboard	
Base Memory	XXXX	
Extended Memory	XXXX	
Total Memory	XXXX	

↑ ↓ → ← : Move Enter :Select +/-/PU/PD :Value F10 :Save ESC :Exit F1 :General Help  
F5 :Previous Values F6 :Fail-Safe Defaults F7 : Optimized Defaults

**Main Menu Selections**

This table shows the selections that you can make on the Main Menu.

<b>Item</b>	<b>Options</b>	<b>Description</b>
Date	MoM DD YYYY	Set the system date. Note That the 'Day' automatically changes when you set the date.
IDE Primary Master	Options are in its sub menu.	Press <Enter> to enter the sub menu of detailed options
IDE Primary Slave	Options are in its sub menu.	Press <Enter> to enter the sub menu of detailed options.
IDE Secondary Master	Options are in its sub menu.	Press <Enter> to enter the sub menu of detailed options.
IDE Secondary Slave	Options are in its sub menu.	Press <Enter> to enter the sub menu of detailed options.
Drive A Drive B	None 360K, 5.25 in 1.2M, 5.25 in 720K, 3.5 in 1.44M, 3.5 in 2.88M, 3.5 in	Select the type of floppy disk drive installed in your system.
Video	EGA/VGA CGA 40 CGA 80 MONO	Select the default vieo device.

---

<b>Item</b>	<b>Options</b>	<b>Description</b>
Halt On	All Errors No Errors All, but Keyboard All, but Diskette All, but Disk/Key	Select the situation in which you want the BIOS to stop the POST process and notify you.
Base Memory	N/A	Displays the amount of conventional memory detected during boot up.
Extended Memory	N/A	Displays the amount of extended memory detected during boot up.
Total Memory	N/A	Display the total memory available in the system.

## 2.3 Advanced BIOS Features

### ■ Figure 3. Advanced BIOS Setup

CMOS Setup Utility-Copyright (C ) 1984-1999 Award Software  
Advanced BIOS Features

Virus Warning	<b>Disabled</b>	Item Help
CPU Internal Cache	Enabled	
External Cache	Enabled	Menu Level ▶
CPU L2 Cache ECC Checking	Enabled	
Quick Power On Self Test	Enabled	
First Boot Device	Floppy	
Second Boot Device	HDD-0	
Third Boot Device	SCSI	
Boot Other Device	Enabled	
Swap Floppy Drive	Disabled	
Boot Up Floppy Seek	Enabled	
Boot Up NumLock Status	On	
Gate A20 Option	Fast	
Typematic Rate Setting	Disabled	
Typematic Rate (Chars/Sec)	6	
Typematic Delay (Msec)	250	
Security Option	Setup	
Os Select For DRAM > 64 MB	Non-OS2	
Report No FDD For WIN 95	No	

↑ ↓ → ← : Move Enter :Select +/-/PU/PD :Value F10 :Save ESC :Exit F1 :General Help  
F5 :Previous Values F6 :Fail-Safe Defaults F7 : Optimized Defaults



**Virus Warning**

Allows you to choose the VIRUS Warning feature for IDE Hard Disk boot sector protection. If this function is enabled and someone attempts to write data into this area, BIOS will show a warning message on screen and alarm beep.

<b>Disabled</b> (default)	No warning message appears when anything attempts to access the boot sector or hard disk partition table.
<b>Enabled</b>	Activates automatically when the system boots up causing a warning message to appear when anything attempts to access the boot sector of hard disk partition table.

**CPU Internal /External Cache**

These two categories speed up memory access. However, it depends on CPU/chipset design.

<b>Enabled</b> (default)	Enable cache
<b>Disabled</b>	Disable cache

**CPU L2 Cache ECC Checking**

This item allows you to enable/disable CPU L2 Cache ECC checking.

**The Choices:** Enabled (default), Disabled.

**Quick Power On Self Test**

This category speeds up Power on Self-Test (POST) after you power up the computer. If it is set to Enable, BIOS will shorten or skip some check items during POST.

<b>Enabled</b> (default)	Enable quick POST
<b>Disabled</b>	Normal POST

**First /Second/Third/Other Boot Device**

These BIOS attempts to load the operating system from the devices in the sequence selected in these items.

**The Choices:** Floppy, LS/ZIP, HDD SCSI, CDROM, Enabled.

**Swap Floppy Drive**

If the system has two floppy drives, you can swap the logical drive name assignments.

**The Choices:** Enabled, Disabled (default).

**Boot Up Floppy Seek**

Seeks disk drives during boot up. Disabling speeds boot up.

**The Choices:** Enabled (default), Disabled.

**Boot Up NumLock Status**

Select power on state for NumLock.

**On** (default)                      Numpad is number keys.  
**Off**                                      Numpad is arrow keys.

**Gate A20 Option**

Select if chipset or keyboard controller should control GateA20.

**Normal**                                A pin in the keyboard controller controls GateA20.  
**Fast** (default)                      Lets chipset control GateA20.

**Typematic Rate Setting**

Keystroke repeat at a rate determined by the keyboard controller. When enabled, the typematic rate and typematic delay can be selected.

**The Choices:** Enabled, Disabled (default).

**Typematic Rate (Chars/Sec)**

Sets the number of times a second to repeat a keystroke when you hold the key down.

**The Choices:** 6 (default), 8, 10, 12, 15, 20, 24, 30.

**Typematic Delay (Msec)**

Sets the delay time after the key is held down before it begins to repeat the keystroke.

**The Choices:** 250 (default), 500, 750, 1000.

**Security Option**

Select whether the password is required every time the system boots or only when you enter setup.

**System**                                The system will not boot and access to Setup will be denied if the correct password is not entered at the prompt.  
**Setup** (default)                      The system will boot, but access to Setup

will be denied if the correct password is not entered at the prompt.

***Note:** To disable security, select **PASSWORD SETTING** at Main Menu and then you will be asked to enter password. Do not type anything and just press <Enter>, it will disable security. Once the security is disabled, the system will boot and you can enter Setup freely.*

**OS Selection for DRAM > 64MB**

Select the operating system that is running with greater than 64MB of RAM on the system.

**The Choices:** Non-OS2 (default), OS2.

**Report No FDD For WIN 95**

Whether report no FDD for Win 95 or not.

**The Choices:** Yes, No (default).

## 2.4 Advanced Chipset Features

This section allows you to configure the system based on the specific features of the installed chipset. This chipset manages bus speeds and access to system memory resources, such as DRAM and the external cache. It also coordinates communications between the conventional ISA bus and the PCI bus. It must be stated that these items should never need to be altered. The default settings have been chosen because they provide the best operating conditions for your system. The only time you might consider making any changes would be if you discovered that data was being lost while using your system.

### ■ Figure 4. Advanced Chipset Setup

CMOS Setup Utility-Copyright (C ) 1984-1999 Award Software  
Advanced Chipset Features

SDRAM CAS Latency Time	3	Item Help
SDRAM Cycle Time Tras/Trc	6/8	
SDRAM RAS-to-CAS Delay	3	Menu Level ▶
SDRAM RAS Precharge Time	3	
System BIOS Cacheable	Enabled	
Video BIOS Cacheable	Enabled	
Memory Hole At 15M-16M	Disabled	
Delayed Transaction	Enabled	
On-Chip Video Window Size	64MB	
* Onboard Display Cache Setting *		
CAS# Latency	3	
Paging Mode Control	Close	
RAS-to -CAS Override	by CAS# LT	
RAS# Timing	Slow	
RAS# Precharge Timing	Slow	

↑ ↓ → ← : Move Enter :Select +/-/PU/PD :Value F10 :Save ESC :Exit F1 :General Help  
F5 :Previous Values F6 :Fail-Safe Defaults F7 : Optimized Defaults

**SDRAM CAS Latency Time**

When synchronous DRAM is installed, the number of clock cycles of CAS latency depends on the DRAM timing.

**The Choices:** 2, 3 (default)

**SDRAM Cycle Time Tras/Trc**

Select the number of SCLKs for an access cycle.

**The Choices:** 5/7, 6/8 (default).

**SDRAM RAS-to-CAS Delay**

This field lets you insert a timing delay between the CAS and RAS strobe signals, used when DRAM is written to, read from, or refreshed. Fast gives faster performance; and *Slow* gives more stable performance. This field applies only when synchronous DRAM is installed in the system.

**The Choices:** 2, 3 (default)

**SDRAM RAS Precharge Time**

If an insufficient number of cycles is allowed for RAS to accumulate its charge before DRAM refresh, the refresh may be incomplete and the DRAM may fail to retain data. Fast gives faster performance; and Slow gives more stable performance. This field applies only when synchronous DRAM is installed in the system.

**The Choices:** 2, 3 (default)

**System BIOS Cacheable**

Selecting Enabled allows caching of the system BIOS ROM at F0000h-FFFFh, resulting in better system performance. However, if any program writes to this memory area, a system error may result.

**The Choices:** Enabled (default), Disabled.

**Video BIOS Cacheable**

Select Enabled allows caching of the video BIOS, resulting in better system performance. However, if any program writes to this memory area, a system error may result.

**The Choices:** Enabled (default), Disabled.

**Memory Hole At 15M-16M**

You can reserve this area of system memory for ISA adapter ROM. When this area is reserved, it cannot be cached. The user information of peripherals that need to use this area of system memory usually discusses their memory requirements.

**The Choices:** Enabled, Disabled (default)

**Delayed Transaction**

The chipset has an embedded 32-bit posted write buffer to support delay transactions cycles. Select *Enabled* to support compliance with PCI specification version 2.1.

**The Choices:** Enabled (default), Disabled

**On-Chip Video Window Size**

Select the on-chip video window size for VGA drive use.

**The Choices:** 32MB, 64MB(default), Disabled.

**CAS# Latency (Optional)**

Select the local memory clock periods.

**The Choices:** 2, 3 (default)

**Paging Mode Control (Optional)**

Select the paging mode control.

**Open**

In this mode the GMCH memory controller tends to leave pages open.

**Close (default)**

In this mode the GMCH memory controller tends to leave pages closed.

**RAS-to-CAS Override (Optional)**

Select the display cache clock periods control.

**By CAS# LT (default)**

**RAS# Timing (Optional)**

This item controls RAS# active to Protegra, and refresh to RAS# active delay ( in local memory clock).

**Slow** (default)

**RAS# Precharge Timing (Optional)**

This item controls RAS# precharge (in local memory clocks).

**Slow** (default)

## 2.5 Integrated Peripherals

### ■ Figure 5. Integrated Peripherals

CMOS Setup Utility-Copyright (C ) 1984-1999 Award Software  
Integrated Peripherals

On-Chip Primary PCI IDE	<b>Enabled</b>	▲ ▼	Item Help
On-Chip Secondary PCI IDE	Enabled		Menu Level ▶
IDE Primary Master PIO	Auto		
IDE Primary Slave PIO	Auto		
IDE Secondary Master PIO	Auto		
IDE Secondary Slave PIO	Auto		
IDE Primary Master UDMA	Auto		
IDE Primary Slave UDMA	Auto		
IDE Secondary Master UDMA	Auto		
IDE Secondary Slave UDMA	Auto		
USB Controller	Enabled		
USB Keyboard Support	Disabled		
Init Display First	PCI Slot		
AC97 Audio	Enabled		
AC97 Modem	Enabled		
IDE HDD Block Mode	Enabled		
Onboard FDC Controller	Enabled		
Onboard Serial Port 1	3F8/IRQ4		
Onboard Serial Port 2	2F8/IRQ3		
UART Mode Select	Normal		
X UR2 Duplex Mode	Half		
X TxD, RxD Polarity Active	Lo, Lo		
X Use IR Pins	IR-Rx2Tx2		
Onboard Parallel Port	378/IRQ7		
Parallel Port Mode	EPP1.9+SPP		
X ECP Mode Use DMA	3		
Game Port Address	201		
Midi Port Address	Disabled		
X Midi Port IRQ	7		

▲ : Move    Enter :Select    +/-/PU/PD :Value    F10 :Save    ESC :Exit    F1 :General Help  
 ▼ : Move    F5 :Previous Values    F6 :Fail-Safe Defaults    F7 : Optimized Defaults



**On-Chip Primary /Secondary PCLIDE**

The integrated peripheral controller contains an IDE interface with support for two IDE channels. Select Enabled to activate each channel separately.

**The Choices:** Enabled (default), Disabled

**IDE Primary / Secondary Master / Slave PIO**

The IDE PIO (Programmed Input / Output) fields let you set a PIO mode (0-4) for each of the IDE devices that the onboard IDE interface supports. Modes 0 through 4 provide successively increased performance. In Auto mode, the system automatically determines the best mode for each device.

**The Choices:** Auto (default), Mode0, Mode1, Mode2, Mode3, Mode4.

**IDE Primary / Secondary Master / Slave UDMA**

Ultra DMA /33 implementation is possible only if your IDE hard drive supports it and the operating environment includes a DMA drive (Windows 95 OSR2 or a third party IDE bus master driver). If your hard drive and your system software both support Ultra DMA/33, select Auto to enable BIOS support.

**The Choices:** Auto (default), Disabled.

**USB Controller**

Select *Enabled* if your system contains a Universal Serial Bus (USB) controller and you have USB peripherals.

**The Choices:** Enabled (default), Disabled.

**USB Keyboard Support**

The default value is Disabled.

<b>Enabled</b>	Enable USB Keyboard Support.
<b>Disable</b> (default)	Disable USB Keyboard Support.

**Init Display First**

This item allows you decide to active whether PCI Slot or on-chip VGA first.

**The Choices:** PCI Slot (default), AGP.

**AC97 Audio/Modem**

This item allows you to decide to enable/disable the 810-chipset family to support AC97 Audio/Modem.

**The Choices:** Enabled (default), Disabled.

#### **IDE HDD Block Mode**

Block mode is also called block transfer, multiple commands, or multiple sector read/write. If your IDE hard drive supports block mode (most new drives do), select Enabled for automatic detection of the optimal number of block mode (most new drives do), select Enabled for automatic detection of the optimal number of block read/writes per sector the drive can support.

**The Choices:** Enabled (default), Disabled.

#### **Onboard FDC Controller**

Select Enabled if your system has a floppy disk controller (FDC) installed on the system board and you wish to use it. If install and FDC or the system has no floppy drive, select Disabled in this field.

**The Choices:** Enabled (default), Disabled.

#### **Onboard Serial Port 1/Port 2**

Select an address and corresponding interrupt for the first and second serial ports.

**The Choices:** Disabled, Auto, (3F8/IRQ4), (2F8/IRQ3), (3E8/IRQ4), (2E8/IRQ3)

#### **UART Mode Select**

This item allows you to determine which Infra Red (IR) function of onboard I/O chip.

**The Choices:** Normal (default), AS KIR, IrDA.

#### **UR2 Duplex Mode**

Select the value required by the IR device connected to the IR port. Full-duplex mode permits simultaneous two-direction transmission. Half-duplex mode permits transmission in one direction only at a time.

**The Choices:** Half (default), Full.

#### **TxD, RxD Polarity Active**

This item allows you to determine the active of RxD, TxD

**The Choices:** “Hi, Hi”, “Lo, Lo” (default), “Lo, Hi”, “Hi, Lo”.

**Use IR Pins**

Consult your IR peripheral documentation to select the correct setting of the TxD and RxD signals.

**The Choices:** IR-Rx2Tx2 (default), RxD2 TxD2.

**Onboard Parallel Port**

This item allows you to determine access onboard parallel port controller with which I/O Address.

**The Choices:** 378/IRQ7 (default), 278/IRQ5, 3BC/IRQ7, Disabled.

**Parallel Port Mode**

The default value is EPP1.9+SPP.

<b>SPP</b>	Using Parallel port as Standard Printer Port.
<b>EPP1.9+SPP (default)</b>	Using Parallel Port as Enhanced Parallel Port.
<b>ECP</b>	Using Parallel port as Extended Capabilities Port.
<b>EPP1.9 +ECP</b>	Using Parallel port as ECP & EPP mode.
<b>PRINTER</b>	Printer Mode.
<b>EPP1.7+SPP</b>	Using Parallel Port as Enhanced Parallel Port.
<b>EPP1.7+ECP</b>	Using Parallel port as ECP & EPP mode.

**ECP Mode Use DMA**

Select a DMA Channel for the port.

**The Choices:** 3 (default), 1.

**Game Port Address**

Game Port I/O Address.

**Disable**  
**201 (default)**  
**209**

**Midi Port Address**

Midi Port Base I/O Address.

**Disabled** (default)

**330**

**300**

**Midi Port IRQ**

This determines the IRQ in which the Midi Port can use.

**The Choices:** 7 (default), 5.

## 2.6 Power Management Setup

The Power Management Setup allows you to configure your system to most effectively save energy while operating in a manner consistent with your own style of computer use.

### ■ Figure 6. Power Management Setup

CMOS Setup Utility-Copyright (C ) 1984-1999 Award Software  
Power Management Setup

ACPI Function	Enabled	▲ ↑ ↓ ▼	Item Help
ACPI Suspend Type	S1 (POS)		Menu Level ▶
Power Management	User Define		
Video Off Method	DPMS		
Video Off In Suspend	Yes		
Suspend Type	Stop Grant		
MODEM Use IRQ	3		
Suspend Mode	Disabled		
HDD Power Down	Disabled		
Soft-Off by PWR-BTTN	Instant-Off		
Wake-Up by PCI card	Disabled		
Power On by Ring	Disabled		
Wake Up On LAN	Disabled		
CPU Thermal-Throttling	50.0 %		
Resume by Alarm	Disabled		
X Date (of Month) Alarm	0		
X Time (hh:mm:ss) Alarm	0 0 0		
** Reload Global Timer Events **			
Primary IDE 0	Enabled		
Primary IDE 1	Enabled		
Secondary IDE 0	Disabled		
Secondary IDE 1	Disabled		
FDD, COM, LPT Port	Enabled		
PCI PIRQ [A-D] #	Enabled		

↑ ↓ → ← : Move Enter :Select +/-/PU/PD :Value F10 :Save ESC :Exit F1 :General Help  
F5 :Previous Values F6 :Fail-Safe Defaults F7 : Optimized Defaults

**ACPI Function**

This item allows you to enable/disable the Advanced Configuration and Power Management (ACPI).

**The Choices:** Enabled (default), Disabled.

**ACPI Suspend Type**

The item allows you to select the suspend type under ACPI operating system.

<b>S1 (POS)</b> (default)	Power on Suspend
<b>S3 (STR)</b>	Suspend to RAM

**Power Management**

This category allows you to select the type (or degree) of power saving and is directly related to the following modes:

1. HDD Power Down.
2. Doze Mode.
3. Suspend Mode.

There are four selections for Power Management, three of which have fixed mode settings

<b>Disabled</b>	No power management. Disables all four modes.
<b>Min. Power Saving</b>	Minimum power management. Doze Mode = 1 hr. Standby Mode = 1 hr., Suspend Mode = 1 hr., and HDD Power Down = 15 min.
<b>Max. Power Saving</b>	Maximum power management—ONLY AVAILABLE FOR SL CPU's. Doze Mode = 1 min., Standby Mode = 1 min., Suspend Mode = 1 min., and HDD Power Down = 1 min.
<b>User Define</b> (default)	Allows you to set each mode individually. When not disabled, each of the ranges are from 1 min. to 1 hr. except for HDD Power Down which ranges from 1 min. to 15 min. and disable.

**Video Off Method**

This determines the manner in which the monitor is blanked.

<b>V/H SYNC+Blank</b>	This selection will cause the system to turn off the vertical and horizontal synchronization ports and write blanks to the video buffer.
<b>Blank Screen</b>	This option only writes blanks to the video buffer.
<b>DPMS (default)</b>	Initial display power management signaling.

**Video Off In Suspend**

This determines the manner in which the monitor is blanked.

**The Choices:** Yes (default), No.

**Suspend Type**

Select the Suspend Type.

**The Choices:** PWRON Suspend, Stop Grant (default).

**MODEM Use IRQ**

This determines the IRQ in which the MODEM can use.

**The Choices:** 1, 3 (default), 4, 5, 7, 9, 10, 11, NA.

**Suspend Mode**

When enabled and after the set time of system inactivity, all devices except the CPU will be shut off.

**Disabled** (default)

**Enabled**

**HDD Power Down**

When enabled and after the set time of system inactivity, the hard disk drive will be powered down while all other devices remain active.

**Disabled** (default)

**Enabled**

**Soft-Off by PWR-BTTN**

Pressing the power button for more than 4 seconds forces the system to enter the Soft-Off state when the system has "hung."

**The Choices:** Delay 4 Sec, Instant-Off (default)

**Wake-Up by PCI card**

When you select Enabled, a PME signal from PCI card returns the system to Full On state.

**The Choice:** Enabled, Disabled (default).

**Power On by Ring**

An input signal on the serial Ring Indicator (RI) line (in other words, an incoming call on the modem) awakens the system from a soft off state.

**Disabled** (default)

**Wake Up On LAN**

To use this function, you need a LAN add-on card which support power on functions. It should also support the wake-up on LAN jumper.

**Disabled** (default)      Wake up on LAN not supported.

**CPU Thermal-Throttling**

Select the CPU THRM-Throttling rate.

**The Choices:** 25.0%, 37.5%, 50.0% (default), 62.5%, 75.0%, 87.5%.

**Resume by Alarm**

This function is for setting date and time for your computer to boot up. During Disabled, you cannot use this function. During Enabled, Choose the Date and Time Alarm:

**Date (of month) Alarm**      You can choose which month the system will boot up.

**Time (hh:mm:ss) Alarm**      You can choose what hour, minute and second the system will boot up.

**Note:** *If you have change the setting, you must let the system boot up until it goes to the operating system, before this function will work.*



**PM Events**

PM events are I/O events whose occurrence can prevent the system from entering a power saving mode or can awaken the system from such a mode. In effect, the system remains alert for anything, which occurs to a device, which is configured as *Enabled*, even when the system is in a power down mode.

**Primary IDE 0/1**

**Secondary IDE 0/1**

**FDD, COM, LPT Port**

**PCI PIRQ [A-D]#**

## 2.7 PnP/PCI Configurations

This section describes configuring the PCI bus system. PCI, or Personal Computer Interconnect, is a system which allows I/O devices to operate at speeds nearing the speed the CPU itself uses when communicating with its own special components. This section covers some very technical items and it is strongly recommended that only experienced users should make any changes to the default settings.

### ■ Figure 7. PnP/PCI Configurations

CMOS Setup Utility-Copyright (C ) 1984-1999 Award Software  
Pnp/PCI Configurations

Reset Configuration Data	<b>Disabled</b>	Item Help
Resources Controlled By	Auto (ESCD)	Menu Level ▶
X IRQ Resources	Press Enter	Default is Disabled. Select Enabled to reset Extended System Configuration Data (ESCD) when you exit Setup if you have installed a new add-on and the system reconfiguration has caused such a serious conflict that the OS cannot boot.
X Memory Resources	Press Enter	
PCI/VGA Palette Snoop	Disabled	

↑ ↓ → ← : Move Enter :Select +/-/PU/PD :Value F10 :Save ESC :Exit F1 :General Help  
F5 :Previous Values F6 :Fail-Safe Defaults F7 : Optimized Defaults

### **Reset Configuration Data**

The system BIOS supports the PnP feature so the system needs to record which resource is assigned and proceeds resources from conflict. Every peripheral device has a node, which is called ESCD. This node records which resources are assigned to it. The system needs to record and update ESCD to the memory locations. These locations (4K) are reserved at the system BIOS.

If Disabled (default) is chosen, the system's ESCD will update only when the new configuration varies from the last one.

If Enabled is chosen, the system is forced to update ESCDs and then is automatically set to the "Disabled" mode.

IRQ-3	assigned to : PCI / ISA PnP
IRQ-4	assigned to : PCI / ISA PnP
IRQ-5	assigned to : PCI / ISA PnP
IRQ-7	assigned to : PCI / ISA PnP
IRQ-9	assigned to : PCI / ISA PnP
IRQ-10	assigned to : PCI / ISA PnP
IRQ-11	assigned to : PCI / ISA PnP
IRQ-12	assigned to : PCI / ISA PnP
IRQ-14	assigned to : PCI / ISA PnP
IRQ-15	assigned to : PCI / ISA PnP
DMA-0	assigned to : PCI / ISA PnP
DMA-1	assigned to : PCI / ISA PnP
DMA-3	assigned to : PCI / ISA PnP
DMA-5	assigned to : PCI / ISA PnP
DMA-6	assigned to : PCI / ISA PnP
DMA-7	assigned to : PCI / ISA PnP

The above settings will be shown on the screen only if "Manual" is chosen for the Resources Controlled By function.

Legacy is the term, which signifies that a resource is assigned to the ISA Bus and provides for non-PnP ISA add-on cards. PCI / ISA PnP signifies that a resource is assigned to the PCI Bus or provides for ISA PnP add-on cards and peripherals.

### **Resources Controlled By**

By Choosing "Auto" the system BIOS will detect the system resources and automatically assign the relative IRQ and DMA channel for each peripheral.

By Choosing "Manual", the user will need to assign IRQ & DMA for add-on

cards. Be sure that there are no IRQ/DMA and I/O port conflicts.

### **IRQ Resources**

When resources are controlled manually, assign each system interrupt a type, depending on the type of device using the interrupt.

### **Memory Resources**

This sub menu can let you control the memory resource.

### **PCI / VGA Palette Snoop**

Choose Disabled or Enabled. Some graphic controllers which are not VGA compatible take the output from a VGA controller and map it to their display as a way to provide boot information and VGA compatibility.

However, the color information coming from the VGA controller is drawn from the palette table inside the VGA controller to generate the proper colors, and the graphic controller needs to know what is in the palette of the VGA controller. To do this, the non-VGA graphic controller watches for the Write access to the VGA palette and registers the snoop data. In PCI based systems, where the VGA controller is on the PCI bus and a non-VGA graphic controller is on an ISA bus, the Write Access to the palette will not show up on the ISA bus if the PCI VGA controller responds to the Write.

In this case, the PCI VGA controller should not respond to the Write, it should only snoop the data and permit the access to be forwarded to the ISA bus. The non-VGA ISA graphic controller can then snoop the data on the ISA bus. Unless you have the above situation, you should disable this option.

<b>Disabled</b> (default)	Disables the function.
<b>Enabled</b>	Enables the function.

## 2.8 Frequency Control

### ■ Figure 8. Frequency Control

CMOS Setup Utility-Copyright (C ) 1984-1999 Award Software  
Frequency/ Voltage Control

CPU Host/ PCI Clock	<b>Default</b>	Item Help
CPU Ratio	X 3	Menu Level ▶

↑ ↓ → ← : Move    Enter :Select    +/-/PU/PD :Value    F10 :Save    ESC :Exit    F1 :General Help  
 F5 :Previous Values    F6 :Fail-Safe Defaults    F7 : Optimized Defaults

#### CPU Host/PCI Clock

The item allows you select CPU Host/PCI clock.

#### CPU Ratio

This item allows you to select the CPU ratio.

## 2.9 M/B Diagnosis (Optional)

### ■ Figure 9. M/B Diagnosis

CMOS Setup Utility-Copyright (C ) 1984-1999 Award Software  
M/B Diagnosis

CPU Function Test	<b>Press Enter</b>	Item Help
Memory Test	Press Enter	
FDC Test	Press Enter	Menu Level ▶
PnP/PCI Device	Press Enter	

↑ ↓ → ← : Move Enter :Select +/-/PU/PD :Value F10 :Save ESC :Exit F1 :General Help  
F5 :Previous Values F6 :Fail-Safe Defaults F7 : Optimized Defaults

#### **CPU Function Test**

This item allows you to test CPU basic function

#### **Memory Test**

This item allows you to test RAM.

#### **FDC Test**

The item allows you to test floppy controller.

#### **PnP/PCI Device**

The item allows you to check the PnP/PCI device.

## 2.10 Load Fail-Safe Defaults

When you press <Enter> on this item you get a confirmation dialog box with a message similar to:

### ■ Figure 10. Load Fail-Safe Defaults

CMOS Setup Utility-Copyright (C ) 1984-1999 Award Software

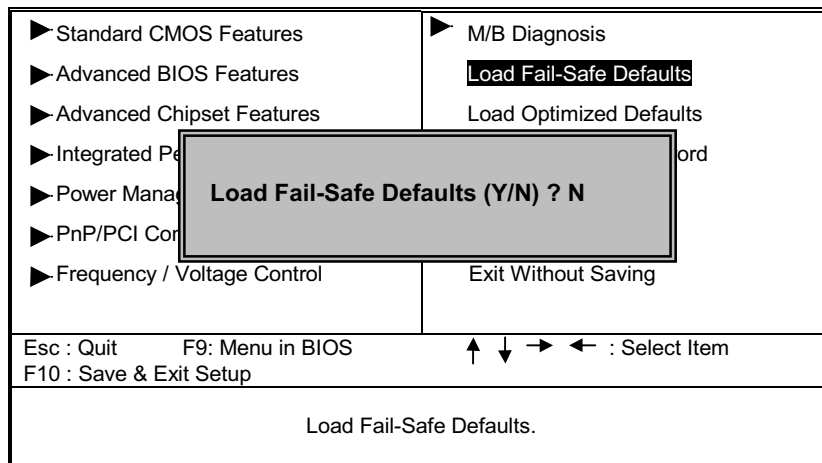

Pressing 'Y' loads the BIOS default values for the most stable, minimal-performance system operations.

## 2.11 Load Optimized Defaults

When you press <Enter> on this item you get a confirmation dialog box with a message similar to:

### ■ Figure 11. Load Optimized Defaults

CMOS Setup Utility-Copyright (C ) 1984-1999 Award Software

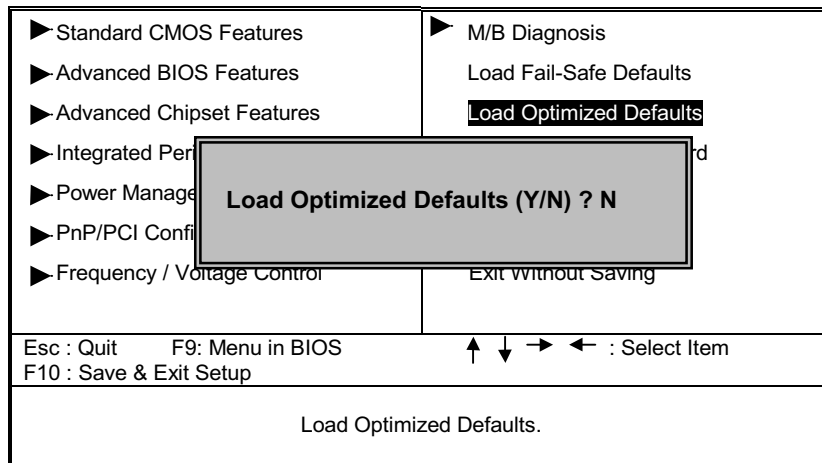

Pressing 'Y' loads the default values that are factory settings for optimal performance system operations.



## 2.12 Set Supervisor/User Password

### ■ Figure 12. Set Supervisor/User Password

CMOS Setup Utility-Copyright (C ) 1984-1999 Award Software

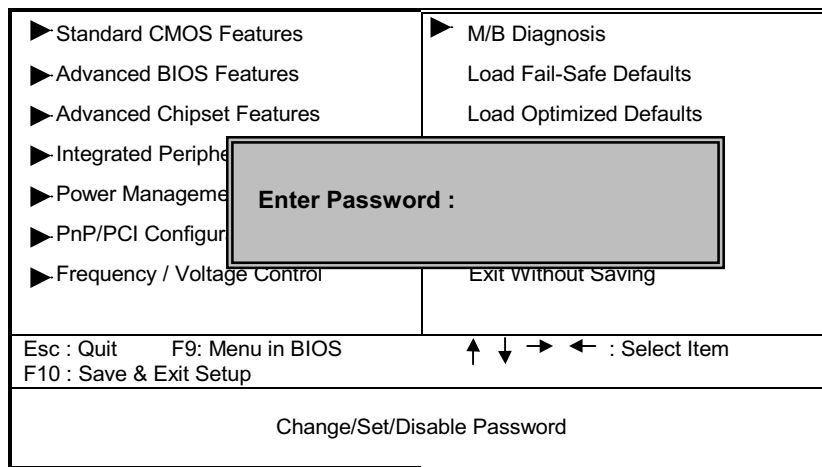

When you select this function, the following message will appear at the center of the screen to assist you in creating a password.

### ENTER PASSWORD

Type the password, up to eight characters, and press <Enter>. The password you type now will clear any previously entered password from CMOS memory. You will be asked to confirm the password. Type the password again and press <Enter>. You may also press <ESC> to abort the selection and not enter a password. To disable password, just press <Enter> when you are prompted to enter password. A message will confirm that you wish to disable the password. Once the password is disabled, the system will boot and you can enter setup freely.

**PASSWORD DISABLED**

If you select "System" at the Security Option of BIOS Features Setup Menu, you will be prompted for the password every time the system is rebooted or any time you try to enter Setup. If you select "Setup" at Security Option of BIOS Feature Setup Menu, you will be prompted only when you try to enter Setup.

## 2.13 Save & Exit Setup

### ■ Figure 13. Save & Exit Setup

CMOS Setup Utility-Copyright (C ) 1984-1999 Award Software

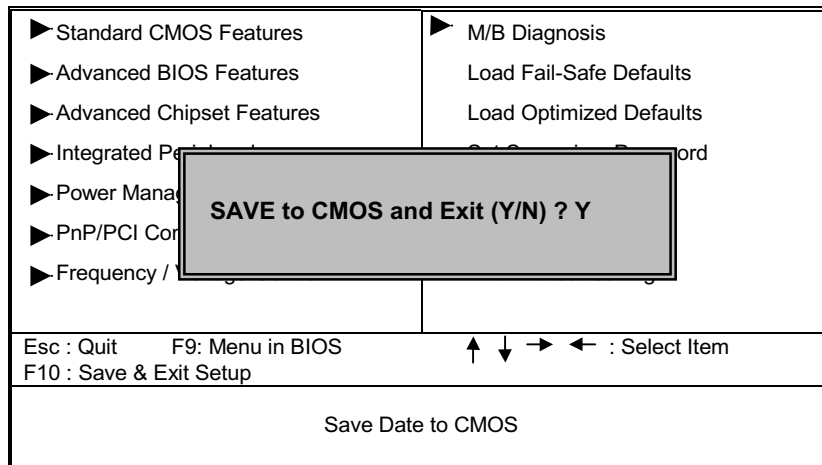

Type "Y" will quit the Setup Utility and save the user setup value to RTC CMOS RAM.

Type "N" will return to Setup Utility.

## 2.14 Exit Without Saving

### ■ Figure 14. Exit Without Saving

CMOS Setup Utility-Copyright (C ) 1984-1999 Award Software

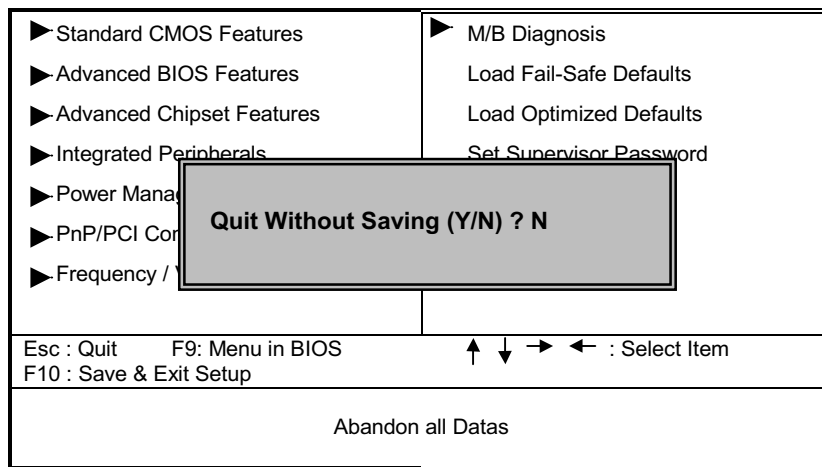

Type "Y" will quit the Setup Utility without saving to RTC CMOS RAM.  
Type "N" will return to Setup Utility.

## 3 Software

### 3.1 Software

#### 3.1.1 Software List

Category	Description	Platform
Windows 9x Inf Patch Utility Driver	The INF Update Utility for Intel Chipsets installs to the target system the Windows* 95 or Windows* 98 INF files that outline to the operating system how the chipset components shall be configured.	Windows 95/98
HighPoint XStore Pro	Drivers that support Ultra DMA mode Hard Drive.	Windows 95/98
Award Flash Utility	Used for updating BIOS. (Please refer to chapter - Application Software.)	Need to be run under <b>DOS</b> environment.
Intel 810 Chipset Graphics	Drivers and Control Panel Utility for Intel 810 Chipset Graphics.	Windows 95/98/NT4.0/2000
SoundMax Integrated Digital Audio (Optional)	Drivers for AC97 Audio.	Windows 95/98/NT4.0/2000
Aureal Vortex AU8810 PCI Audio(Optional)	Drivers for AC97 Audio	Windows 95/98
HAMR56xx Soft Modem <b>(Note: Need an AMR Modem Card)</b>	Drivers for AC97 Modem	Windows 95/98
Microsoft DirectX	Microsoft DirectX runtime library	Windows 95/98

### 3.1.2 Software Installation

We provide a Wizard with User Interface, Driver CD Installation Utility (START.EXE), located in the root of Driver CD to let you install drivers conveniently.

The Wizard can automatically detect OS and switch to the proper page, so you don't need to worry about installing the wrong drivers.

You can simply put Driver CD into CD-ROM drive and the Installation Utility will autorun or you can launch the Driver CD Installation Utility manually.



**There are two kinds of Installation Procedure:****➤ Automatically Install drivers from CD by using CD Installation Utility:**

Use mouse cursor to click the proper option on the page. Utility will invoke other applications to complete the rest of installation.

**➤ When the drivers CAN NOT be installed directly from CD by using CD Installation Utility, please do the following procedure :**

Please read the README.TXT located in the root directory on Multimedia CD to get drivers' location and then refer to the INSTALL.TXT or README.TXT files located in each driver directory on the Driver CD to install drivers.

### 3.1.3 Software Usage

- **Note:** In general, you can get more detailed information in the on-line help or readme for the software.
  
- **Using Intel 810 Chipset Graphics Control Panel Utility:**
  - Note: Move the mouse cursor to the background of screen and right-click the mouse and then **Display Properties dialog** will pop-up.
  
  - ✧ Select **Color** properties sheet in the Display Properties dialog, you can do Gamma Correction of Red, Green and Blue Color Channels in this page.

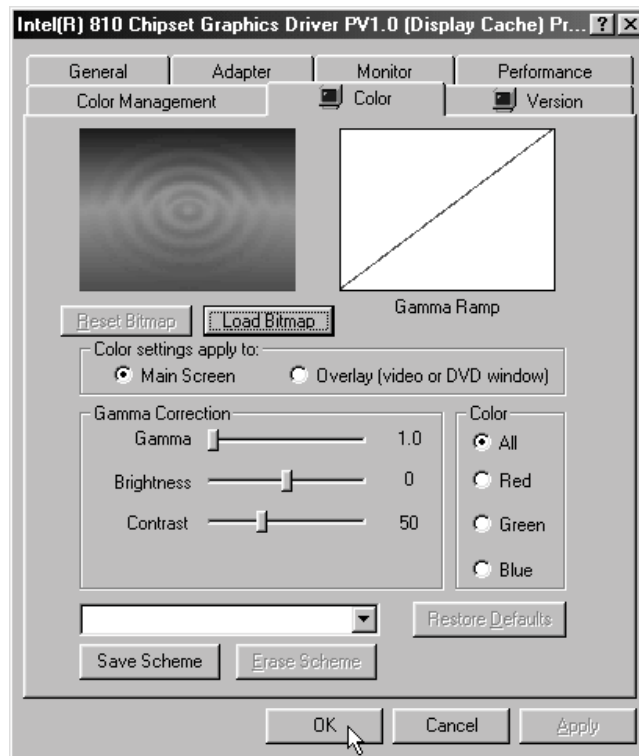



- ✧ Select **Version** property sheet in the Display Properties dialog, you can get the display driver information, VGA BIOS information, Memory Size and DirectX version.

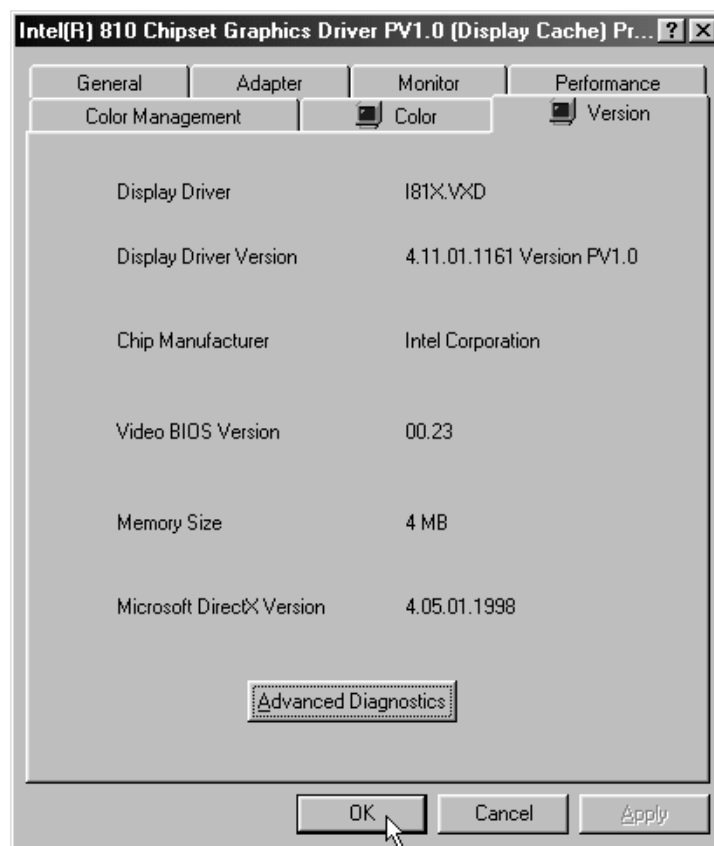

- ✧ In the above page, click the **Advanced Diagnostics** button and then **Intel® Graphics Diagnostic Utility** will be launched.

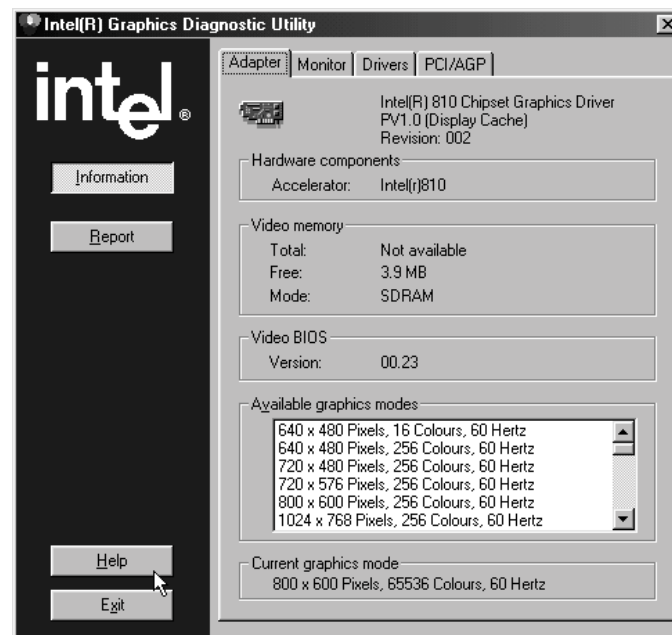

The Intel® Graphics Diagnostic Utility was developed to give you a single source for collecting information about the graphics setup of your computer.

The interface allows you easily to create a report of the graphics setup of your computer, which you can use in troubleshooting technical issues with the system or send to customer support.

For assistance in using the diagnostic utility, click the Help button at the bottom of the blue left-hand column.

➤ **Using Aureal Vortex AU8810 PCI Windows 95/98 Audio Control Panel: (Optional): Visible only when the Aureal Vortex AU8810 PCI Audio chipset included in your hardware.)**

❖ Launch the Control Panel:

1. Double-click the **Aureal Vortex** icon on the Windows taskbar.



2. Or, you can double-click the **Aureal Vortex Audio** icon in the Control Panel window.

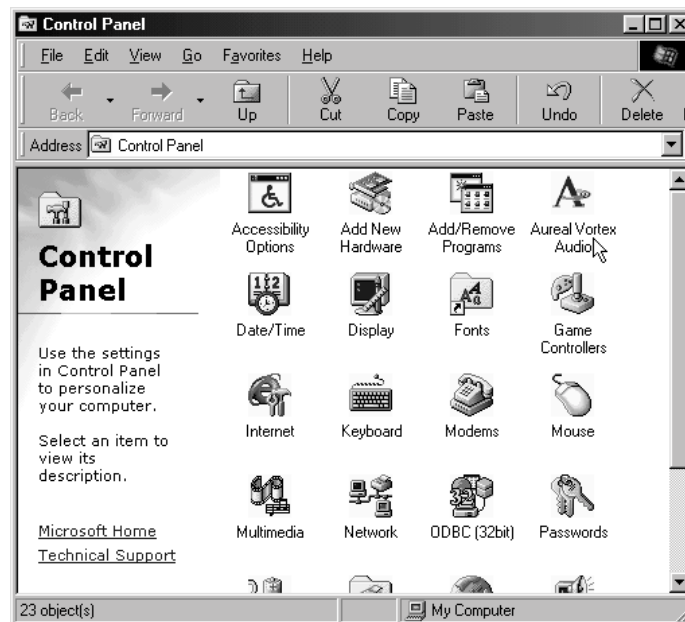

## ❖ Aural Vortex Control Panel Tab:

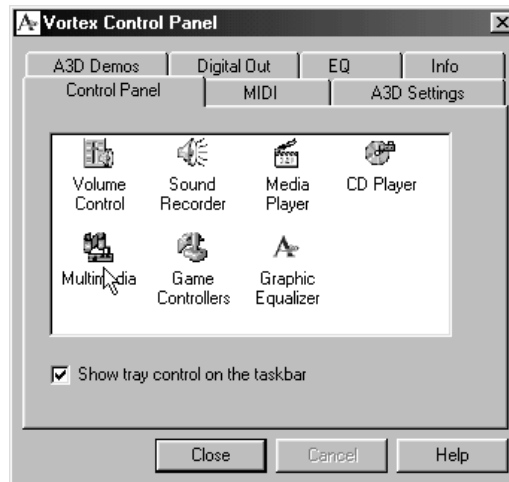
**Other Control Panels**

This window lets you access other sound-related control panels and system applets, such as Volume Control and Sound Recorder.

The Graphic Equalizer applet provides control for a multi band graphic equalizer.

**Show Tray Control in the Taskbar**

When Tray Control is shown, clicking on the Aural logo in the taskbar can open the Vortex Control Panel. The taskbar icon can be removed using this checkbox.

**Taskbar Menu**

Right-click on the Aural logo in the Windows taskbar to see the tray control menu.

**Headphones/Speakers** - Select between headphone and speaker output using the two top options. This setting only affects output from applications using Aural's A3D Interactive positional audio technology.

Adjust Audio Properties - Selecting this menu option has the same affect as double-clicking the taskbar icon, launching the Vortex Control Panel applet.

**Remove tray control** - This removes the icon from the taskbar.

## ❖ Aural Vortex MIDI Tab:

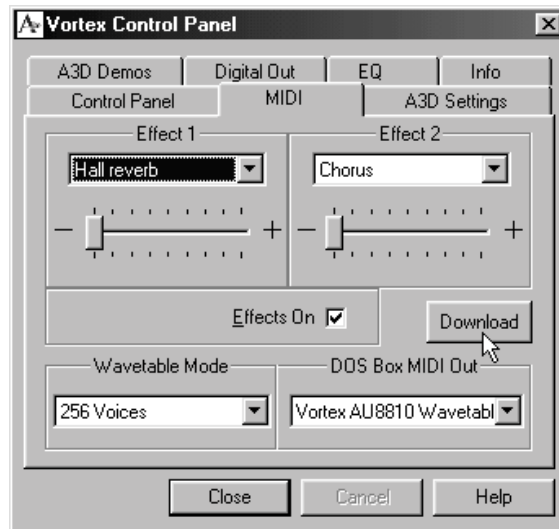
**Destination for DOS Box MIDI Out**

In Windows, this list box selects how MIDI is handled by programs running in DOS boxes. In Windows NT, this list box is not available.

***Vortex AU8810 MPU-401*** - This sends MIDI to an external synthesizer attached to the MIDI port.

***Vortex AU8810 Wavetable*** - This sends MIDI to the Vortex music synthesizer. If you do not have an external synthesizer connected, select "Vortex AU8810 Wavetable."

**Physical Modeling**

This feature is not enabled in this version of the software.

**Wavetable Mode**

Use this list box to select the total number of wavetable voices made available for internal wavetable processing. More voices require more CPU power. This option has no effect on a MIDI stream that is sent out the MPU-401 port.

**Wavetable Effects**

When some MIDI songs start, they request particular amounts of effects in the sound, such as chorus and reverb. There are nine possible effects to choose from: Delay, Room reverb, Chamber reverb, Hall reverb, Cabinet, Chorus, Flange, Distortion, and Wah-Wah. The same effect can not be selected twice.

*Effects Checkbox* - You can disable wavetable effects with this checkbox. If effects are disabled, no effects are heard, even if songs request it. This checkbox overrides the slider settings.

*Effect 1 and Effect 2 Sliders* - These sliders increase the amount of effects over the levels set by the MIDI file using controllers 91 and 93 respectively. You can change these settings while a song is playing. A zero setting selects the same amount of effect as set in the song. Moving the sliders up increases the effects level until the effect reaches its maximum possible level. If the song sets the maximum possible effect levels, the sliders have no effect.

**Download**

This button opens a file browser for selecting an alternate instrument set. Press "Open" to download the instruments to the wavetable. The wavetable file must be in DLS format.

After downloading, the new instruments are used instead of the previous instruments. To reload the factory presets, download the file "au10gm.arl" located in the System folder of your Windows directory.

## ❖ Aureal Vortex A3D Settings Tab:

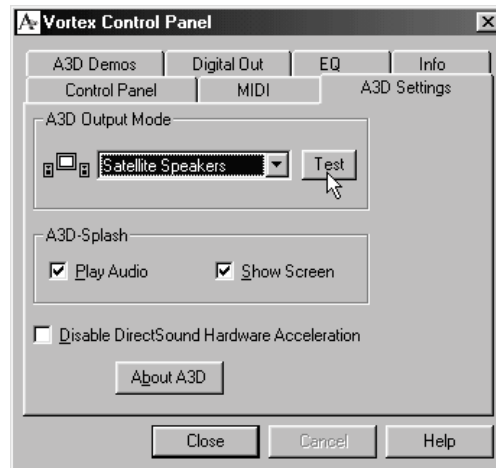

This tab is only visible if your computer supports A3D Interactive real-time positional audio.

**A3D Output Mode**

Select between speaker and headphone output in the list box. This setting only affects output from applications using Aureal's A3D Interactive positional audio technology.

**A3D Splash**

By default, when an A3D-enabled application starts up, the A3D audio signature plays and the A3D logo displays. You can deactivate the audio signature and A3D logo at startup using these checkboxes. (Do not change the splash settings while an A3D application is open.)

**About A3D**

Click on this button for more information on Aureal's A3D Technology.

**Disable DirectSound Hardware Accelerator**

Some games using DirectSound do not check the hardware resources correctly. If no sound is audible, you can disable hardware acceleration of DirectSound with this checkbox. Applications will then use the generic, slower and lower-quality



software DirectSound drivers supplied within DirectX5.0.

- ❖ Aureal Vortex A3D Demos Tab:

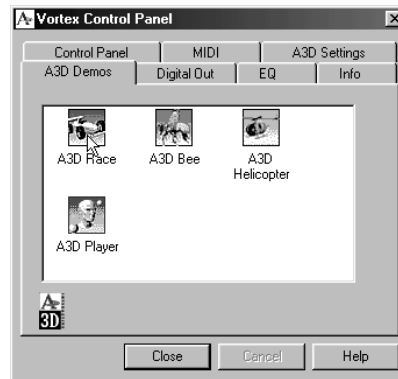

### **A3D Demos**

Click on the icons in this window to launch A3D demo programs.

- ❖ Aureal Vortex Digital Out Tab:

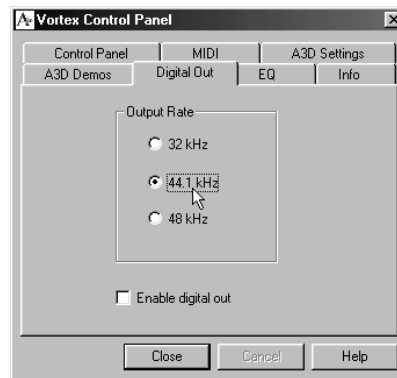

### **Output Rate**

This window allows you to select the sample rate of the S/PDIF output port. When you select a new sample rate, the S/PDIF port uses the new rate immediately.

## ❖ Aureal Vortex EQ Tab:

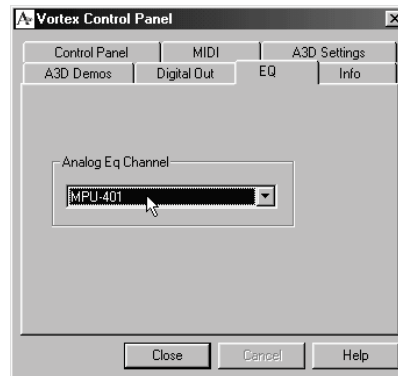
**Analog Eq Channel**

Use this control to select the analog input source for which Tone Controls will be applied.

## ❖ Aureal Vortex Info Tab:

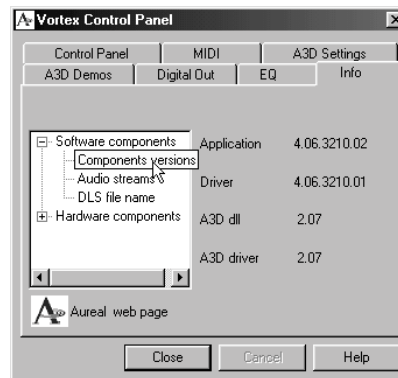
**Vortex Information**

This tab provides information about the Vortex hardware and software capabilities in your system.

## 4. Trouble Shooting

### **PROBLEM**

No power to the system at all. Power light does not illuminate, fan inside power supply does not turn on. Indicator light on keyboard does not turn on.

<b>PROBABLE CAUSE</b>	<b>DIAGNOSIS</b>	<b>SOLUTION</b>
Power cable is unplugged.	Visually inspect power cable.	Make sure power cable is securely plugged in.
Defective power cable.	Visual inspection, try another cable.	Replace cable.
Power supply failure.	Power cable and wall socket are OK, but system is still dead.	Contact technical support.
Faulty wall outlet; circuit Breaker or fuse blown.	Plug in device known to work in socket and test.	Use different socket, repair outlet, reset circuit breaker or replace fuse.

**PROBLEM**

System inoperative. Keyboard lights are on, power indicator lights are lit, hard drive is spinning.

<b>PROBABLE CAUSE</b>	<b>DIAGNOSIS</b>	<b>SOLUTION</b>
Expansion card is partially dislodged from expansion slot on the motherboard.	Turn off computer. Take cover off system unit. Check all expansion cards to ensure they are securely seated in slots.	Using even pressure on both ends of the expansion card, press down firmly on expansion card.
Defective floppy disk drive or tape drive.	Turn system off. Disconnect the cables from one of the floppy drives. Turn on the floppy drives. Turn on the system, check to see if the keyboard operates normally. Repeat until you have located defective unit.	Contact Technical Support.
Defective expansion card.	Turn computer off. Remove an expansion card.	Make sure expansion card is secure in expansion socket.

**PROBLEM**

System does not boot from hard disk drive, can be booted from floppy disk drive.

<b>PROBABLE CAUSE</b>	<b>DIAGNOSIS</b>	<b>SOLUTION</b>
Connector between hard drive and system board unplugged.	When attempting to run the FDISK utility described in the HARD DISK section of this manual you get a message, INVALID DRIVE SPECIFICATION.	Check cable running from disk to disk controller board. Make sure both ends are securely plugged in; check the drive type in the Standard CMOS Setup.
Damaged Hard Disk or Disk Controller.	Format hard disk; if unable to do so the hard disk may be defective.	Contact Technical Support.
Hard Disk directory or FAT is scrambled.	Run the FDISK program, format the hard drive. Copy data that was backed up onto Hard Drive.	Backing up the hard drive is extremely important. All Hard Disk are capable of breaking down at any time.

**PROBLEM**

System only boots from floppy Disk. Hard disk can be read and applications can be used but booting from Hard Disk is impossible.

<b>PROBABLE CAUSE</b>	<b>DIAGNOSIS</b>	<b>SOLUTION</b>
Hard Disk boot program has been destroyed.	A number of causes could be behind this.	Back up data and applications files. Reformat the Hard Drive as described in the Hard Drive section of this manual. Re-install applications and data using backup disks.

**PROBLEM**

Error message reading “SECTOR NOT FOUND” or other error messages not allowing certain data to be retrieved.

<b>PROBABLE CAUSE</b>	<b>DIAGNOSIS</b>	<b>SOLUTION</b>
A number of causes could be behind this.	Use a file by file backup instead of an image backup in order to backup the Hard Disk.	Back up any salvageable data. Then low level format, partition, and high level format the hard drive. Re-install all saved data when completed.

**PROBLEM**

Disk formatted on IBM PS/2 will not operate with this system.

<b>PROBABLE CAUSE</b>	<b>DIAGNOSIS</b>	<b>SOLUTION</b>
The IBM PS/2 uses a different format than other computers.	IBM PS/2 disk format will not work in an AT type computer.	Format disk in the AT type computer insert disk into the IBM PS/2 and copy the files you wish.

**PROBLEM**

After installing an expansion card (network card, tape drive card, etc.) the system no longer works properly.

<b>PROBABLE CAUSE</b>	<b>DIAGNOSIS</b>	<b>SOLUTION</b>
No power to monitor.	All or part of the system may be inoperable. The new card may work but a mouse or COM port may not work.	Change the interrupt or RAM address on the new expansion card. See the documentation that came with the new card in order to change pin settings. Many expansion devices come with proprietary software that will assist you in doing this.

**PROBLEM**

Screen message says "Invalid Configuration" or "CMOS Failure."

<b>PROBABLE CAUSE</b>	<b>DIAGNOSIS</b>	<b>SOLUTION</b>
Incorrect information entered into the configuration (setup) program.	Check the configuration program. Replace any incorrect information.	Review system's equipment . Make sure correct information is in setup.



**PROBLEM**

Screen is blank.

<b>PROBABLE CAUSE</b>	<b>DIAGNOSIS</b>	<b>SOLUTION</b>
No power to monitor.		Check the power connectors to monitor and to system. Make sure monitor is connected to display card, change I/O address on network card if applicable.
Monitor not connected to computer.		See instructions above.
Network card I/O address conflict.		See instructions above.

**PROBLEM**

<b>PROBABLE CAUSE</b>	<b>DIAGNOSIS</b>	<b>SOLUTION</b>
Memory problem, display card jumpers not set correctly.		Reboot computer. Reinstall memory, make sure that all memory modules are installed in correct sockets. Check jumper and switch settings on display card. See display card section for information on settings.
Computer virus.		Use anti-virus programs (McAfee, E-Prot, etc) to detect and clean viruses.

**PROBLEM**

Screen goes blank periodically.

<b>PROBABLE CAUSE</b>	<b>DIAGNOSIS</b>	<b>SOLUTION</b>
Screen saver is enabled.		Disable screen saver.

**PROBLEM**

Keyboard failure.

<b>PROBABLE CAUSE</b>	<b>DIAGNOSIS</b>	<b>SOLUTION</b>
Keyboard is disconnected.		Reconnect keyboard. Check keys again, if no improvement replace keyboard.

**PROBLEM**

No color on screen.

<b>PROBABLE CAUSE</b>	<b>DIAGNOSIS</b>	<b>SOLUTION</b>
Faulty Monitor.		If possible, connect monitor to another system. If no color replace monitor.
CMOS incorrectly set up.		Call technical support.

**PROBLEM**

Floppy drive light stays on.

<b>PROBABLE CAUSE</b>	<b>DIAGNOSIS</b>	<b>SOLUTION</b>
Floppy Drive cable not connected correctly.		Reconnect floppy cable making sure PIN1 on the Floppy Drive corresponds with PIN1 on Floppy cable connector.

**PROBLEM**

Error reading drive A:

<b>PROBABLE CAUSE</b>	<b>DIAGNOSIS</b>	<b>SOLUTION</b>
Bad floppy disk.		Try new floppy disk
Floppy disk not formatted.		Format floppy disk (type FORMAT A: type ENTER).

**PROBLEM**

C: drive failure.

<b>PROBABLE CAUSE</b>	<b>DIAGNOSIS</b>	<b>SOLUTION</b>
SETUP program does not have correct information.		Boot from drive A: using DOS system disk. Input correct information to SETUP program.
Hard Drive cable not connected properly.		Check Hard Drive cable.

**PROBLEM**

Cannot boot system after installing second hard drive.

<b>PROBABLE CAUSE</b>	<b>DIAGNOSIS</b>	<b>SOLUTION</b>
Master/Slave jumpers not set correctly.		Set Master/Slave jumpers correctly.
Hard Drives not compatible / different manufacturers.		Run SETUP program and select correct drive types. Call Drive manufacturers for compatibility with other drives.

**PROBLEM**

Missing operating system on hard drive.

<b>PROBABLE CAUSE</b>	<b>DIAGNOSIS</b>	<b>SOLUTION</b>
CMOS setup has been changed.		Run setup and select correct drive type.

**PROBLEM**

Certain keys do not function.

<b>PROBABLE CAUSE</b>	<b>DIAGNOSIS</b>	<b>SOLUTION</b>
Keys jammed or defective.		Replace keyboard.

**PROBLEM**

Keyboard is locked, no keys function.

<b>PROBABLE CAUSE</b>	<b>DIAGNOSIS</b>	<b>SOLUTION</b>
Keyboard is locked.		Unlock keyboard.

09/06/1999  
MADE IN TAIWAN  
R.O.C