Federal Communications Commission (F.C.C) Statement

This device complies with Part 15 of the FCC Rules. Operation of this device is subject to the following two conditions: (1) this device may not cause harmful interference, and (2) this device must accept any interference received, including interference that may cause undesired operation.

Accessories: This device has been tested and found to comply with the limits of a Class B digital device, the accessories associated with this equipment are as follows:

1. Shielded serial cable. (Can be obtained from multiple retail outlets)
2. Shielded printer cable. (Can be obtained from multiple retail outlets)
3. Shielded video cable. (Can be obtained from multiple retail outlets)
4. Shielded power cord. (Provided by manufacturer)

These accessories are required to be used in order to ensure compliance with FCC Rules. It is the responsibility of the user to provide and use these accessories properly.

This equipment has been tested and found to comply with the limits of a Class B digital device, pursuant to Part 15 of the FCC Rules. These limits are designed to provide reasonable protection against harmful interference in a residential installation. This equipment generates, uses and can radiate radio frequency energy and, if not installed and used in accordance with the instructions, may cause harmful interference to radio communications. However, there is no guarantee that interference will not occur in a particular installation. If this equipment does cause harmful interference to radio or television reception, which can be determined by turning the equipment off and on, the user is encouraged to try to correct the interference by one or more of the following measures:

1. Reorient / Relocate the receiving antenna.
 2. Increase the separation between the equipment and receiver.
 3. Connect the equipment into an outlet on a circuit different from that to which the receiver is connected.
-

4. Consult the dealer or an experienced radio/TV technician for help.

Caution: Changes or modifications not expressly approved by the manufacturer could void the user's authority to operate the equipment.

Disclaimer

The Vendor makes no representations or warranties with respect to the contents here of and specially disclaims any implied warranties of merchantability or fitness for any purpose. Further the Vendor reserves the right to revise this publication and to make changes from time to time in the contents here of without obligation to notify any party beforehand. Duplication of this publication, in part or in whole, is not allowed without first obtaining the Vendor's approval in writing.

Trademarks and Remarks

MS-DOS, Windows, Windows NT, and Windows 9x are products of Microsoft Corp, with its ownership of trademark, and are distributed by the Vendor under a license agreement.

All trademarks used in this manual are the property of their respective owners.

Copyright(C) 1992
All Rights Reserved

Canadian D.O.C. Statement

This digital apparatus does not exceed the Class B limits for radio noise emissions from digital apparatus as set out in the radio interference regulations of the Canadian Department of Communications.

Cet appareil numérique n'émet pas de bruits radioélectriques dépassant les limites appliqués aux appareils numériques de Class B prescrits dans le règlement du brouillage radioélectrique édicté par le ministère Des Communications du Canada.

Introduction	1-1
1 Motherboard Description	1-2
1.1 Features	1-2
1.1.1 Hardware	1-2
1.1.2 Software	1-7
1.1.3 Attachments	1-7
1.2 Motherboard Installation	1-8
1.2.1 Layout of Motherboard	1-8
1.3 Motherboard Connectors	1-9
1.3.1 Front Panel Connectors (PANEL1)	1-10
1.3.2 ATX 20-pin Power Connector : POWER1	1-13
1.3.3 Hard Disk Connectors : IDE1 / IDE2	1-14
1.3.4 Floppy Disk Connector : FDD1	1-14
1.4 Back Panel Connectors	1-15
1.4.1 PS/2 Mouse / Keyboard Connector : CN1	1-15
1.4.2 USB Connectors : USB1	1-16
1.5 Serial and Parallel Interface Ports	1-18
1.6 CPU Installation	1-22
1.6.1 CPU Installation Procedure : Socket 370	1-22
1.6.2 CPU Frequency Selection : JP1	1-23
1.6.3 CPU Ratio Selection : JFREQ1	1-24
1.7 Jumper Settings	1-25
1.7.1 System Fan Connector: J5	1-26

Contents

1.7.2 Wake-On-LAN Connector: JWOL1	1-26
1.7.3 Wake-On-Modem Connector: JWOM1 (Optional)	1-26
1.7.4 CPU Fan Connector: J6	1-26
1.7.5 CMOS Function Selection: JBAT1	1-27
1.8 DRAM Installation	1-28
1.8.1 DIMM	1-28
1.8.2 How to install a DIMM Module	1-30
1.9 Audio Subsystem	1-31
1.9.1 CD Audio-In Connectors: J7/J8	1-32
1.9.2 Telephony Connector: J9	1-32
1.9.3 AUX Audio in Connector: J10 (Optional)	1-32
2. BIOS Setup	2-1
2.1 Main Menu	2-3
2.2 Standard CMOS Features	2-5
2.3 Advanced BIOS Features	2-8
2.4 Advanced Chipset Features	2-13
2.5 Integrated Peripherals	2-16
2.6 Power Management Setup	2-21
2.7 PnP/PCI Configurations	2-25
2.8 PC Health Status	2-29
2.9 Load Optimized Defaults	2-30
2.10 Set Supervisor/User Password	2-31
2.11 Save & Exit Setup	2-33
2.12 Exit Without Saving	2-34

3. Software Setup	3-1
3.1 Software List.....	3-1
3.2 Software Installation	3-2
3.3 Using Software.....	3-3
4. Trouble Shooting	4-1

Introduction

System Overview

Thanks for buying this product! This manual was written to help you start using this product as quickly and smoothly as possible. Inside you will find adequate explanations to solve most problems. In order for this reference material to be of greatest use, refer to the “expanded table of contents” to find relevant topics.

This board incorporates the all new VIA694X/686A serial chipset, AGP and PCI IDE into one board that provides a total PC solution. The motherboard, a Celeron™ / Pentium®!!!, processor based PC/Micro ATX system, supports 128KB or 256KB cache on CPU, PCI Local Bus to support upgrades to your system performance. On-Board Sound Subsystem to support high 3D sound quality, the AMR Slot to support the solution of high performance, low cost modem. It is ideal for multi-tasking and fully supports MS-DOS, Windows 3x, Windows NT, Windows 2000, Novell, OS/2, Windows9x, UNIX, SCO UNIX etc. This manual also explains how to install the motherboard for operation, and how to setup your CMOS configuration with the BIOS setup program.

1 Motherboard Description

1.1 Features

1.1.1 Hardware

CPU

- The Celeron™ processor (PPGA) Coppermine (FC-PGA) Micro-Processor provides the new generation power for high-end workstations and servers.
- Provides Socket 370.
- Running at 66/100 or 133MHz Front Side Bus frequency.

Speed

- Supports from 233MHz to 733MHz CPU core speeds.
- Supports 33 MHz PCI Bus speed.

DRAM Memory

- Supports two 8/16/32/64/128/256MB DIMM module sockets.
- Supports Synchronous DRAM (3.3V).
- Supports a maximum memory size of 768 MB with SDRAM.
- 133MHz Bus frequency.

Shadow RAM

- A memory controller that provides shadow RAM.

Green Function

- Supports power management operation via BIOS.
- Power down timer from 1 min to 1 hour.
- Wakes up by any key pressed or mouse activity.
- Wake On LAN connector.

BUS Slots

- Provide one AGP (2X /4X) slot .
- Two 32-bit PCI bus master slots.
- PCI V2.2 compliant.

PCI Enhanced IDE Built-in onboard

- Supports 4 IDE hard disk drives.
- Supports Mode 4, bus master mode, high performance hard disk drives.
- Supports Ultra DMA33/66, bus master mode.
- Supports IDE interface with CD-ROM.
- Supports high capacity hard disk drives.
- Supports LBA mode.
- Supports booting from LS-120 or ZIP disk.

PCI-Based AC 97 Digital Audio Processor

- 64 voice wavetable synthesis.
- DOS Game Compatibility.
- Uses a single sharable PCI Interrupt.
- Multiple sample rate support.
- CD audio over the PCI bus.
- Tone Control.
- Speaker EQ.
- PCI Bus Master for fast DMA.
- Sounds are stored in Host memory.
- Sound Library of over 4000 Sounds.
- 3 Stereo inputs and 3 mono inputs can be mixed into the output stream.
- Direct I/O space access of the control registers.
- Fully Compliant with PC97 Power Managment specification.

Super I/O Built-in onboard

- Support one multi-mode Parallel Port.
 - (1) Standard & Bidirection Parallel Port (SPP).
 - (2) Enhanced Parallel Port (EPP).
 - (3) Extended Capabilities Port (ECP).
- Supports two serial ports, 16550 UART with 16 byte FIFO.
- UART data rates up to 1.5 Mbaud.
- Supports one Infrared transmission (IR) port.
- Supports PS/2 Mouse.
- Supports 360KB, 720KB, 1.2MB, 1.44MB and 2.88MB floppy disk drives.

Direct Sound Ready AC97 Digital Audio Controller

- Dual full-duplex Direct Sound channels between system memory and AC97 link.
- PCI master interface with scatter / gather and bursting capability.
- 32 byte FIFO of each direct sound channel.
- Host based sample rate converter and mixer.
- Standard v1.0 or v2.0 AC97 Codec interface for single or cascaded AC97 Codec's from multiple vendors.
- Loopback capability for re-directing mixed audio streams into USB and 1394 speakers.
- Hardware SoundBlaster Pro for Windows DOS box and real-mode Dos legacy compatibility.
- Plug and play with 4 IRQ, 4 DMA, and 4 I/O space options for SoundBlaster Pro and MIDI hardware.
- Hardware assisted FM synthesis for legacy compatibility.
- Direct two game ports and one MIDI port interface.
- Complete software driver support for Windows-95, Windows-98, Windows-NT and Windows 2000.

Power Management

- Supports both ACPI (Advanced Configuration and Power Interface) and legacy (APM) power management.
- ACPI v1.0 Compliant.
- APM v1.2 Compliant.
- CPU clock throttling and clock stop control for complete ACPI C0 to C3 state support.
- PCI bus clock run, Power Management Enable (PME) control, and PCI/CPU clock generator stop control.
- Supports multiple system suspend types: power-on suspends with flexible CPU/PCI bus reset options and suspend to disk (soft-off), all with hardware automatic wake-up.
- Multiple suspend power plane controls and suspend status indicators.
- One idle timer, one peripheral timer and one general purpose timer, plus 24/32-bit ACPI compliant timer.
- Normal, doze, sleep, suspend, and conserve modes.
- Global and local device power control.
- System event monitoring with two event classes.
- Primary and secondary interrupt differentiation for individual channels.
- Dedicated input pins for power and sleep buttons, external modem ring indicator, and notebook lid open/close for system wake-up.
- Multiple internal and external SMI sources for flexible power management models.
- One programmable chip select and one microcontroller chip select.
- Enhanced integrated real time clock (RTC) with date alarm, month alarm, and century field.
- Thermal alarm on either external or any combination of two internal temperature sensing circuits.
- Hot docking support.
- I/O pad leakage control.

Universal Serial Bus

- USB v.1.1 and Intel Universal HCI v.1.1 compatible.
- Eighteen level (doublewords) data FIFO with full scatter and gather capability.
- Root hub and four function ports.
- Integrated physical layer transceivers with optional over-current detection status on USB inputs.
- Keyboard and mouse support.

Platform

- Micro ATX Form Factor.

Dimension

- 21.3 cm X 24.5 cm (W x L).

Full Featured Accelerated Graphics Port (AGP) Controller

- Synchronous and pseudo-synchronous with the CPU bus with optimal skew control.
- AGP v2.0 compliant.
- Supports SideBand Addressing (SBA) mode (non-multiplexed address / data).
- Supports 266 MHz 4x mode for AD and SBA signaling.
- Pipelined split-transaction long-burst transfers up to 1GB /sec.
- Eight level read request queue.
- Four level posted-write request queue.
- Thirty-two level (quadwords) read data FIFO (256 bytes).
- Sixteen level (quadwords) write data FIFO (128 bytes).
- Intelligent request reordering for maximum AGP bus utilization.
- Supports Flush/Fence commands.
- Graphics Address Relocation Table (GART).
 - (1) One level TLB structure.
 - (2) Sixteen entry fully associative page table.
 - (3) LRU replacement scheme.
 - (4) Independent GART lookup control for host /AGP /PCI master accesses.

- Windows 95 OSR-2 VXD and integrated Windows 98 / NT2000 /WINNT miniport driver support.

1.1.2 Software

BIOS

- AWARD legal & user-friendly BIOS.
- Supports PnP functions.

Operating Systems

- Offers the highest performance for MS-DOS OS/2, Windows NT, Windows 2000, Windows 31 / 95 / 98, Novell, UNIX, SCO UNIT, and others.

1.1.3 Attachments

- HDD Cable.
- FDD Cable.
- USB2 Cable (Optional).
- CD for IDE / AGP / Chipset Driver, BIOS flash writer utility, Audio Driver.

1.2 Motherboard Installation

1.2.1 Layout of Motherboard

Model No.M6VCF

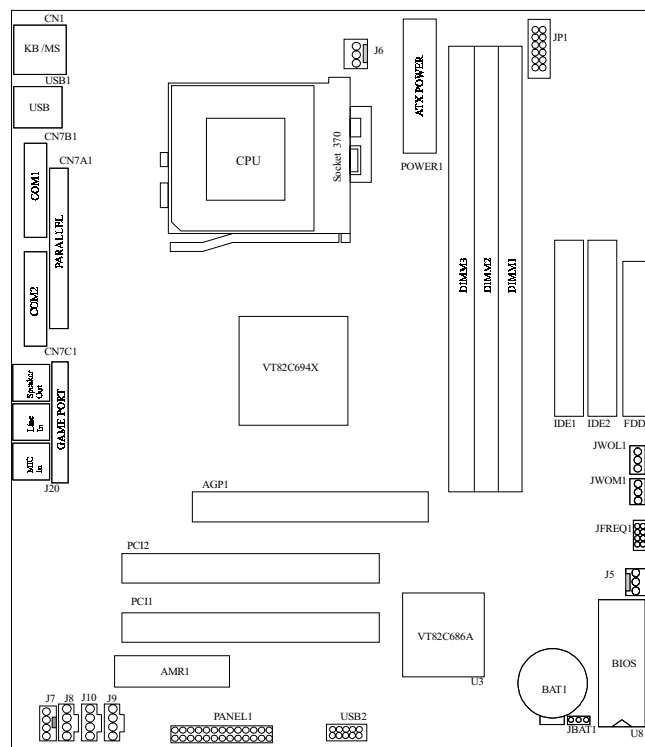

NOTES: After version 1.0, the ATX POWER (POWER1) will be removed just beside the KB/MS (CN1) & USB (USB1) port. (in vertical position)

1.3 Motherboard Connectors

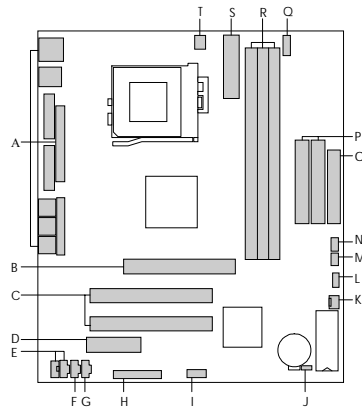

- | | |
|---|--|
| A. Back Panel I/O connectors | L. Ratio Selection (JFREQ1) |
| B. AGP Slot (AGP1) | M. Wake-On Modem connector (JWOM1) (optional) |
| C. PCI Bus Slots (PCI1-2) | N. Wake-On LAN conn. (JWOL1) |
| D. AMR Slot (AMR1) | O. FDD connector (FDD1) |
| E. CD Audio-IN connector (J7,J8) | P. IDE connectors (IDE1/IDE2) |
| F. AUX Audio in conn. (J10) (optional) | Q. Frequency Selection (JP1) |
| G. Telephony connector (J9) | R. DIMMs socket (DIMM1-3) |
| H. Front Panel connector(PANEL1) | S. ATX Power connector (POWER1) |
| I. Front USB (USB2) | T. CPU Fan connector (J6) |
| J. CMOS Function Select (JBAT1) | |
| K. System Fan connector (J5) | |

NOTES: After version 1.0, the ATX POWER (POWER1) will be removed just beside the KB/MS (CN1) & USB (USB1) port. (in vertical position)

1.3.1 Front Panel Connectors (PANEL1)

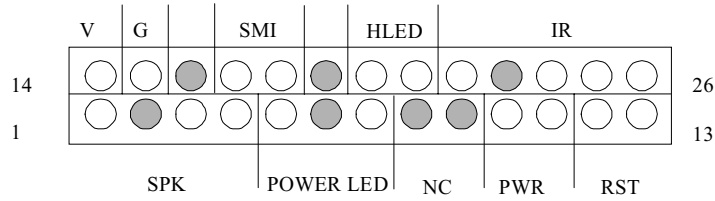

Pin No.	Assignment	Function	Pin No.	Assignment	Function
1	Speaker	Speaker Connector	14	+5V	VCC
2	NC		15	Ground	Ground
3	Ground		16	NC	NC
4	+5V		17	Sleep Switch	SMI
5	Power LED(+)	18	Ground		
6	NC	Power LED	19	NC	NC
7	Ground		20	HDD LED(-)	HDD LED
8	NC	No Function	21	HDD LED(+)	
9	NC		22	+5V	IrDA Connector
10	Power Switch		23	NC	
11	Ground	24	IRRX		
12	Reset Switch	25	Ground		
13	Ground	26	IRTX		

Speaker Connector

An offboard speaker can be installed on the motherboard as a manufacturing option. An offboard speaker can be connected to the motherboard at the front panel connector. The speaker (onboard or offboard) provides error beep code information during the Power On Self-Test when the computer cannot use the video interface. The speaker is not connected to the audio subsystem and does not receive output from the audio subsystem.

Reset Button

This connector can be connected to a momentary SPST type switch that is normally open. When the switch is closed, the motherboard resets and runs the POST.

Power LED Connector

This connector can be connected to an LED that will light when the computer is powered on.

Hard Drive LED Connector

This connector can be connected to an LED to provide a visual indicator that data is being read from or written to a hard drive. For the LED to function properly, an IDE drive must be connected to the onboard hard drive controller.

Infrared Connector

After the IrDA interface is configured, files can be transferred from or to portable devices such as laptops, PDAs, and printers using application software.

SMI (Sleep/Resume Switch)

When APM is enabled in the system BIOS, and the operating system's APM driver is loaded, the system can enter sleep (standby) mode in one of the following ways:

- Optional front panel SMI button
 - Prolonged system inactivity using the BIOS inactivity timer feature
- The 2-pin header located on the front panel I/O connector supports a front panel SMI switch, which must be a momentary SPST type that is normally open. Closing the SMI switch sends a System Management Interrupt (SMI) to the processor, which immediately goes into System Management Mode (SMM). While the computer is in sleep mode it is fully capable of responding to and servicing external interrupts (such as an incoming fax) even though the monitor turns on only if a keyboard or mouse interrupt occurs. To reactivate or resume the system, the SMI switch must be pressed again, or the keyboard or mouse must be used.

Power On Button

This connector can be connected to a front panel power switch. The switch must pull the Power Button pin to ground for at least 50 ms to signal the power supply to switch on or off. (The time requirement is due to internal denounce circuitry on

the motherboard). At least two seconds must pass before the power supply will recognize another on/off signal.

1.3.2 ATX 20-pin Power Connector : POWER1

This connector supports the power button on-board. Using the ATX power supply, functions such as Modem Ring Wake-Up and Soft Power Off are supported on this motherboard. This power connector supports instant power-on functionality, which means that the system will boot up instantly when the power connector is inserted on the board.

PIN	VOLTAGE	PIN	VOLTAGE
1	3.3 V	11	3.3 V
2	3.3 V	12	-12 V
3	GND	13	GND
4	5 V	14	PS_ON
5	GND	15	GND
6	5 V	16	GND
7	GND	17	GND
8	PW_OK	18	-5 V (Optional)
9	5V_SB	19	5 V
10	12 V	20	5 V

Warning: Since the motherboard has the instant power on function, make sure that all components are installed properly before inserting the power connector to ensure that no damage will be done.

1.3.3 Hard Disk Connectors: IDE1 / IDE2

The motherboard has a 32-bit Enhanced PCI IDE Controller that provides PIO Mode 0~4, Bus Master, and Ultra DMA 33 / 66 functionality. It has two HDD connectors IDE1 (primary) and IDE2 (secondary). You can connect up to four hard disk drives, a CD-ROM, a 120MB Floppy (reserved for future BIOS) and other devices to IDE1 and IDE2. These connectors support the IDE hard disk cable provided.

- **IDE1 (Primary IDE Connector)**

The first hard drive should always be connected to IDE1. IDE1 can connect a Master and a Slave drive. You must configure the second hard drive on IDE1 to Slave mode by setting the jumper accordingly.

- **IDE2 (Secondary IDE Connector)**

The IDE2 controller can also support a Master and a Slave drive. The configuration is similar to IDE1. The second drive on this controller must be set to slave mode.

1.3.4 Floppy Disk Connector: FDD1

The motherboard provides a standard floppy disk connector (FDC) that supports 360K, 720K, 1.2M, 1.44M and 2.88M floppy disk types. This connector supports the provided floppy drive ribbon cables.

1.4 Back Panel Connectors

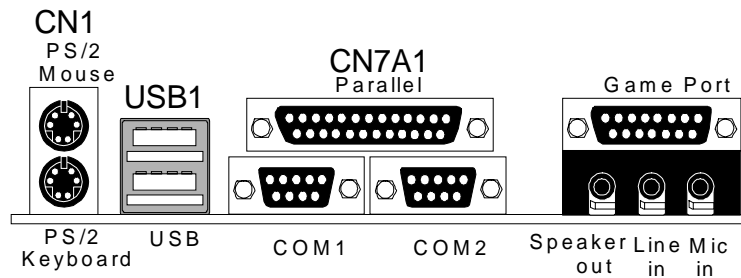

1.4.1 PS/2 Mouse / Keyboard Connector : CN1

The motherboard provides a standard PS/2 mouse / Keyboard mini DIN connector for attaching a PS/2 mouse. You can plug a PS/2 mouse / Keyboard directly into this connector. The connector location and pin definition are shown below:

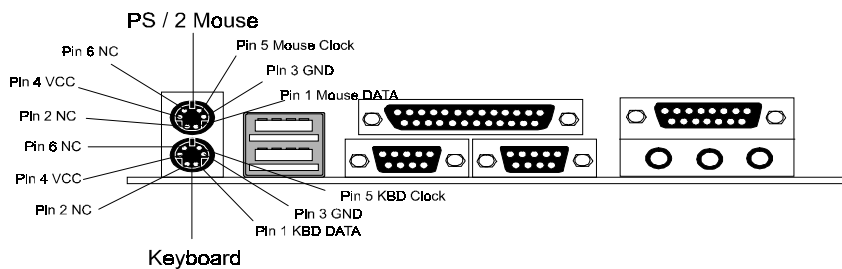

PS/2 Mouse / Keyboard Connectors

Pin	Signal Name
1	Data
2	No connect
3	Ground
4	+5 V (fused)
5	Clock
6	No connect

1.4.2 USB Connectors : USB1

The motherboard provides a UHCI (Universal Host Controller Interface) Universal Serial Bus Roots for attaching USB devices such as keyboard, mouse and other USB devices. You can plug the USB Devices directly into this connector.

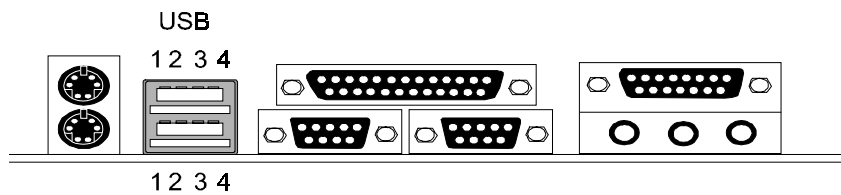
USB1**Stacked USB Connectors**

Pin	Signal Name
1	+5 V (fused)
2	USBP0- [USBP1-]
3	USBP0+ [USBP1+]
4	Ground

Note: (1) Signal names in brackets ([]) are for USB port 1.

Front USB Connector (USB2)

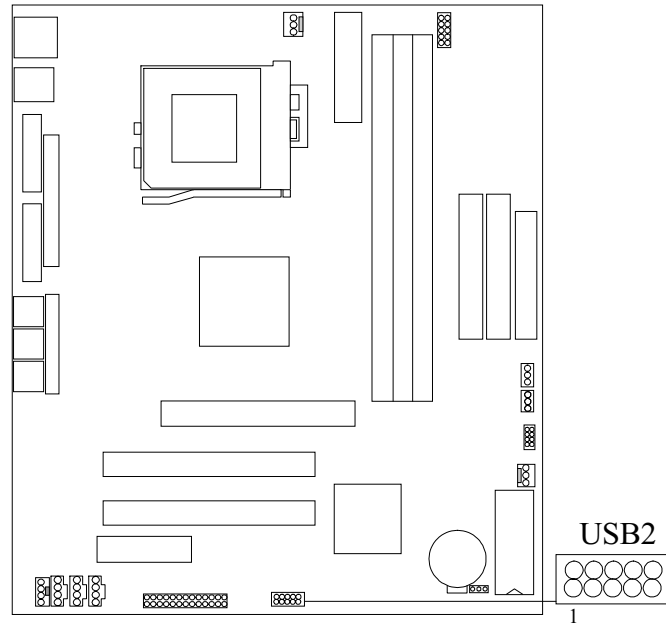

Pin	Signal Name	Pin	Signal Name
1	+5V	2	Ground
3	USBP2-	4	Ground
5	USBP2+	6	USBP3+
7	Ground	8	USBP3-
9	Ground	10	+5V

NOTES: After version 1.0, the ATX POWER (POWER1) will be removed just beside the KB/MS (CN1) & USB (USB1) port. (in vertical position)

1.5 Serial and Parallel Interface Ports

This system comes equipped with two serial ports and one parallel port. Both types of interface ports will be explained in this chapter.

The Serial Interface : COM1,COM2

The serial interface port is sometimes referred to as an RS-232 port or an asynchronous communications port. Mice, printers, modems and other peripheral devices can be connected to a serial port. The serial port can also be used to connect your computer with another computer system. If you wish to transfer the contents of your hard disk to another system it can be accomplished by using each machine's serial port.

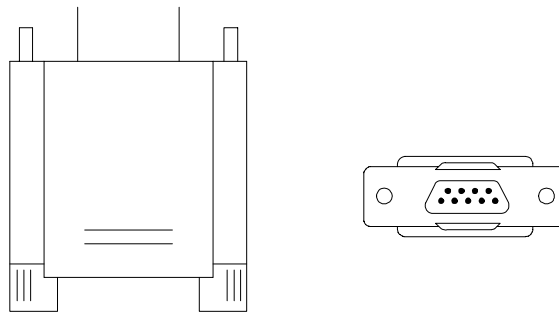

The serial ports on this system has two 9-pin connector. Some older computer systems and peripherals used to be equipped with only one 25-pin connector. As you need to connect your 9-pin serial port to an older 25-pin serial port, you can purchase a 9-to-25 pin adapter.

Connectivity

The serial port can be used many ways, and it may be necessary to become familiar with the pin-out diagram. The following chart gives you the function of each pin on the 9-pin connector and some of the 25-pin connector. This information can be used when configuring certain software programs to work with the serial port.

Signal	Name	DB9 PIN	DB25 PIN
DCD	Data Carrier Detect	1	8
RX	Receive Data	2	3
TX	Transmit Data	3	2
DTR	Data Terminal Ready	4	20
GND	Signal Ground	5	7
DSR	Data Set Ready	6	6
RTS	Request to Send	7	4
CTS	Clear to Send	8	5
RI	Ring Indicator	9	22

Special Applications

There are two types of serial devices that can be connected to a serial port. One of the devices is called "DTE" (Data Terminal Equipment) and the other device is called "DCE" (Data Communications Equipment). If a modem is connected to a computer, for example, the modem is called the DCE and the computer is called the DTE. In situations such as this, the pins on the serial ports can be connected straight through.

In instances when there are two DTE devices connected together, such as a computer and a printer, a special adapter called a "Null Modem" is needed to make communication between the two devices possible.

When using the serial port to communicate between devices, one problem in particular may arise. Some manufacturers use one set of signals to begin communication with another device and other manufacturers do not use these

signals to initiate communication. If you encounter a communication problem that cannot be resolved using a null modem, it can generally be assumed that one device is using the initialization signals and the other device is not. This can usually be resolved by wiring the RTS, CTS, and DCD pins together.

Serial Ports/COM Ports

The two serial ports on the computer are called COM1 and COM2, respectively. If you wish, two more serial ports can be added onto the computer using optional hardware. Should you choose to add the extra Serial ports (COM ports) they would be called COM3 and COM4.

When using serial ports to communicate with a peripheral device, be sure to assign only one COM port number to each device. For example, if a printer and a scanner are both connected to your computer through serial ports, the printer must be assigned one COM port (i.e. COM1) and the scanner must be assigned the other COM port (i.e. COM2). No two devices can be assigned to one COM port. Each peripheral must have its own COM port.

NOTE: Four serial ports may be installed on the computer. However, no more than two ports can be used simultaneously.

*If you have installed an internal modem, be careful not to assign a COM port number that has already been assigned to another device. This error is common.

When installing a device that is going to require the use of a serial port, use a diagnostic program to find out which ports are available. It may be necessary to remove expansion cards that have serial ports in order to check their jumper settings. The jumper settings will indicate which COM port the card has been assigned. Checking the expansion card will eliminate mistakes in overlapping COM ports. Once you have completed the installation of peripheral devices using the serial ports, be sure that the communication parameters such as baud rate, parity bit, etc. are matching. If your computer is set for a baud rate of 9600 and your modem is set for a baud rate of 2400 you will not be able to send messages. The manuals that accompany the peripheral devices will inform you on the procedure for setting their parameters. Software manuals also have instructions on setting parameters.

Parallel Interface Port : CN7A1

Unlike the serial port, parallel interface ports have been standardized and should not present any difficulty interfacing peripherals to your system. Sometimes called a Centronics port, the parallel port is almost exclusively used with printers. The parallel port on your system has a 25-pin, DB5 connector (see picture below). The pin-out for the parallel port are shown in the table below.

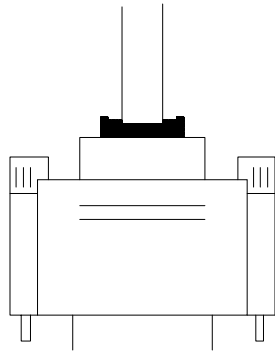
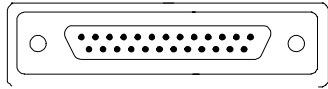

Signal	Pin
-Strobe	1
Data 0	2
Data 1	3
Data 2	4
Data 3	5
Data 4	6
Data 5	7
Data 6	8
Data 7	9
-Ack	10
Busy	11
Paper Empty	12
+Select	13
-Auto FDXT	14
-Error	15
-Init	16
-SLCTN	17
Ground	18
Ground	19
Ground	20
Ground	21
Ground	22
Ground	23
Ground	24
Ground	25

1.6 CPU Installation

1.6.1 CPU Installation Procedure : Socket 370

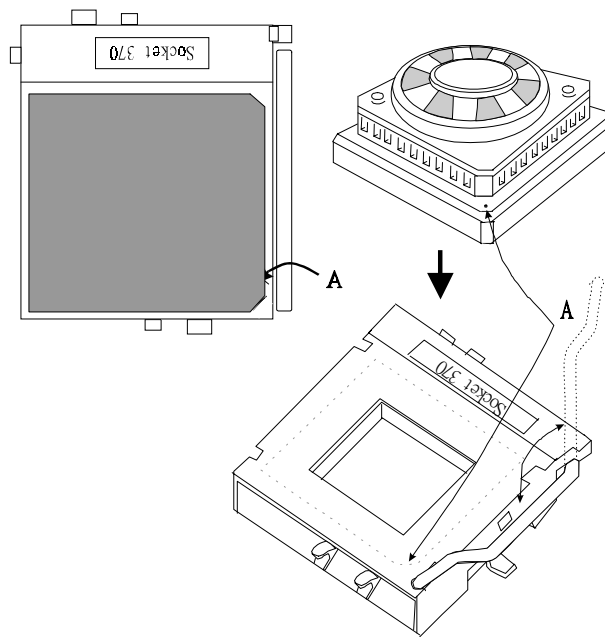

1. Pull the lever sideways away from the socket then raise the lever up to a 90-degree angle.
2. Locate Pin A in the socket and look for the white dot or cut edge in the CPU. Match Pin A with the white dot/cut edge then insert the CPU.
3. Press the lever down to complete the installation.

1.6.2 CPU Frequency Selection : JP1

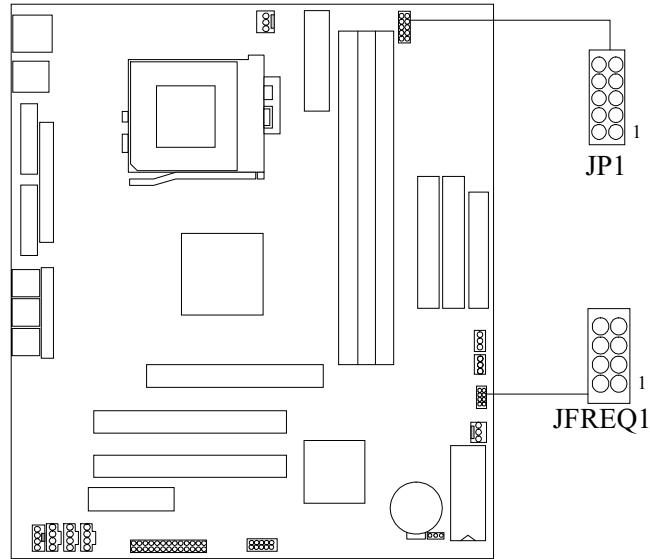

JP1 FREQ.	1	2	3	4	5	6
66MHz	OPEN	OPEN	CLOSE	CLOSE	CLOSE	CLOSE
100MHz	OPEN	OPEN	OPEN	CLOSE	OPEN	CLOSE
133MHz	OPEN	OPEN	OPEN	OPEN	CLOSE	OPEN

NOTES: After version 1.0, the ATX POWER (POWER1) will be removed just beside the KB/MS (CN1) & USB (USB1) port. (in vertical position)

1.6.3 CPU Ratio Selection : JFREQ1

JFREQ1 RATIO	1	2	3	4
x 2.0	CLOSE	CLOSE	CLOSE	CLOSE
x 2.5	CLOSE	CLOSE	OPEN	CLOSE
x 3.0	CLOSE	OPEN	CLOSE	CLOSE
x 3.5	CLOSE	OPEN	OPEN	CLOSE
x 4.0	OPEN	CLOSE	CLOSE	CLOSE
x 4.5	OPEN	CLOSE	OPEN	CLOSE
x 5.0	OPEN	OPEN	CLOSE	CLOSE
x 5.5	OPEN	OPEN	OPEN	CLOSE
x 6.0	CLOSE	CLOSE	CLOSE	OPEN
x 6.5	CLOSE	CLOSE	OPEN	OPEN
x 7.0	CLOSE	OPEN	CLOSE	OPEN
x 7.5	CLOSE	OPEN	OPEN	OPEN
x 8.0	OPEN	CLOSE	CLOSE	OPEN

1.7 Jumper Settings

The jumper has two or more pins, which may be covered by a plastic jumper cap, allowing you to select different system options.

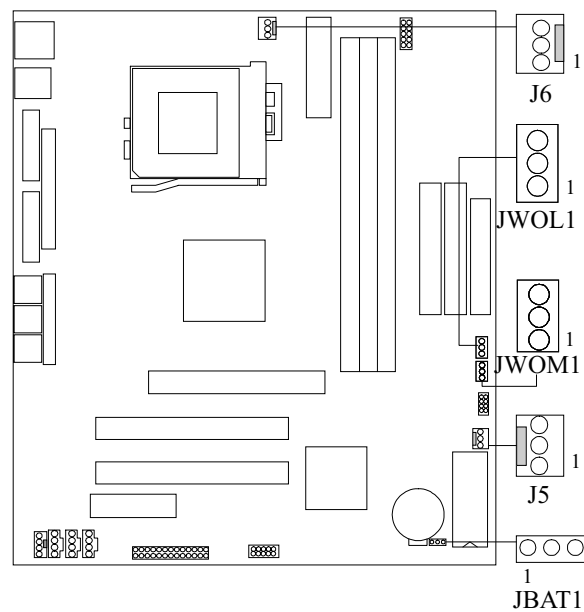

NOTES: After version 1.0, the ATX POWER (POWER1) will be removed just beside the KB/MS (CN1) & USB (USB1) port. (in vertical position)

1.7.1 System Fan Connector: J5

Pin No.	Assignment
1	Sense
2	+12 V
3	Control Signal

1.7.2 Wake-On-LAN Connector: JWOL1

Pin No.	Assignment
1	5V_SB
2	Ground
3	Wake-up

1.7.3 Wake-On-Modem Connector: JWOM1(Optional)

Pin No.	Assignment
1	5V_SB
2	Ground
3	Ring

1.7.4 CPU Fan Connector: J6

Pin No.	Assignment
1	Sense
2	+12 V
3	Control Signal

1.7.5 CMOS Function Selection: JBAT1

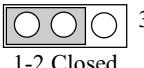
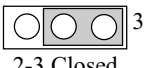
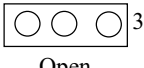
JBAT1	Assignment
 1-2 Closed	Normal Operation (default)
 2-3 Closed	Clear CMOS Data (*Note)
 Open	Onboard Battery Disabled

Note: Please follow the procedure as below to clear CMOS Data.

Note: Please follow the procedure as below to clear BIOS Password if your password is lost or forgotten.

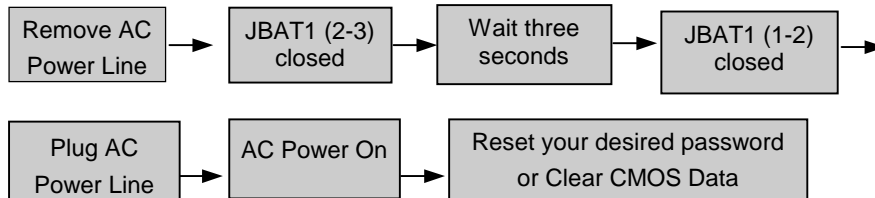

1.8 DRAM Installation

1.8.1 DIMM

DRAM Access Time: 3.3V Unbuffered SDRAM PC66/ PC100 / PC133 Type required.

DRAM Type: 8MB/16MB/32MB/64MB/128MB/256MB DIMM Module (168pin)

Total Memory Size (MB)	Bank 0 DIMM1	Bank 1 DIMM2	Bank 2 DIMM3
8 M	8M x 1 pc	----	----
16 M	16M x 1 pc	----	----
32 M	32M x 1 pc	----	----
64 M	64M x 1 pc	----	----
128 M	128M x 1 pc	----	----
256 M	256M x 1 pc	----	----
16 M	8M x 1 pc	8M x 1 pc	----
32 M	16M x 1 pc	16M x 1 pc	----
64 M	32M x 1 pc	32M x 1 pc	----
128 M	64M x 1 pc	64M x 1 pc	----
256 M	128M x 1 pc	128M x 1 pc	----
512 M	256M x 1 pc	256M x 1 pc	----
24 M	8M x 1 pc	8M x 1 pc	8M x 1 pc
40 M	16M x 1 pc	16M x 1 pc	8M x 1 pc
72 M	32M x 1 pc	32M x 1 pc	8M x 1 pc
136 M	64M x 1 pc	64M x 1 pc	8M x 1 pc
264 M	128M x 1 pc	128M x 1 pc	8M x 1 pc
520 M	256M x 1 pc	256M x 1 pc	8M x 1 pc
32 M	8M x 1 pc	8M x 1 pc	16M x 1 pc
48 M	16M x 1 pc	16M x 1 pc	16M x 1 pc
80 M	32M x 1 pc	32M x 1 pc	16M x 1 pc
144 M	64M x 1 pc	64M x 1 pc	16M x 1 pc
272 M	128M x 1 pc	128M x 1 pc	16M x 1 pc
528 M	256M x 1 pc	256M x 1 pc	16M x 1 pc
48 M	8M x 1 pc	8M x 1 pc	32M x 1 pc
64 M	16M x 1 pc	16M x 1 pc	32M x 1 pc
96 M	32M x 1 pc	32M x 1 pc	32M x 1 pc
160 M	64M x 1 pc	64M x 1 pc	32M x 1 pc
288 M	128M x 1 pc	128M x 1 pc	32M x 1 pc
544 M	256M x 1 pc	256M x 1 pc	32M x 1 pc
80 M	8M x 1 pc	8M x 1 pc	64M x 1 pc
96 M	16M x 1 pc	16M x 1 pc	64M x 1 pc
128 M	32M x 1 pc	32M x 1 pc	64M x 1 pc
192 M	64M x 1 pc	64M x 1 pc	64M x 1 pc
320 M	128M x 1 pc	128M x 1 pc	64M x 1 pc
576 M	256M x 1 pc	256M x 1 pc	64M x 1 pc

Total Memory Size (MB)	Bank 0 DIMM1	Bank 1 DIMM2	Bank 2 DIMM3
144 M	8M x 1 pc	8M x 1 pc	128M x 1 pc
160 M	16M x 1 pc	16M x 1 pc	128M x 1 pc
192 M	32M x 1 pc	32M x 1 pc	128M x 1 pc
256 M	64M x 1 pc	64M x 1 pc	128M x 1 pc
384 M	128M x 1 pc	128M x 1 pc	128M x 1 pc
640 M	256M x 1 pc	256M x 1 pc	128M x 1 pc
272 M	8M x 1 pc	8M x 1 pc	256M x 1 pc
288 M	16M x 1 pc	16M x 1 pc	256M x 1 pc
320 M	32M x 1 pc	32M x 1 pc	256M x 1 pc
384 M	64M x 1 pc	64M x 1 pc	256M x 1 pc
512 M	128M x 1 pc	128M x 1 pc	256M x 1 pc
768 M	256M x 1 pc	256M x 1 pc	256M x 1 pc

*The list shown above for DRAM configuration is only for reference.

1.8.2 How to install a DIMM Module

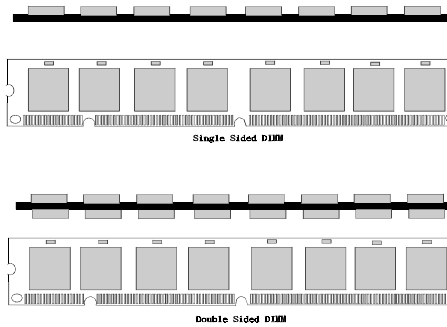

1. The DIMM socket has a "Plastic Safety Tab" and the DIMM memory module has an "asymmetrical notch", so the DIMM memory module can only fit in one direction.

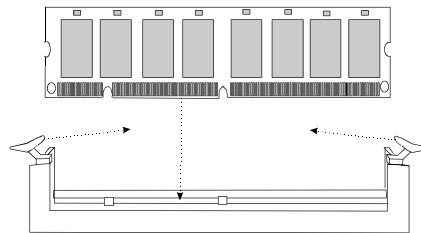

2. Push the tabs out. Insert the DIMM memory modules into the socket at 90-degree angle then push down vertically so that it will fit into place.

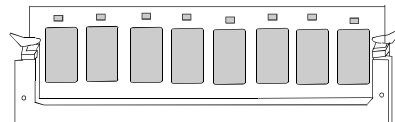

3. The Mounting Holes and plastic tabs should fit over the edge and hold the DIMM memory modules in place.

1.9 Audio Subsystem

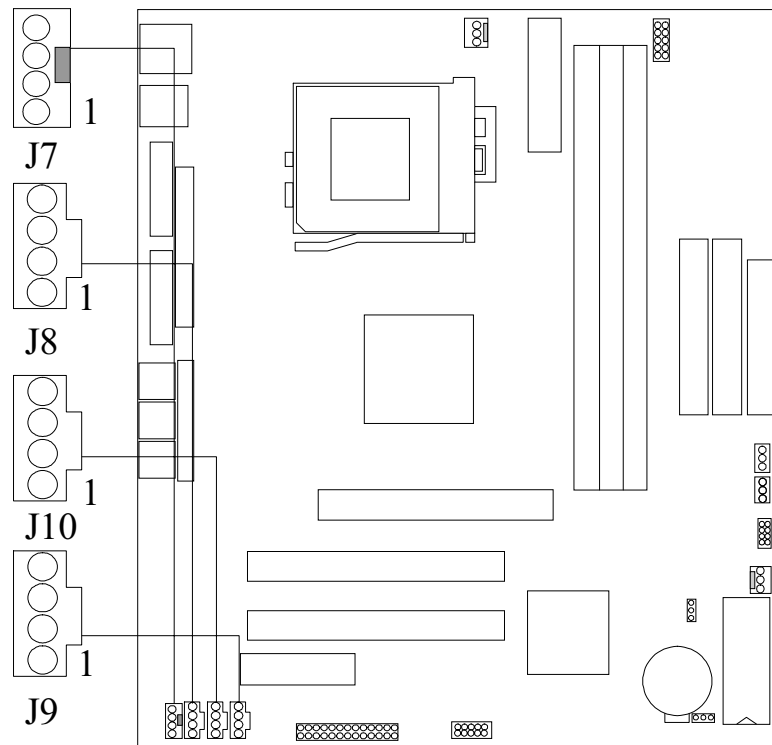

NOTES: After version 1.0, the ATX POWER (POWER1) will be removed just beside the KB/MS (CN1) & USB (USB1) port. (in vertical position)

1.9.1 CD Audio-In Connectors: J7/J8

Pin No. of J7	Assignment
1	Left Channel Input
2	CD_GND
3	Right Channel Input
4	CD_GND

Pin No. of J8	Assignment
1	Left Channel Input
2	CD_GND
3	CD_GND
4	Right Channel Input

1.9.2 Telephony Connector: J9

Pin No. of J9	Assignment
1	MONO_Out
2	CD_GND
3	CD_GND
4	PHONE

1.9.3 AUX Audio in Connector: J10 (Optional)

Pin No. of J10	Assignment
1	Left channel AUX_IN
2	CD_GND
3	CD_GND
4	Right channel AUX_IN

2. BIOS Setup

Introduction

This manual discussed Award™ Setup program built into the ROM BIOS. The Setup program allows users to modify the basic system configuration. This special information is then store in battery-backed RAM so that it retains the Setup information when the power is turned off.

The Award BIOS™ installed in your computer system's ROM (Read Only Memory) is a custom version of an industry standard BIOS. This means that it supports Intel processors in a standard IBM-AT compatible input/output system. The BIOS provides critical low-level support for standard devices such as disk drives and serial and parallel ports.

Adding important has customized the Award BIOS™, but nonstandard, features such as virus and password protection as well as special support for detailed fine-tuning of the chipset controlling the entire system.

The rest of this manual is intended to guide you through the process of configuring your system using Setup.

Plug and Play Support

These AWARD BIOS supports the Plug and Play Version 1.0A specification. ESCD (Extended System Configuration Data) write is supported.

EPA Green PC Support

This AWARD BIOS supports Version 1.03 of the EPA Green PC specification.

APM Support

These AWARD BIOS supports Version 1.1&1.2 of the Advanced Power Management (APM) specification. Power management features are implemented via the System Management Interrupt (SMI). Sleep and Suspend power management modes are supported. Power to the hard disk drives and video monitors can be managed by this AWARD BIOS.

PCI Bus Support

This AWARD BIOS also supports Version 2.1 of the Intel PCI (Peripheral Component Interconnect) local bus specification. Please see the Intel technical documentation for additional information.

DRAM Support

SDRAM (Synchronous DRAM) are supported.

Supported CPUs

This AWARD BIOS supports a single Intel CPU.

Using Setup

In general, you use the arrow keys to highlight items, press <Enter> to select, use the PageUp and PageDown keys to change entries, press <F1> for help and press <Esc> to quit. The following table provides more detail about how to navigate in the Setup program using the keyboard.

Keystroke	Function
Up arrow	Move to previous item
Down arrow	Move to next item
Left arrow	Move to the item on the left (menu bar)
Right arrow	Move to the item on the right (menu bar)
Esc	Main Menu: Quit without saving changes Submenus: Exit Current page to the next higher level menu
Move Enter	Move to the item you desired
PgUp key	Increase the numeric value or make changes
PgDn key	Decrease the numeric value or make changes
+ Key	Increase the numeric value or make changes
- Key	Decrease the numeric value or make changes
Esc key	Main Menu – Quit and not save changes into CMOS Status Page Setup Menu and Option Page Setup Menu – Exit Current page and return to Main Menu
F1 key	General help on Setup navigation keys
F5 key	Load previous values from CMOS
F6 key	Load the fail-safe defaults from BIOS default table
F7 key	Load the optimized defaults
F10 key	Save all the CMOS changes and exit

2.1 Main Menu

Once you enter Award BIOS™ CMOS Setup Utility, the Main Menu will appear on the screen. The Main Menu allows you to select from several setup functions and two exit choices. Use the arrow keys to select among the items and press <Enter> to accept and enter the sub-menu.

!! WARNING !!

The information about BIOS defaults on manual (**Figure 1,2,3,4,5,6,7,8**) is just for reference, please refer to the BIOS installed on board, for update information.

■ **Figure 1. Main Menu**

CMOS Setup Utility-Copyright (C) 1984-2000 Award Software

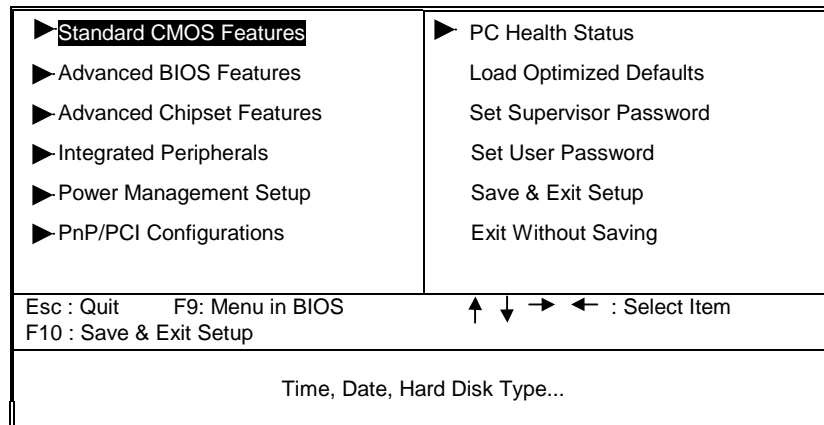

Standard CMOS Features

This setup page includes all the items in a standard compatible BIOS.

Advanced BIOS Features

This setup page includes all the items of BIOS special enhanced features.

Advanced Chipset Features

This setup page includes all the items of chipset special features.

Integrated Peripherals

This section page includes all the items of IDE hard drive and Programmed Input/Output features.

Power Management Setup

This setup page includes all the items of power management features.

PnP/PCI Configurations

This setup page includes IRQ Setting by user define or default.

PC Health Status

This setup page is the System auto detect Temperature, voltage, fan speed.

Load Optimized Defaults

These settings are more likely to configure a workable computer when something is wrong. If you cannot boot the computer successfully, select the BIOS Setup options and try to diagnose the problem after the computer boots. These settings do not provide optimal performance.

Set Supervisor Password

Change, set, or disable password. It allows you to limit access to the system and Setup, or just to Setup.

Set User Password

You can specify both a User and a Supervisor password. When you select either password option, you are prompted for a 1-6-character password. Enter the password and then retype the password when prompted.

Save & Exit Setup

Save CMOS value changes to CMOS and exit setup.

Exit Without Saving

Abandon all CMOS value changes and exit setup.

2.2 Standard CMOS Features

The items in Standard CMOS Setup Menu are divided into 10 categories. Each category includes no, one or more than one setup items. Use the arrow keys to highlight the item and then use the <PgUp> or <PgDn> keys to select the value you want in each item.

■ Figure 2. Standard CMOS Setup

CMOS Setup Utility-Copyright (C) 1984-2000 Award Software
Standard CMOS Features

Date (mm:dd:yy)	Thu, Jan 6 2000	Item Help
Time (hh:mm:ss)	11 : 37 : 30	Menu Level ▶
▶ IDE Primary Master	Press Enter None	
▶ IDE Primary Slave	Press Enter None	
▶ IDE Secondary Master	Press Enter None	Change the day, month, year and century
▶ IDE Secondary Slave	Press Enter None	
Drive A	1.44M, 3.5 in.	
Drive B	None	
Video	EGA/VGA	
Halt On	All, But Keyboard	
Base Memory	XXXX	
Extended Memory	XXXX	
Total Memory	XXXX	

↑ ↓ → ← : Move Enter :Select +/-/PU/PD :Value F10 :Save ESC :Exit F1 :General Help
F5 :Previous Values F6 :Fail-Safe Defaults F7 : Optimized Defaults

Main Menu Selections

This table shows the selections that you can make on the Main Menu.

Item	Options	Description
Date	MoM DD YYYY	Set the system date. Note That the 'Day' automatically changes when you set the date.
IDE Primary Master	Options are in its sub menu.	Press <Enter> to enter the sub menu of detailed options
IDE Primary Slave	Options are in its sub menu.	Press <Enter> to enter the sub menu of detailed options.
IDE Secondary Master	Options are in its sub menu.	Press <Enter> to enter the sub menu of detailed options.
IDE Secondary Slave	Options are in its sub menu.	Press <Enter> to enter the sub menu of detailed options.
Drive A Drive B	None 360K, 5.25 in 1.2M, 5.25 in 720K, 3.5 in 1.44M, 3.5 in 2.88M, 3.5 in	Select the type of floppy disk drive installed in your system.
Video	EGA/VGA CGA 40 CGA 80 MONO	Select the default video device.

Item	Options	Description
Halt On	All Errors No Errors All, but Keyboard All, but Diskette All, but Disk/Key	Select the situation in which you want the BIOS to stop the POST process and notify you.
Base Memory	N/A	Displays the amount of conventional memory detected during boot up.
Extended Memory	N/A	Displays the amount of extended memory detected during boot up.
Total Memory	N/A	Display the total memory available in the system.

2.3 Advanced BIOS Features

■ Figure 3. Advanced BIOS Setup

CMOS Setup Utility-Copyright (C) 1984-2000 Award Software
Advanced BIOS Features

Virus Warning	Disabled		Item Help
CPU Internal Cache	Enabled		Menu Level ▶
External Cache	Enabled		<p>Allows you to choose the VIRUS warning feature for IDE Hard disk boot sector protection. If this function is enabled and someone attempt to write data into this area, BIOS will show a warning message on screen and alarm beep</p>
CPU L2 Cache ECC Checking	Enabled		
Processor Number Feature	Disabled		
Quick Power On Self Test	Enabled		
First Boot Device	Floppy		
Second Boot Device	HDD-0		
Third Boot Device	CDROM		
Boot Other Device	Enabled		
Swap Floppy Drive	Disabled		
Boot Up Numlock Status	On		
Gate A20 Option	Fast		
Security Option	Setup		
OS Select For DRAM > 64 MB	Non-OS2		
Report No FDD For WIN 98	No		
Video BIOS Shadow	Enabled		
C8000-CBFFF Shadow	Disabled		
CC000-CFFFF Shadow	Disabled		
D0000-D3FFF Shadow	Disabled		
D4000-D7FFF Shadow	Disabled		
D8000-DBFFF Shadow	Disabled		
DC000-DFFFF Shadow	Disabled		

↑ ↓ → ← : Move Enter :Select +/-/PU/PD :Value F10 :Save ESC :Exit F1 :General Help
 F5 :Previous Values F6 :Fail-Safe Defaults F7 : Optimized Defaults

Virus Warning

Allows you to choose the VIRUS Warning feature for IDE Hard Disk boot sector protection. If this function is enabled and someone attempts to write data into this area, BIOS will show a warning message on screen and alarm beep.

Disabled (default)	No warning message appears when anything attempts to access the boot sector or hard disk partition table.
Enabled	Activates automatically when the system boots up causing a warning message to appear when anything attempts to access the boot sector of hard disk partition table.

CPU Internal Cache

These two categories speed up memory access. However, it depends on CPU/chipset design.

Enabled (default)	Enable cache
Disabled	Disable cache

External Cache

These fields allow you to Enable or Disable the CPU's "Level 2" secondary cache. Caching allows better performance.

Enabled (default)	Enable cache
Disabled	Disable cache

CPU L2 Cache ECC Checking

This item allows you to enable/disable CPU L2 Cache ECC checking.

The Choices: **Enabled** (default), Disabled.

Processor Number Feature

The VIA processor serial number control option.

The Choices: **Disabled** (default), Enabled.

Quick Power On Self Test

This category speeds up Power on Self-Test (POST) after you power up the computer. If it is set to Enable, BIOS will shorten or skip some check items during POST.

Enabled (default)	Enable quick POST
Disabled	Normal POST

First /Second/Third/Other Boot Device

These BIOS attempts to load the operating system from the devices in the sequence selected in these items.

The Choices: Floppy, LS/ZIP, HDD-0, SCSI, HDD-1, HDD-2, HDD-3, LAN, Disabled, CDROM, Enabled.

Swap Floppy Drive

If the system has two floppy drives, you can swap the logical drive name assignments.

The Choices: Enabled, **Disabled** (default).

Boot Up NumLock Status

Select power on state for NumLock.

On (default)	Numpad is number keys.
Off	Numpad is arrow keys.

Gate A20 Option

Select if chipset or keyboard controller should control GateA20.

Normal	A pin in the keyboard controller controls GateA20.
Fast (default)	Lets chipset control GateA20.

Security Option

Select whether the password is required every time the system boots or only when you enter setup.

System	The system will not boot and access to Setup will be denied if the correct password is not entered at the prompt.
Setup (default)	The system will boot, but access to Setup will be denied if the correct password is not entered at the prompt.

*Note: To disable security, select **PASSWORD SETTING** at Main Menu and then you will be asked to enter password. Do not type anything and just press <Enter>, it will disable security. Once the security is disabled, the system will boot and you can enter Setup freely.*

OS Selection for DRAM > 64MB

Select the operating system that is running with greater than 64MB of RAM on the system.

The Choices: Non-OS2 (default), OS2.

Report No FDD For WIN 98

Whether report no FDD for Win 98 or not.

The Choices: Yes, No (default).

Video BIOS Shadow

Determines whether video BIOS will be copied to RAM for faster execution.

Enabled (default)	Optional ROM is enabled.
Disabled	Optional ROM is disabled.

C8000 - CFFFF Shadow / D0000 - DFFFF Shadow

Determines whether the optional ROM will be copied to RAM for faster execution.

Enabled	Optional ROM is shadowed.
Disabled (default)	Optional ROM is not shadowed.

Note : For C8000 - DFFFF option - ROM on PCI BIOS, BIOS will automatically enable the shadow RAM. User does not have to select the item.

2.4 Advanced Chipset Features

This section allows you to configure the system based on the specific features of the installed chipset. This chipset manages bus speeds and access to system memory resources, such as DRAM and the external cache. It also coordinates communications between the conventional PCI bus. It must be stated that these items should never need to be altered. The default settings have been chosen because they provide the best operating conditions for your system. The only time you might consider making any changes would be if you discovered that data was being lost while using your system.

■ Figure 4. Advanced Chipset Setup

CMOS Setup Utility-Copyright (C) 1984-2000 Award Software
Advanced Chipset Features

DRAM Clock	Auto	Item Help
AGP Aperture Size	64M	
AGP-4X Mode	Enabled	Menu Level ►
AGP Driving Control	Auto	
X AGP Driving Value	DA	
Onboard Sound	Enabled	
OnChip Modem	Auto	
Memory Parity /ECC Check	Disabled	

↑ ↓ → ← : Move Enter :Select +/-/PU/PD :Value F10 :Save ESC :Exit F1 :General Help
 F5 :Previous Values F6 :Fail-Safe Defaults F7 : Optimized Defaults

DRAM Clock

When synchronous DRAM is installed, the number of clock cycles of CAS latency depends on the DRAM timing.

The Choices:Auto (default),Host CLK,HCLK-33M,HCLK+33M.

AGP Aperture Size

This field lets you insert a timing delay between the CAS and RAS strobe signals, used when DRAM is written to, read from, or refreshed. *Fast* gives faster performance; and *Slow* gives more stable performance. This field applies only when synchronous DRAM is installed in the system.

The Choices: 64M (default), 32M, 16M, 8M, 4M, 128M.

AGP-4X Mode

If an insufficient number of cycles is allowed for RAS to accumulate its charge before DRAM refresh, the refresh may be incomplete and the DRAM may fail to retain data. *Fast* gives faster performance; and *Slow* gives more stable performance. This field applies only when synchronous DRAM is installed in the system.

The Choices: Enabled (default), Disabled.

AGP Driving Control

The option determine the AGP Output Buffer Drive Strength.

The Choices: Auto (default), Manual.

AGP Driving Value

The option determine the AGP Output Buffer Drive Strength.

The Choice: DA (default).

Onboard Sound

Selecting Enabled allows caching of the system BIOS ROM at F0000h-FFFFFh, resulting in better system performance. However, if any program writes to this memory area, a system error may result.

The Choices: Enabled (default), Disabled.

OnChip Modem

Select Enabled allows caching of the video BIOS, resulting in better system performance. However, if any program writes to this memory area, a system error may result.

The Choices: Auto (default), Disabled.

Memory Parity/ECC Check

You can reserve this area of system memory for ISA adapter ROM. When this area is reserved, it cannot be cached. The user information of peripherals that need to use this area of system memory usually discusses their memory requirements.

The Choices: Disabled (default), Enabled.

2.5 Integrated Peripherals

■ Figure 5. Integrated Peripherals

CMOS Setup Utility-Copyright (C) 1984-2000 Award Software
Integrated Peripherals

On-Chip IDE Channel 0	Enabled		Item Help
On-Chip IDE Channel 1	Enabled		
IDE Prefetch Mode	Enabled		Menu Level ▶
Primary Master	PIO	Auto	
Primary Slave	PIO	Auto	
Secondary Master	PIO	Auto	
Secondary Slave	PIO	Auto	
Primary Master	UDMA	Auto	
Primary Slave	UDMA	Auto	
Secondary Master	UDMA	Auto	
Secondary Slave	UDMA	Auto	
Init Display First		PCI Slot	
USB Keyboard Support		Disabled	
IDE HDD Block Mode		Enabled	
Onboard FDD Controller		Enabled	
Onboard Serial Port 1		3F8/IRQ4	
Onboard Serial Port 2		2F8/IRQ3	
UART 2 Mode		Standard	
X IR Function Duplex		Half	
X TX,RX inverting enable		LO,LO	
Onboard Parallel Port		378/IRQ7	
Onboard Parallel Mode		Normal	
X ECP Mode Use DMA		3	
Parallel Port EPP Type		EPP1.9	
Onboard Legacy Audio		Enabled	
Sound Blaster		Disabled	
SB I/O Base Address		220H	
SB IRQ Select		IRQ 5	
SB DMA Select		DMA 1	
MPU-401		Disabled	
MPU-401 I/O Address		330-333H	
Game Port (200-207H)		Enabled	

↑ ↓ → ← : Move Enter :Select +/-/PU/PD :Value F10 :Save ESC :Exit F1 :General Help
 F5 :Previous Values F6 :Fail-Safe Defaults F7 : Optimized Defaults

On-Chip IDE Channel 0

The integrated peripheral controller contains an IDE interface with support for two IDE channels. Select Enabled to activate each channel separately.

The Choices: Enabled (default), Disabled

On-Chip IDE Channel 1

The integrated peripheral controller contains an IDE interface with support for two IDE channels. Select Enabled to activate each channel separately.

The Choices: Enabled (default), Disabled

Primary / Secondary Master / Slave PIO

The IDE PIO (Programmed Input / Output) fields let you set a PIO mode (0-4) for each of the IDE devices that the onboard IDE interface supports. Modes 0 through 4 provide successively increased performance. In Auto mode, the system automatically determines the best mode for each device.

The Choices: Auto (default), Mode0, Mode1, Mode2, Mode3, Mode4.

Primary / Secondary Master / Slave UDMA

Ultra DMA /33 implementation is possible only if your IDE hard drive supports it and the operating environment includes a DMA drive (Windows 95 OSR2 or a third party IDE bus master driver). If your hard drive and your system software both support Ultra DMA/33, select Auto to enable BIOS support.

The Choices: Auto (default), Disabled.

Init Display First

This item allows you decide to active whether PCI Slot or on-chip VGA first.

The Choices: PCI Slot (default), AGP.

USB Keyboard Support

USB keyboard support in DOS mode .

Enabled	Enable USB Keyboard Support.
Disabled (default)	Disable USB Keyboard Support.

IDE HDD Block Mode

Block mode is also called block transfer, multiple commands, or multiple sector read/write. If your IDE hard drive supports block mode (most new drives do), select Enabled for automatic detection of the optimal number of block mode (most new drives do), select Enabled for automatic detection of the optimal number of block read/writes per sector the drive can support.

The Choices: Enabled (default), Disabled.

Onboard FDD Controller

Select Enabled if your system has a floppy disk controller (FDD) installed on the system board and you wish to use it. If install and FDD or the system has no floppy drive, select Disabled in this field.

The Choices: Enabled (default), Disabled.

Onboard Serial Port 1/Port 2

Select an address and corresponding interrupt for the first and second serial ports.

The Choices: (3F8/IRQ4), (2F8/IRQ3), (3E8/ IRQ4), (2E8 / IRQ3) , Auto, Disabled.

UART 2 Mode

This item allows you to determine which Infra Red (IR) function of onboard I/O chip.

The Choices: Standard (default), HPSIR,ASKIR.

IR Function Duplex

This item allows you to decide to active IR transmission delay.

The Choice: Half (default).

Tx, Rx inverting enable

This item allows you to determine the active of Rx, Tx.

The Choice: Lo,Lo (default) .

Onboard Parallel Port

This item allows you to determine access onboard parallel port controller with which I/O Address.

The Choices: 378/IRQ7 (default), 278/IRQ5, Disabled, 3BC/IRQ7.

Parallel Port Mode

Select an operating mode for the onboard parallel (printer) port. Normal EPP (Extend Parallel Port) ECP (Extend Capabilities Port) ECP +EPP PC AT parallel port Bidirectional Port Fast, buffered port Fast, buffered, Bidirectional Port. Select Normal unless you are certain your hardware and software both support EPP or ECP mode.

The Choices: Normal (default), ECP,ECP/EPP,EPP.

ECP Mode Use DMA

Select a DMA Channel for the port.

The Choice: 3 (default).

Parallel Port EPP type

Select a DMA Channel for the port.

The Choices: EPP1.9 (default),EPP1.7.

Onboard Legacy Audio

Select an operating mode for the second serial port:

The choices: Enabled (default) , Disabled.

Sound Blaster

Hardware SoundBlaster Pro for Windows DOS box and real-mode DOS legacy compatibility.

SB I/O Base Address

Change the SoundBlaster Pro Base I/O Address settings.

SB IRQ Select

Change the SoundBlaster Pro interrupt signal.

SB DMA Select

Change the SoundBlaster Pro direct memory access setting.

MPU-401

Enable or Disable MPU-401 option.

MPU-401 I/O Address

Change the SoundBlaster Pro MPU-401 I/O address.

Game Port (200-207H)

Change the joystick connect port address.

2.6 Power Management Setup

The Power Management Setup allows you to configure you system to most effectively save energy while operating in a manner consistent with your own style of computer use.

■ Figure 6. Power Management Setup

CMOS Setup Utility-Copyright (C) 1984-2000 Award Software
Power Management Setup

ACPI Suspend Type	S1 (POS)	Item Help
Power Management	User Define	
Video Off Option	Suspend -> Off	Menu Level ▶
Video Off Method	V/H SYNC+Blank	
MODEM Use IRQ	3	
Soft-Off by PWRBTN	Instant-Off	
HDD Power Down	Disabled	
Doze Mode	Disabled	
Suspend Mode	Disabled	
Wake Up On LAN/Ring	Disabled	
RTC Alarm Resume	Disabled	
X Date (of Month)	0	
X Resume Time (hh:mm:ss)	0	
X Resume Time (hh:mm:ss)	0	
X Resume Time (hh:mm:ss)	0	

↑ ↓ → ← : Move Enter : Select +/-/PU/PD : Value F10 : Save ESC : Exit F1 : General Help
 F5 : Previous Values F6 : Fail-Safe Defaults F7 : Optimized Defaults

ACPI Suspend Type

The item allows you to select the suspend type under ACPI operating system.

S1 (POS) (default)	Power on Suspend
S3 (STR)	Suspend to RAM

Power Management

This category allows you to select the type (or degree) of power saving and is directly related to the following modes:

1. HDD Power Down.
2. Doze Mode.
3. Suspend Mode.

There are four selections for Power Management, three of which have fixed mode settings

MinSaving	Minimum power management. Doze Mode = 1 hr. Standby Mode = 1 hr., Suspend Mode = 1 hr., and HDD Power Down = 15 min.
MaxSaving	Maximum power management—ONLY AVAILABLE FOR SL CPU's. Doze Mode = 1 min., Standby Mode = 1 min., Suspend Mode = 1 min., and HDD Power Down = 1 min.
User Define (default)	Allows you to set each mode individually. When not disabled, each of the ranges are from 1 min. to 1 hr. except for HDD Power Down which ranges from 1 min. to 15 min. and disable.

Video Off Option

This determines the manner in which the monitor is blanked.

Suspend —> Off (default)	During Suspend mode, the monitor will be turned off.
All Modes —> Off	During All modes, the monitor will be turned off.
Always On	During Always mode, the monitor will be

turned on.

Video Off Method

This determines the manner in which the monitor is blanked.

V/H SYNC+Blank (default) This selection will cause the system to turn off the vertical and horizontal synchronization ports and write blanks to the video buffer.

DPMS Support Initial display power management signaling.

Blank Screen This option only writes blanks to the video buffer.

MODEM Use IRQ

This determines the IRQ in which the MODEM can use.

The Choices: 3 (default), 4, 5, 7, 9, 10, 11, NA.

Soft-Off by PWRBTN

Pressing the power button for more than 4 seconds forces the system to enter the Soft-Off state when the system has "hung".

The Choices: Delay 4 Sec, **Instant-Off** (default).

HDD Power Down

When enabled and after the set time of system inactivity, the hard disk drive will be powered down while all other devices remain active.

Disable (default)

1Min, 2Min, 3Min, 4Min, 5Min, 6Min, 7Min, 8Min, 9Min, 10Min, 11Min, 12Min, 13Min, 14Min, 15Min.

Doze Mode / Suspend Mode

The **Doze Mode**, and **Suspend Mode** fields set the Period of time after which each of these modes activate. At *Max Saving*, these modes activate sequentially (in the given order) after one minute; at *Min Saving* after one hour.

Disable (default)

1Min, 2Min, 4Min, 6Min, 8Min, 10Min, 20Min, 30Min, 40Min, 1hour.

Wake Up On LAN/Ring

When you select Enabled, a PME signal from PCI card returns the system to Full On state.

The Choices: Enabled, Disabled (default).

RTC Alarm Resume

When Enabled, you can set the date and time at which the RTC (real-time clock) alarm awakens the system from Suspend mode.

Disabled (default).

Date (of Month) /Time (hh:mm:ss)

You could set the date (of month) and timer (hh:mm:ss),any event occurring at will awaken a system witch has been powered down.

2.7 PnP/PCI Configurations

This section describes configuring the PCI bus system. PCI, or Personal Computer Interconnect, is a system which allows I/O devices to operate at speeds nearing the speed the CPU itself uses when communicating with its own special components. This section covers some very technical items and it is strongly recommended that only experienced users should make any changes to the default settings.

■ Figure 7. PnP/PCI Configurations

CMOS Setup Utility-Copyright (C) 1984-2000 Award Software
PnP/PCI Configurations

PNP OS Installed	NO	Item Help
Reset Configuration Data	Disabled	
Resources Controlled By	Auto (ESCD)	Menu Level ▶
X IRQ Resources	Press Enter	
X DMA Resources	Press Enter	
PCI/VGA Palette Snoop	Disabled	
Assign IRQ For VGA	Enabled	
Assign IRQ For USB	Enabled	
		Select Yes if you are using a Plug and Play capable operating system Select NO if you need the BIOS to configure non-boot devices

↑ ↓ → ← : Move Enter :Select +/-/PU/PD :Value F10 :Save ESC :Exit F1 :General Help
F5 :Previous Values F6 :Fail-Safe Defaults F7 : Optimized Defaults

PNP OS Installed

When set to YES, BIOS will only initialize the PnP cards used for booting (VGA, IDE, SCSI). The rest of the cards will be initialized by the PnP operating systems, like WindowsTM95. When set to NO, BIOS will initialize all the PnP cards. Therefore for non-PnP operating system (DOS, NetwareTM), this option must set to “NO”.

Reset Configuration Data

The system BIOS supports the PnP feature so the system needs to record which resource is assigned and proceeds resources from conflict. Every peripheral device has a node, which is called ESCD. This node records which resources are assigned to it. The system needs to record and update ESCD to the memory locations. These locations (4K) are reserved at the system BIOS.

If Disabled (default) is chosen, the system's ESCD will update only when the new configuration varies from the last one.

If Enabled is chosen, the system is forced to update ESCDs and then is automatically set to the “Disabled” mode.

IRQ-3	assigned to : PCI / ISA PnP
IRQ-4	assigned to : PCI / ISA PnP
IRQ-5	assigned to : PCI / ISA PnP
IRQ-7	assigned to : PCI / ISA PnP
IRQ-9	assigned to : PCI / ISA PnP
IRQ-10	assigned to : PCI / ISA PnP
IRQ-11	assigned to : PCI / ISA PnP
IRQ-12	assigned to : PCI / ISA PnP
IRQ-14	assigned to : PCI / ISA PnP
IRQ-15	assigned to : PCI / ISA PnP
DMA-0	assigned to : PCI / ISA PnP
DMA-1	assigned to : PCI / ISA PnP
DMA-3	assigned to : PCI / ISA PnP
DMA-5	assigned to : PCI / ISA PnP
DMA-6	assigned to : PCI / ISA PnP
DMA-7	assigned to : PCI / ISA PnP

The above settings will be shown on the screen only if “Manual” is chosen for the Resources Controlled By function.

Legacy is the term, which signifies that a resource is assigned to the ISA Bus and provides for non-PnP ISA add-on cards. PCI / ISA PnP signifies that a resource is assigned to the PCI Bus or provides for ISA PnP add-on cards and peripherals.

The Choices: Disabled (default), Enabled.

Resources Controlled By

By Choosing “Auto” the system BIOS will detect the system resources and automatically assign the relative IRQ and DMA channel for each peripheral.

By Choosing “Manual”, the user will need to assign IRQ & DMA for add-on cards. Be sure that there are no IRQ/DMA and I/O port conflicts.

The Choices: Auto (ESCD) (default), Manual.

IRQ Resources

When resources are controlled manually, assign each system interrupt a type, depending on the type of device using the interrupt.

DMA Resources

When resources are controlled manually, assign each system DMA channel a type, depending on the type of device using the DMA channel.

PCI / VGA Palette Snoop

Choose Disabled or Enabled. Some graphic controllers which are not VGA compatible take the output from a VGA controller and map it to their display as a way to provide boot information and VGA compatibility.

However, the color information coming from the VGA controller is drawn from the palette table inside the VGA controller to generate the proper colors, and the graphic controller needs to know what is in the palette of the VGA controller. To do this, the non-VGA graphic controller watches for the Write access to the VGA palette and registers the snoop data. In PCI based systems, where the

VGA controller is on the PCI bus and a non-VGA graphic controller is on an ISA bus, the Write Access to the palette will not show up on the ISA bus if the PCI VGA controller responds to the Write.

In this case, the PCI VGA controller should not respond to the Write, it should only snoop the data and permit the access to be forwarded to the ISA bus. The non-VGA ISA graphic controller can then snoop the data on the ISA bus. Unless you have the above situation, you should disable this option.

Disabled (default)	Disables the function.
Enabled	Enables the function.

Assign IRQ For USB

Lets the user choose which IRQ to assign for USB.

The Choices: Enabled (default),Disabled.

Assign IRQ For VGA

Lets the user choose which IRQ to assign for the VGA.

The Choices: Enabled (default),Disabled.

2.8 PC Health Status

■ Figure 8. Frequency/Voltage Control

CMOS Setup Utility-Copyright (C) 1984-2000 Award Software
PC Health Status

Show H/W Monitor in POST	3sec		Item Help
Current CPU FAN Speed		RPM	Menu Level
Current System FAN Speed		RPM	
Vcore	V		
+2.5V	V		
+3.3V	V		
+5.0V	V		
+12.0V	V		

↑ ↓ → ← : Move Enter :Select +/-/PU/PD :Value F10 :Save ESC :Exit F1 :General Help
 F5 :Previous Values F6 :Fail-Safe Defaults F7 : Optimized Defaults

Show H/W Monitor in Post

If your computer contains a monitoring system, it will show PC health status during POST stage. The item offers several delay times to select the one you want.
3 sec (default).

Current CPU FAN Speed

These fields display the current speed of up to CPU and System fans, if your computer contains a monitoring system.

Current System FAN Speed

These fields display the current speed of up to CPU and System fans, if your computer contains a monitoring system.

2.9 Load Optimized Defaults

When you press <Enter> on this item you get a confirmation dialog box with a message similar to:

■ Figure 9. Load Optimized Defaults

CMOS Setup Utility-Copyright (C) 1984-2000 Award Software

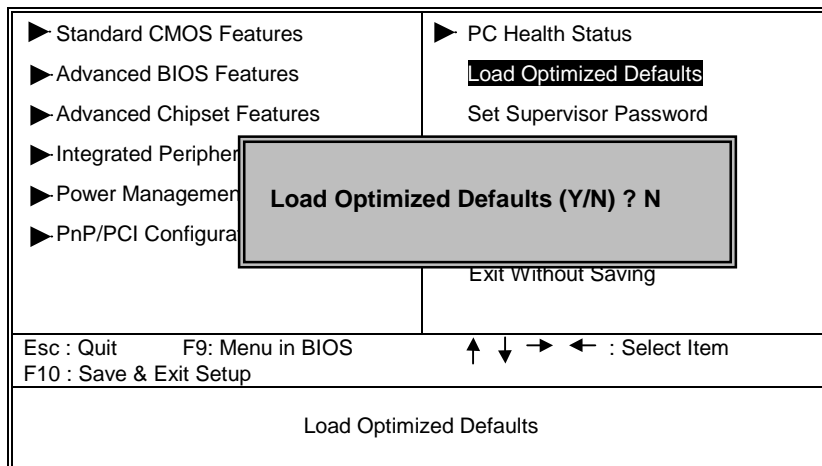

Pressing 'Y' loads the BIOS default values for the most stable, minimal-performance system operations.

2.10 Set Supervisor/User Password

■ Figure 10. Set Supervisor/User Password

CMOS Setup Utility-Copyright (C) 1984-2000 Award Software

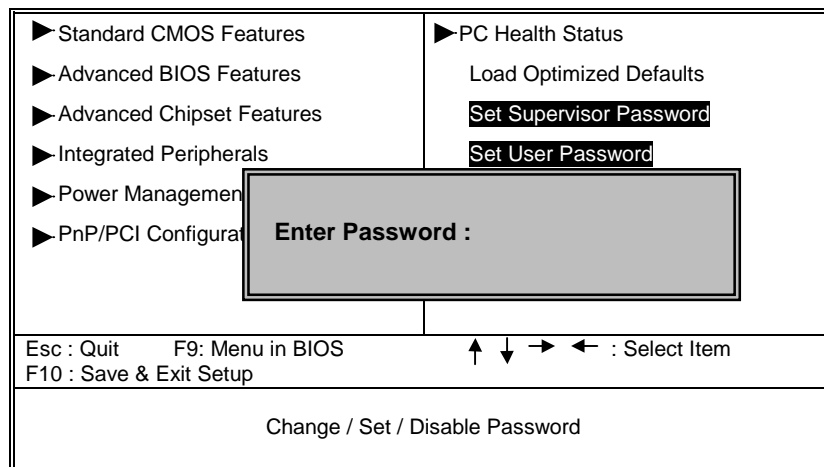

When you select this function, the following message will appear at the center of the screen to assist you in creating a password.

ENTER PASSWORD

Type the password, up to eight characters, and press <Enter>. The password you type now will clear any previously entered password from CMOS memory. You will be asked to confirm the password. Type the password again and press <Enter>. You may also press <ESC> to abort the selection and not enter a password. To disable password, just press <Enter> when you are prompted to enter password. A message will confirm that you wish to disable the password. Once the password is disabled, the system will boot and you can enter setup freely.

PASSWORD DISABLED

If you select “System” at the Security Option of BIOS Features Setup Menu, you will be prompted for the password every time the system is rebooted or any time you try to enter Setup. If you select “Setup” at Security Option of BIOS Feature Setup Menu, you will be prompted only when you try to enter Setup.

2.11 Save & Exit Setup

■ Figure 11. Save & Exit Setup

CMOS Setup Utility-Copyright (C) 1984-2000 Award Software

▶ Standard CMOS Features	▶ PC Health Status
▶ Advanced BIOS Features	Load Optimized Defaults
▶ Advanced Chipset Features	Set Supervisor Password
▶ Integrated Periph	
▶ Power Manage	
▶ PnP/PCI Config	

SAVE to CMOS and Exit (Y/N) ? Y

Esc : Quit	F9: Menu in BIOS	↑ ↓ → ← : Select Item
F10 : Save & Exit Setup		

Save Data to CMOS

Type "Y" will quit the Setup Utility and save the user setup value to RTC CMOS RAM.

Type "N" will return to Setup Utility.

2.12 Exit Without Saving

■ Figure 12. Exit Without Saving

CMOS Setup Utility-Copyright (C) 1984-2000 Award Software

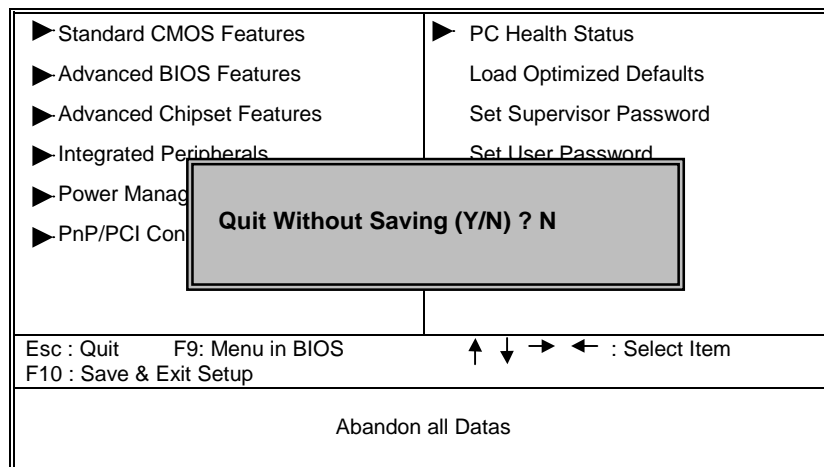

Type "Y" will quit the Setup Utility without saving to RTC CMOS RAM.
Type "N" will return to Setup Utility.

3. Software Setup

NOTE: The mark * means it can be installed directly from CD by using CD Installation Utility (i.e. START.EXE).

3.1 Software List

Category	Description	Platform	Location in CD
VIA Service Pack (4 In1) *	VIA 4 IN 1 driver includes(VIA Registry (ACPI) Driver/VIA AGP VxD driver /VIA ATAPI Vendor Support Driver/VIA PCI IRQ Miniport Driver) four system drivers to improve the performance and maintain the stability of system using VIA chipset.	Windows 95/98/NT 4.0	\\Mb_drv\Service
VIA Hardware Monitor *	VIA Hardware Monitor is a self-diagnostic system for PC.	Windows 95/98	\\Mb_drv\Sysdiag
HighPoint XStore Pro *	Install the drivers to support Ultra DMA mode Hard Drive.	Windows 95/98	\\Mb_drv\XStore
VIA AC97 Audio*	Install the driver to enable the VIA AC97 Audio Device	DOS, Windows 95/98/NT4.0/ WIN2000	\\Audio\VIA
Aurel Votex Au8810 Audio*	Install the driver to enable the Aurel Audio device	WIN9X/NT4.0 WIN2000	\\Audio\Aurel
Creative SB PCI128 Audio*	Install the driver to enable the Creative Audio Device	WIN9X/NT4.0 WIN2000	\\Audio\Creative
Award Flash Utility	Used for updating BIOS.		\\Flash

3.2 Software Installation

We provide an installation wizard, Driver CD Installation Utility (START.EXE), located in the root of Driver CD to let users install some common used drivers conveniently.

➤ **The drivers can be installed from CD by using CD Installation Utility:**

You can simply put Driver CD into CD-ROM drive and the Installation Utility will autorun or you can run the Driver CD Installation Utility directly by using mouse cursor to click the proper option on the page. Utility will invoke other applications to complete the rest of installation.

➤ **The drivers CAN NOT be installed directly from CD by using CD Installation Utility:**

Please read the README.TXT located in the root directory on Multimedia CD to get drivers' location and then refer to the INSTALL.TXT or README.TXT files located in each driver directory on the Driver CD to install drivers.

3.3 Using Software

- In general, you can get more detailed information in the on-line help or readme for the softwares.

- **Using VIA Hardware Monitor**

After the utility is installed, you can follow the sequence, **Start** → **Program** → **VIA Hardware Monitor System**, to launch the monitor application.

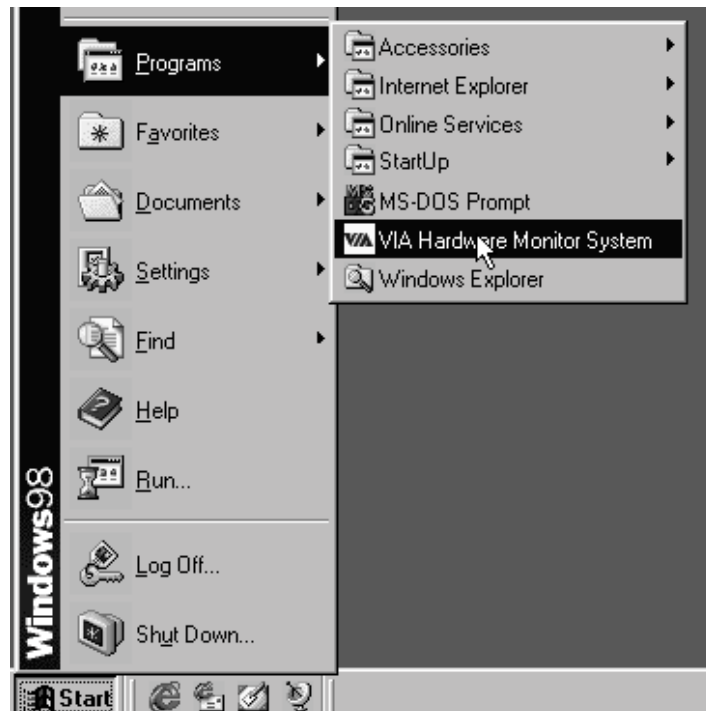

The following figure is the main panel of VIA Hardware Monitor. In the panel, you can get some real-time and important information -- Voltage, Fan speed, and temperature, for example. If there is an abnormal situation, you can resolve it immediately.

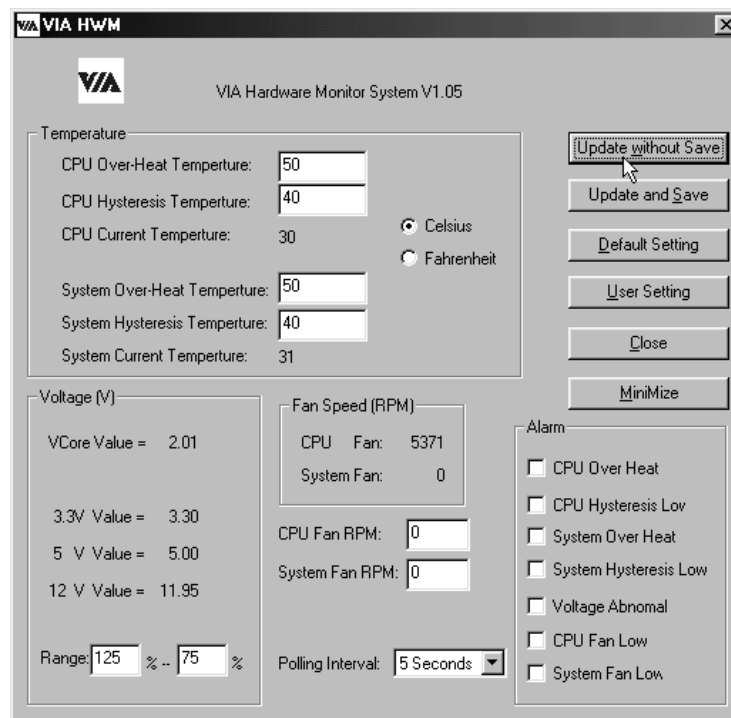

4. Trouble Shooting

PROBLEM

No power to the system at all. Power light does not illuminate, fan inside power supply does not turn on. Indicator light on keyboard does not turn on.

PROBABLE CAUSE	DIAGNOSIS	SOLUTION
Power cable is unplugged.	Visually inspect power cable	Make sure power cable is securely plugged in.
Defective power cable.	Visually inspect the cable, try another cable.	Replace cable.
Power supply failure.	Power cable and wall socket are OK, but system is still dead.	Contact technical support.
Faulty wall outlet; circuit Breaker or fuse blown.	Plug in device known to work in socket and test.	Use different socket, repair outlet, reset circuit breaker or replace fuse.

PROBLEM

System inoperative. Keyboard lights are on, power indicator lights are lit, hard drive is spinning.

PROBABLE CAUSE	DIAGNOSIS	SOLUTION
Memory DIMM is partially dislodged from the slot on the motherboard.	Turn off computer. Take cover off system unit. Check the DIMM to ensure it is securely seated in the slot.	Using even pressure on both ends of the DIMM, press down firmly until the module snaps into place.

PROBLEM

System does not boot from hard disk drive, can be booted from CD-ROM drive.

PROBABLE CAUSE	DIAGNOSIS	SOLUTION
Connector between hard drive and system board unplugged.	When attempting to run the FDISK utility you get a message, INVALID DRIVE SPECIFICATION.	Check cable running from disk to disk controller board. Make sure both ends are securely plugged in; check the drive type in the standard CMOS setup (see HARD DISK section of this manual).
Damaged hard disk or disk controller.	Format hard disk; if unable to do so the hard disk may be defective.	Contact technical support.
Hard disk directory or FAT is scrambled.	Run the FDISK program, format the hard drive (see HARD DRIVE section of manual). Copy data that was backed up onto hard drive.	Backing up the hard drive is extremely important. All hard disk are capable of breaking down at any time.

PROBLEM

System only boots from CD-ROM. Hard disk can be read and applications can be used but booting from hard disk is impossible.

PROBABLE CAUSE	DIAGNOSIS	SOLUTION
Hard disk boot program has been destroyed.	A number of causes could be behind this.	Back up data and applications files. Reformat the hard drive . Re-install applications and data using backup disks.

PROBLEM

Error message reading “SECTOR NOT FOUND” or other error messages not allowing certain data to be retrieved.

PROBABLE CAUSE	DIAGNOSIS	SOLUTION
A number of causes could be behind this.	Use a file by file backup instead of an image backup to backup the hard disk.	Back up any salvageable data. Then low level format, partition, and high level format the hard drive . Re-install all saved data when completed.

PROBLEM

Screen message says “Invalid Configuration” or “CMOS Failure.”

PROBABLE CAUSE	DIAGNOSIS	SOLUTION
Incorrect information entered into the configuration (setup) program.	Check the configuration program. Replace any incorrect information.	Review system’s equipment . Make sure correct information is in setup.

PROBLEM

Screen is blank.

PROBABLE CAUSE	DIAGNOSIS	SOLUTION
No power to monitor.		Check the power connectors to monitor and to system. Make sure monitor is connected to display card.
Monitor not connected to computer.		See instructions above.

PROBLEM

PROBABLE CAUSE	DIAGNOSIS	SOLUTION
Memory problem.		Reboot computer. Reinstall memory, make sure that all memory modules are installed in correct sockets.
Computer virus.		Use anti-virus programs to detect and clean viruses.

PROBLEM

Screen goes blank periodically.

PROBABLE CAUSE	DIAGNOSIS	SOLUTION
Screen saver is enabled.		Disable screen saver.

PROBLEM

Keyboard failure.

PROBABLE CAUSE	DIAGNOSIS	SOLUTION
Keyboard is disconnected.		Reconnect keyboard. Check keys again, if no improvement replace keyboard.

PROBLEM

No color on screen.

PROBABLE CAUSE	DIAGNOSIS	SOLUTION
Faulty Monitor.		If possible, connect monitor to another system. If no color replace monitor.
CMOS incorrectly set up.		Call technical support.

PROBLEM

C: drive failure.

PROBABLE CAUSE	DIAGNOSIS	SOLUTION
Hard drive cable not connected properly.		Check hard drive cable.

PROBLEM

Cannot boot system after installing second hard drive.

PROBABLE CAUSE	DIAGNOSIS	SOLUTION
Master/slave jumpers not set correctly.		Set master/slave jumpers correctly.
Hard drives not compatible / different manufacturers.		Run SETUP program and select correct drive types. Call drive manufacturers for compatibility with other drives.

PROBLEM

Missing operating system on hard drive.

PROBABLE CAUSE	DIAGNOSIS	SOLUTION
CMOS setup has been changed.		Run setup and select correct drive type.

PROBLEM

Certain keys do not function.

PROBABLE CAUSE	DIAGNOSIS	SOLUTION
Keys jammed or defective.		Replace keyboard.

PROBLEM

Keyboard is locked, no keys function.

PROBABLE CAUSE	DIAGNOSIS	SOLUTION
Keyboard is locked.		Unlock keyboard.

03/17/2000
MADE IN TAIWAN
R.O.C.