M6VSA

Federal Communications Commission (F.C.C) Statement

This device complies with Part 15 of the FCC Rules. Operation of this device is subject to the following two conditions: (1) this device may not cause harmful interference, and (2) this device must accept any interference received, including interference that may cause undesired operation.

Accessories: This device has been tested and found to comply with the limits of a Class B digital device, the accessories associated with this equipment are as follows:

1. Shielded serial cable. (Can be obtained from multiple retail outlets)
2. Shielded printer cable. (Can be obtained from multiple retail outlets)
3. Shielded video cable. (Can be obtained from multiple retail outlets)
4. Shielded power cord. (Provided by manufacturer)

These accessories are required to be used in order to ensure compliance with FCC Rules. It is the responsibility of the user to provide and use these accessories properly.

This equipment has been tested and found to comply with the limits of a Class B digital device, pursuant to Part 15 of the FCC Rules. These limits are designed to provide reasonable protection against harmful interference in a residential installation. This equipment generates, uses and can radiate radio frequency energy and, if not installed and used in accordance with the instructions, may cause harmful interference to radio communications. However, there is no guarantee that interference will not occur in a particular installation. If this equipment does cause harmful interference to radio or television reception, which can be determined by turning the equipment off and on, the user is encouraged to try to correct the interference by one or more of the following measures:

1. Reorient / Relocate the receiving antenna.
 2. Increase the separation between the equipment and receiver.
 3. Connect the equipment into an outlet on a circuit different from that to which the receiver is connected.
-

4. Consult the dealer or an experienced radio/TV technician for help.

Caution: Changes or modifications not expressly approved by the manufacturer could void the user's authority to operate the equipment.

Disclaimer

The Vendor makes no representations or warranties with respect to the contents here of and specially disclaims any implied warranties of merchantability or fitness for any purpose. Further the Vendor reserves the right to revise this publication and to make changes from time to time in the contents here of without obligation to notify any party beforehand.

Duplication of this publication, in part or in whole, is not allowed without first obtaining the Vendor's approval in writing.

Trademarks and Remarks

MS-DOS, Windows, Windows NT, Windows 9x, Windows 2000 and Windows ME are products of Microsoft Corp, with its ownership of trademark, and are distributed by the Vendor under a license agreement.

All trademarks used in this manual are the property of their respective owners.

Copyright(C) 2000
All Rights Reserved

Canadian D.O.C. Statement

This digital apparatus does not exceed the Class B limits for radio noise emissions from digital apparatus as set out in the radio interference regulations of the Canadian Department of Communications.

Cet appareil numérique n'émet pas de bruits radioélectriques dépassant les limites appliqués aux appareils numériques de Class B prescrits dans le règlement du brouillage radioélectrique édicté par le ministère Des Communications du Canada.

Introduction	1-1
1 Motherboard Description	1-2
1.1 Features	1-2
1.1.1 Hardware	1-2
1.1.2 Software	1-7
1.1.3 Attachments.....	1-7
1.2 Motherboard Installation.....	1-8
1.2.1 Layout of Motherboard	1-8
1.3 Motherboard Quick Reference	1-9
1.3.1 Front Panel Connectors (JPANEL1)	1-10
1.3.2 ATX 20-pin Power Connector: JATXPWR1	1-12
1.3.3 Hard Disk Connectors: IDE1 / IDE2.....	1-13
1.3.4 Floppy Disk Connector: FDD1	1-13
1.4 Back Panel Connectors	1-14
1.4.1 PS/2 Mouse / Keyboard Connector: JKBMS1	1-14
1.4.2 Monitor Connector: JVGA1	1-15
1.4.3 Back Panel USB Connector: JUSB1	1-16
1.4.4 Front USB Header: JUSB2	1-17
1.5 Serial and Parallel Interface Ports	1-18
1.6 CPU Installation.....	1-23
1.6.1 CPU Installation Procedure: Socket 370	1-23
1.6.2 CPU Frequency Selection: JCLK1	1-24
1.6.3 CPU Ratio Selection: JCLK2	1-25

Contents

1.7 Jumper Settings	1-26
1.7.1 System Fan Connector: JSFAN1 & JSFAN2 (Optional)	1-27
1.7.2 Wake-On-LAN Connector: JWOL1	1-27
1.7.3 Wake-On-Modem Connector: JWOM1 (Optional)	1-27
1.7.4 CPU Fan Connector: JCFAN1	1-28
1.7.5 CMOS Function Selection: JCMOS1	1-28
1.8 DRAM Installation	1-29
1.8.1 DIMM	1-29
1.8.2 How to install a DIMM Module	1-31
1.9 Audio Subsystem	1-32
1.9.1 CD Audio-In Connectors: JCDIN1/JCDIN2	1-33
1.9.2 Telephony Connector: JTAD1	1-33
1.9.3 AUX Audio in Connector: JAUX1 (Optional)	1-34
1.9.4 AUDIO Connector: JAUDIO1	1-34
2. BIOS Setup	2-1
2.1 Main Menu	2-3
2.2 Standard CMOS Features	2-6
2.3 Advanced BIOS Features	2-9
2.4 Advanced Chipset Features	2-13
2.5 Integrated Peripherals	2-16
2.6 Power Management Setup	2-21
2.7 PnP/PCI Configurations	2-25
2.8 PC Health Status	2-28
2.9 Frequency / Voltage Control	2-29

3. Software Setup	3-1
3.1 Software List	3-1
3.2 Software Installation	3-2
3.3 Using Software.....	3-3
4. Trouble Shooting	4-1

Introduction

Congratulations on the purchase of your new system! This motherboard is designed to take advantage of the latest industry technology to provide you with the ultimate solution in data processing. In the tradition of its predecessors, this motherboard continues a commitment to reliability and performance and strives for full compliance and compatibility with industry software and hardware.

System Overview

- ▶ □ On board support for USB peripherals
- ▶ □ On board and IDE facilities for IDE devices such as hard disks and CD drives
- ▶ □ On board CNR slot to support high performance, low cost modem peripherals.
- ▶ □ On board audio facilities
- ▶ □ INTEL and VIA Cyrix serial Socket 370 CPU.
- ▶ □ Supports the VIA8605/686A(686B) serial chipset
- ▶ □ MICRO ATX form factor compliance

Support for popular operating systems such as Windows 95/98, Windows NT, Windows 2000, Windows ME, Novell, OS/2, UNIX, SCO UNIX, LINUX (Red Hat 7.0).

1 Motherboard Description

1.1 Features

1.1.1 Hardware

CPU

- Supports the Celeron™ processor (PPGA) and the Pentium®!!! Micro-Processor and VIA Cryix III processor for high-end workstations and servers.
- CPU Socket 370 .
- Runs at 66/100 or 133MHz Front Side Bus frequency.

Speed

- Supports from 233MHz to 933MHz CPU core speeds.
- Supports 33 MHz PCI Bus speed.

DRAM Memory

- Supports three 8/16/32/64/128/256MB DIMM module sockets.
- Supports Synchronous DRAM (3.3V).
- Supports a maximum memory size of 1.5GB with SDRAM.
- 133MHz Bus frequency.

Green Function

- Supports power management operation via BIOS.
- Power down timer from 1 min to 1 hour.
- Wake On LAN connector.
- System Wake by any key activity.(Optional)

Universal Serial Bus

- USB v.1.1 and Intel Universal HCI v.1.1 compatible.
- Eighteen level (doublewords) data FIFO with full scatter and gather capability.
- Root hub and four function ports.
- Intrgrated physical layer transceivers with optional over-current detection status on USB inputs.
- Keyboard and mouse support.

PCI Enhanced IDE Built-in onboard

- Supports 4 IDE hard disk drives.
- Supports Mode 4, high performance hard disk drives.
- Supports Ultra DMA33/66, bus master mode.
- Supports IDE interface with CD-ROM.
- Supports high capacity hard disk drives.
- Supports LBA mode.
- Supports booting from LS-120 "SuperDisk" or Iomega™ ZIP disk.
- VT82C686B support Ultra DMA 33/66/100(optional).

Direct Sound Ready AC97 Digital Audio Controller

- Dual full-duplex Direct Sound channels between system memory and AC97 link.
- PCI master interface with scatter / gather and bursting capability.
- 32 byte FIFO of each direct sound channel.
- Host based sample rate converter and mixer.
- Standard v1.0 or v2.0 AC97 Codec interface for single or cascaded AC97 Codec's from multiple vendors.
- Loopback capability for re-directing mixed audio streams into USB and 1394 speakers.
- Hardware SoundBlaster Pro for Windows DOS box and real-mode Dos legacy compatibility.
- Plug and play with 4 IRQ, 4 DMA, and 4 I/O space options for SoundBlaster Pro and MIDI hardware.
- Hardware assisted FM synthesis for legacy compatibility.
- Direct two game ports and one MIDI port interface.
- Complete software driver support for Windows-95, Windows-98, Windows-NT, Windows 2000 and Windows ME.

Platform

- Micro ATX Form Factor.

Dimension

- 22.35 cm X 24.38 cm (W x L).

BUS Slots

- Provide one CNR slot only support the secondary codec is on the CNR (Modem function only) and one AGP (Pro/2X /4X) slot .
- Three 32-bit PCI bus master slots.
- PCI V2.2 compliant.

Power Management

- Supports both ACPI (Advanced and Configuration and Power Interface) and legacy (APM) power management.
- ACPI v1.0 Compliant.
- APM v1.2 Compliant.
- CPU clock throttling and clock stop control for complete ACPI C0 to C3 state support.
- PCI bus clock run, Power Management Enable (PME) control, and PCI/CPU clock generator stop control.
- Supports multiple system suspend types: power-on suspends with flexible CPU/PCI bus reset options and suspend to disk (soft-off), all with hardware automatic wake-up.
- Multiple suspend power plane controls and suspend status indicators.
- One idle timer, one peripheral timer and one general purpose timer, plus 24/32-bit ACPI compliant timer.
- Normal, doze, sleep, suspend, and conserve modes.
- Global and local device power control.
- System event monitoring with two event classes.
- Primary and secondary interrupt differentiation for individual channels.
- Dedicated input pins for power and sleep buttons, external modem ring indicator, and notebook lid open/close for system wake-up.
- Multiple internal and external SMI sources for flexible power management models.
- One programmable chip select and one microcontroller chip select.
- Enhanced integrated real time clock (RTC) with date alarm, month alarm, and century field.
- Thermal alarm on either external or any combination of two internal temperature sensing circuits.
- Hot docking support.
- I/O pad leakage control.

Super I/O Built-in onboard

- Support one multi-mode Parallel Port.
 - (1) Standard & Bidirection Parallel Port (SPP).
 - (2) Enhanced Parallel Port (EPP).
 - (3) Extended Capabilities Port (ECP).
- Supports two serial ports, 16550 UART with 16 byte FIFO.
- UART data rates up to 1.5 Mbaud.
- Supports one Infrared transmission (IR) port.
- Supports PS/2 Mouse.
- Supports 360KB, 720KB, 1.2MB, 1.44MB and 2.88MB floppy disk drives.

Full Featured Accelerated Graphics Port (AGP) Controller

- Synchronous and pseudo-synchronous with the CPU bus with optimal skew control.
- AGP v2.0 compliant.
- Supports SideBand Addressing (SBA) mode (non-multiplexed address / data).
- Supports 266 MHz 4x mode for AD and SBA signaling.
- Pipelined split-transaction long-burst transfers up to 1GB /sec.
- Eight level read request queue.
- Four level posted-write request queue.
- Thirty-two level (quadworks) read data FIFO (256 bytes).
- Sixteen level (quadworks) write data FIFO (128 bytes).
- Intelligent request reordering for maximum AGP bus utilization.
- Supports Flush/Fence commands.
- Graphics Address Relocation Table (GART).
 - (1) One level TLB structure.
 - (2) Sixteen entry fully associative page table.
 - (3) LRU replacement scheme.
 - (4) Independent GART lookup control for host /AGP /PCI master accesses.
- Windows 95 OSR-2 VXD and integrated Windows 98 / NT2000 /WINNT Windows ME miniport driver support.

Integrated Savage 4 2D/3D/Video Accelerator

- Optimized shared memory architecture (SMA).
 - Maximum 32MB frame buffer using system memory.
 - Floating point triangle setup engine.
 - Single cycle 128-bit 3D architecture.
 - 8M triangles/second setup engine.
 - 140M pixels/second trilinear fill rate.
 - Full AGP 4X, including sideband addressing and execute mode.
 - S3 DX7 texture compression (S3TC).
 - Next generation, 128-bit 2D graphics engine.
 - High quality DVD video playback.
- 2D/3D resolutions up to 1920 x 1440.

1.1.2 Software

BIOS

- AWARD legal & user-friendly BIOS.
- Supports PnP functions.

Operating Systems

- Offers the highest performance for MS-DOS OS/2, Windows NT, Windows 2000, Windows 31 / 95 / 98, Windows ME, Novell, UNIX, SCO UNIT, LINUX, and others.

1.1.3 Attachments

- HDD Cable.
- FDD Cable.
- USB2 Cable (Optional).
- CD for IDE / AGP / Chipset Driver, BIOS flash writer utility, Audio Driver, Manual.
- COM2 Cable (Optional).

1.2 Motherboard Installation

1.2.1 Layout of Motherboard

Model No.M6VSA

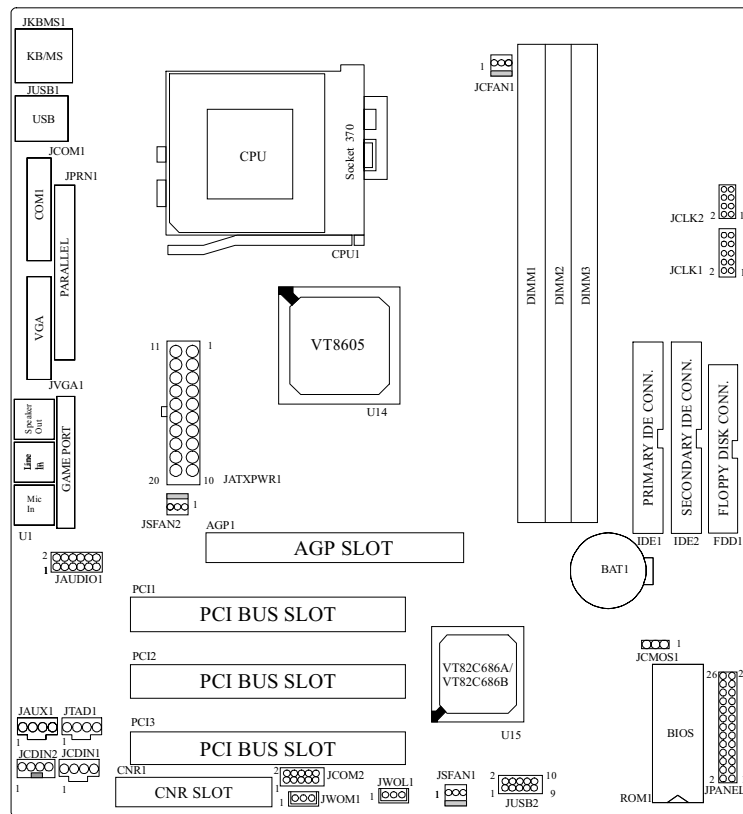

1.3 Motherboard Quick Reference

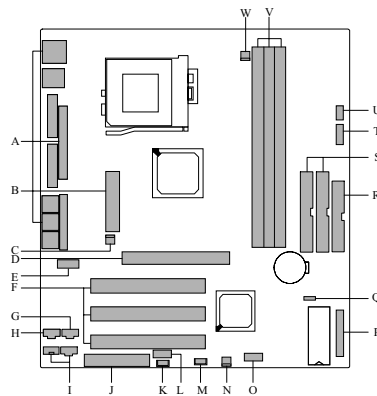

- | | |
|--|---|
| A. Back Panel I/O Connectors | M. Wake On LAN (JWOL1) |
| B. ATX Power Connector (JATXPWR1) | N. System Fan Connector (JSFAN1) |
| C. System Fan Connector (JSFAN2*) | O. Front USB Header (JUSB2) |
| D. AGP(Pro) Slot (AGP1) | P. Front Panel (JPANEL1) |
| E. Front Audio Connector (JAUDIO1) | Q. CMOS Function Select (JCMOS1) |
| F. PCI Bus Slots (PCI1-3) | R. FDD Connector (FDD1) |
| G. Telephony Connector (JTAD1) | S. IDE Connectors (IDE1-2) |
| H. AUX Audio in Connector (JAUX1*) | T. CPU Frequency Select (JCLK1) |
| I. CD Audio-IN Connector (JCDIN1-2) | U. CPU Ratio Select (JCLK2) |
| J. CNR Slot (CNR1) | V. DIMMs Socket (DIMM1-3) |
| K. Wake On Modem (JWOM1*) | W. CPU Fan Connector (JCFAN1) |
| L. Serial Port- II Header (JCOM2*) | |

NOTE: The “ * “ mark represent the function is optional.

1.3.1 Front Panel Connectors (JPANEL1)

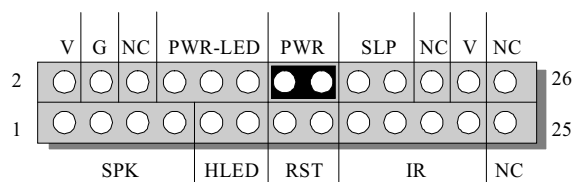

Pin No.	Assignment	Function	Pin No.	Assignment	Function
1	Speaker	Speaker Connector	2	+5V	VCC
3	NC		4	Ground	Ground
5	Ground		6	NC	NC
7	+5V		8	Power LED(+)	Power LED
9	HDD LED(+)	10	Power LED(+)		
11	HDD LED(-)	12	Ground		
13	Ground	Reset Button	14	Power Button	ATX Power Button
15	Reset Switch		16	Ground	
17	VCC	IrDA Connector	18	Sleep Switch	SLP
19	IRRX		20	Ground	
21	Ground		22	NC	NC
23	IRTX		24	+5V	VCC
25	NC	NC	26	NC	NC

Speaker Connector

An offboard speaker can be installed on the motherboard as a manufacturing option. An offboard speaker can be connected to the motherboard at the front panel connector. The speaker (onboard or offboard) provides error beep code information during the Power On Self-Test when the computer cannot use the video interface. The speaker is not connected to the audio subsystem and does not receive output from the audio subsystem.

Reset Button

This connector can be connected to a momentary SPST type switch that is normally open. When the switch is closed, the motherboard resets and runs the POST.

Power LED Connector

This connector can be connected to an LED that will light when the computer is powered on.

Hard Drive LED Connector

This connector can be connected to an LED to provide a visual indicator that data is being read from or written to a hard drive. For the LED to function properly, an IDE drive must be connected to the onboard hard drive controller.

Infrared Connector

After the IrDA interface is configured, files can be transferred from or to portable devices such as laptops, PDAs, and printers using application software.

SLP (Sleep/Resume Switch)

When APM is enabled in the system BIOS, and the operating system's APM driver is loaded, the system can enter sleep (standby) mode in one of the following ways:

- Optional front panel SMI button
- Prolonged system inactivity using the BIOS inactivity timer feature

The 2-pin header located on the front panel I/O connector supports a front panel SMI switch, which must be a momentary SPST type that is normally open.

Closing the SMI switch sends a System Management Interrupt (SMI) to the processor, which immediately goes into System Management Mode (SMM). While the computer is in sleep mode it is fully capable of responding to and servicing external interrupts (such as an incoming fax) even though the monitor turns on only if a keyboard or mouse interrupt occurs. To reactivate or resume the system, the SMI switch must be pressed again, or the keyboard or mouse must be used.

Power On Button

This connector can be connected to a front panel power switch. The switch must pull the Power Button pin to ground for at least 50 ms to signal the power supply to switch on or off. (The time requirement is due to internal denounce circuitry on the motherboard). At least two seconds must pass before the power supply will recognize another on/off signal.

1.3.2 ATX 20-pin Power Connector: JATXPWR1

This connector supports the power button on-board. Using the ATX power supply, functions such as Modem Ring Wake-Up and Soft Power Off are supported on this motherboard. This power connector supports instant power-on functionality, which means that the system will boot up instantly when the power connector is inserted on the board.

PIN	Assignment	PIN	Assignment
1	3.3 V	11	3.3 V
2	3.3 V	12	-12 V
3	Ground	13	Ground
4	5 V	14	PS_ON
5	Ground	15	Ground
6	5 V	16	Ground
7	Ground	17	Ground
8	PW_OK	18	-5 V
9	5V_SB	19	5 V
10	12 V	20	5 V

Warning: Since the motherboard has the instant power on function, make sure that all components are installed properly before inserting the power connector to ensure that no damage will be done.

1.3.3 Hard Disk Connectors: IDE1 / IDE2

The motherboard has a 32-bit Enhanced PCI IDE Controller that provides PIO Mode 0~4(5), Bus Master, and Ultra DMA 33/66/(100) functionality. It has two HDD connectors IDE1 (primary) and IDE2 (secondary). You can connect up to four hard disk drives, a CD-ROM, a 120MB Floppy (reserved for future BIOS) and other devices to IDE1 and IDE2. These connectors support the IDE hard disk cable provided.

- **IDE1 (Primary IDE Connector)**

The first hard drive should always be connected to IDE1. IDE1 can connect a Master and a Slave drive. You must configure the second hard drive on IDE1 to Slave mode by setting the jumper accordingly.

- **IDE2 (Secondary IDE Connector)**

The IDE2 controller can also support a Master and a Slave drive. The configuration is similar to IDE1. The second drive on this controller must be set to slave mode.

1.3.4 Floppy Disk Connector: FDD1

The motherboard provides a standard floppy disk connector (FDC) that supports 360K, 720K, 1.2M, 1.44M and 2.88M floppy disk types. This connector supports the provided floppy drive ribbon cables.

1.4 Back Panel Connectors

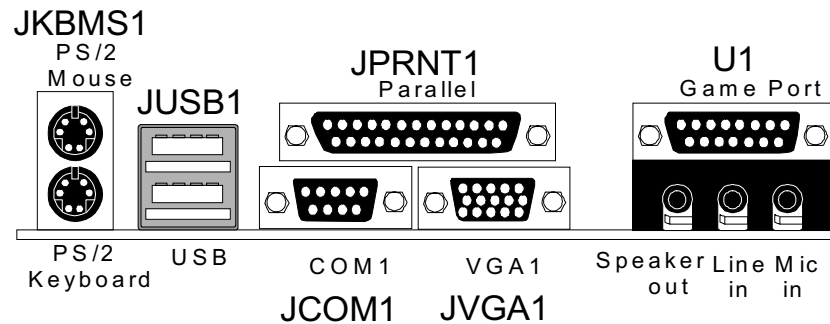

1.4.1 PS/2 Mouse / Keyboard Connector: JKBMS1

The motherboard provides a standard PS/2 mouse / Keyboard mini DIN connector for attaching a PS/2 mouse. You can plug a PS/2 mouse / Keyboard directly into this connector. The connector location and pin definition are shown below:

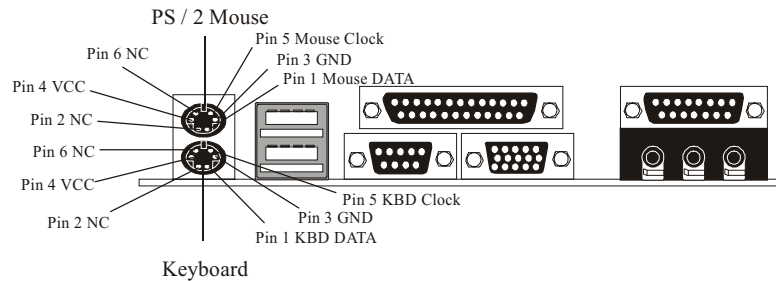

PS/2 Mouse / Keyboard Connectors

Pin	Assignment
1	Data
2	No connect
3	Ground
4	+5 V (fused)
5	Clock
6	No connect

1.4.2 Monitor Connector: JVGA1

This motherboard has built in video facilities. Your monitor will attach directly to JVGA1 connector on the motherboard.

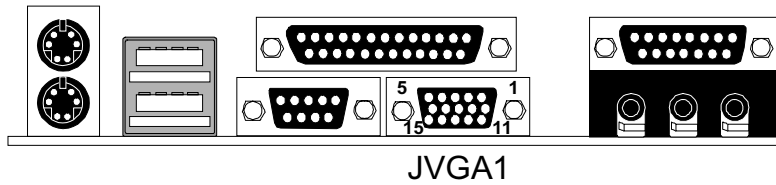

Pin	Assignment	Pin	Assignment
1	Red	2	Green
3	Blue	4	5V
5	Ground	6	Ground
7	Ground	8	Ground
9	5V	10	Ground
11	5V	12	DDC/Data
13	HS/NC	14	VSYNC
15	DDC/CLK		

1.4.3 Back Panel USB Connector: JUSB1

The motherboard provides a UHCI (Universal Host Controller Interface) Universal Serial Bus Roots for attaching USB devices such as keyboard, mouse and other USB devices. You can plug the USB Devices directly into this connector.

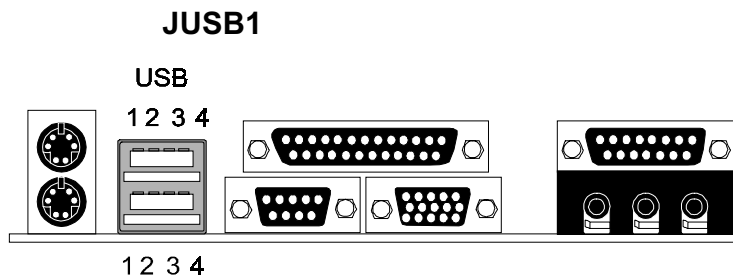

Stacked USB Connectors

Pin	Assignment
1	+5 V (fused)
2	USBP0- [USBP1-]
3	USBP0+ [USBP1+]
4	Ground

Note: (1) Signal names in brackets ([]) are for USB port 1.

1.4.4 Front USB Header: JUSB2

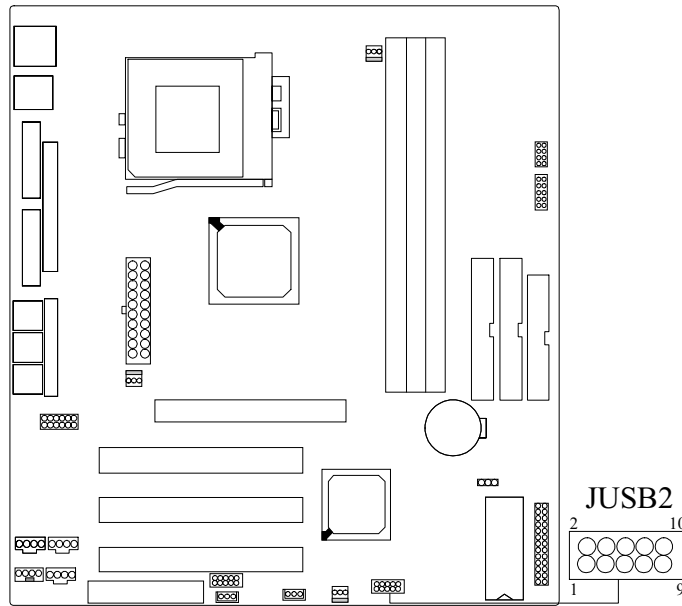

Pin	Assignment	Pin	Assignment
1	VCC	2	Ground
3	USBP2-	4	Ground
5	USBP2+	6	USBP3+
7	Ground	8	USBP3-
9	Ground	10	+5V(fused)

1.5 Serial and Parallel Interface Ports

This system comes equipped with two serial ports and one parallel port. Both types of interface ports will be explained in this chapter.

The Serial Interface Port-I : JCOM1

The serial interface port is sometimes referred to as an RS-232 port or an asynchronous communications port. Mice, printers, modems and other peripheral devices can be connected to a serial port. The serial port can also be used to connect your computer with another computer system. If you wish to transfer the contents of your hard disk to another system it can be accomplished by using each machine's serial port.

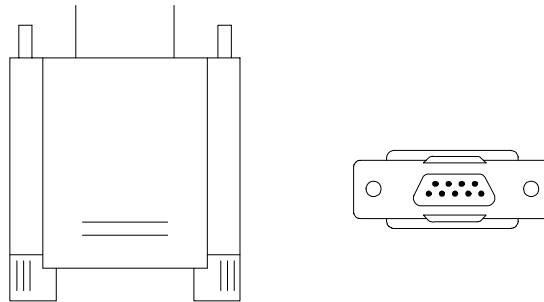

The serial ports on this system have two 9-pin connectors. Some older computer systems and peripherals used to be equipped with only one 25-pin connector. As you need to connect your 9-pin serial port to an older 25-pin serial port, you can purchase a 9-to-25 pin adapter.

Connectivity

The serial port can be used many ways, and it may be necessary to become familiar with the pin-out diagram. The following chart gives you the function of each pin on the 9-pin connector and some of the 25-pin connector. This information can be used when configuring certain software programs to work with the serial port.

Signal	Name	DB9 PIN	DB25 PIN
DCD	Data Carrier Detect	1	8
RX	Receive Data	2	3
TX	Transmit Data	3	2
DTR	Data Terminal Ready	4	20
GND	Signal Ground	5	7
DSR	Data Set Ready	6	6
RTS	Request to Send	7	4
CTS	Clear to Send	8	5
RI	Ring Indicator	9	22

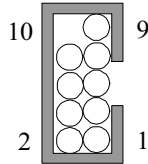
The Serial Interface Port-II : JCOM2 (Optional)

Signal	Name	IDC PIN
DCD	Data Carrier Detect	1
RX	Receive Data	2
TX	Transmit Data	3
DTR	Data Terminal Ready	4
GND	Signal Ground	5
DSR	Data Set Ready	6
RTS	Request to Send	7
CTS	Clear to Send	8
RI	Ring Indicator	9

Special Applications

There are two types of serial devices that can be connected to a serial port. One of the devices is called “DTE” (Data Terminal Equipment) and the other device is called “DCE” (Data Communications Equipment). If a modem is connected to a computer, for example, the modem is called the DCE and the computer is called the DTE. In situations such as this, the pins on the serial ports can be connected straight through.

In instances when there are two DTE devices connected together, such as a computer and a printer, a special adapter called a “Null Modem” is needed to make communication between the two devices possible.

When using the serial port to communicate between devices, one problem in particular may arise. Some manufacturers use one set of signals to begin communication with another device and other manufacturers do not use these

signals to initiate communication. If you encounter a communication problem that cannot be resolved using a null modem, it can generally be assumed that one device is using the initialization signals and the other device is not. This can usually be resolved by wiring the RTS, CTS, and DCD pins together.

Serial Ports/COM Ports

The two serial ports on the computer are called COM1 and COM2, respectively. If you wish, two more serial ports can be added onto the computer using optional hardware. Should you choose to add the extra Serial ports (COM ports) they would be called COM3 and COM4.

When using serial ports to communicate with a peripheral device, be sure to assign only one COM port number to each device. For example, if a printer and a scanner are both connected to your computer through serial ports, the printer must be assigned one COM port (i.e. COM1) and the scanner must be assigned the other COM port (i.e. COM2). No two devices can be assigned to one COM port. Each peripheral must have its own COM port.

NOTE: Four serial ports may be installed on the computer. However, no more than two ports can be used simultaneously.

*If you have installed an internal modem, be careful not to assign a COM port number that has already been assigned to another device. This error is common.

When installing a device that is going to require the use of a serial port, use a diagnostic program to find out which ports are available. It may be necessary to remove expansion cards that have serial ports in order to check their jumper settings. The jumper settings will indicate which COM port the card has been assigned. Checking the expansion card will eliminate mistakes in overlapping COM ports. Once you have completed the installation of peripheral devices using the serial ports, be sure that the communication parameters such as baud rate, parity bit, etc. are matching. If your computer is set for a baud rate of 9600 and your modem is set for a baud rate of 2400 you will not be able to send messages. The manuals that accompany the peripheral devices will inform you on the procedure for setting their parameters. Software manuals also have instructions on setting parameters.

Parallel Interface Port : JPRNT1

Unlike the serial port, parallel interface ports have been standardized and should not present any difficulty interfacing peripherals to your system. Sometimes called a Centronics port, the parallel port is almost exclusively used with printers. The parallel port on your system has a 25-pin, DB25 connector (see picture below). The pin-out for the parallel port are shown in the table below.

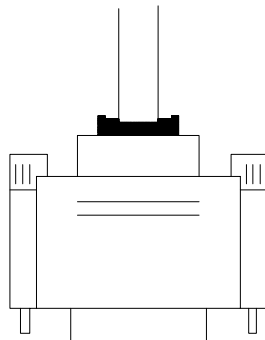
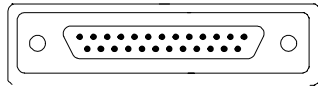

Signal	Pin
-Strobe	1
Data 0	2
Data 1	3
Data 2	4
Data 3	5
Data 4	6
Data 5	7
Data 6	8
Data 7	9
-Ack	10
Busy	11
Paper Empty	12
+Select	13
-Auto FDXT	14
-Error	15
-Init	16
-SLCTN	17
Ground	18
Ground	19
Ground	20
Ground	21
Ground	22
Ground	23
Ground	24
Ground	25

1.6 CPU Installation

1.6.1 CPU Installation Procedure: Socket 370

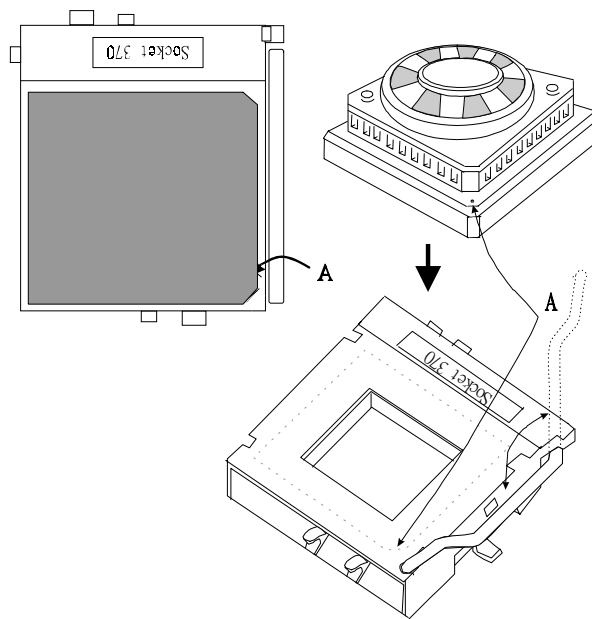

1. Pull the lever sideways away from the socket then raise the lever up to a 90-degree angle.
2. Locate Pin A in the socket and look for the white dot or cut edge in the CPU. Match Pin A with the white dot/cut edge then insert the CPU.
3. Press the lever down to complete the installation.

1.6.2 CPU Frequency Selection: JCLK1

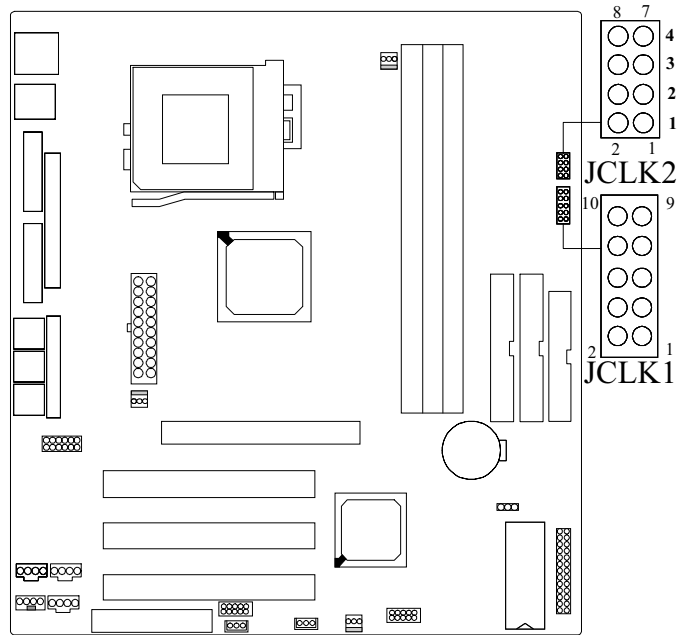

JCLK1 FREQ.	1-2	3-4	5-6	7-8
66MHz	OPEN	OPEN	CLOSE	CLOSE
100MHz	OPEN	OPEN	OPEN	CLOSE
133MHz	OPEN	OPEN	OPEN	OPEN

NOTES: If JCLK1 (Pin 9-10) set to open, the CPU frequency will be detected by the system automatically. Set to close, the CPU frequency is selectable.

1.6.3 CPU Ratio Selection: JCLK2

JCLK2 RATIO	1	2	3	4
x 2.0	CLOSE	CLOSE	CLOSE	CLOSE
x 2.5	CLOSE	CLOSE	OPEN	CLOSE
x 3.0	CLOSE	OPEN	CLOSE	CLOSE
x 3.5	CLOSE	OPEN	OPEN	CLOSE
x 4.0	OPEN	CLOSE	CLOSE	CLOSE
x 4.5	OPEN	CLOSE	OPEN	CLOSE
x 5.0	OPEN	OPEN	CLOSE	CLOSE
x 5.5	OPEN	OPEN	OPEN	CLOSE
x 6.0	CLOSE	CLOSE	CLOSE	OPEN
x 6.5	CLOSE	CLOSE	OPEN	OPEN
x 7.0	CLOSE	OPEN	CLOSE	OPEN
x 7.5	CLOSE	OPEN	OPEN	OPEN
x 8.0	OPEN	CLOSE	CLOSE	OPEN

1.7 Jumper Settings

The jumper has two or more pins, which can be covered by a plastic jumper cap, allowing you to select different system options.

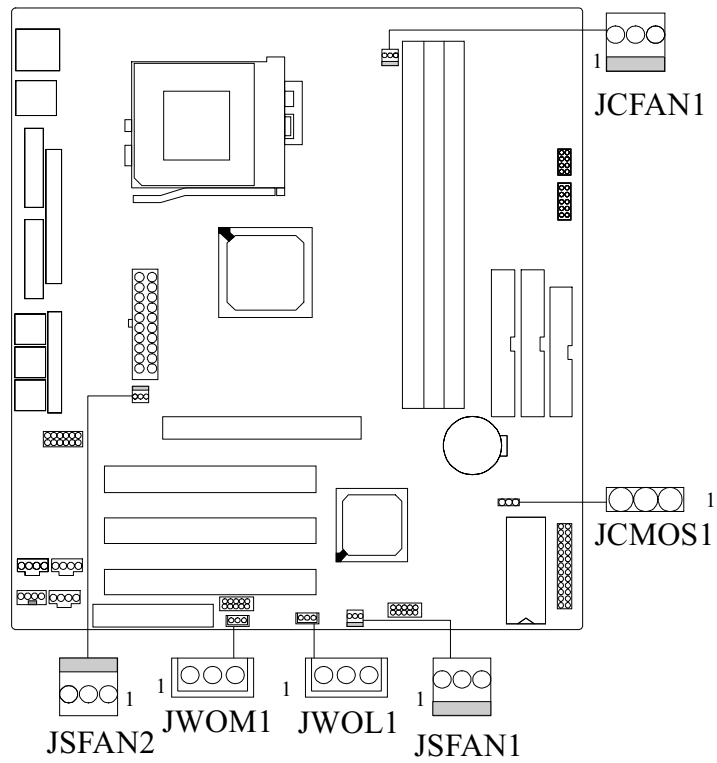

1.7.1 System Fan Connector: JSFAN1 & JSFAN2 (Optional)

JSFAN1

Pin No.	Assignment
1	Ground
2	+12 V
3	Sensor

JSFAN2

Pin No.	Assignment
1	Ground
2	+12 V
3	N.C.

1.7.2 Wake-On-LAN Connector: JWOL1

Pin No.	Assignment
1	5V_SB
2	Ground
3	Wake-up

1.7.3 Wake-On-Modem Connector: JWOM1(Optional)

Pin No.	Assignment
1	5V_SB
2	Ground
3	Wake-up

1.7.4 CPU Fan Connector: JCFAN1

Pin No.	Assignment
1	Ground
2	+12 V
3	Sensor

1.7.5 CMOS Function Selection: JCMOS1

This jumper is set during the process of clearing BIOS configurations which may be necessary in certain circumstances (i.e. forgotten BIOS passwords)

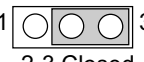
JCMOS1	Assignment
 1-2 Closed	Normal Operation (default)
 2-3 Closed	Clear CMOS Data



The following procedures are for resetting the BIOS password. It is important to follow these instructions closely.

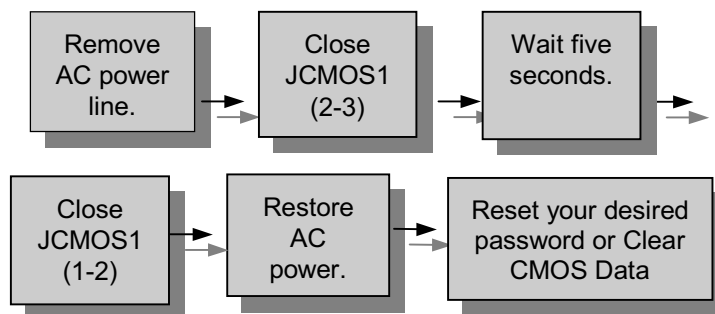

1.8 DRAM Installation

1.8.1 DIMM

DRAM Access Time: 3.3V Unbuffered SDRAM PC66/ PC100 / PC133 Type required.

DRAM Type: 8MB/16MB/32MB/64MB/128MB/256MB DIMM Module (168pin)

Total Memory Size (MB)	Bank 0 DIMM1	Bank 1 DIMM2	Bank 2 DIMM3
8 M	8M x 1 pc	----	----
16 M	16M x 1 pc	----	----
32 M	32M x 1 pc	----	----
64 M	64M x 1 pc	----	----
128 M	128M x 1 pc	----	----
256 M	256M x 1 pc	----	----
16 M	8M x 1 pc	8M x 1 pc	----
32 M	16M x 1 pc	16M x 1 pc	----
64 M	32M x 1 pc	32M x 1 pc	----
128 M	64M x 1 pc	64M x 1 pc	----
256 M	128M x 1 pc	128M x 1 pc	----
512 M	256M x 1 pc	256M x 1 pc	----
24 M	8M x 1 pc	8M x 1 pc	8M x 1 pc
40 M	16M x 1 pc	16M x 1 pc	8M x 1 pc
72 M	32M x 1 pc	32M x 1 pc	8M x 1 pc
136 M	64M x 1 pc	64M x 1 pc	8M x 1 pc
264 M	128M x 1 pc	128M x 1 pc	8M x 1 pc
520 M	256M x 1 pc	256M x 1 pc	8M x 1 pc
32 M	8M x 1 pc	8M x 1 pc	16M x 1 pc
48 M	16M x 1 pc	16M x 1 pc	16M x 1 pc
80 M	32M x 1 pc	32M x 1 pc	16M x 1 pc
144 M	64M x 1 pc	64M x 1 pc	16M x 1 pc
272 M	128M x 1 pc	128M x 1 pc	16M x 1 pc
528 M	256M x 1 pc	256M x 1 pc	16M x 1 pc
48 M	8M x 1 pc	8M x 1 pc	32M x 1 pc
64 M	16M x 1 pc	16M x 1 pc	32M x 1 pc
96 M	32M x 1 pc	32M x 1 pc	32M x 1 pc
160 M	64M x 1 pc	64M x 1 pc	32M x 1 pc
288 M	128M x 1 pc	128M x 1 pc	32M x 1 pc
544 M	256M x 1 pc	256M x 1 pc	32M x 1 pc
80 M	8M x 1 pc	8M x 1 pc	64M x 1 pc
96 M	16M x 1 pc	16M x 1 pc	64M x 1 pc
128 M	32M x 1 pc	32M x 1 pc	64M x 1 pc
192 M	64M x 1 pc	64M x 1 pc	64M x 1 pc
320 M	128M x 1 pc	128M x 1 pc	64M x 1 pc
576 M	256M x 1 pc	256M x 1 pc	64M x 1 pc

Total Memory Size (MB)	Bank 0 DIMM1	Bank 1 DIMM2	Bank 2 DIMM3
144 M	8M x 1 pc	8M x 1 pc	128M x 1 pc
160 M	16M x 1 pc	16M x 1 pc	128M x 1 pc
192 M	32M x 1 pc	32M x 1 pc	128M x 1 pc
256 M	64M x 1 pc	64M x 1 pc	128M x 1 pc
384 M	128M x 1 pc	128M x 1 pc	128M x 1 pc
640 M	256M x 1 pc	256M x 1 pc	128M x 1 pc
272 M	8M x 1 pc	8M x 1 pc	256M x 1 pc
288 M	16M x 1 pc	16M x 1 pc	256M x 1 pc
320 M	32M x 1 pc	32M x 1 pc	256M x 1 pc
384 M	64M x 1 pc	64M x 1 pc	256M x 1 pc
512 M	128M x 1 pc	128M x 1 pc	256M x 1 pc
768 M	256M x 1 pc	256M x 1 pc	256M x 1 pc

*The list shown above for DRAM configuration is only for reference.

1.8.2 How to install a DIMM Module

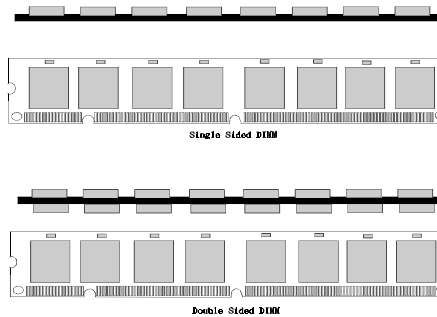

1. The DIMM socket has a "Plastic Safety Tab" and the DIMM memory module has an "asymmetrical notch", so the DIMM memory module can only fit in one direction.

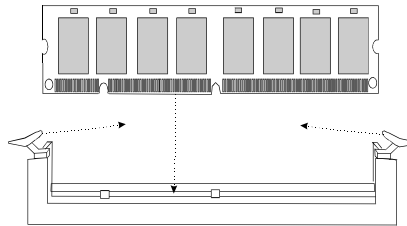

2. Push the tabs out. Insert the DIMM memory modules into the socket at 90-degree angle then push down vertically so that it will fit into place.
3. The Mounting Holes and plastic tabs should fit over the edge and hold the DIMM memory modules in place.

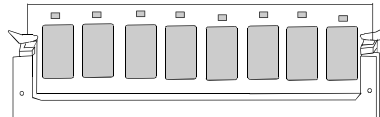

1.9 Audio Subsystem

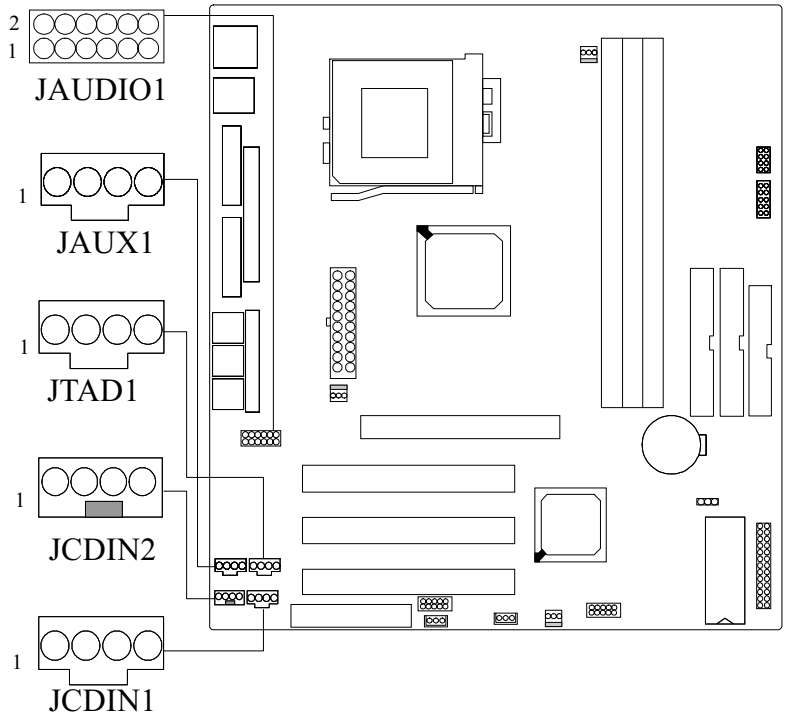

1.9.1 CD Audio-In Connectors: JCDIN1/JCDIN2

(For 2.54 mm Pitch)

Pin No. of JCDIN1	Assignment
1	Right Channel Input
2	CD_Ground
3	CD_Ground
4	Left Channel Input

(For 2.0 mm Pitch)

Pin No. of JCDIN2	Assignment
1	Left Channel Input
2	CD_Ground
3	Right Channel Input
4	CD_Ground

1.9.2 Telephony Connector: JTAD1

Pin No. of JTAD1	Assignment
1	MONO_In
2	CD_Ground
3	CD_Ground
4	MONO_Out

1.9.3 AUX Audio in Connector: JAUX1 (Optional)

Pin No. of JAUX1	Assignment
1	Left channel AUX_IN
2	CD_Ground
3	CD_Ground
4	Right channel AUX_IN

1.9.4 AUDIO Connector: JAUDIO1

Pin No. of JAUDIO1	Assignment
1	A Line_L
2	A Line_R
3	Line_O_L
4	Line_O_R
5	Ground
6	Ground
7	Line_I_L
8	Line_I_R
9	Ground
10	N.C
11	Mic_in2
12	Ground

2. BIOS Setup

Introduction

This manual discussed Award™ Setup program built into the ROM BIOS. The Setup program allows users to modify the basic system configuration. This special information is then store in battery-backed RAM so that it retains the Setup information when the power is turned off.

The Award BIOS™ installed in your computer system's ROM (Read Only Memory) is a custom version of an industry standard BIOS. This means that it supports Intel processors in a standard IBM-AT compatible input/output system. The BIOS provides critical low-level support for standard devices such as disk drives and serial and parallel ports.

Adding important has customized the Award BIOS™, but nonstandard, features such as virus and password protection as well as special support for detailed fine-tuning of the chipset controlling the entire system.

The rest of this manual is intended to guide you through the process of configuring your system using Setup.

Plug and Play Support

These AWARD BIOS supports the Plug and Play Version 1.0A specification. ESCD (Extended System Configuration Data) write is supported.

EPA Green PC Support

This AWARD BIOS supports Version 1.03 of the EPA Green PC specification.

APM Support

These AWARD BIOS supports Version 1.1&1.2 of the Advanced Power Management (APM) specification. Power management features are implemented via the System Management Interrupt (SMI). Sleep and Suspend power management modes are supported. Power to the hard disk drives and video monitors can be managed by this AWARD BIOS.

PCI Bus Support

This AWARD BIOS also supports Version 2.1 of the Intel PCI (Peripheral Component Interconnect) local bus specification. Please see the Intel technical documentation for additional information.

DRAM Support

SDRAM (Synchronous DRAM) are supported.

Supported CPUs

This AWARD BIOS supports a single Intel CPU or VIA Cryix III CPU.

Using Setup

In general, you use the arrow keys to highlight items, press <Enter> to select, use the PageUp and PageDown keys to change entries, press <F1> for help and press <Esc> to quit. The following table provides more detail about how to navigate in the Setup program using the keyboard.

Keystroke	Function
Up arrow	Move to previous item
Down arrow	Move to next item
Left arrow	Move to the item on the left (menu bar)
Right arrow	Move to the item on the right (menu bar)
Esc	Main Menu: Quit without saving changes Submenus: Exit Current page to the next higher level menu
Move Enter	Move to the item you desired
PgUp key	Increase the numeric value or make changes
PgDn key	Decrease the numeric value or make changes
+ Key	Increase the numeric value or make changes
- Key	Decrease the numeric value or make changes
Esc key	Main Menu – Quit and not save changes into CMOS Status Page Setup Menu and Option Page Setup Menu – Exit Current page and return to Main Menu
F1 key	General help on Setup navigation keys
F5 key	Load previous values from CMOS
F6 key	Load the fail-safe defaults from BIOS default table
F7 key	Load the optimized defaults
F9 key	Manual in BIOS
F10 key	Save all the CMOS changes and exit

2.1 Main Menu

Once you enter Award BIOS™ CMOS Setup Utility, the Main Menu will appear on the screen. The Main Menu allows you to select from several setup functions and two exit choices. Use the arrow keys to select among the items and press <Enter> to accept and enter the sub-menu.

!! WARNING !!

The information about BIOS defaults on manual (**Figure 1,2,3,4,5,6,7,8,9**) is just for reference, please refer to the BIOS installed on board, for update information.

■ Figure 1. Main Menu

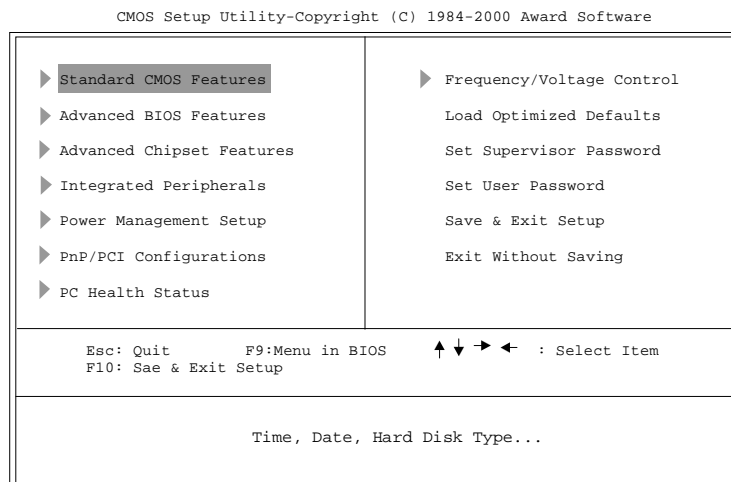

Standard CMOS Features

This setup page includes all the items in a standard compatible BIOS.

Advanced BIOS Features

This setup page includes all the items of BIOS special enhanced features.

Advanced Chipset Features

This setup page includes all the items of chipset special features.

Integrated Peripherals

This section page includes all the items of IDE hard drive and Programmed Input/Output features.

Power Management Setup

This setup page includes all the items of power management features.

PnP/PCI Configurations

This setup page includes IRQ Setting by user define or default.

PC Health Status

This setup page is the System auto detect Temperature, voltage, fan speed.

Frequency/Voltage Control

This submenu allows you to specify your setting for frequency/voltage control.

Load Optimized Defaults

These settings are more likely to configure a workable computer when something is wrong. If you cannot boot the computer successfully, select the BIOS Setup options and try to diagnose the problem after the computer boots. These settings do not provide optimal performance.

Load Optimized Defaults (Y/N)?N

Set Supervisor Password

Change, set, or disable password. It allows you to limit access to the system and Setup, or just to Setup.

Enter Password:

Set User Password

You can specify both a User and a Supervisor password. When you select either password option, you are prompted for a 1-6-character password. Enter the password and then retype the password when prompted.

Enter Password:

Save & Exit Setup

Save CMOS value changes to CMOS and exit setup.

SAVE to CMOS and EXIT (Y/N)? Y

Exit Without Saving

Abandon all CMOS value changes and exit setup.

Quit without Saving (Y/N)? N

2.2 Standard CMOS Features

The items in Standard CMOS Setup Menu are divided into 10 categories. Each category includes no, one or more than one setup items. Use the arrow keys to highlight the item and then use the <PgUp> or <PgDn> keys to select the value you want in each item.

■ Figure 2. Standard CMOS Setup

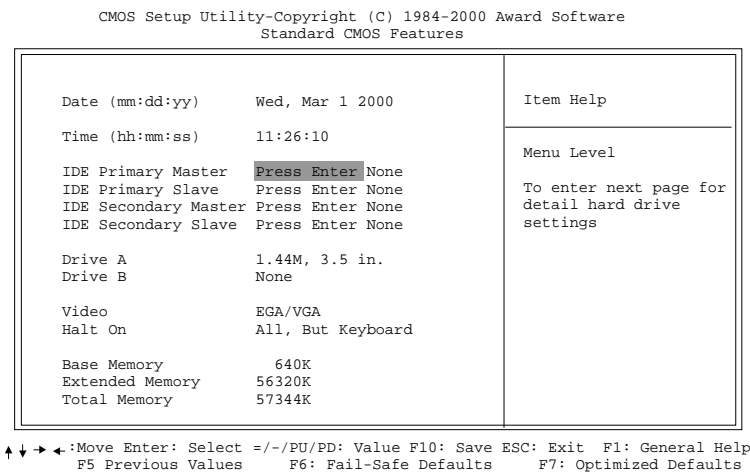

Main Menu Selections

This table shows the selections that you can make on the Main Menu.

Item	Options	Description
Date	MM DD YYYY	Set the system date. Note That the 'Day' automatically changes when you set the date.
IDE Primary Master	Options are in its sub menu.	Press <Enter> to enter the sub menu of detailed options
IDE Primary Slave	Options are in its sub menu.	Press <Enter> to enter the sub menu of detailed options.
IDE Secondary Master	Options are in its sub menu.	Press <Enter> to enter the sub menu of detailed options.
IDE Secondary Slave	Options are in its sub menu.	Press <Enter> to enter the sub menu of detailed options.
Drive A Drive B	None 360K, 5.25 in 1.2M, 5.25 in 720K, 3.5 in 1.44M, 3.5 in 2.88M, 3.5 in	Select the type of floppy disk drive installed in your system.
Video	EGA/VGA CGA 40 CGA 80 MONO	Select the default video device.

Item	Options	Description
Halt On	All Errors No Errors All, but Keyboard All, but Diskette All, but Disk/Key	Select the situation in which you want the BIOS to stop the POST process and notify you.
Base Memory	N/A	Displays the amount of conventional memory detected during boot up.
Extended Memory	N/A	Displays the amount of extended memory detected during boot up.
Total Memory	N/A	Display the total memory available in the system.

2.3 Advanced BIOS Features

■ Figure 3. Advanced BIOS Setup

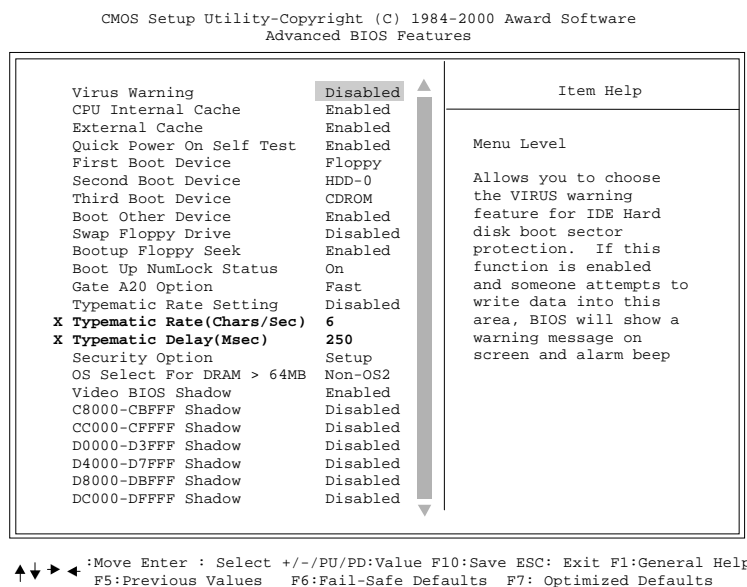

Virus Warning

Allows you to choose the VIRUS Warning feature for IDE Hard Disk boot sector protection. If this function is enabled and someone attempts to write data into this area, BIOS will show a warning message on screen and alarm beep.

Disabled (default)

No warning message appears when anything attempts to access the boot sector or hard disk partition table

Enabled

Activates automatically when the system boots up causing a warning message to appear when anything attempts to access the boot sector of hard disk partition table

CPU Internal Cache

These two categories speed up memory access. However, it depends on CPU/chipset design.

Enabled (default)	Enable cache
Disabled	Disable cache

External Cache

These fields allow you to Enable or Disable the CPU's "Level 2" secondary cache. Caching allows better performance.

Enabled (default)	Enable cache
Disabled	Disable cache

Quick Power On Self Test

This category speeds up Power on Self-Test (POST) after you power up the computer. If it is set to Enable, BIOS will shorten or skip some check items during POST.

Enabled (default)	Enable quick POST
Disabled	Normal POST

First /Second/Third/Other Boot Device

These BIOS attempts to load the operating system from the devices in the sequence selected in these items.

The Choices: Floppy, LS120, HDD-0, SCSI, HDD-1, HDD-2, HDD-3, LAN, Disabled, **CDROM**(default), Enabled

Swap Floppy Drive

For system with two floppy drives, this option allows you to swap logical drive assignments.

The Choices: Enabled, **Disabled** (default)

Boot Up Floppy Seek

Seek disk drives during boot up. Disabling speeds boot up.

The Choices: **Enabled** (default), Disabled

Boot Up NumLock Status

Select power on state for NumLock.

- | | |
|---------------------|-----------------------|
| On (default) | Numpad is number keys |
| Off | Numpad is arrow keys |

Gate A20 Option

Select if chipset or keyboard controller should control GateA20.

- | | |
|-----------------------|---|
| Normal | A pin in the keyboard controller controls GateA20 |
| Fast (default) | Lets chipset control GateA20 |

Typematic Rate Setting

Keystorke repeat at a rate determined by the keyboard controller. When enabled, the typematic rate and typematic delay can be selected.

The Choices: Enabled, **Disabled** (default)

Typematic Rate (Chars/Sec)

Sets the number of times a second to repeat a keyboard when you hold the key down.

The Choices: 6 (Default), 8, 10, 12, 15, 20, 24, 30

Security Option

Select whether the password is required every time the system boots or only when you enter setup.

- | | |
|------------------------|--|
| System | The system will not boot and access to Setup will be denied if the correct password is not entered at the prompt |
| Setup (default) | The system will boot, but access to Setup will be denied if the correct password is not entered at the prompt |

Note: *To disable security, select PASSWORD SETTING at Main Menu and then you will be asked to enter password. Do not type anything and just press <Enter>, it will disable security. Once the security is disabled, the system will boot and you can enter Setup freely.*

OS Selection for DRAM > 64MB

Select the operating system that is running with greater than 64MB of RAM on the system.

The Choices: Non-OS2 (default), OS2

Video BIOS Shadow

Determines whether video BIOS will be copied to RAM for faster execution.

Enabled (default)	Optional ROM is enabled
Disabled	Optional ROM is disabled

C8000 - CFFFF Shadow / D0000 - DFFFF Shadow

Determines whether the optional ROM will be copied to RAM for faster execution.

Enabled	Optional ROM is shadowed
Disabled (default)	Optional ROM is not shadowed

Note : For C8000 - DFFFF option - ROM on PCI BIOS, BIOS will automatically enable the shadow RAM. User does not have to select the item.

2.4 Advanced Chipset Features

This section allows you to configure the system based on the specific features of the installed chipset. This chipset manages bus speeds and access to system memory resources, such as DRAM and the external cache. It also coordinates communications between the conventional PCI bus. It must be stated that these items should never need to be altered. The default settings have been chosen because they provide the best operating conditions for your system. The only time you might consider making any changes would be if you discovered that data was being lost while using your system.

■ Figure 4. Advanced Chipset Setup

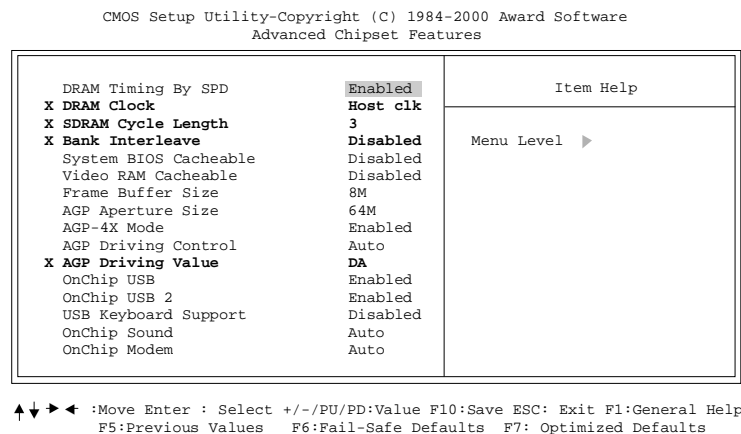

DRAM Timing By SPD

Use the SPD information of memory to set the optimum DRAM timing for memory operation.

The Choices: Enabled (default), Disabled

DRAM Clock

When synchronous DRAM is installed, the number of clock cycles of CAS latency depends on the DRAM timing.

The Choices: Host CLK(default), HCLK+33M

SDRAM Cycle Length

This specifies the DRAM clock speed.

The Choices: 3 (Default),2

Bank Interleave

This item allows you to set how many banks of SDRAM support in your mainboard.

The Choices: Disabled (default), 2Bank, 4Bank

System BIOS Cacheable

Selecting Enabled allows caching of the system BIOS ROM at F0000h-FFFFh, resulting in better system performance. However, if any program writes to this memory area, a system error may result.

The Choices: Disabled (default), Enabled

Video RAM Cacheable

Select Enabled allows caching of the video BIOS, resulting in better system performance. However, if any program writes to this memory area a system may result.

The Choices: Disabled (default), Enabled

Frame Buffer Size

This item allows you to control the VGA frame buffer size.

The Choices: 8M (default), 16M, 32M

AGP Aperture Size

This field lets you insert a timing delay between the CAS and RAS strobe signals, used when DRAM is written to, read from, or refreshed. Fast gives faster performance; and *Slow* gives more stable performance. This field applies only when synchronous DRAM is installed in the system.

The Choices: 64M (default), 32M, 16M, 8M, 4M, 128M

AGP-4X Mode

If an insufficient number of cycles is allowed for RAS to accumulate its charge before DRAM refresh, the refresh may be incomplete and the DRAM may fail to retain data. Fast gives faster performance; and Slow gives more stable performance. This field applies only when synchronous DRAM is installed in the system.

The Choices: Enabled (default), Disabled

AGP Driving Control

The option determine the AGP Output Buffer Drive Strength.

The Choices: Auto (default), Manual

AGP Driving Value

The option determine the AGP Output Buffer Drive Strength.

The Choice: DA (default)

OnChip USB/USB2

This should be enabled if your system has a USB install on the system board and you wish to use it. Even when so equipped, if you add a higher performance controller, you will need to disable this feature.

The Choices: Enabled (default), Disabled

USB Keyboard Support

Select Enabled if your system contains a Universal Serial Bus (USB) controller and you have a USB keyboard.

The Choices: Disabled (default), Enabled

OnChip Sound

The default setting for this option (Auto) implies that there is an on board sound chip for audio output. You will need to disable this option if you are going to install a sound card.

The Choices: Auto (default), Disabled

OnChip Modem

Select Enabled allows caching of the video BIOS, resulting in better system performance. However, if any program writes to this memory area, a system error may result.

The Choices: Auto (default), Disabled

2.5 Integrated Peripherals

■ Figure 5. Integrated Peripherals

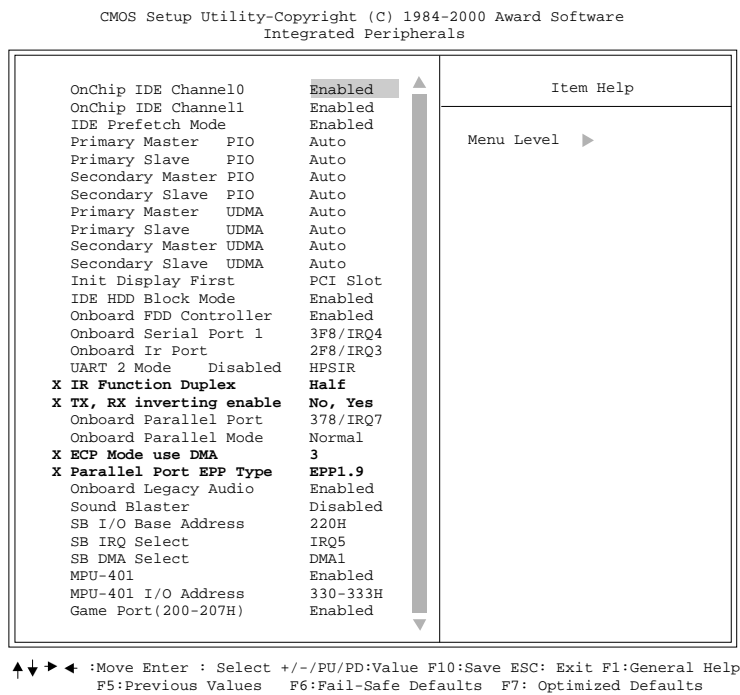

OnChip IDE Channel 0

The integrated peripheral controller contains an IDE interface with support for two IDE channels. Select Enabled to activate each channel separately.

The Choices: Enabled (default), Disabled

OnChip IDE Channel 1

The integrated peripheral controller contains an IDE interface with support for two IDE channels. Select Enabled to activate each channel separately.

The Choices: Enabled (default), Disabled

IDE Prefetch Mode

The “onboard” IDE drive interfaces supports IDE prefetching for faster drive access. If the interface dose not support prefetching, or if you install a primary and/or secondary add-in IDE interface, set this option to “Disabled”.

The Choices: Enabled(default), Disabled

Primary / Secondary Master / Slave PIO

The IDE PIO (Programmed Input / Output) fields let you set a PIO mode (0-4) for each of the IDE devices that the onboard IDE interface supports. Modes 0 through 4 provide successively increased performance. In Auto mode, the system automatically determines the best mode for each device.

The Choices: Auto (default), Mode0, Mode1, Mode2, Mode3, Mode4

Primary / Secondary Master / Slave UDMA

Ultra DMA /33 implementation is possible only if your IDE hard drive supports it and the operating environment includes a DMA drive (Windows 95 OSR2 or a third party IDE bus master driver). If your hard drive and your system software both support Ultra DMA/33, select Auto to enable BIOS support.

The Choices: Auto (default), Disabled

Init Display First

This item allows you decide to active whether PCI Slot or on-chip VGA first.

The Choices: PCI Slot (default), AGP

IDE HDD Block Mode

Block mode is also called block transfer, multiple commands, or multiple sector read/write. If your IDE hard drive supports block mode (most new drives do), select Enabled for automatic detection of the optimal number of block mode (most new drives do), select Enabled for automatic detection of the optimal number of block read/writes per sector the drive can support.

The Choices: Enabled (default), Disabled

Onboard FDD Controller

Select Enabled if your system has a floppy disk controller (FDD) installed on the system board and you wish to use it. If install and FDD or the system has no floppy drive, select Disabled in this field.

The Choices: Enabled (default), Disabled

Onboard Serial Port 1

Select an address and corresponding interrupt for the first and second serial ports.

The Choices: 3F8/IRQ4(default), 2F8/IRQ3, 3E8/IRQ4, 2E8/IRQ3 , Auto, Disabled

Onboard IR Port

Select IR Address.

The Choices: Disabled, 3F8/IRQ4, 2F8/IRQ3(default), 3E8/IRQ4, 2E8/IRQ3, Auto

UART 2 Mode

This item allows you to determine which Infra Red (IR) function of onboard I/O chip.

The Choices: HPSIR (default), ASKIR

IR Function Duplex

This item allows you to decide to active IR transmission delay.

The Choice: Half (default), Full

Tx, Rx inverting enable

This item allows you to determine the active of Rx, Tx.

The Choice: No, Yes (default)

Onboard Parallel Port

This item allows you to determine access onboard parallel port controller with which I/O Address.

The Choices: 378/IRQ7 (default), 278/IRQ5, Disabled, 3BC/IRQ7

Parallel Port Mode

Select an operating mode for the onboard parallel (printer) port. Normal EPP (Extend Parallel Port) ECP (Extend Capabilities Port) ECP +EPP PC AT parallel port Bidirectional Port Fast, buffered port Fast, buffered, Bidirectional Port. Select Normal unless you are certain your hardware and software both support EPP or ECP mode.

The Choices: Normal (default), ECP,ECP/EPP,EPP

ECP Mode Use DMA

Select a DMA Channel for the port.

The Choice: 3 (default), 1

Parallel Port EPP type

Select a DMA Channel for the port.

The Choices: EPP1.9 (default),EPP1.7

Onboard Legacy Audio

Select an operating mode for the second serial port:

The choices: Enabled (default) , Disabled

Sound Blaster

Hardware SoundBlaster Pro for Windows DOS box and real-mode DOS legacy compatibility.

The Choices: Enabled, Disabled(default)

SB I/O Base Address

Change the SoundBlaster Pro Base I/O Address settings.

The Choices: 220H(default), 240H, 260H, 280H

SB IRQ Select

Change the SoundBlaster Pro interrupt signal.

The Choices: IRQ5(default), IRQ7, IRQ9, IRQ10

SB DMA Select

Change the SoundBlaster Pro direct memory access setting.

The Choices: DMA0, **DMA1**(default), DMA2, DMA3

MPU-401

Enable or Disable MPU-401 option.

The Choices: **Enabled**(default), Disabled

MPU-401 I/O Address

Change the SoundBlaster Pro MPU-401 I/O address.

The Choices: **330-333H**(default), 320-323H, 310-313H, 300-303H

Game Port (200-207H)

Change the joystick connect port address.

The Choices: **Enabled**(default), Disabled

2.6 Power Management Setup

The Power Management Setup allows you to configure your system to most effectively save energy while operating in a manner consistent with your own style of computer use.

■ Figure 6. Power Management Setup

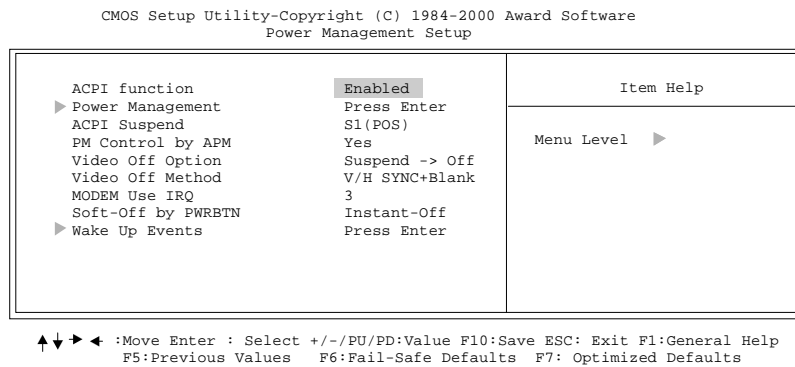

ACPI function

The item allows you to enable/disable the Advanced Configuration and Power Management (ACPI).

The Choices: Enabled (default), Disabled

Power Management

This category allows you to select the type (or degree) of power saving and is directly related to the following modes:

- 1.HDD Power Down.
- 2.Doze Mode.
- 3.Suspend Mode.

There are four selections for Power Management, three of which have fixed mode settings

MinSaving

Minimum power management. Doze Mode = 1 hr. Standby Mode = 1 hr., Suspend Mode = 1 hr., and HDD Power Down = 15 min.

MaxSaving	Maximum power management—ONLY AVAILABLE FOR SL CPU's. Doze Mode = 1 min., Standby Mode = 1 min., Suspend Mode = 1 min., and HDD Power Down = 1 min.
User Define (default)	Allows you to set each mode individually. When not disabled, each of the ranges are from 1 min. to 1 hr. except for HDD Power Down which ranges from 1 min. to 15 min. and disable.

ACPI Suspend Type

This item allows you to select the suspend type under ACPI operating system.

S1 (POS) (default) Power on Suspend

PM Control By APM

No System BIOS will ignore APM when Power Management is on

Yes(default) System BIOS will wait for ROM's prompt Before it enters any PM mode

Video Off Option

This determines the manner in which the monitor is blanked.

Suspend —> **Off** (default) During Suspend mode, the monitor will be turned off.

All Modes —> **Off** During All modes, the monitor will be turned off.

Always On During Always mode, the monitor will be turned on.

Video Off Method

This determines the manner in which the monitor is blanked.

V/H SYNC+Blank (default) This selection will cause the system to turn off the vertical and horizontal synchronization ports and write blanks to the video buffer.

DPMS Support Initial display power management signaling.

Blank Screen

This option only writes blanks to the video buffer.

MODEM Use IRQ

This determines the IRQ in which the MODEM can use.

The Choices: 3 (default), 4, 5, 7, 9, 10, 11, NA

Soft-Off by PWRBTN

Pressing the power button for more than 4 seconds forces the system to enter the Soft-Off state when the system has "hung".

The Choices: Delay 4 Sec, **Instant-Off** (default)

Wake Up Events

If you highlight the literal "Press Enter" next to the "Wake Up Events" label and then press the enter key, it will take you a submenu with the following options:

VGA

When set to on, any event occurring at a COM(serial)/LPT(printer)port will awaken a system which has been powered down.

LPT&COM

When select LPT/COM, any activity from one of the system peripheral devices or IRQs wakes up the system.

HDD&FDD

When set to On(default), any event occurring at a hard or floppy drive will awaken a system which has been powered down.

PCI MASTER

When set to On, any event occurring at PCI will awaken a system which has been powered down.

Wake Up On LAN/Ring

To use this function, you need a LAN add-on card which support power on function. It should also support the wake-up on LAN jump.

Disabled(default),Enabled

RTC Alarm Resume

When "Enabled", you can set the date and time at which the RTC (real-time clock) alarm awakens the system from Suspend mode.

Date of Month

You can choose which month the system will boot up.

Resume Time (hh: mm: ss)

You can choose the hour, minute and second the system will boot up.

Primary INTR

When set to ON (default), any event occurring at Primary INTR will awaken a system which has been powered down.

The following is a list of IRQ, Inter ReQuest, which can be exempted much as the COM ports and LPT ports above can. When an I/P device wants to gain the attention of the operating system, it signals this by causing an IRQ to occur. When the operating system is ready to respond to the request, it interrupts itself and performs the services.

As above, the choices are On and Off. Off is the default.

When set On, activity will neither prevent the system from going into a power management mode nor awaken it.

IRQS Activity Monitoring

IRQ3	(COM2)
IRQ4	(COM1)
IRQ5	(LPT2)
IRQ6	(Floppy Disk)
IRQ7	(LPT1)
IRQ8	(RTC Alarm)
IRQ9	(IRQ2 Redir)
IRQ10	(Reserved)
IRQ11	(Reserved)
IRQ12	(PS2/Mouse)
IRQ13	(Coprocessor)
IRQ14	(Hard Disk)
IRQ15	(Reserved)

2.7 PnP/PCI Configurations

This section describes configuring the PCI bus system. PCI, or Personal Computer Interconnect, is a system which allows I/O devices to operate at speeds nearing the speed the CPU itself uses when communicating with its own special components. This section covers some very technical items and it is strongly recommended that only experienced users should make any changes to the default settings.

■ Figure 7. PnP/PCI Configurations

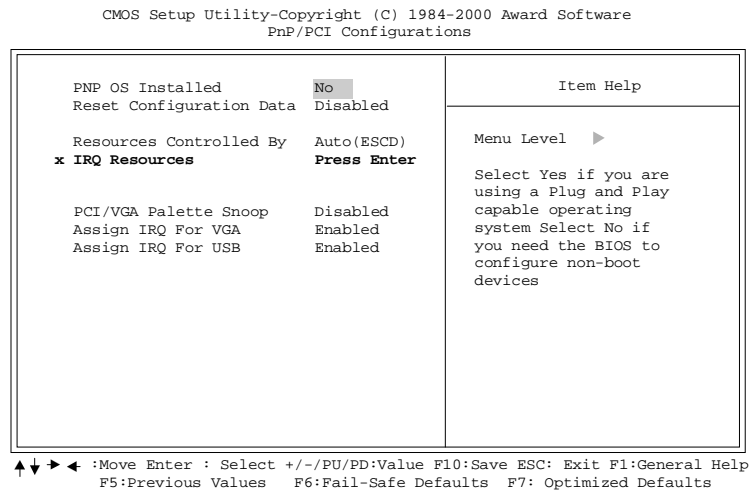

PNP OS Installed

When set to “YES”, BIOS will only initialize the PnP cards used for booting (VGA, IDE, SCSI). The rest of the cards will be initialized by the PnP operating systems, like WindowsTM95. When set to “NO”, BIOS will initialize all the PnP cards. Therefore for non-PnP operating system (DOS, NetwareTM), this option must set to “NO”.

Reset Configuration Data

The system BIOS supports the PnP feature so the system needs to record which resource is assigned and proceeds resources from conflict. Every peripheral device has a node, which is called ESCD. This node records which resources are assigned to it. The system needs to record and update ESCD to the memory locations. These locations (4K) are reserved at the system BIOS.

If Disabled (default) is chosen, the system's ESCD will update only when the new configuration varies from the last one.

If Enabled is chosen, the system is forced to update ESCDs and then is automatically set to the "Disabled" mode.

IRQ-3	assigned to : PCI / ISA PnP
IRQ-4	assigned to : PCI / ISA PnP
IRQ-5	assigned to : PCI / ISA PnP
IRQ-7	assigned to : PCI / ISA PnP
IRQ-9	assigned to : PCI / ISA PnP
IRQ-10	assigned to : PCI / ISA PnP
IRQ-11	assigned to : PCI / ISA PnP
IRQ-12	assigned to : PCI / ISA PnP
IRQ-14	assigned to : PCI / ISA PnP
IRQ-15	assigned to : PCI / ISA PnP
DMA-0	assigned to : PCI / ISA PnP
DMA-1	assigned to : PCI / ISA PnP
DMA-3	assigned to : PCI / ISA PnP
DMA-5	assigned to : PCI / ISA PnP
DMA-6	assigned to : PCI / ISA PnP
DMA-7	assigned to : PCI / ISA PnP

The above settings will be shown on the screen only if "Manual" is chosen for the Resources Controlled By function.

Legacy is the term, which signifies that a resource is assigned to the ISA Bus and provides for non-PnP ISA add-on cards. PCI / ISA PnP signifies that a resource is assigned to the PCI Bus or provides for ISA PnP add-on cards and peripherals.

The Choices: Disabled (default), Enabled

Resources Controlled By

By Choosing “Auto” the system BIOS will detect the system resources and automatically assign the relative IRQ and DMA channel for each peripheral.

By Choosing “Manual”, the user will need to assign IRQ & DMA for add-on cards. Be sure that there are no IRQ/DMA and I/O port conflicts.

The Choices: Auto (ESCD) (default), Manual

IRQ Resources

When resources are controlled manually, assign each system interrupt a type, depending on the type of device using the interrupt

PCI/ VGA Palette Snoop

Choose Disabled or Enabled. Some graphic controllers which are not VGA compatible take the output from a VGA controller and map it to their display as a way to provide boot information and VGA compatibility.

However, the color information coming from the VGA controller is drawn from the palette table inside the VGA controller to generate the proper colors, and the graphic controller needs to know what is in the palette of the VGA controller. To do this, the non-VGA graphic controller watches for the Write access to the VGA palette and registers the snoop data. In PCI based systems, where the VGA controller is on the PCI bus and a non-VGA graphic controller is on an ISA bus, the Write Access to the palette will not show up on the ISA bus if the PCI VGA controller responds to the Write.

In this case, the PCI VGA controller should not respond to the Write, it should only snoop the data and permit the access to be forwarded to the ISA bus. The non-VGA ISA graphic controller can then snoop the data on the ISA bus. Unless you have the above situation, you should disable this option.

Disabled (default)	Disables the function
Enabled	Enables the function

Assign IRQ For VGA

Lets the user choose which IRQ to assign for the VGA.

The Choices: Enabled (default),Disabled

Assign IRQ For USB

Lets the user choose which IRQ to assign for USB.

The Choices: Enabled (default),Disabled

2.8 PC Health Status

■ Figure 8. PC Health Status

CMOS Setup Utility-Copyright (C) 1984-2000 Award Software
PC Health Status

CPU FAN Speed	0 RPM	Item Help
System FAN Speed	0 RPM	
Vcore	2.04V	
2.5V	2.51V	
3.3V	3.39V	Menu Level ▶
5V	5.07V	
12V	12.12V	

↑↓▶◀ : Move Enter : Select +/-/PU/PD:Value F10:Save ESC: Exit F1:General Help
F5:Previous Values F6:Fail-Safe Defaults F7: Optimized Defaults

CPU FAN Speed

These fields display the current speed of up to CPU and System fans, if your computer contains a monitoring system.

System FAN Speed

These fields display the current speed of up to CPU and System fans, if your computer contains a monitoring system.

Vcore/2.5V/3.3V/5V/12V

Detect the system's voltage status automatically.

2.9 Frequency / Voltage Control

■ Figure 9. Frequency / Voltage Control

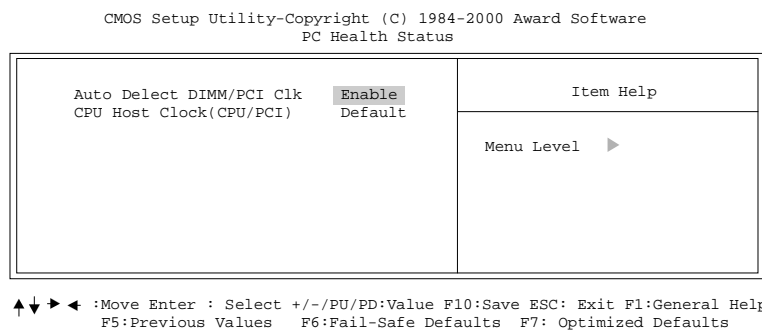

Auto Detect DIMM/PCI CLK

This item allows you to enable/disable auto Detect DIMM/PCI Clock.

The Choices: Enabled(default), Disabled

CPU Host Clock(CPU/PCI)

This item allows you select CPU Host/PCI Clock.

The Choices: Default (default), 133/ 33 Mhz (+-0.5 Spd),
133 Mhz (-0.5 Spd), 138/35 Mhz (Spd off),
147/37 Mhz (Spd off)

3. Software Setup

NOTE: The mark * means it can be installed directly from CD by using CD Installation Utility (i.e. START.EXE).

3.1 Software List

Category	Description	Platform	Location in CD
VIA Service Pack* (4 In 1)	VIA 4 In 1 driver includes (VIA Registry (ACPI) Driver /VIA AGP VxD driver /VIA ATAPI Vendor Support Driver /VIA PCI IRQ Miniport Driver) four system drivers to improve the performance and maintain the stability of system using VIA chipset.	Windows 95 / 98 / NT 4.0 ME/2000	\Mb_drv\ Service
Trident display drivers	Install the drivers to enable the Trident Video Device.	WIN9X/NT4.0 WIN2000/ME	\VIDEO
VIA Hardware Monitor *	VIA Hardware Monitor is a self-diagnostic system for PC.	Windows 95/98 NT4.0/2000/ ME	\Mb_drv\ Sysdiag
HighPoint XStore Pro *	Install the drivers to support Ultra DMA mode Hard Drive.	Windows 95/98	\Mb_drv\XStore
VIA AC97 Audio*	Install the driver to enable the VIA AC97 Audio Device	DOS, Windows 95/98/NT4.0/ WIN2000/ME	\Audio\VIA
Creative SB PCI128 Audio	Install the driver to enable the VIA AC97 Audio Device	Windows 95/98/ME/2000 /NT 4.0	\Audio\Creative
Award Flash Utility	Used for updating BIOS.	DOS	\Flash
Microsoft DirectX*	Microsoft DirectX runtime library	Windows 95/98	\DirectX

3.2 Software Installation

We provide an installation wizard, Driver CD Installation Utility (START.EXE), located in the root of Driver CD to let users install some common used drivers conveniently.

➤ **The drivers can be installed from CD by using CD Installation Utility:**

You can simply put Driver CD into CD-ROM drive and the Installation Utility will autorun or you can run the Driver CD Installation Utility directly by using mouse cursor to click the proper option on the page. Utility will invoke other applications to complete the rest of installation.

➤ **The drivers CAN NOT be installed directly from CD by using CD Installation Utility:**

Please read the README.TXT located in the root directory on Multimedia CD to get drivers' location and then refer to the INSTALL.TXT or README.TXT files located in each driver directory on the Driver CD to install drivers.

3.3 Using Software

- In general, you can get more detailed information in the on-line help or readme for the softwares.
- **Using VIA Hardware Monitor**
After the utility is installed, you can follow the sequence, **Start** → **Program** → **VIA HM** → **VIA Hardware Monitor**, to launch the monitor application.

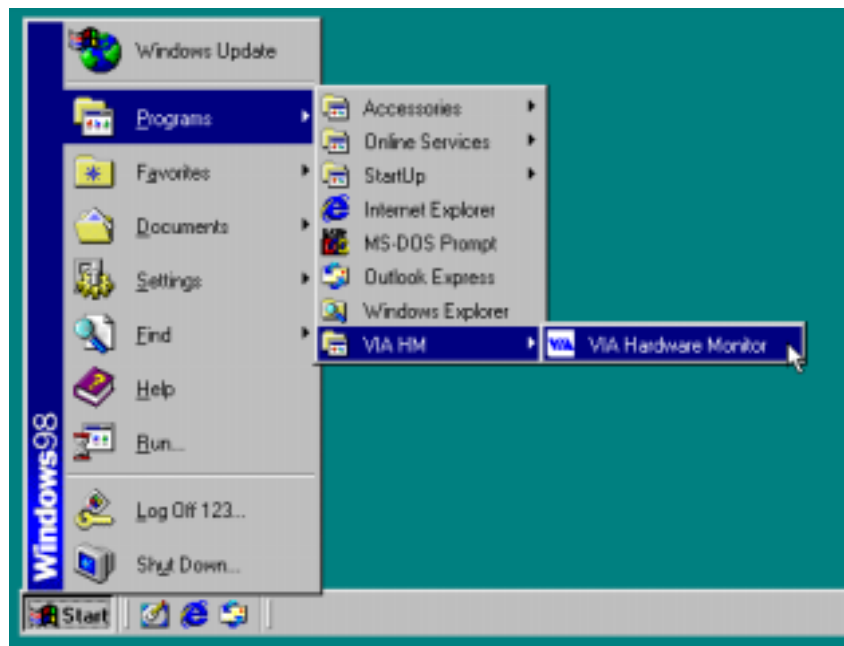

The following figure is the main panel of VIA Hardware Monitor. In the panel, you can get some real-time and important information -- Voltage, Fan speed, and temperature, for example. If there is an abnormal situation, you can resolve it immediately.

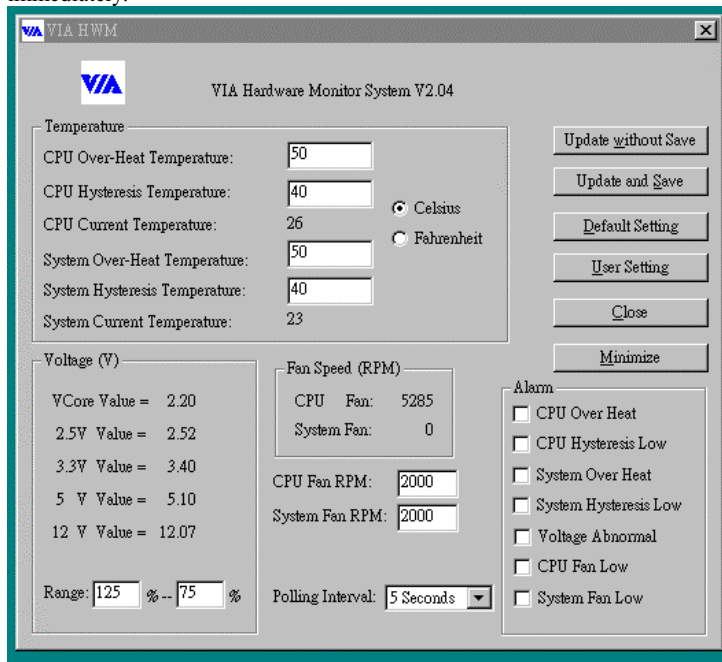

4. Trouble Shooting

PROBLEM

No power to the system at all. Power light does not illuminate, fan inside power supply does not turn on. Indicator light on keyboard does not turn on.

PROBABLE CAUSE	DIAGNOSIS	SOLUTION
Power cable is unplugged.	Visually inspect power cable	Make sure power cable is securely plugged in.
Defective power cable.	Visually inspect the cable, try another cable.	Replace cable.
Power supply failure.	Power cable and wall socket are OK, but system is still dead.	Contact technical support.
Faulty wall outlet; circuit Breaker or fuse blown.	Plug in device known to work in socket and test.	Use different socket, repair outlet, reset circuit breaker or replace fuse.

PROBLEM

System inoperative. Keyboard lights are on, power indicator lights are lit, hard drive is spinning.

PROBABLE CAUSE	DIAGNOSIS	SOLUTION
Memory DIMM is partially dislodged from the slot on the motherboard.	Turn off computer. Take cover off system unit. Check the DIMM to ensure it is securely seated in the slot.	Using even pressure on both ends of the DIMM, press down firmly until the module snaps into place.

PROBLEM

System does not boot from hard disk drive, can be booted from CD-ROM drive.

PROBABLE CAUSE	DIAGNOSIS	SOLUTION
Connector between hard drive and system board unplugged.	When attempting to run the FDISK utility you get a message, INVALID DRIVE SPECIFICATION.	Check cable running from disk to disk controller board. Make sure both ends are securely plugged in; check the drive type in the standard CMOS setup (see HARD DISK section of this manual).
Damaged hard disk or disk controller.	Format hard disk; if unable to do so the hard disk may be defective.	Contact technical support.
Hard disk directory or FAT is scrambled.	Run the FDISK program, format the hard drive (see HARD DRIVE section of manual). Copy data that was backed up onto hard drive.	Backing up the hard drive is extremely important. All hard disk are capable of breaking down at any time.

PROBLEM

System only boots from CD-ROM. Hard disk can be read and applications can be used but booting from hard disk is impossible.

PROBABLE CAUSE	DIAGNOSIS	SOLUTION
Hard disk boot program has been destroyed.	A number of causes could be behind this.	Back up data and applications files. Reformat the hard drive . Re-install applications and data using backup disks.

PROBLEM

Error message reading “SECTOR NOT FOUND” or other error messages not allowing certain data to be retrieved.

PROBABLE CAUSE	DIAGNOSIS	SOLUTION
A number of causes could be behind this.	Use a file by file backup instead of an image backup to backup the hard disk.	Back up any salvageable data. Then low level format, partition, and high level format the hard drive . Re-install all saved data when completed.

PROBLEM

Screen message says “Invalid Configuration” or “CMOS Failure.”

PROBABLE CAUSE	DIAGNOSIS	SOLUTION
Incorrect information entered into the configuration (setup) program.	Check the configuration program. Replace any incorrect information.	Review system’s equipment . Make sure correct information is in setup.

PROBLEM

Screen is blank.

PROBABLE CAUSE	DIAGNOSIS	SOLUTION
No power to monitor.		Check the power connectors to monitor and to system. Make sure monitor is connected to display card.
Monitor not connected to computer.		See instructions above.

PROBLEM

PROBABLE CAUSE	DIAGNOSIS	SOLUTION
Memory problem.		Reboot computer. Reinstall memory, make sure that all memory modules are installed in correct sockets.
Computer virus.		Use anti-virus programs to detect and clean viruses.

PROBLEM

Screen goes blank periodically.

PROBABLE CAUSE	DIAGNOSIS	SOLUTION
Screen saver is enabled.		Disable screen saver.

PROBLEM

Keyboard failure.

PROBABLE CAUSE	DIAGNOSIS	SOLUTION
Keyboard is disconnected.		Reconnect keyboard. Check keys again, if no improvement replace keyboard.

PROBLEM

No color on screen.

PROBABLE CAUSE	DIAGNOSIS	SOLUTION
Faulty Monitor.		If possible, connect monitor to another system. If no color replace monitor.
CMOS incorrectly set up.		Call technical support.

PROBLEM

C: drive failure.

PROBABLE CAUSE	DIAGNOSIS	SOLUTION
Hard drive cable not connected properly.		Check hard drive cable.

PROBLEM

Cannot boot system after installing second hard drive.

PROBABLE CAUSE	DIAGNOSIS	SOLUTION
Master/slave jumpers not set correctly.		Set master/slave jumpers correctly.
Hard drives not compatible / different manufacturers.		Run SETUP program and select correct drive types. Call drive manufacturers for compatibility with other drives.

PROBLEM

Missing operating system on hard drive.

PROBABLE CAUSE	DIAGNOSIS	SOLUTION
CMOS setup has been changed.		Run setup and select correct drive type.

PROBLEM

Certain keys do not function.

PROBABLE CAUSE	DIAGNOSIS	SOLUTION
Keys jammed or defective.		Replace keyboard.

PROBLEM

Keyboard is locked, no keys function.

PROBABLE CAUSE	DIAGNOSIS	SOLUTION
Keyboard is locked.		Unlock keyboard.

11/03/2000
MADE IN TAIWAN
R.O.C.