

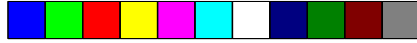

C586HX

Rev. BF0+
System Board
User's Manual





FCC Statement on Class B

This equipment has been tested and found to comply with the limits for a Class B digital device, pursuant to Part 15 of the FCC rules. These limits are designed to provide reasonable protection against harmful interference when the equipment is operated in a residential installation. This equipment generates, uses and can radiate radio frequency energy and, if not installed and used in accordance with the instruction manual, may cause harmful interference to radio communications. However, there is no guarantee that interference will not occur in a particular installation. If this equipment does cause harmful interference to radio or television reception, which can be determined by turning the equipment off and on, the user is encouraged to try to correct the interference by one or more of the following measures:

- Reorient or relocate the receiving antenna.
- Increase the separation between the equipment and the receiver.
- Connect the equipment into an outlet on a circuit different from that to which the receiver is connected.
- Consult the dealer or an experienced radio TV technician for help.

Notice:

1. The changes or modifications not expressly approved by the party responsible for compliance could void the user's authority to operate the equipment.
2. Shielded interface cables must be used in order to comply with the emission limits.

The manufacturer makes no warranties with respect to this documentation and disclaims any implied warranties of merchantability, quality, or fitness for any particular purpose. The information in this document is subject to change without notice. The manufacturer reserves the right to make revisions to this publication and to make changes to any and/or all parts of its content, at any time, without obligation to notify any person or entity of such changes. Further, the manufacturer assumes no responsibility for any errors that may appear in this document.



Table of Contents

Chapter 1: Introduction	5
Features and Specifications	6
Package Checklist	8
Chapter 2: Hardware Installation	9
Preparing the Area	9
Handling the System Board	9
Installing the System Board	10
Board Layout	12
System Memory	13
Installing a SIM Module	14
Cache Memory	14
Installing the Cache Module	15
CPU Installation	16
Jumper Settings for Various CPUs	16
Installing Upgrade CPUs	24
Installing Fan/Heatsink for Cyrix CPUs	26
Jumper Settings for Password Clear	28
Jumper Settings for Display	28
Built-in Ports	29
Serial Ports	29
PS/2 Mouse Port	30
Parallel Port	30
Floppy Disk Drive Controller	30
IDE Hard Disk Interface	31
Installing Expansion Cards	33
Chapter 3: Software Installation	34
Award BIOS CMOS Setup Utility	34
Standard CMOS Setup	35
BIOS Features Setup	40
Chipset Features Setup	46
Power Management Setup	48
PCI Configuration Setup	51
Load BIOS Defaults	52
Load Setup Defaults	52
PnP Configuration Setup	52
I/O Configuration Setup	53



Supervisor Password	55
User Password	56
IDE HDD Auto Detection	56
Save & Exit Setup	59
Exit Without Saving	59
System Error Report	60
IDE Device Drivers	62

Chapter 4: Troubleshooting Checklist	63
---	-----------

Appendix A: Types of SIM Modules	64
Appendix B: Memory and I/O Maps	65
Appendix C: PCI I/O Pin Assignments	67
Appendix D: ISA I/O Pin Assignments	68
Appendix E: System Overview	69
Appendix F: Connector Pin Assignments	71





Chapter 1 Introduction

The C586HX, equipped with a 321-pin Zero Insertion Force (ZIF) CPU socket, is a fast Pentium processor system board supporting Intel Pentium CPUs running at 75MHz, 90MHz, 100MHz, 120MHz, 133MHz, 150MHz, 166MHz and 200MHz frequencies. The C586HX also supports Cyrix P120+/P133+/P150+/P166+ and AMD-K5 PR75 75MHz CPUs.

The C586HX uses the Intel 82430HX chipset. It supports Error Checking and Correction (ECC) that performs single bit error correction and parity check for multi-bit error detection.

The C586HX can support 8MB to 256MB of system memory using EDO or fast page mode x32 or x36 DRAM. This system board also supports pipeline burst SRAM and provides easy cache upgrade using 256KB cache module.

The C586HX design is based on the Peripheral Component Interconnect (PCI) local bus and Industry Standard Architecture (ISA) standards. It is equipped with 3 dedicated PCI slots, 3 dedicated 16-bit ISA slots and 1 shared PCI/ISA slot.

The C586HX board has two bus master PCI IDE connectors. Bus mastering reduces CPU use during disk transfer. This system board is also equipped with two NS16C550A-compatible serial ports, an SPP/ECP/EPP parallel port, a floppy disk drive controller, one PS/2 mouse port, one PS/2 or AT keyboard connector and one IrDA header for wireless interface.



Features and Specifications

Processor

- Intel Pentium™ 75/90/100/120/133/150/166/200MHz
- Future Pentium™ OverDrive processor
- Cyrix P120+/P133+/P150+/P166+
- AMD-K5 PR75 75MHz

Chipset

- Intel 82430HX PCiset

Cache Memory

- Supports 256KB or 512KB pipeline burst, direct map write-back cache
- One 160-pin cache module slot
- 256KB onboard: upgradeable with a 256KB cache module for a maximum of 512KB cache

System Memory

- 8MB to 256MB onboard memory
- Four 72-pin SIMM sockets
- Uses EDO or fast page mode x32 or x36 DRAM, 60 or 70ns, 5V
- ECC and parity check supported (using x36 DRAM)

BIOS

- Award BIOS, Windows 95 Plug and Play compatible
- Flash EPROM for easy BIOS upgrades

Energy Efficient Design

- System power management supported
- CPU stopped clock control
- Hardware supports SMI green mode
- Microsoft/Intel APM 1.1 compliant
- External power management switch supported

PCI IDE Interface

- PIO Mode 3 and Mode 4 Enhanced IDE (data transfer rate up to 16.6MB/sec.)
- DMA Mode 2 Bus Master IDE (data transfer rate up to 22.2MB/sec.)



- Bus mastering reduces CPU utilization during disk transfer
- ATAPI IDE CD-ROM supported

Integrated I/O

- SMC super I/O controller
- Two NS16C550A-compatible high speed UARTs
- One SPP/ECP/EPP parallel port
- Supports 360KB, 720KB, 1.2MB, 1.44MB, and 2.88MB floppy drives
- One IrDA TX/RX header
- Two Universal Serial Bus connectors supported in future revision

CPU Socket

- 321-pin ZIF socket (Intel Socket 7)
- Supports future low-voltage (2.5V) CPUs

Connectors

- 2 serial ports
- 1 parallel port
- 2 IDE connectors
- 1 floppy connector
- 1 PS/2 mouse port
- 1 PS/2 or AT keyboard connector

Expansion Slots

- 3 dedicated PCI slots
- 3 dedicated 16-bit ISA slots
- 1 shared PCI/ISA slot

PCB

- 4 layers, Baby AT form factor
- 25cm (9.84") x 22cm (8.66")



Package Checklist

The C586HX package contains the following items:

- The C586HX system board
- The C586HX user's manual
- One 40-pin IDE hard disk cable
- One 34-pin floppy disk drive cable
- One 25-pin printer port cable for chassis mounting
- One card-edge bracket for mounting the printer port cable
- One card-edge bracket with serial and mouse port cables
- One IDE driver diskette
- Cache module (optional)

If any of these items are missing or damaged, please contact your dealer or sales representative for assistance.





Chapter 2 Hardware Installation

This chapter summarizes the steps to install the C586HX system board into your system unit. It also includes a description of the area in which you must work and directions for memory installation. Before installing the system board, obtain the memory you plan to install. Please refer to the information on page 13 for the number and type of SIM modules needed for the amount of memory you require.

Preparing the Area

Before unpacking the system board, make sure the location you have selected is relatively free of dust and static electricity. Excessive exposure to dust, static electricity, direct sunlight, excessive humidity, extreme cold, and water can damage the operational capabilities of your system board. Avoid placing the unit on surfaces such as carpeted floors. These areas attract static electricity which can damage circuits on your system board.

Make sure the power source has a properly grounded, three-pronged socket. It is essential that the power connection be properly grounded for correct functioning of your system board. For further protection, we recommend that you use a surge suppressor. This will protect the system board from damage that may result from a power surge on the electrical line.

Move items that generate magnetic fields away from your system board since magnetic fields can also damage your system board. Once you have selected the ideal location, unpack the C586HX system board carefully.

Handling the System Board

It is quite easy to inadvertently damage your system board even before installing it in your system unit. Static electrical discharge can damage computer components without causing any signs of physical damage. You must take extra care in handling the system board to ensure against electrostatic build-up.



Static Electricity Precautions

1. To prevent electrostatic build-up, leave the board in its anti-static bag until you are ready to install it.
2. Wear an antistatic wrist strap.
3. Do all preparation work on a static-free surface with the system board components facing up.
4. Hold the system board only by its edges. Be careful not to touch any of the components, contacts or connections, especially gold contacts, on the board.
5. Avoid touching the pins or contacts on all modules and connectors. Hold modules and connectors by their ends.

Warning:

Electrostatic discharge (ESD) can damage your processor, disk drives, add-in boards, and other components. Perform the upgrade instruction procedures described at an ESD workstation only. If such a station is not available, you can provide some ESD protection by wearing an anti-static wrist strap and attaching it to a metal part of the system chassis. If a wrist strap is unavailable, establish and maintain contact with the system chassis throughout any procedures requiring ESD protection.

Installing the System Board

If you are installing the C586HX system board, the following outlines the basic installation steps. Before installing the system board into your system unit, you should prepare the tools you will need.

You will need:

- One medium size, flat-bladed screwdriver
- One medium Phillips screwdriver
- One needle-nosed pliers
- One nutdriver

1. Unlock your system unit. Turn off the power and disconnect all power cords and cables.



2. Remove the system unit cover. Refer to the manufacturer's instructions if necessary.
3. Detach all connectors from the old system board and remove expansion cards seated in any of the expansion slots.
4. Loosen the screws holding the original system board and remove the board from the system. Save the screws.
5. Remove the C586HX from its original packing box. Be careful to avoid touching all connectors and pins on the board. Please refer to the handling instructions on pages 9-10 for proper handling techniques.
6. Insert the SIMMs into the SIMM banks on the C586HX. The quantity and location of the SIMMs depends on the memory configuration and type of modules you intend to use.
7. Insert the cache module, if any, into the cache module slot on the C586HX. Refer to the Cache Memory section on page 14 for upgrading your cache memory.
8. Install the CPU. Be sure pin 1 of the CPU is aligned with pin 1 of the socket.
9. Set the corresponding jumpers.
10. Install the prepared C586HX system board into the case and replace the screws.
11. Reinstall all cards and connectors and replace the system unit cover. Reconnect all power cords and cables.

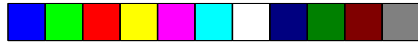

Board Layout

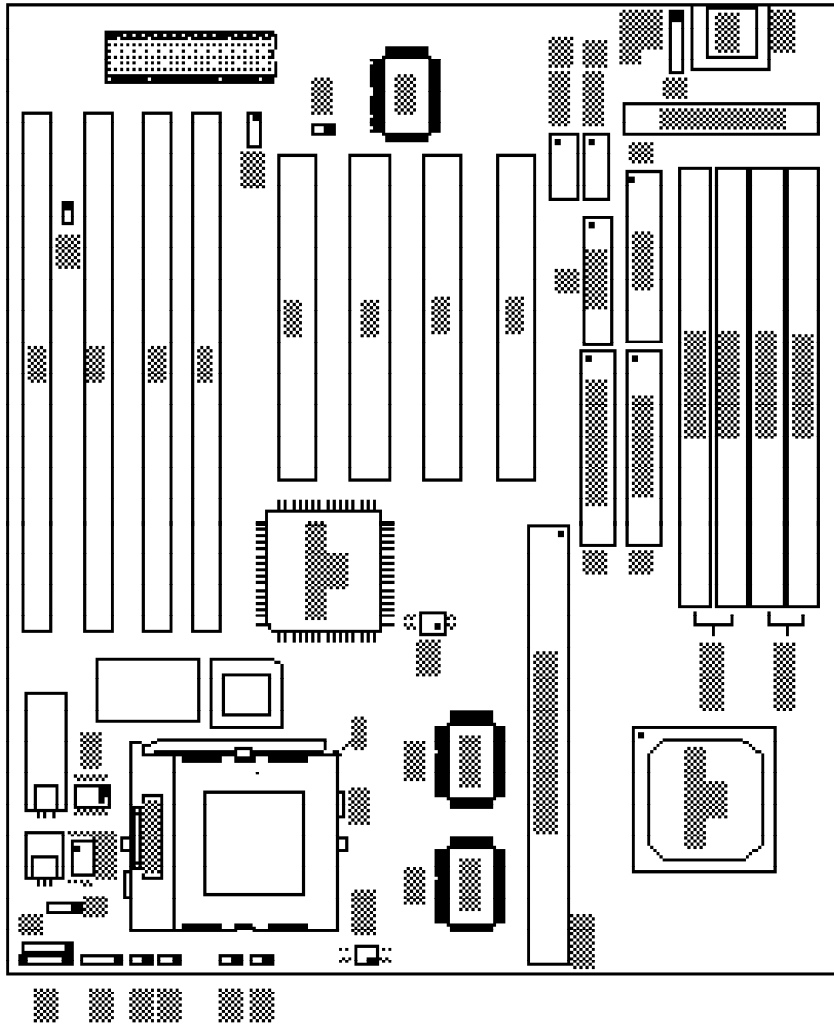

“■” square denotes pin 1
PBSRAM = Pipeline Burst SRAM

System Memory

The SIMM (Single In-line Memory Module) sockets are divided into two banks on the system board, Bank 0 and Bank 1. Each bank consists of 2 SIMM sockets.

You will need either 2 or 4 pieces of SIM modules, depending on the amount of memory you intend to install. Make sure you insert the same type of SIMMs in one bank. You can install SIMMs in either of the banks, Bank 0 or Bank 1, but you must populate a bank first before going to the next bank.

The C586HX system board can support 8MB to 256MB of memory using 1MBx36, 2MBx36, 4MBx36, 8MBx36, or 16MBx36 72-pin SIMMs. The table below shows the supported SIM modules and their corresponding memory sizes.

SIMMs	Memory Size
1MBx36	4MB
2MBx36	8MB
4MBx36	16MB
8MBx36	32MB
16MBx36	64MB

Examples:

If you are installing 8MB of memory, you must insert two 1MBx36 SIMMs in Bank 0 or Bank 1.

If you are installing 256MB of memory, you must insert four 16MBx36 SIMMs in Bank 0 and Bank 1.

If you are installing 24MB of memory, you must insert two 1MBx36 SIMMs in Bank 0 and two 2MBx36 SIMMs in Bank 1. You may also install it vice versa by inserting two 1MBx36 SIMMs in Bank 1 and two 2MBx36 SIMMs in Bank 0.

Installing a SIM Module

A SIM module simply snaps into a socket on the system board. Pin 1 of the SIM module must correspond with Pin 1 of the socket.

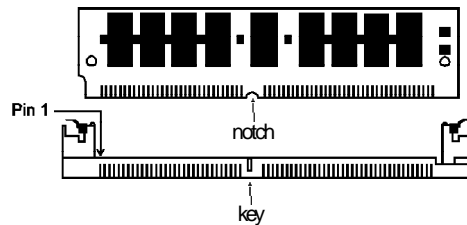

1. Position the SIMM above the socket with the “notch” in the module aligned with the “key” on the socket.
2. Seat the module at a 45° angle into the bank. Make sure it is completely seated. Tilt the module upright until it locks in place in the socket.

Cache Memory

The C586HX system board can support 256KB or 512KB pipeline burst, direct map write-back cache SRAM. Your system board come with 256KB cache mounted at locations U22 and U23 of the system board. The 160-pin cache module slot lets you upgrade your cache memory to 512KB by installing a 256KB cache module in the cache module slot. Please refer to page 12 for the locations of the cache module slot (SSM1), U22 and U23.

Note:

You do not need to set any jumpers or modify the Award BIOS Setup utility when you install the cache module.



Warning:

We highly recommend that you use the T2BSM32-256 cache module. If you are using a cache module other than the one recommended above, make sure your cache module meets the Intel COAST 2.x specification. Severe damage might occur on the cache module or system board if you insert modules other than those specified above.

Installing the Cache Module

Locate the 160-pin cache module slot on the system board (SSM1). See page 12 for the location. Position the cache module above the slot. Make sure pin 1 of the cache module is aligned with pin 1 of the slot. Carefully slide the module into the slot. Press firmly on the top of it to seat it properly.

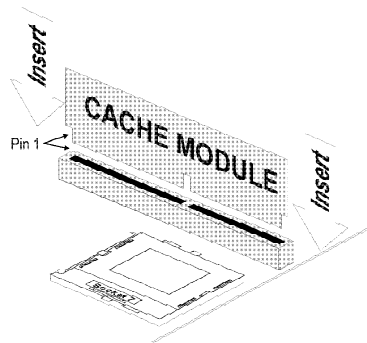

Note:

With the cache module installed in the cache module slot, the components on the solder side of the add-in card in PCI Slot 4 must not protrude more than 5mm.

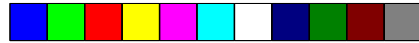

CPU Installation

The C586HX allows for easy installation of CPUs. Make sure all jumpers are set correctly before applying power or you may damage the CPU or system board. Use a needle-nosed plier to move the jumpers as necessary. Please see the jumper settings on the following pages.

Jumper Settings for Various CPUs

Jumpers JP6, JP7 and JP12

Intel 75MHz CPU: External Speed: 50MHz
Frequency Ratio: 1.5x

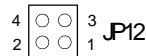
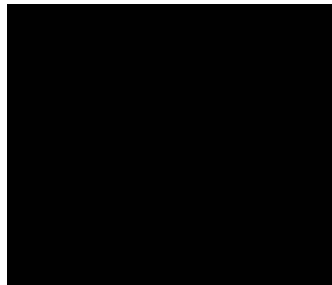
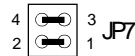

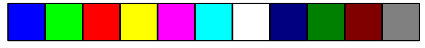

Intel 90MHz CPU: External Speed: 60MHz
Frequency Ratio: 1.5x

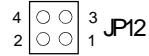
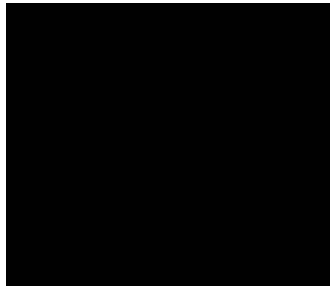
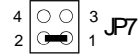

Intel 100MHz CPU: External Speed: 66MHz
Frequency Ratio: 1.5x

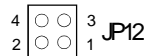
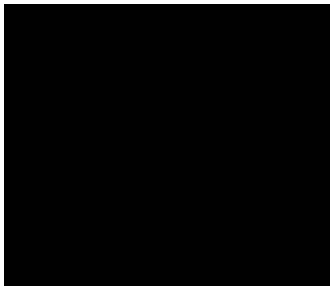
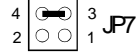

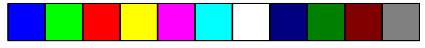

Intel 120MHz CPU: External Speed: 60MHz
Frequency Ratio: 2x

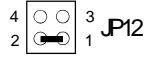
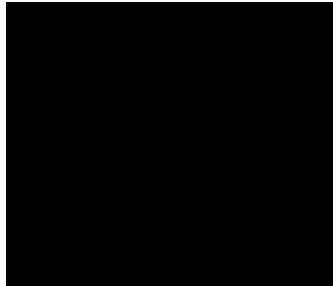
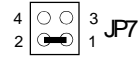

Intel 133MHz CPU: External Speed: 66MHz
Frequency Ratio: 2x

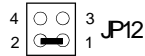
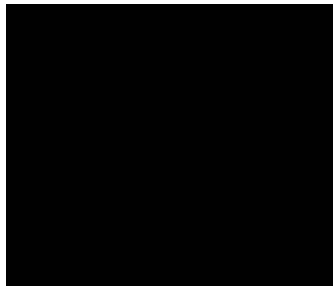
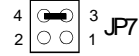

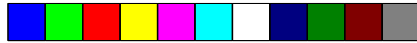

Intel 150MHz CPU: External Speed: 60MHz
Frequency Ratio: 2.5x

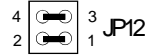
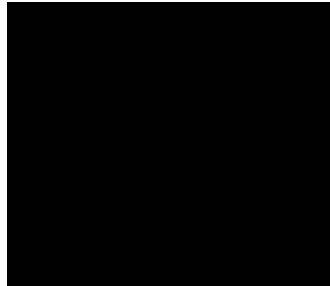
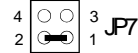

Intel 166MHz CPU: External Speed: 66MHz
Frequency Ratio: 2.5x

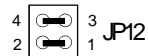
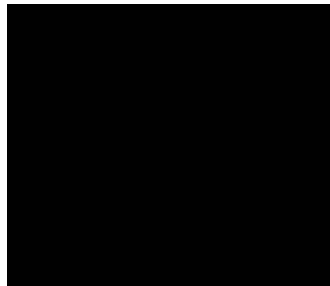
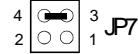

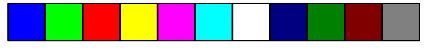

Intel 200MHz CPUs: External Speed: 66MHz
Frequency Ratio: 3x

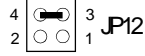
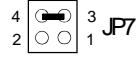

Cyrix P120+ CPU: External Speed: 50MHz
Frequency Ratio: 2x

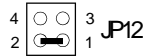
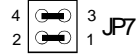

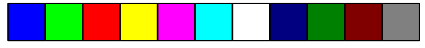

Cyrix P133+ CPU: External Speed: 55MHz
Frequency Ratio: 2x

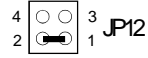
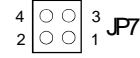

Cyrix P150+ CPU: External Speed: 60MHz
Frequency Ratio: 2x

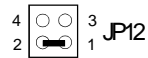
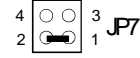

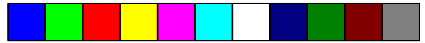

Cyrix P166+ CPU: External Speed: 66MHz
Frequency Ratio: 2x

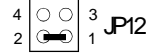
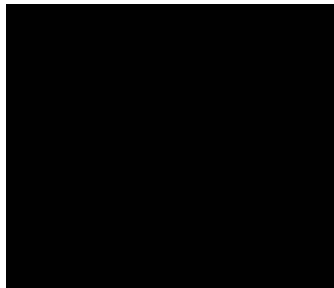
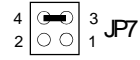

AMD-K5 PR75 75MHz CPU: External Speed: 50MHz
Frequency Ratio: 1.5x

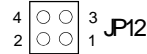
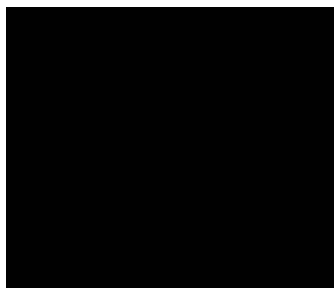
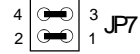



Jumpers JP9 and JP10 CPU Voltage

3.3V CPUs
(Default)

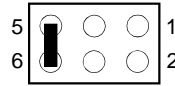

JP9: 5-6 On

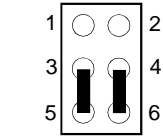

JP10: 3-5, 4-6 On

2.5V CPUs

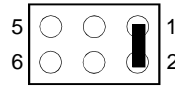

JP9: 1-2 On

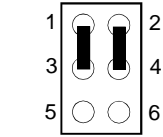

JP10: 1-3, 2-4 On



Installing Upgrade CPUs

The C586HX is equipped with a 321-pin Zero Insertion Force (ZIF) socket at location U27 of the system board. Refer to page 12 for the location of the ZIF socket. This socket is designed for easy removal of an old CPU and easy insertion of an upgrade CPU. The socket allows you to carefully place the new CPU into its position. If you need to apply excessive force to insert the CPU, you are not installing the CPU correctly.

Warning:

Open the socket only if you are actually installing a CPU. The warranty on the original CPU will be voided if the S/N seal is broken.

Before proceeding with the upgrade, take note of the following. The microprocessor and heat sink may be hot if the system has been running. To avoid the possibility of a burn, power the system off and let the processor and heat sink cool for 15 minutes.

The 321-pin ZIF socket consists of five rows of pin holes on each side. To prevent improper CPU installation, the ZIF socket has a Plug/Keying mechanism. Several holes in the socket are plugged so that the CPU will go in only one way. If you cannot easily insert the CPU, verify that pin 1 of the CPU is aligned with pin 1 of the socket.

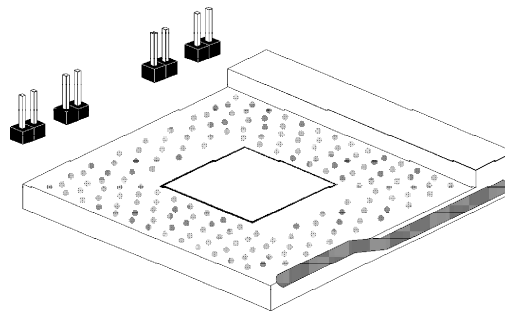

Zero Insertion Force (ZIF) Socket



To install an upgrade CPU, do the following.

1. Make sure the handle on the side of the ZIF socket is up. To raise the handle, push it down, slightly pull it out to the side, then raise it as far as it will go. It may be necessary to initially apply a small amount of sideways force to free the handle from its retaining “tab”. Once clear of the “tab”, the handle will open relatively easily. The top plate will slide back. Do not use screwdrivers or other tools to open the socket, or you may damage the system or socket.

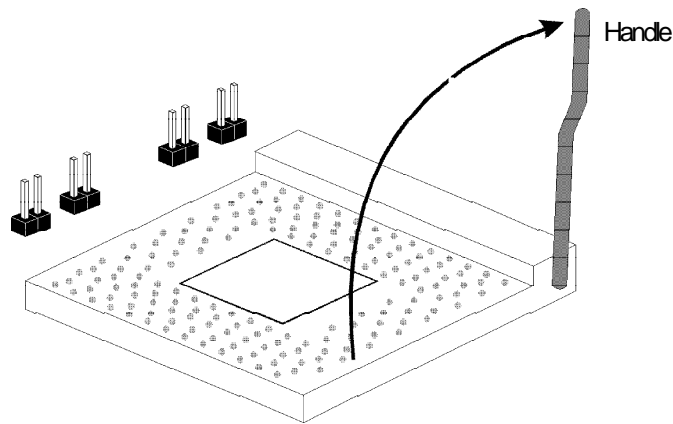

Lifting the Handle

2. Once the lever is completely up, remove the old CPU carefully by lifting it straight out of the socket. You are now ready to insert the new CPU.

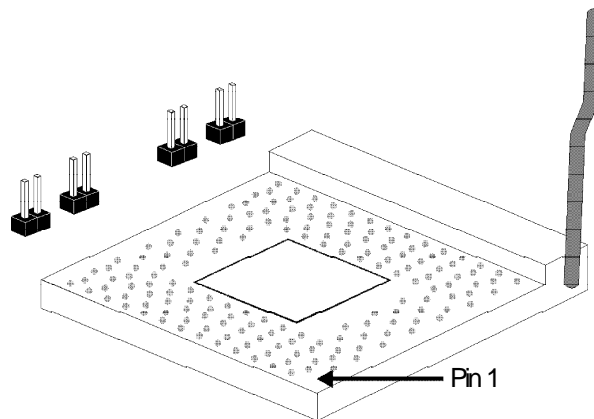

3. Position the CPU above the ZIF socket. Make sure pin 1 of the CPU is aligned with pin 1 of the socket. Lower the chip until the pins are inserted properly in their corresponding holes. Remember that very little force is needed to install the CPU. If the CPU is not easily inserted, verify whether or not pin 1 of the CPU is aligned with pin 1 of the socket. Applying too much pressure can damage the CPU or the socket.

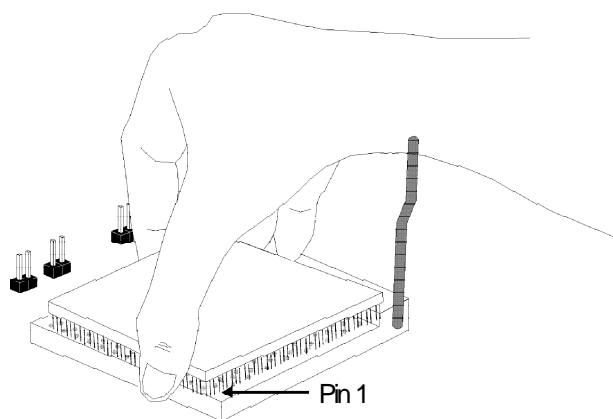

Positioning the CPU Above the ZIF Socket

4. Push the handle down until the handle locks into place. The top plate will slide forward. You will feel some resistance as the pressure starts to secure the CPU in the socket. This is normal and will not damage the CPU. However, if the handle is not completely closed, damage to the CPU and/or system board may result.

Installing Fan/Heatsink for Cyrix CPUs

The C586HX system board supports Cyrix P120+, P133+, P150+ and P166+ CPUs. These CPUs consume 7.5A of electric current. If you use a Cyrix CPU, you should choose a fan/heatsink which is made for Cyrix processors. Position the fan/heatsink on the CPU such that the air from the side of the fan will flow across the heat regulators on the system board. See the illustration on the next page.

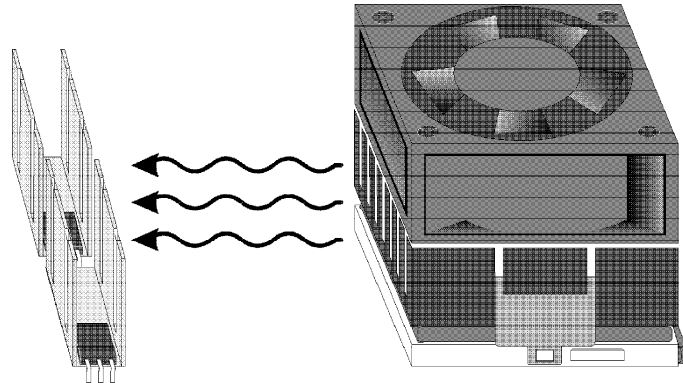

Clearance Requirements

Your CPU comes with a heatsink mounted on top. To maintain proper airflow once the upgrade CPU is installed on the system board, the CPU and heatsink require certain space clearances.

The clearance above the CPU's fan/heat sink must be at least 0.4 inches. The clearance on at least 3 of 4 sides of the processor must be at least 0.2 inches. The cables (for floppy drive, hard drive, CD-ROM, etc.) must be routed clear of the CPU and its airspace.

Fan Exhaust

The CPU must be kept cool by using a fan with heatsink. The temperature of the air entering the fan/heatsink cannot exceed 45°C (113°F). The ambient or room temperature must be below 37°C (99°F).

In order to provide proper airflow to the CPU, all movable obstructions (power supply cables, cards, floppy disk cables) must be clear of the CPU fan/heatsink component in accordance with the space clearance discussed in the Clearance Requirements section of this manual.

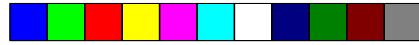

Jumper Settings for Password Clear

Jumper JP3 Password Clear

If you set a password in the "Password Setting" option and forget your password, power off your system and set Jumper JP3 to On to clear the password stored in your CMOS. Now power on your system. After your system has detected the floppy or hard drive, turn it off again and set JP3 to Off.



Off: Normal
(Default)



On: Password Clear

Jumper Settings for Display

Jumper JP4 Display Type Select

Jumper JP4 sets the display adapter to color or mono. This jumper must match the type of display adapter installed. If you change your video adapter, make sure this jumper is changed accordingly.

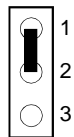

1-2 On: Color
(Default)

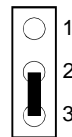

2-3 On: Mono

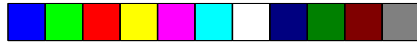

Built-in Ports

The C586HX system board is equipped with two serial ports, one parallel printer port, one FDD connector, two IDE hard disk shrouded headers and one PS/2 mouse connector. Refer to page 12 for the locations of the built-in connectors and pin 1 of those connectors.

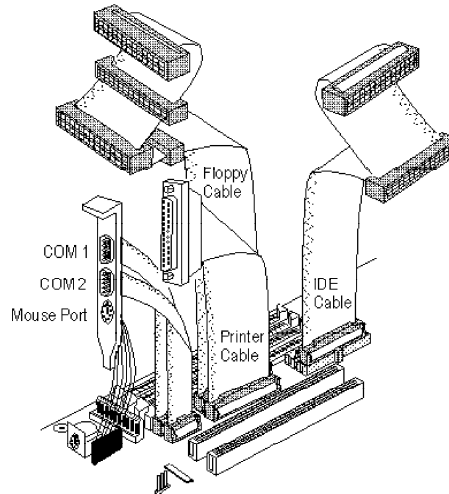

Serial Ports

The built-in serial ports are RS-232C asynchronous communication ports with 16C550A-compatible UARTs that can be used with modems, serial printers, remote display terminals, and other serial devices. They use the following system I/O addresses:

Port Configuration	COM 1	COM 2	COM 3	COM 4
Serial Port 1	3F8h*	2F8h	3E8h	2E8h
Serial Port 2	3F8h	2F8h*	3E8h	2E8h

* Default

Connecting the Serial Ports

Two 9-pin serial port cables are provided with the system board. They are mounted on a card-edge bracket along with the PS/2 mouse cable. The upper serial port cable should be used for the COM 1 primary serial port; connect it to connector J2 on the system board. The lower



serial port cable should be used for the COM 2 secondary serial port; connect it to connector J3 on the system board. Make sure the colored stripes on the ribbon cables are aligned with pin 1 of connectors J2 and J3. Mount the card-edge bracket to the system chassis.

PS/2 Mouse Port

The PS/2 mouse port is a 6-pin connector on the system board. Attach the 6-pin mouse port cable, which is mounted on the card-edge bracket, to connector J1. Make sure the brown wire on the PS/2 mouse connector is aligned with pin 1 of connector J1. Mount the card-edge bracket to the system chassis.

Parallel Port

The C586HX system board has a standard connector for interfacing your PC to a parallel printer. The parallel port on your system board can be set to any of the following system I/O addresses:

I/O Address: 3BC-3BE Hex
378-37A Hex (default)
278-27A Hex

Connecting the Parallel Printer Port

Attach the DB-25S printer port cable to connector J5 on the C586HX system board. Make sure the colored stripe on the ribbon cable aligns with pin 1 of connector J5. Use a small nutdriver to mount the cable into a DB-25 cutout in the system chassis.

You may also attach the printer port cable to the card-edge bracket which came with the system board package. After attaching the printer port cable to the card-edge bracket, mount the bracket to the system chassis.

Floppy Disk Drive Controller

The C586HX system board has a built-in floppy disk controller that supports two standard floppy disk drives. You can install any 360KB, 720KB, 1.2MB, 1.44MB, or 2.88MB floppy disk drives.



Connecting the Floppy Disk Cable

1. Install the 34-pin header connector into the floppy disk connector (J4) on the system board. The colored edge of the ribbon should be aligned with pin 1 of connector J4.
2. Install the other 34-pin header connector(s) into the disk drive(s). Align the colored edge of the daisy chained ribbon cable with pin 1 of the drive edge connector(s). The end-most connector should be attached to the drive you want to designate as Drive A.

IDE Hard Disk Interface

The C586HX system board is equipped with two PCI IDE shrouded headers that will interface up to four Enhanced IDE (Integrated Drive Electronics) hard disk drives.

Note:

Only Enhanced IDE hard drives or ATAPI CD-ROMs can be connected to the IDE interface.

Connecting the IDE Hard Disk Interface

To prevent improper IDE cable installation, each PCI IDE shrouded header has a keying mechanism. The 40-pin connector on the IDE cable can be placed into the header only if pin 1 of the connector is aligned with pin 1 of the header.

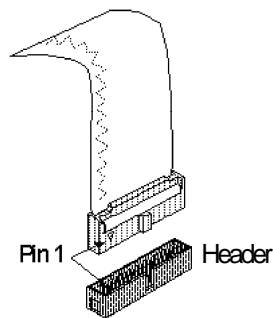

**Note:**

The IDE cable with a standard 40-pin connector (without the keying mechanism) can be installed in the PCI IDE shrouded header. Be extremely careful to match the colored edge of the ribbon with pin 1 of the header.

Connecting the Hard Disk Cable

1. Connect the cable to the system board. If you are connecting two hard drives, install the 40-pin connector of the IDE cable into the primary IDE shrouded header (connector J6). If you are adding a third or fourth IDE device, install the 40-pin connector of the other IDE cable into the secondary IDE shrouded header (connector J7).
2. Connect the cable to the devices. Install the other 40-pin header connector(s) into the device making sure to match the colored edge of the ribbon cable aligned with pin 1 of the drive edge connector(s).

Note:

Refer to your disk drive user's manual for information about selecting proper drive switch settings.

Adding a Second IDE Hard Drive

When using two IDE drives, one must be set as the master and the other as the slave. Follow the instructions provided by the drive manufacturer for setting the jumpers and/or switches on the drives.

We recommend that the Enhanced IDE hard drives be from the same manufacturer. In a few cases, drives from two different manufacturers will not function properly when used together. The problem lies in the hard drives, not the C586HX system board.

Preparing an IDE Drive for Use

IDE disk drives are already low-level formatted, with any bad-track errors entered, when shipped by the drive manufacturer. Do not attempt to do a low-level format or you may cause serious damage to the drive.



To use an IDE drive, you need to enter the drive type (this information is provided by the drive manufacturer) into the system's CMOS setup table. Then run FDISK and FORMAT provided with DOS.

The BIOS can also auto-detect the hard drive(s) installed in your system. Refer to the IDE HDD Auto Detection section for more information.

Warning:

Do not run FDISK and FORMAT programs on a drive that has already been formatted or you will lose all programs and data stored on the drive.

Installing Expansion Cards

The C586HX system board is equipped with 3 dedicated PCI slots, 3 dedicated 16-bit ISA slots and 1 shared PCI/ISA slot. All PCI slots are bus masters. You can only install one card in one or the other of the shared slots at a time; you cannot install devices in both slots.

Due to the size of the CPU with its accompanying heatsink/fan component, the length of the add-in cards in PCI slots 1 and 2 and ISA slots 1 and 2 is limited to 18cm (measured from the bracket of the card).

The length of the add-in card in PCI slot 4 is limited to 18cm only if its components protrude more than 5mm from the solder side of the card.

Refer to page 12 for the locations of the expansion slots.

Note:

The BIOS needs to be configured for the PCI add-in cards installed in the PCI slots. Refer to the "PCI Configuration Setup" presented in the "Software Installation" section of the manual.



Chapter 3 Software Installation

After you power up your system, the BIOS message appears on your screen and the memory count begins.

After the memory test, the following message will appear on the screen:

Press DEL to enter setup

If the message disappears before you respond, restart your system or press the “Reset” button on the front of your computer. You may also restart the system by pressing the <Ctrl> <Alt> and keys simultaneously. If you do not press these keys at the correct time and the system does not boot, the following error message will appear:

Press Del to enter Setup

If you have set a password and selected “System” in the Security Option of the BIOS Features Setup menu, you will be prompted for the password every time the system is rebooted or any time you try to enter Setup. Type in the correct password and press <Enter>.

If you selected “Setup” in the Security Option, you will be prompted for the password only when you try to enter Setup. Refer to the “BIOS Features Setup” section for more information.

Award BIOS CMOS Setup Utility

Press <Ctrl>, <Alt> and <Esc> keys simultaneously or to enter the Setup utility. A screen similar to the one on the next page will appear.

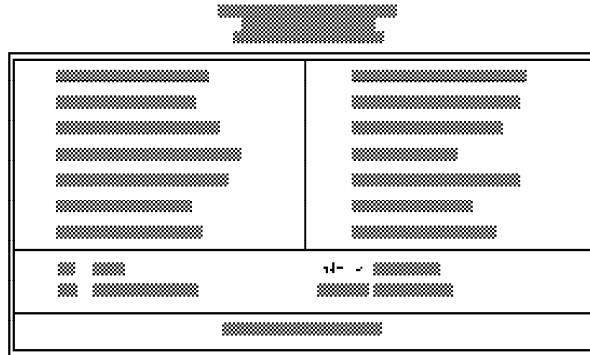

Use the arrow keys to highlight the option you want and press <Enter>. The following describes each of these options.

Note:

The settings of the BIOS setup screens on the following pages are for reference only. These settings vary according to your system's configuration and should not be referred to as the standard default setting.

Standard CMOS Setup

Use the arrow keys to highlight "Standard CMOS Setup" and press <Enter>. A screen similar to the one below will appear.

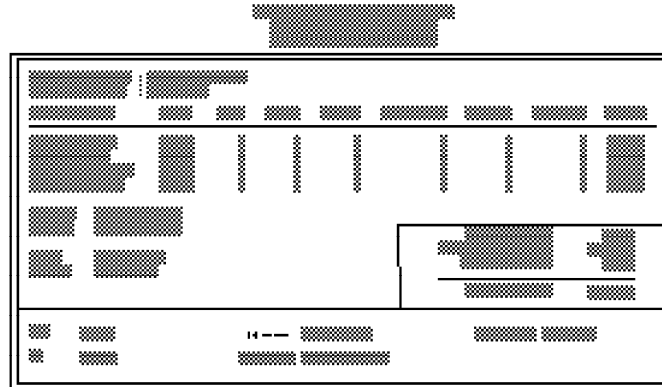



Date

The date format is <day>, <month>, <date>, <year>.

Day	Displays a day, from Sunday to Saturday
Month	Displays the month, January through December
Date	Displays the date, from 1 to 31
Year	Displays the year, from 1900 through 2099

Time

The time format is <hour>, <minute>, <second>. The time is calculated based on the 24-hour military-time clock. For example, 1 p.m. is 13:00:00.

Hour	Displays hours from 00 to 23
Minute	Displays minutes from 00 to 59
Second	Displays seconds from 00 to 59

Primary Master, Primary Slave, Secondary Master and Secondary Slave

These categories allow you to enter the appropriate specifications for the type of hard disk drive(s) installed in your system. There are 45 predefined types and 4 user definable types for Enhanced IDE BIOS. Type 1 to Type 45 are predefined. Type user is user-definable.

Press <PgUp> or <PgDn> to select a numbered hard disk type or type the number and press <Enter>. The hard disk will not work properly if you enter improper information for this category. You can use Type "User" to define your own drive type manually.

If you select Type "User", you will need to know the information listed below. Enter the information and press <Enter>. This information should be included in the documentation from your hard disk vendor or the system manufacturer.

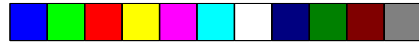

If the controller of the HDD interface is ESDI, you must select "Type 1".

If the controller of the HDD interface is SCSI, you must select "None".

If you select Type "Auto", the BIOS will auto-detect the HDD & CD-ROM drive at the POST stage and show the IDE for the HDD & CD-ROM drive.

Type	Drive type
Cyls	Number of cylinders
Heads	Number of heads
Precomp	Write precomp
Landzone	Landing zone
Sectors	Number of sectors
Mode	Mode type

If a hard disk has not been installed, select None and press <Enter>.

Drive A and Drive B

This category identifies the types of floppy disk drive installed. The following are the options for drives A and B.

None	No floppy drive is installed
360K, 5.25 in.	5-1/4 inch PC-type standard drive; 360 kilobyte capacity
1.2M, 5.25 in.	5-1/4 inch AT-type high-density drive; 1.2 megabyte capacity
720K, 3.5 in.	3-1/2 inch double-sided drive; 720 kilobyte capacity
1.44M, 3.5 in.	3-1/2 inch double-sided drive; 1.44 megabyte capacity
2.88M, 3.5 in.	3-1/2 inch double-sided drive; 2.88 megabyte capacity

Note:

Choosing an incorrect type might cause your system to format the floppy disk improperly.



Video

This category selects the type of video adapter used for the primary system monitor. Although secondary monitors are supported, you do not have to select the type in Setup. The default setting is EGA/VGA (BIOS default, Setup default).

EGA/VGA	Enhanced Graphics Adapter/Video Graphics Array. For EGA, VGA, SEGA, SVGA and PGA monitor adapters.
CGA 40	Color Graphics Adapter. Power up in 40-column mode.
CGA 80	Color Graphics Adapter. Power up in 80-column mode.
Mono	Monochrome adapter. Includes high resolution monochrome adapters.

Halt On

This category determines whether the system will stop if an error is detected during power up. The default setting is All Errors (BIOS default, Setup default).

No Errors	The system boot will not stop for any errors detected.
All Errors	The system boot will stop whenever the BIOS detects a non-fatal error.
All, But Keyboard	The system boot will not stop for a keyboard error; it will stop for all other errors.
All, But Diskette	The system boot will not stop for a disk error; it will stop for all other errors.
All, But Disk/Key	The system boot will not stop for a disk or keyboard error; it will stop for all other errors.



Memory

The base memory size, extended memory size and the other memory size cannot be altered; your computer automatically detects and displays them.

Base Memory: The POST will determine the amount of base (or conventional) memory installed in the system. The value of the base memory is typically 512K for systems with 512K memory installed on the motherboard, or 640K for systems with 640K or more memory installed on the motherboard.

Extended Memory: The BIOS determines how much extended memory is present during the POST. This is the amount of memory located above 1MB in the CPU's memory address map.

Other Memory: This refers to the memory located in the 640K to 1024K address space. This is the memory that can be used for different applications. DOS uses this area to load device drivers in an effort to keep as much base memory free for application programs. The BIOS is the most frequent user of this RAM area since this is where it shadows RAM



BIOS Features Setup

Use the arrow keys to highlight “BIOS Features Setup” and press <Enter>, a screen similar to the one below will appear.

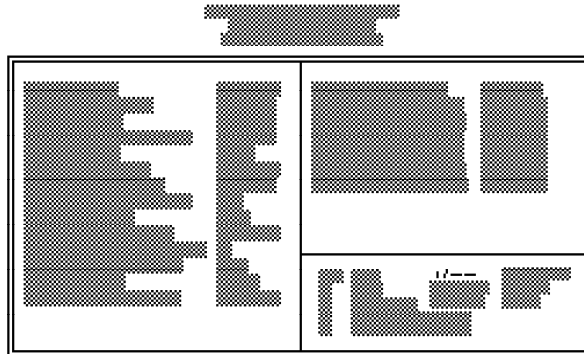

Virus Warning

This category protects the boot sector and partition table of your hard disk drive. When this item is enabled, the Award BIOS will monitor the boot sector and partition table of the hard disk drive. If an attempt is made, the BIOS will halt the system and the following error message will appear.

!WARNING!
Disk boot sector is to be modified
Type “Y” to accept write or “N” to abort write
Award Software, Inc.

Afterwards, if necessary, you will be able to run an anti-virus program to locate and remove the problem before any damage is done.





Many disk diagnostic programs which attempt to access the boot sector table will cause the warning message to appear. If you are running such a program, we recommend that you first disable this category. Also, disable this category if you are installing or running certain operating systems like Windows 95 or the operating system may not install nor work.

Enabled	BIOS issues a warning when any program or virus sends a Disk Format command or attempts to write to the boot sector of the hard disk drive.
Disabled	No warning message will appear when the hard disk drive is accessed.

CPU Internal Cache and External Cache

These categories speed up the memory access. However, it depends on the CPU/chipset design. The default value is enabled. Enable the External Cache for better performance.

Enabled	Enables the internal/external cache.
Disabled	Disables the internal/external cache.

Quick Power On Self Test

This category speeds up Power On Self Test (POST) after you power on your system. If it is set to Enabled, the BIOS will shorten or skip some check items during POST.

Enabled	Enables quick POST.
Disabled	Normal POST.



Boot Sequence

This category determines which drive to search first for the disk operating system (i.e. DOS). The default is A, C.

A, C	The system will first search for a floppy drive and then a hard disk drive.
C, A	The system will first search for a hard disk drive and then a floppy drive.
CDROM, C, A	The system will first search for a CD-ROM drive, then a hard disk drive and then a floppy drive.
C, CDROM, A	The system will first search for a hard disk drive, then a CD-ROM drive, and then a floppy drive.

Swap Floppy Drive

Enabled	When this option is enabled and the system is booting from the floppy drive, this option causes the system to boot from drive B instead of drive A.
Disabled	When this option is disabled and the system is booting from the floppy drive, the system will boot from drive A.

Boot Up Floppy Seek

During POST, the BIOS will determine if the floppy disk drive installed is 40 or 80 tracks. 360K type is 40 tracks while 720K, 1.2M, 1.44M and 2.88M are all 80 tracks.

Enabled	The BIOS will check whether the floppy disk drive installed is 40 or 80 tracks. Note that the BIOS cannot tell from 720K, 1.2M, 1.44M or 2.88M drive type as they are all 80 tracks.
Disabled	The BIOS will not search for the type of floppy disk drive by track number. Note that there will not be any warning message if the drive installed is 360KB.



Boot Up NumLock Status

This allows you to determine the default state of the numeric keypad. By default, the system boots up with NumLock on.

On	The function of the numeric keypad is the number keys.
Off	The function of the numeric keypad is the arrow keys.

Gate A20 Option

This entry allows you to select how the gate A20 is handled. The gate A20 is a device used to address memory above 1 Mbytes. Initially, the gate A20 was handled via a pin on the keyboard. Today, while keyboards still provide this support, it is more common, and much faster, for the system chipset to provide support for gate A20.

Normal	Keyboard
Fast	Chipset

Typematic Rate Setting

When disabled, continually holding down a key on your keyboard will cause the BIOS to report that the key is down. When the typematic rate is enabled, the BIOS will not only report that the key is down, but will first wait for a moment, and, if the key is still down, it will begin to report that the key has been depressed repeatedly. For example, you would use such a feature to accelerate cursor movements with the arrow keys.

Enabled	Enable the typematic rate.
Disabled	Disable the typematic rate.



Typematic Rate (Chars/Sec)

When the typematic rate is enabled, this selection allows you to select the rate at which the keys are accelerated.

6	6 characters per second
8	8 characters per second
10	10 characters per second
12	12 characters per second
15	15 characters per second
20	20 characters per second
24	24 characters per second
30	30 characters per second

Typematic Delay (Msec)

When the typematic rate is enabled, this selection allows you to select the delay between when the key was first depressed and when the acceleration begins.

250	250 msec
500	500 msec
750	750 msec
1000	1000 msec

Security Option

This category allows you to limit access to your system and Setup, or just to setup.

System	The system will not boot and access to Setup will be denied if the correct password is not entered at the prompt.
Setup	The system will boot, but access to Setup will be denied if the correct password is not entered at the prompt.





PCI/VGA Palette Snoop

This is used to select whether to allow the MPEG ISA/VESA VGA cards to work with PCI/VGA or not.

Enabled	PCI/VGA working with MPEG ISA/VESA VGA Card.
Disabled	PCI/VGA not working with MPEG ISA/VESA VGA Card.

Video BIOS Shadow

Determines whether video BIOS will be copied to RAM. Video Shadow will increase the video speed.

Enabled	Video shadow is enabled.
Disabled	Video shadow is disabled.

C8000-CBFFF Shadow to DC000-DFFFF Shadow

These categories determine whether option ROMs will be copied to RAM

Enabled	Optional shadow is enabled.
Disabled	Optional shadow is disabled.



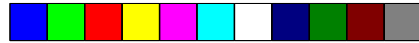

Chipset Features Setup

The C586HX uses the Intel 82430HX chipset. This section allows you to configure the system based on the specific features of the chipset. This chipset manages bus speeds and access to system memory resources, such as DRAM and the external cache. It also coordinates communications between the conventional ISA bus and the PCI bus. These items should not be altered unless necessary. The default settings have been chosen because they provide the best operating conditions for your system. The only time you might consider making any changes would be if you discovered that data was being lost while using your system.



Auto Configuration

Enabled	The pre-defined items will be displayed, but cannot be altered.
Disabled	This allows you to set the pre-defined items.

IDE HDD Block Mode

Enabled	The IDE HDD uses the block mode. The system BIOS will check the hard disk drive for the maximum block size the system can transfer. The block size will depend on the type of hard disk drive.
Disabled	The IDE HDD uses the standard mode.



IDE Primary Master/Slave PIO and IDE Secondary Master/Slave PIO

Your system supports five modes, 0 (default) to 4, which primarily differ in timing. When Auto is selected, the BIOS will select the best available mode.

Auto	The BIOS will automatically set the system according to your hard disk drive's timing.
0-4	You can select a mode that matches your hard disk drive's timing.

On-Chip Primary PCI IDE and On-Chip Secondary PCI IDE

These categories allow you to enable or disable the primary and secondary IDE controller. The default is Enabled. Select Disabled if you want to add a higher performance or specialized controller.

PCI Slot IDE 2nd Channel

This allows you to designate an IDE controller board inserted into one of the PCI slots as your secondary IDE controller.

Enabled	External IDE controller designated as the secondary controller.
Disabled	No IDE controller occupying a PCI slot.



Power Management Setup

Use the arrow keys to highlight “Power Management Setup” and press <Enter>. A screen similar to the one below will appear.



Power Management

This category allows you to select the type (or degree) of power saving and is directly related to the following modes: Doze Mode, Standby Mode, and Suspend Mode.

Disable (default)	No power management. Disables all four modes.
Min. Power Saving	Minimum power management. Doze Mode = 1 hr., Standby Mode = 1 hr., and Suspend Mode = 1 hr.
Max. Power Saving	Maximum power management. Doze Mode = 1 min., Standby Mode = 1 min., and Suspend Mode = 1 min.
User Defined	Allows you to set each mode individually. When enabled, each option ranges from 1 min. to 1 hr.





PM Control by APM

Yes	An Advanced Power Management device will be activated to enhance the Max. Power Saving mode and stop the CPU's internal clock.
Nb	Default.

Video Off Method

This determines the manner in which the monitor is blanked.

VH SYNC+ Blank	This selection will cause the system to turn off the vertical and horizontal synchronization ports and write blanks to the video buffer.
Blank Screen	This option only writes blanks to the video buffer.
DPMS	Initialize display power management signaling.

Doze Mode

This Green PC power saving function is user configurable only when the Power Management category is set to User Defined. It is used to define the idle time that elapses before the system enters the Doze mode. When enabled and after the set time of system inactivity, the CPU clock will run at slower speed while all other devices still operate at full speed.

Standby Mode

This Green PC power saving function is user configurable only when the Power Management category is set to User Defined. It is used to define the idle time that elapses before the system enters the Standby mode. When enabled and after the set time of system inactivity, the fixed disk drive and the video will be shut off while all other devices still operate at full speed.



Suspend Mode

This Green PC power saving function is user configurable only when the Power Management category is set to User Defined. It is used to define the idle time that elapses before the system enters the Suspend mode. When enabled and after the set time of system inactivity, all devices except the CPU will be shut off.

HDD Power Down

This Green PC power saving function is user configurable only when the Power Management category is set to User Defined. It is used to define the continuous HDD idle time that elapses before the HDD enters the power saving mode (motor off). When enabled and after the set time of system inactivity, the hard disk drive will be powered down while all other devices remain active.

IRQ3 to IRQ15 (Wake Up Events in Doze and Standby; Power Down and Resume Events)

These are I/O events whose occurrence can prevent the system from entering a power saving mode or can awaken the system from such a mode. In effect, the system remains alert for anything which occurs to a device which is configured as On, even when the system is in a power saving mode.

When an I/O device wants to gain the attention of the operating system, it signals this by causing an IRQ to occur. When the operating system is ready to respond to the request, it interrupts itself and performs the service. When set to On, the activity will neither prevent the system from going into a power saving mode nor awaken it.

PCI Configuration Setup

Use the arrow keys to highlight "PCI Configuration Setup" and press <Enter>; a screen similar to the one below will appear.

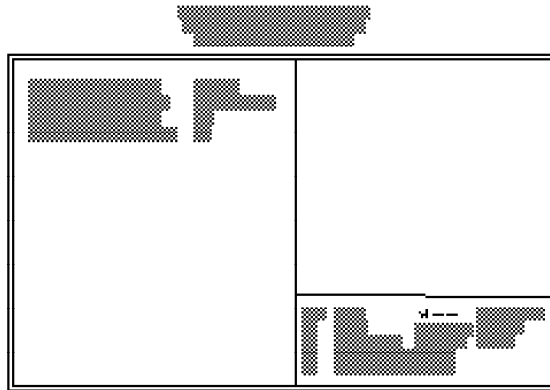

PCI IRQ Activated By

This category is used to set the method by which the PCI bus recognizes that an IRQ service is being requested by a device. Under all circumstances, you should retain the default configuration unless otherwise needed.

PCI IDE IRQ Map To

This category is used to configure your system to the type of IDE disk controller in use. By default, the BIOS assumes that your controller is an ISA device. The C586HX system board uses a PCI IDE chip allowing you to set this category to the PCI Slot # and PCI interrupt being used by your hard drives.

ISA	Default setting. (The IDE disk controller is an ISA controller).
PCI Slot 1-4	The slot that has the PCI IDE controller; that is if you are using a PCI IDE controller card.
PCI-Auto	The system will automatically determine how your IDE disk system is configured.



If this category is set to PCI Slot 1/2/3/4 or PCI-Auto, the Primary and Secondary IDE INT# categories will appear allowing you to select the PCI interrupt (A, B, C, or D) that is associated with the connected hard drives.

Load BIOS Defaults

The “Load BIOS Defaults” option loads the troubleshooting default values permanently stored in the ROM chips. These settings are not optimal and turn off all high performance features. You should use these values only if you have hardware problems. Highlight this option on the main menu and press <Enter>. The message below will appear.

Load BIOS Defaults (Y/N)? N

If you want to proceed, press <Y> and the default settings will be loaded.

Load Setup Defaults



The “Load Setup Defaults” option loads optimized settings from the BIOS ROM. Use the Setup default values as standard values for your system.



Highlight this option on the main menu and press <Enter>. The message below will appear.

Load Setup Defaults (Y/N)? N

Type <Y> and press <Enter> to load the Setup default values.

PnP Configuration Setup

Use the arrow keys to highlight “PnP Configuration Setup” and press <Enter>. A screen similar to the one on the next page will appear.



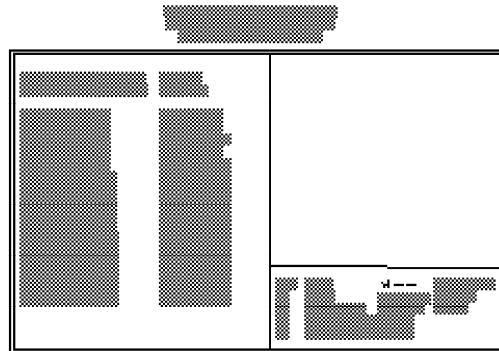

The default setting of the Resources Controlled By option is "Manual". This will allow you to set the IRQ you have assigned your add-in card to Legacy ISA or PCI/ISA PnP (Plug and Play). For non-PnP ISA cards, select Legacy ISA. For PnP ISA or PCI cards, select PCI/ISA PnP.

If the Resources Controlled By option is set to "Auto", the system will automatically detect the settings for you. IRQ 3 - IRQ 15 and DMA 0 - DMA 7 options will not be shown in the PnP Configuration Setup screen.

I/O Configuration Setup

Use the arrow keys to highlight "I/O Configuration Setup" and press <Enter>. A screen similar to the one below will appear.

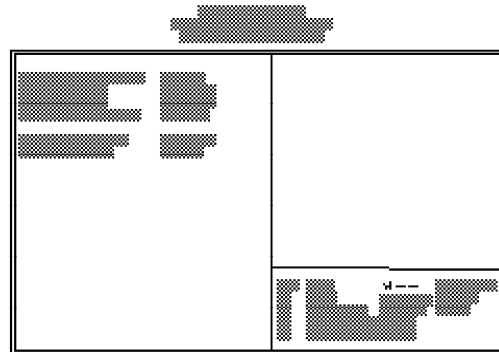

Onboard FDC Controller

Enabled	Enables the onboard floppy disk controller.
Disabled	Disables the onboard floppy disk controller.

Onboard UART 1 and Onboard UART 2

3F8/IRQ4	Selects the I/O address for the onboard serial port 1 and serial port 2. The default address for onboard UART 1 is 3F8/IRQ4. The default address for onboard UART 2 is 2F8/IRQ3.
2F8/IRQ3	
3E8/IRQ4	
2E8/IRQ3	
Disabled	Disables the onboard serial port 1 or serial port 2.

Onboard UART 2 Mode

The C586HX rev. BF0+ system board is equipped with an SMC 669 I/O chip which supports the IrDA function for wireless connectivity between your computer and peripheral devices. To use the IrDA function, follow the steps below.

1. Connect the IrDA cable, which is attached to your computer chassis, to connector J9 of the C586HX system board. Refer to page 12 for the location of connector J9.
2. Set the onboard UART 2 Mode option in the I/O Configuration Setup to the type of IrDA standard supported by your computer.

You may not use IrDA (J9) and the COM 2 serial port (J3) at the same time. If you are using the COM 2 serial port, set the onboard UART 2 Mode option to "Standard".

Standard	Uses the COM 2 serial port.
HPSIR	HP mode IrDA.
ASKIR	Sharp mode IrDA.



Onboard Parallel Port

378H/IRQ7	Selects the I/O address and IRQ for the onboard parallel port. The default is 378/IRQ7.
3BCH/IRQ7	
278H/IRQ5	
Disabled	Disables the onboard parallel port.

Parallel Port Mode

Normal	Selects the parallel port mode according to the type of printer device connected to your onboard parallel port.
EPP	
ECP	
ECP+EPP	

Supervisor Password

If you want to protect your system and setup from unauthorized entry, set a supervisor's password with the "System" option selected in the BIOS Features Setup.

If you want to protect access to setup only, but not your system, set a supervisor's password with the "Setup" option selected in the BIOS Features Setup. You will not be prompted for a password when you cold boot the system.

Use the arrow keys to highlight the "Supervisor Password" option and press <Enter>. The message below will appear.

Enter Password:

Type in the password. You are limited to eight characters. When done, the message below will appear:

Confirm Password:

You are asked to verify the password. Type in exactly the same password. If you type in a wrong password, you will be prompted to enter the correct password again.



To delete or disable the password function, highlight “Supervisor Password” and press <Enter>, instead of typing in a new password. Press the <Esc> key to return to the main menu.

If you forget your password, you should clear any previously set password by setting Jumper JP3 to On for approximately two minutes. Refer to the Jumper Settings for Password Clear on page 28 for more information.

User Password

If you want another user to have access only to your system but not to setup, set a user’s password with the “System” option selected in the BIOS Features Setup.

If you want a user to enter a password when trying to access setup, set a user’s password with the “Setup” option selected in the BIOS Features Setup. Using user’s password to enter Setup allows a user to access only the “User Password” option that appears on the main screen. Access to all other options is denied.

To set, confirm, verify, disable or delete a user’s password, follow the procedures described in the section “Supervisor Password”. If you forget your password, refer to the procedure described in the same section.

IDE HDD Auto Detection

This option detects the hard disk parameters for the hard disk drives installed in your system. Highlight this option and press <Enter>. A screen similar to the one on the next page will appear.

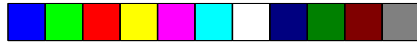

Enter your choice, and press <Enter> to accept the parameters or press <Esc> to abort. The parameters of the hard disk will be displayed in the Standard CMOS Setup.

Hard Drive Mode

The C586HX supports three HDD modes: Normal, LBA and Large. If your hard disk drive does not support LBA mode, the "LBA" option will not be displayed. If your HDD has 1024 or fewer cylinders, the "Large" option will not be displayed.

Normal Mode

The Normal mode is the generic access mode in which neither the BIOS nor the IDE controller will make any transformations during hard-drive access.

The maximum number of cylinders, heads and sectors for Normal mode are 1024, 16 and 63, respectively.

	no. Cylinders	(1024)
x	no. Heads	(16)
x	no. Sectors	(63)
x	bytes per sector	(512)

528 megabytes



If you set your HDD to Normal mode, the maximum accessible HDD will be 528 megabytes even though the physical size of the HDD may be larger.

LBA (Logical Block Addressing) Mode

The LBA mode is a HDD accessing method to overcome the 528 megabyte limitation. The number of cylinders, heads and sectors shown on the screen may not be the actual number for the HDD.

During the HDD accessing, the IDE controller will transform the logical address described by the sector, head and cylinder number into its own physical address inside the HDD.

The maximum HDD size supported by the LBA mode is 8.4 gigabytes. It is obtained by the following formula.

$$\begin{array}{r} \text{no. Cylinders} \quad (1024) \\ \times \text{ no. Heads} \quad (225) \\ \times \text{ no. Sectors} \quad (63) \\ \times \text{ bytes per sector} \quad (512) \\ \hline \end{array}$$

8.4 gigabytes

Large Mode

The Large mode is the extended HDD access mode supported by the C586HX system board. Some IDE HDDs have more than 1024 cylinders without LBA support (in some cases, you may not want the LBA mode). This system board provides another alternative to support these kinds of HDDs.

The BIOS tells the operating system that the number of cylinders is half of the actual number and that the number of heads is double the actual number. During disk access, the reverse conversion is done by the INT13h routine.

Example of Large mode:

CYLS.	HEADS	SECTORS	MODE
1120	16	59	NORMAL
560	32	59	LARGE



Maximum HDD size:

no. Cylinders	(1024)
x no. Heads	(32)
x no. Sectors	(63)
x bytes per sector	(512)

1 gigabyte

Note:

To support LBA or Large mode, address translation software is included in the Award BIOS HDD Service Routine (INT13h). If you are running an operating system that bypasses the BIOS Int13 Service Routine, LBA and Large Mode may fail.

Save & Exit Setup

When all the changes have been made, highlight “Save & Exit Setup” and press <Enter>. The message below will appear:

Save to CMOS and Exit (Y/N)? N

Type “Y” and press <Enter>. The following message will appear:

Reboot System (Y/N)? N

Type “Y” and press <Enter>. The modifications you have made will be written into the CMOS memory, and the system will reboot. You will once again see the initial diagnostics on the screen. If you wish to make additional changes to the setup, press <Ctrl>, <Alt> and <Esc> keys simultaneously or after memory testing is done.

Exit Without Saving

When you do not want to save the changes you have made, highlight “Exit Without Saving” and press <Enter>. The message below will appear:

Quit Without Saving (Y/N)? N

Type “Y” and press <Enter>. The system will reboot and you will once again see the initial diagnostics on the screen. If you wish to make any changes to the setup, press <Ctrl>, <Alt> and <Esc> keys simultaneously or after memory testing is done.



System Error Report

When the BIOS encounters an error that requires the user to correct something, either a beep code will sound or a message will be displayed in a box in the middle of the screen and the message **PRESS F1 TO CONTINUE, CTRL-ALT-ESC or DEL TO ENTER SETUP**, will be shown in the information box at the bottom. Enter Setup to correct the error.

POST Beep

There is one beep code in the BIOS. This code indicates that a video error has occurred and the BIOS cannot initialize the video screen to display any additional information. This beep code consists of a single long beep followed by two short beeps. If you get this error, contact your system board dealer or representative.

Error Messages

One or more of the following messages may be displayed if the BIOS detects an error during the POST.

DISK BOOT FAILURE, INSERT SYSTEM DISK AND PRESS ENTER

No boot device was found. Insert a system disk into Drive A and press <Enter>. If the system normally boots from the hard drive, make sure the controller is inserted correctly and all cables are properly attached. Also be sure the disk is formatted as a boot device. Reboot the system.

DISKETTE DRIVES OR TYPES MISMATCH ERROR - RUN SETUP

The type of diskette drive installed in the system is different from the CMOS definition. Run setup to reconfigure the drive type correctly.

DISPLAY SWITCH IS SET INCORRECTLY

The display switch on the system board can be set to either monochrome or color. This error indicates the switch is set to a different setting than indicated in Setup. Determine which setting is correct and either turn off the system and change the jumper or enter Setup and change the VIDEO selection.



DISPLAY TYPE HAS CHANGED SINCE LAST BOOT

Since last powering off the system, the display adapter has been changed. You must configure the system for the new display type.

ERROR ENCOUNTERED INITIALIZING HARD DRIVE

The hard drive cannot be initialized. Be sure all cables are correctly and firmly attached. Also, be sure the correct hard drive type is selected in Setup.

ERROR INITIALIZING HARD DISK CONTROLLER

The system cannot initialize the controller. Be sure the correct hard drive type is selected in Setup. Also, check to see if any jumper needs to be set correctly on the hard drive.

FLOPPY DISK CNTRLR ERROR OR NO CNTRLR PRESENT

The system cannot find or initialize the floppy drive controller. If no floppy drive is installed, be sure the Diskette Drive selection in Setup is set to NONE.

KEYBOARD ERROR OR NO KEYBOARD PRESENT

Cannot initialize the keyboard. Make sure the keyboard is attached correctly and no keys are being pressed during the boot.

If you are purposely configuring the system without a keyboard, set the error halt condition in Setup to HALT ON ALL, BUT KEYBOARD. This will cause the BIOS to ignore the missing keyboard and continue the boot.

MEMORY ADDRESS ERROR AT...

Indicates a memory address error at a specific location. You can use this location along with the memory map for your system to find and replace the bad memory chips.

MEMORY SIZE HAS CHANGED SINCE LAST BOOT

Memory has been added or removed since the last boot. Enter Setup and enter the new memory size in the memory fields.

MEMORY VERIFY ERROR AT...

Indicates an error verifying a value already written to memory. Use the location along with your system's memory map to locate the bad chip.



OFFENDING ADDRESS NOT FOUND

This message is used in conjunction with the I/O CHANNEL CHECK and RAM PARITY ERROR messages when the segment that has caused the problem cannot be isolated.

OFFENDING SEGMENT

This message is used in conjunction with the I/O CHANNEL CHECK and RAM PARITY ERROR messages when the segment that has caused the problem has been isolated.

PRESS A KEY TO REBOOT

This will be displayed at the bottom screen when an error occurs that requires a reboot. Press any key and the system will reboot.

SYSTEM HALTED, (CTRL-ALT-DEL) TO REBOOT...

Indicates the present boot attempt has been aborted and the system must be rebooted. Press and hold down the <CTRL>, ALT and keys simultaneously.

IDE Device Drivers

To install the IDE device drivers supported by the C586HX system board, please refer to the "Readme" file contained in the provided diskette.



Chapter 4 Troubleshooting Checklist

If you experience difficulty with the C586HX system board, please refer to the checklist below. If you still cannot identify the problem, please contact your dealer.

1. Check the jumper settings to ensure that the jumpers are properly set. If in doubt, refer to the "Hardware Installation" section.
2. Verify that all SIMMs are seated securely into the bank sockets.
3. Make sure the SIMMs are in the correct locations.
4. Check that all populated memory banks are filled with correctly sized SIMMs.
5. If your board fails to function, place the board on a flat surface and seat all socketed components (gently press each component into the socket).
6. If you made changes to the BIOS settings, re-enter setup and load the BIOS defaults.



Appendix A Types of Modules

The C586HX system board allows you to populate memory with 1MBx36, 2MBx36, 4MBx36, 8MBx36, and 16MBx36 SIMMs. The following modules have been tested with this board. Most untested brands will work but a few may fail to do so.

SIMM	Brand	Chip Number
1MBx36	Fujitsu	81C1000A-70
	Hyundai	HY514400A
	Toshiba	TC511000AJL
	OKI	M51440A-70
2MBx36	OKI	M511000B-70
	NEC	424400-60
	Micron	40447-60
	TI	TMS4400DJ-70
	Micron	MT4C4007-70 (EDO)
	Micron	MT4C4007-60 (EDO)
4MBx36	NEC	4218165-60 (EDO)
	Hitachi	7400AS-70
	Fujitsu	8117400-70
	Mitsubishi	422A06-70
	Hitachi	5117400AS-70
	NEC	4217400-60
NEC	4217405-70 (EDO)	



Appendix B Memory and I/O Maps

Memory Address Map

Address	Name	Function
00000000 to 0009FFFF	640KB System Board RAM	System Board Memory
000A0000 to 000BFFFF	128KB Video Display Memory	Reserved for Graphics Display Memory
000C0000 to 000E7FFF	160KB I/O Expansion ROM	Reserved for ROM on I/O Adapter Card
000E8000 to 000FFFFF	96KB ROM on the System Board	System Board BIOS
00100000 to 0FFFFFFF	Maximum Memory 256MB	System Board Memory

I/O Address Map

I/O Address	Function
0000-001F	DMA Controller 1, 8237A-5
0020-003F	Interrupt Controller 1, 8259A, Master
0040-005F	Timer, 8254-2
0060-006F	8742 (Keyboard Controller)
0070-007F	Real-time Clock, NMI (Non-maskable Interrupt) Mask
0080-009F	DMA Page Memory, 74LS612
00A0-00BF	Interrupt Controller 2, 8259A
00C0-00DF	DMA Controller 2, 8237A-5
00E8	Shadow RAM and Cache Control Bit
00F0	Clear Numeric Processor Extension Busy
00F1	Reset Numeric Processor Extension
00F8-00FF	Numeric Processor Extension
01F0-01F8	Fixed Disk
0200-0207	Game I/O
0278-027F	Parallel Printer Port 2
02F8-02FF	Serial Port 2
0300-031F	Prototype Card
0360-036F	Reserved
0378-037F	Parallel Printer Port 1
0380-038F	SDLC, Bisynchronous 2
03A0-03AF	Bisynchronous 1
03B0-03BF	Monochrome Display and Printer Adapter
03C0-03CF	Reserved
03D0-03DF	Color/Graphics Monitor Adapter
03F0-03F7	Diskette Controller
03F8-03FF	Serial Port 1

Note:

The I/O address hex 0000 to 00FF are reserved for the system board I/O. Hex 0100 to 03FF are available on the I/O channels.

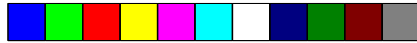

Appendix C PCI I/O Pin Assignments

Component Side	B	A	Solder Side
	-12V	-01 -	TRST#
	TCK	-02 -	+12V
	Ground	-03 -	TMS
	TDO	-04 -	TDI
	+5V	-05 -	+5V
	+5V	-06 -	INTA#
	INTB#	-07 -	INTC#
	INTD#	-08 -	+5V
	PRSNT1#	-09 -	Reserved
	Reserved	-10 -	+5V (I/O)
	PRSNT2#	-11 -	Reserved
	Ground	-12 -	Ground
	Ground	-13 -	Ground
	Reserved	-14 -	Reserved
	Ground	-15 -	RST#
	CLK	-16 -	+5V (I/O)
	Ground	-17 -	GNT#
	REQ#	-18 -	Ground
	+5V (I/O)	-19 -	Reserved
	AD[31]	-20 -	AD[30]
	AD[29]	-21 -	N. C.
	Ground	-22 -	AD[28]
	AD[27]	-23 -	AD[26]
	AD[25]	-24 -	Ground
	N. C.	-25 -	AD[24]
	C/BE[3]#	-26 -	IDSEL
	AD[23]	-27 -	N. C.
	Ground	-28 -	AD[22]
	AD[21]	-29 -	AD[20]
	AD[19]	-30 -	Ground
	N. C.	-31 -	AD[18]
	AD[17]	-32 -	AD[16]
	C/BE[2]#	-33 -	N. C.
	Ground	-34 -	FRAME#
	IRDY#	-35 -	Ground
	N. C.	-36 -	TRDY#
	DEVSEL#	-37 -	Ground
	Ground	-38 -	STOP#
	LOCK#	-39 -	N. C.
	PERR#	-40 -	SDONE
	N. C.	-41 -	SBO#
	SERR#	-42 -	Ground
	N. C.	-43 -	PAR
	C/BE[1]#	-44 -	AD[15]
	AD[14]	-45 -	N. C.
	Ground	-46 -	AD[13]
	AD[12]	-47 -	AD[11]
	AD[10]	-48 -	Ground
	Ground	-49 -	AD[09]
	AD[08]	-52 -	C/BE[0]#
	AD[07]	-53 -	N. C.
	N. C.	-54 -	AD[06]
	AD[05]	-55 -	AD[04]
	AD[03]	-56 -	Ground
	Ground	-57 -	AD[02]
	AD[01]	-58 -	AD[00]
	+5V (I/O)	-59 -	+5V (I/O)
	ACK64#	-60 -	REQ64#
	+5V	-61 -	+5V
	+5V	-62 -	+5V

Appendix D ISA I/O Pin Assignments

B		A
Gnd	- 01 -	-/OChck
ResetDiv	- 02 -	SD7
+5V	- 03 -	SD6
IRQ9	- 04 -	SD6
-5V	- 05 -	SD4
DRQ2	- 06 -	SD8
-12V	- 07 -	SD2
O/S	- 08 -	SD1
+12V	- 09 -	SD0
Gnd	- 10 -	-/OChrdy
-SEMEMW	- 11 -	AEN
-SEMEMR	- 12 -	SA19
-IOW	- 13 -	SA18
-IOR	- 14 -	SA17
-Dack3	- 15 -	SA16
-DRQ3	- 16 -	SA15
-Dack1	- 17 -	SA14
DRQ1	- 18 -	SA13
-Refresh	- 19 -	SA12
CLK	- 20 -	SA11
IRQ7	- 21 -	SA10
IRQ6	- 22 -	SA9
IRQ5	- 23 -	SA8
IRQ4	- 24 -	SA7
IRQ3	- 25 -	SA6
-Dack2	- 26 -	SA5
T/C	- 27 -	SA4
Bale	- 28 -	SA3
+5V	- 29 -	SA2
CSC	- 30 -	SA1
Gnd	- 31 -	SA0

D		C
-MemCS16	- 01 -	SBHE
-/OCS16	- 02 -	LA23
IRQ10	- 03 -	LA22
IRQ11	- 04 -	LA21
IRQ12	- 05 -	LA20
IRQ13	- 06 -	LA19
IRQ14	- 07 -	LA18
-Dack0	- 08 -	LA17
DRQ0	- 09 -	-Memr
-Dack5	- 10 -	-Memw
DRQ5	- 11 -	SD08
-Dack6	- 12 -	SD09
DRQ6	- 13 -	SD10
-Dack7	- 14 -	SD11
DRQ7	- 15 -	SD12
+5V	- 16 -	SD13
-Master	- 17 -	SD14
Gnd	- 18 -	SD15

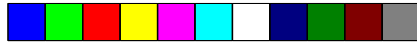

Appendix E System Overview

DMA Controller 1	DMA Controller 2
Ch0-Reserved for User	Ch4-Cascade for CTRL 1
Ch1-Reserved for User	Ch5-Reserved for User
Ch2-Diskette	Ch6-Reserved for User
Ch3-Reserved for User	Ch7-Reserved for User

Note:

DMA controller 1 supports 8-bit data transfer.

DMA controller 2 supports 16-bit data transfer.

Address Generation for DMA Channels 3 to 0

Source Address	DMA Page Memory A23 ↔ A16	DMA Controller 1 A15 ↔ A0
---------------------------	--------------------------------------	--------------------------------------

Address Generation for DMA Channels 7 to 5

Source Address	DMA Page Memory A23 ↔ A17	DMA Controller 2 A16 ↔ A1
---------------------------	--------------------------------------	--------------------------------------

Page Memory Address

I/O Port Address	Page Memory
0081H	DMA Channel 2
0082H	DMA Channel 3
0083H	DMA Channel 1
0087H	DMA Channel 0
0089H	DMA Channel 6
008AH	DMA Channel 7
008BH	DMA Channel 5

System Interrupts

Interrupt Controller 1	Interrupt Controller 2
IRQ0-Timer Output (Out 0)	IRQ9-Software Redirected to INT 0AH (IRQ2)
IRQ1-KeyBoard (Output Buffer Full)	IRQ10-Reserved
IRQ2-Interrupt from INTR2	IRQ11-Reserved
IRQ3-Serial Port 2	IRQ12-PS/2 Mouse
IRQ4-Serial Port 1	IRQ13-Coprocessor
IRQ5-Parallel Port 2 or 3 *	IRQ14-Primary Fixed Disk Controller (1F0)
IRQ6-Diskette Controller	IRQ15-Secondary Fixed Disk Controller (170)
IRQ7-Parallel Port 1 or 2 *	
IRQ8-Realtime Clock INT	

* The one on-board parallel port can be configured to either Parallel Port 1, 2 or 3. Parallel Port 1 uses I/O address 3BCh, Parallel Port 2 uses I/O address 378h, and Parallel Port 3 uses I/O address 278H.

Note:

The 16 levels of system interrupts have the following priority: IRQ0> IRQ1> IRQ8> IRQ9> IRQ10> IRQ11> IRQ12> IRQ13> IRQ14> IRQ15> IRQ3> IRQ4> IRQ5> IRQ6> IRQ7.

System Timers

Channel 0	Channel 1	Channel 2
System Timer (IRQ0)	Refresh Request Generator (15 μ s Rate Generator Period Signal)	Tone Generation for Speaker

Real-Time Clock

Address	Function	Address	Function
00	Seconds	07	Date of Month
01	Second Alarm	08	Month
02	Minutes	09	Year
03	Minute Alarm	0A	Register A
04	Hours	0B	Register B
05	Hour Alarm	0C	Register C
06	Day of Week	0D	Register D

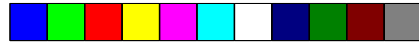

Appendix F Connector Pin Assignments

Connector J1 PS2 Mouse Connector

Pin	Function
1	Mouse Data
2	Reserved
3	Ground
4	+5V
5	Mouse Clock
6	Reserved

J2 (COM1) and J3 (COM2) COM 1 and COM 2 Serial Ports

Pin	Function
1	DCD (Data Carrier Detect)
2	RX (Receive Data)
3	TX (Transmit Data)
4	DTR (Data Terminal Ready)
5	Ground (Signal Ground)
6	DSR (Data Set Ready)
7	RTS (Request to Send)
8	CTS (Clear to Send)
9	RI (Ring Indicator)

Connector J4 Floppy Disk Drive Connector

Pin	Function	Pin	Function
1	Ground	11	Ground
2	DENSEL	12	DR1
3	Ground	13	Ground
4	Reserved	14	DR0
5	Ground	15	Ground
6	Drate0	16	MTR1
7	Ground	17	Drate1
8	Index	18	Dir
9	Ground	19	Ground
10	MTR0	20	Step

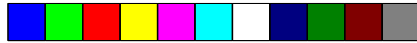

Pin	Function
21	Ground
22	Write Data
23	Ground
24	Write Gate
25	Ground
26	Track 0
27	MSEN

Pin	Function
28	Wr Protect
29	Ground
30	Read Data
31	Ground
32	Head Select
33	Ground
34	Disk Change

Connector J5
Parallel Printer Port

Pin	Function
1	-Strobe
2	Data 0
3	Data 1
4	Data 2
5	Data 3
6	Data 4
7	Data 5
8	Data 6
9	Data 7
10	-Ack
11	Busy
12	Paper Empty
13	Select

Pin	Function
14	-Autofd
15	-Error
16	-Init
17	-Sictin
18	Ground
19	Ground
20	Ground
21	Ground
22	Ground
23	Ground
24	Ground
25	Ground

Connectors J6 and J7
Primary and Secondary IDE Hard Disk Drive Connectors

Pin	Function
1	-Reset
2	Ground
3	D7
4	D8
5	D6
6	D9
7	D5
8	D10
9	D4
10	D11
11	D3
12	D12
13	D2
14	D13

Pin	Function
15	D1
16	D14
17	D0
18	D15
19	Ground
20	Reserved
21	Reserved
22	Ground
23	-IOW
24	Ground
25	-IOR
26	Ground
27	Reserved
28	BALE

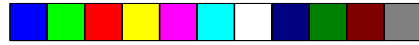

Pin	Function
29	Reserved
30	Ground
31	IRQ
32	IOCS16
33	SA1
34	Reserved
35	SA0
36	SA2
37	HCS0
38	HCS1
39	LED
40	Ground

Connector J8
Fan Connector

Pin	Function
1	Ground
2	+12V
3	Ground

Connector J9
Infrared Connector

Pin	Function
1	IRTX
2	Ground
3	IRRX
4	Reserved
5	+5V

Pin 1 of the IrDA cable must be aligned with pin 1 of connector J9.

Connector J10
Primary/Secondary IDE LED Connector

Pin	Function
1	Signal
2	+5V

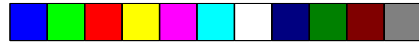

Connector J11
Green LED Connector

Pin	Function
1	Signal
2	+5V

Connector J13
Green Button Connector

Pin	Function
1	Ground
2	Signal

Connector J14
Reset Switch Connector

Pin	Function
1	Ground
2	Reset

Connector J15
Speaker Connector

Pin	Function
1	Signal
2	Reserved
3	Ground
4	+5V

Connector J16
Power LED/Keylock Connector

Pin	Function
1	LED Signal
2	Reserved
3	Ground
4	Keylock Signal
5	Ground

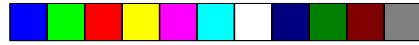

Connector CN1
PS/2 Keyboard Connector

Pin	Function
1	Keyboard Data
2	Reserved
3	Ground
4	+5V
5	Keyboard Clock
6	Reserved

Connector CN2
AT Keyboard Connector

Pin	Function
1	Keyboard Clock
2	Keyboard Data
3	Reserved
4	Ground
5	+5V

Connector PL1
Power Connector

Pin	Function
1	Power Good
2	+5V
3	+12V
4	-12V
5	Ground
6	Ground
7	Ground
8	Ground
9	-5V
10	+5V
11	+5V
12	+5V



Connector SSM1
Cache Module Slot

Pin	Function	Pin	Function
1	Ground	47	D48
2	TIO0	48	Ground
3	TIO2	49	D46
4	TIO6	50	D44
5	TIO4	51	D42
6	TIO8	52	+3.3V
7	+3.3V	53	D40
8	TWE#	54	D38
9	CADS#CAA3	55	D36
10	Ground	56	Ground
11	HBE4#	57	D34
12	HBE6#	58	D32
13	HBE0#	59	D30
14	HBE2#	60	+3.3V
15	+3.3V	61	D28
16	CCS#CAB4	62	D26
17	GWE#	63	D24
18	BWE#	64	Ground
19	Ground	65	D22
20	A3	66	D20
21	A7	67	D18
22	A5	68	+3.3V
23	A11	69	D16
24	A16	70	D14
25	+3.3V	71	D12
26	A18	72	Ground
27	Ground	73	D10
28	A12	74	D8
29	A13	75	D6
30	ADSP#	76	+3.3V
31	ECS1#(CS#)	77	D4
32	ECS2#	78	D2
33	PD1	79	D0
34	PD3	80	Ground
35	Ground	81	Ground
36	CLK1	82	TIO1
37	Ground	83	TIO7
38	D62	84	TIO5
39	+3.3V	85	TIO3
40	D60	86	TIO9
41	D58	87	+5V
42	D56	88	TIO10
43	Ground	89	CADV#CAA4
44	D54	90	Ground
45	D52	91	COE#
46	D50	92	HBE5#

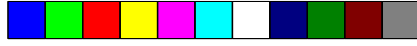

Pin	Function
93	HBE7#
94	HBE1#
95	+5V
96	HBE3#
97	CAB3
98	CALE
99	Ground
100	RSVD
101	A4
102	A6
103	A8
104	A10
105	+5V
106	A17
107	Ground
108	A9
109	A14
110	A15
111	RSVD
112	PD0
113	PD2
114	PD4
115	Ground
116	CLK0
117	Ground
118	F63
119	+5V
120	D61
121	D69
122	D57
123	Ground
124	D65
125	D53
126	D51

Pin	Function
127	D49
128	Ground
129	D47
130	D45
131	D43
132	+5V
133	D41
134	D39
135	D37
136	Ground
137	D35
138	D33
139	D31
140	+5V
141	D29
142	D27
143	D25
144	Ground
145	D23
146	D21
147	D19
148	+5V
149	D17
150	D15
151	D13
152	Ground
153	D11
154	D9
155	D7
156	+5V
157	D5
158	D3
159	D1
160	Ground