



586ITOX

Rev. BA+
System Board
User's Manual



34071113



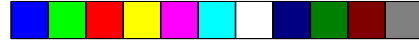

Copyright

This publication contains the information that is protected by copyright. No part of it may be reproduced in any form or by any means or used to make any transformation/adaptation without the prior written permission from the copyright holders.

This publication is provided for informational purposes only. The manufacturer makes no representations or warranties with respect to the contents or use of this manual and specifically disclaims any express or implied warranties of merchantability or fitness for any particular purpose. The user will assume the entire risk of the use or the results of the use of this document. Further, the manufacturer reserves the right to revise this publication and make changes to its contents at any time, without obligation to notify any person or entity of such revisions or changes.

All Rights Reserved.

Trademarks



Microsoft® MS-DOS®, Windows™ and Windows® 95 are registered trademarks of Microsoft Corporation. Intel and Pentium are registered trademarks of Intel Corporation. Cyrix, 6x86, 6x86L and 6x86MX are registered trademarks of Cyrix Corporation. AMD, K5 and K6 are registered trademarks of Advanced Micro Devices, Inc. IBM is a registered trademark of International Business Machine Corporation. Award is a registered trademark of Award Software, Inc. Other trademarks and registered trademarks of products appearing in this manual are the properties of their respective holders.



Caution:

Danger of explosion if battery incorrectly replaced. Replace only with the same or equivalent type recommended by the manufacturer. Dispose of used batteries according to the battery manufacturer's instructions.





FCC and DOC Statement on Class B

This equipment has been tested and found to comply with the limits for a Class B digital device, pursuant to Part 15 of the FCC rules. These limits are designed to provide reasonable protection against harmful interference when the equipment is operated in a residential installation. This equipment generates, uses and can radiate radio frequency energy and, if not installed and used in accordance with the instruction manual, may cause harmful interference to radio communications. However, there is no guarantee that interference will not occur in a particular installation. If this equipment does cause harmful interference to radio or television reception, which can be determined by turning the equipment off and on, the user is encouraged to try to correct the interference by one or more of the following measures:

- Reorient or relocate the receiving antenna.
- Increase the separation between the equipment and the receiver.
- Connect the equipment into an outlet on a circuit different from that to which the receiver is connected.
- Consult the dealer or an experienced radio TV technician for help.

Notice:

1. The changes or modifications not expressly approved by the party responsible for compliance could void the user's authority to operate the equipment.
2. Shielded interface cables must be used in order to comply with the emission limits.

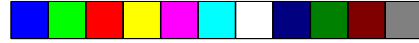

Table of Contents

Chapter 1 - Introduction

Features and Specifications.....	7
Package Checklist.....	12

Chapter 2 - Award BIOS Setup Utility

The Basic Input/Output System.....	14
Standard CMOS Setup.....	14
BIOS Features Setup.....	18
Chipset Features Setup.....	22
Power Management Setup.....	24
PNP/PCI Configuration.....	28
Load Fail-Safe Settings.....	30
Load Optimal Settings.....	30
Integrated Peripherals.....	31
Supervisor Password.....	34
User Password.....	35
IDE HDD Auto Detection.....	36
Save & Exit Setup.....	37
Exit Without Saving.....	37

Chapter 3 - Upgrade Guide

System Memory.....	39
Cache Memory.....	43
Processor Upgrade Information.....	44
Jumper Settings for Modem Ring-on.....	52
Jumper Settings for CMOS Clear.....	53
Jumper Settings for VGA.....	54
Jumper Settings for Software Power-off.....	55



Chapter 4 - Desktop Management Interface

Desktop Management Interface..... 57

Appendix A - Installation Instructions

Preparing the Area..... 61
Handling the System Board..... 61

Appendix B - Connecting Cables

Ports and Connectors..... 65

Appendix C - System Board Layout

System Board Layout..... 77

Appendix D - DIM and SIM Modules

Types of Modules..... 79

Appendix E - Watchdog Timer

Using the Watchdog Timer Function..... 82

Appendix F - Driver Installation

Driver Installation..... 84

Appendix G - Troubleshooting

Troubleshooting..... 86

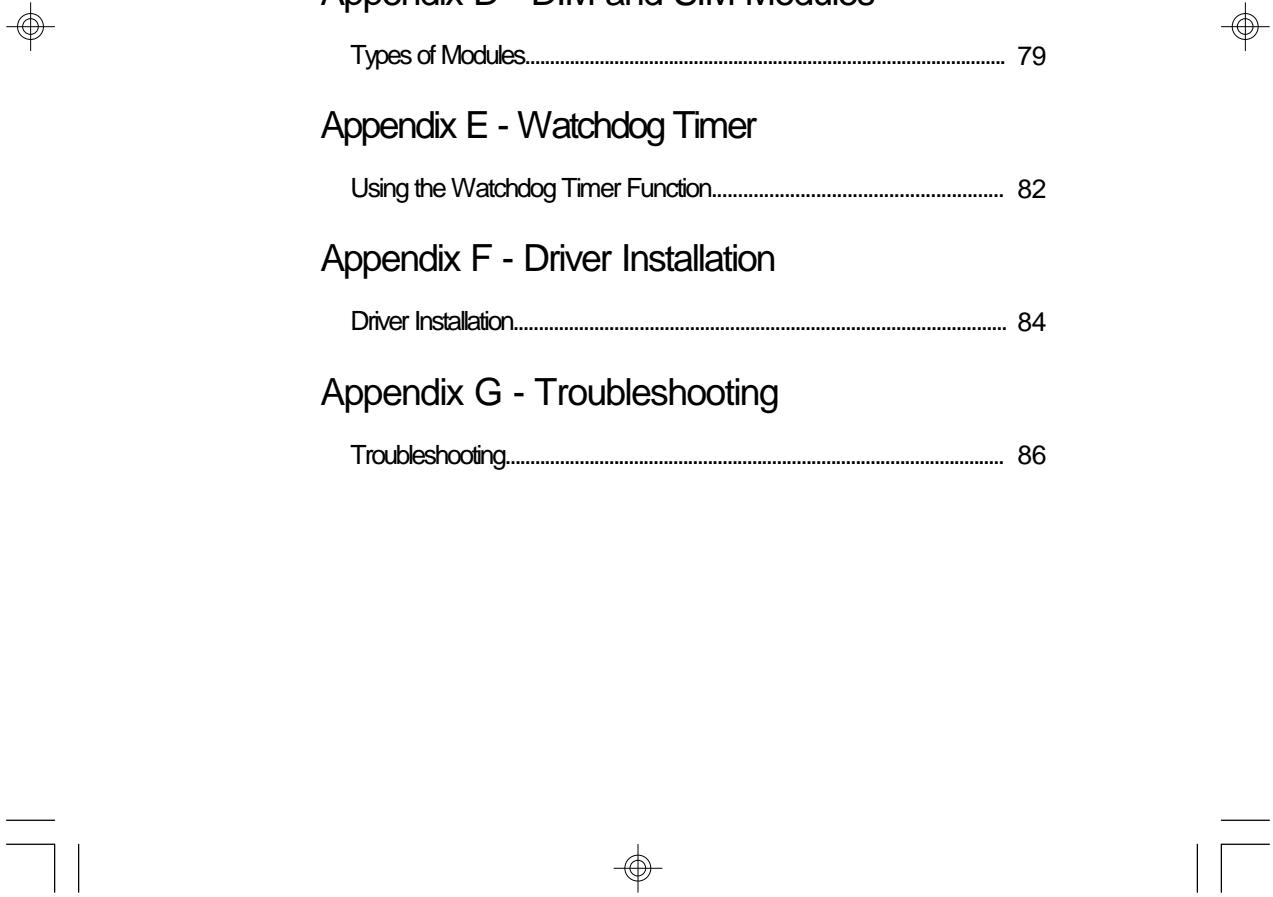

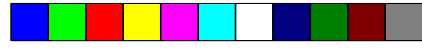

1

586ITOX System Board User's Manual

CHAPTER

1

Introduction





Features and Specifications

Processor Upgrade

The system board is equipped with a 321-pin ZIF socket (Intel® Socket 7). This socket is designed for easy removal of an old processor and easy insertion of an upgrade processor. It is also equipped with a switching voltage regulator that supports 2.8V, 2.9V, 3.2V, 3.3V and 3.5V core voltage for various processors.

- Intel Pentium® processor with MMX™ technology-166/200/233MHz
- Intel Pentium® 90/100/120/133/150/166/200MHz
- Cyrix® 6x86 and 6x86L PR150+/PR166+
- Cyrix® 6x86MX-PR166/PR200
- AMD® K5 PR90/PR100/PR120/PR133/PR166
- AMD® K6-166, K6-200, K6-233

Chipset

- Intel® 82430TX PCIset chipset

System Memory

The system board supports 8MB to 256MB of memory. It is equipped with two DIMM and four SIMM sockets. The 168-pin DIMM sockets use x64 EDO (60/70ns), fast page mode (60/70ns), or SDRAM (10/12/13ns), 3.3V. The 72-pin SIMM sockets use EDO or fast page mode, 60/70ns, x32 DRAM, 5V.

Cache Memory

- 512KB pipeline burst, direct map write-back cache installed on the system board.

BIOS

- Award BIOS, Windows® 95 Plug and Play compatible
- Flash EPROM for easy BIOS upgrades
- Supports DMI function

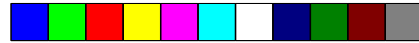

1

586ITOX System Board User's Manual

Energy Efficient Design

- System power management supported
- CPU stopped clock control
- Hardware supports SMI green mode
- Microsoft®/Intel® APM 1.2 compliant
- Soft Power supported - ACPI v1.0a specification

ACPI Specification and OS Directed Power Management

The system board is designed to meet the ACPI (Advanced Configuration Power Interface) specification. It has energy saving features which enable operating systems to reliably manage and coordinate power planes, PnP (Plug-and-Play) peripherals, and cooling fans. The system board is PC 97 compliant. Microsoft®'s PC 97 "OnNow" design allows continual "power on" with reduced energy consumption.

RTC Timer to Power On the System

The RTC installed on the system board allows your system to automatically wake up on the set day and time. Set the day and time you would like your system to power on in the "Resume By Alarm" field (Power Management Setup) of the Award BIOS.

Modem Wake-up/Ring-on

The Modem Wake-Up feature allows the sleeping (Suspend mode) PC to wake-up to respond to incoming calls. The Modem Ring-on feature allows the Soft Power Down (Soft-Off) PC to power on to respond to incoming calls.

Enable this function in the "Resume By Ring" field (Power Management Setup) of the Award BIOS and set JP10 to the COM port where your modem is connected.



Note:

This feature supports external modem only.



Damage Free Intelligence

- Monitors processor temperature and overheat alarm.

If the temperature of the processor is over 85°C, an alarm will sound and the Green LED will illuminate warning you of system overheat.

Some of the most common causes leading to high temperature are:

- The fan is not functioning normally or has stopped. Turn off your system and replace the fan.
- The space clearance of the processor, fan and heat sink is inadequate to maintain proper airflow and heat dissipation. Refer to the Clearance Requirements section in Chapter 3 of this manual.
- The chassis or cabinet has poor ventilation.

- Monitors 5V and 12V power voltages and failure alarm.

The system board is able to detect the output voltage of your power supply. If the output voltage is over or under 5V or 12V ($\pm 10\%$), an alarm will sound warning you of voltage irregularity.

Some of the most common causes leading to unstable output voltage of a power supply are:

- The power supply is not functioning normally. Turn off your system and replace the power supply.
- The AC input from the power outlet to your system is unstable.

- Automatic processor fan control to save energy, prevent system overheat, prolong fan life and implement silent system.

With the system's power switched on, the processor's fan will rotate only if the temperature of the processor is over 25°C ($\pm 10\%$).

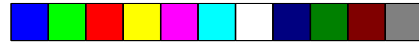

1

586ITOX System Board User's Manual

Dual Function Power Button

Dual Function Power Button allows two distinct OFF modes. In Sleep mode, a PC powers down but not off. In Soft-Off, a PC shuts down but requires a reboot to "awaken" it. "Soft-Off By PWR-BTTN" in the Power Management Setup of the Award BIOS allows you to select the method of powering off your system.

Watchdog Timer

The system board is designed for Industrial PC applications. It supports the Watchdog Timer function allowing your application to regularly "clear" the system at the set time interval. If the system hangs or fails to function, it will reset at the set time interval so that your system will continue to operate. Refer to "Watchdog Timer" in the Chipset Features Setup of the Award BIOS.

- 8 step counter (0.5/1/2/4/8/16/32/64 sec) controlled by the BIOS

Onboard Graphics Accelerator

- S3 Trio64V+ accelerated 64-bit graphics controller
- 1MB video memory onboard
- Video Playback feature
- VESA DDC2B for Plug and Play monitors



Note:

The 586ITOX/L system board is not equipped with the S3 graphics controller, therefore, it does not support graphics features.

HDD Interface

- Two PCI IDE interfaces support up to four IDE devices
- Ultra DMA/33 supported (Synchronous DMA mode - data transfer rate up to 33MB/sec.)
- PIO Mode 3 and Mode 4 Enhanced IDE (data transfer rate up to 16.6MB/sec.)
- Bus mastering reduces CPU utilization during disk transfer
- ATAPI CD-ROM supported



FDD Interface

- One floppy drive interface supports two 360KB, 720KB, 1.2MB, 1.44MB, or 2.88MB floppy drives.

ATX Double Deck Ports

- Two DB-9 serial ports
- One DB-25 parallel port
- One mini-DIN-6 PS/2 mouse port
- One mini-DIN-6 PS/2 keyboard port
- One 15-pin analog VGA port
- Two USB ports

USB Ports

The system board is equipped with two USB ports. USB allows data exchange between your computer and a wide range of simultaneously accessible external Plug and Play peripherals.

IrDA Interface

The system board is equipped with an IrDA connector for wireless connectivity between your computer and peripheral devices.

Expansion Slots

The system board is equipped with one dedicated PCI slots, five dedicated 16-bit ISA slots and one shared PCI/ISA slot. All PCI slots are bus masters.

ATX Power Supply Connector

The system board is equipped with an ATX power supply connector. Using an ATX power supply, you can either shut down your computer by pressing the Power button located on the front bezel of your computer or by executing the Shut Down command under the Windows® 95 operating system. Your system will then enter the "Soft Off" state.

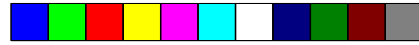

1

586ITOX System Board User's Manual

To power on your system automatically, enable "Resume By Alarm" in the Power Management Setup of the Award BIOS. This will allow you to set the day and time you would like your system to wake up.

An ATX power supply also provides adequate airflow throughout the chassis to prevent overheating the processor.

Package Checklist

The 586ITOX package contains the following items:

- The 586ITOX system board
- The 586ITOX user's manual
- One 40-pin IDE hard disk cable
- One 34-pin floppy disk drive cable
- One IDE driver diskette
- One VGA driver diskette (586ITOX only)
- One I/O shield
- Five spare jumpers

If any of these items are missing or damaged, please contact your dealer or sales representative for assistance.



CHAPTER

2

Award BIOS Setup Utility



2

The Basic Input/Output System

The Basic Input/Output System (BIOS) is a program that takes care of the basic level of communication between the processor and peripherals. In addition, the BIOS also contain codes for various advanced features found in this system board. This chapter explains the Setup Utility for the Award BIOS.

After you power up your system, the BIOS message appears on your screen and the memory count begins. After the memory test, the following message will appear on the screen:

Press DEL to enter setup

If the message disappears before you respond, restart your system or press the "Reset" button. You may also restart the system by pressing the <Ctrl> <Alt> and keys simultaneously.

When you press , the main program screen will appear.

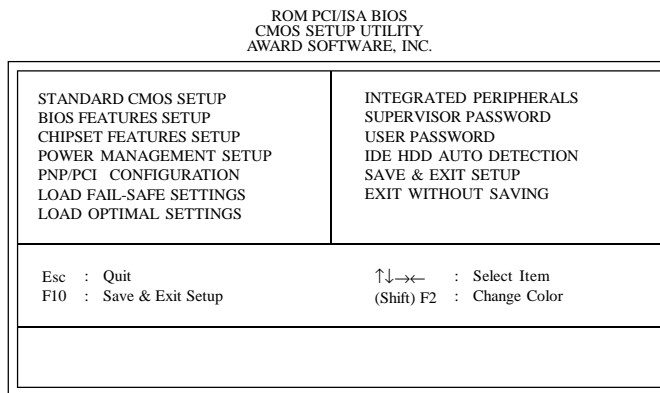

Standard CMOS Setup

Use the arrow keys to highlight "Standard CMOS Setup" and press <Enter>. A screen similar to the one on the next page will appear.

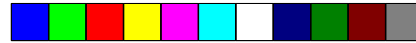

Award BIOS Setup Utility

ROM PCI/ISA BIOS
STANDARD CMOS SETUP
AWARD SOFTWARE, INC.

Date (mm:dd:yy) : Mon, Jul 29 1996								
Time (hh:mm:ss) : 13: 27: 50								
HARD DISKS	TYPE	SIZE	CYLS	HEAD	PRECOMP	LANDZ	SECTOR	MODE
Primary Master	: Auto	0	0	0	0	0	0	Auto
Primary Slave	: Auto	0	0	0	0	0	0	Auto
Secondary Master	: Auto	0	0	0	0	0	0	Auto
Secondary Slave	: Auto	0	0	0	0	0	0	Auto
Drive A : 1.44M, 3.5 in.								
Drive B : None								
Video : EGA/VGA						Base Memory : 640K		
Halt on : All Errors						Extended Memory : 64512K		
						Other Memory : 384K		
						Total Memory : 65536K		
Esc : Quit			↑↓→← : Select Item			PU/PD/+/- : Modify		
F10 : Save & Exit Setup			(Shift)F2 : Change					

The settings on the screen are for reference only. Your version may not be identical to this one.

Date

The date format is <day>, <month>, <date>, <year>. Day displays a day, from Sunday to Saturday. Month displays the month, from January to December. Date displays the date, from 1 to 31. Year displays the year, from 1994 to 2079.

Time

The time format is <hour>, <minute>, <second>. The time is based on the 24-hour military-time clock. For example, 1 p.m. is 13:00:00. Hour displays hours from 00 to 23. Minute displays minutes from 00 to 59. Second displays seconds from 00 to 59.

Primary Master, Primary Slave, Secondary Master and Secondary Slave

These categories allow you to enter the appropriate specifications for the type of hard disk drive(s) installed in your system. There are 45 predefined types and 4 user definable types for hard drives. Type 1 to Type 45 are predefined. Type "User" is user-definable.

Press <PgUp> or <PgDn> to select a numbered hard disk type or type the number and press <Enter>. The hard disk will not work properly if you enter improper information for this category.

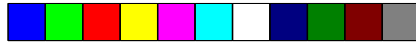

2

586ITOX System Board User's Manual

You can use Type "User" to define your own drive type manually. This information should be included in the documentation from your hard disk vendor.

If the controller of the HDD interface is ESDI, you must select "Type 1". If the controller of the HDD interface is SCSI, you must select "None".

If you select Type "Auto", the BIOS will auto-detect the HDD & CD-ROM drive at the POST stage and show the IDE for the HDD & CD-ROM drive. If a hard disk has not been installed, select "None" and press <Enter>.

Drive A and Drive B

These categories identify the types of floppy disk drives installed. The options for drive A and B are:

- None* No floppy drive is installed
- 360K, 5.25 in.* 5-1/4 in. standard drive; 360KB capacity
- 1.2M, 5.25 in.* 5-1/4 in. AT-type high-density drive; 1.2MB capacity
- 720K, 3.5 in.* 3-1/2 in. double-sided drive; 720KB capacity
- 1.44M, 3.5 in.* 3-1/2 in. double-sided drive; 1.44MB capacity
- 2.88M, 3.5 in.* 3-1/2 in. double-sided drive; 2.88MB capacity



Note:

Choosing an incorrect type might cause your system to format the floppy disk improperly and you cannot access your data.

Video

This category selects the type of video adapter used for the primary system monitor. Although secondary monitors are supported, you do not have to select the type in Setup. The default setting is EGAVGA (BIOS default, Setup default).

- EGAVGA* Enhanced Graphics Adapter/Video Graphics Array. For EGA, VGA, SVGA and PGA monitor adapters.
- CGA 40* Color Graphics Adapter. Power up in 40-column mode.
- CGA 80* Color Graphics Adapter. Power up in 80-column mode.
- Mono* Monochrome adapter. Includes high resolution monochrome adapters.



Halt On

This category determines whether the system will stop if an error is detected during power up. The default setting is All Errors (BIOS default, Setup default).

- No Errors* The system boot will not stop for any errors detected.
- All Errors* The system boot will stop whenever the BIOS detects a non-fatal error.
- All, But Keyboard* The system boot will not stop for a keyboard error; it will stop for all other errors.
- All, But Diskette* The system boot will not stop for a disk error; it will stop for all other errors.
- All, But Disk/Key* The system boot will not stop for a disk or keyboard error; it will stop for all other errors.

Memory

The base memory size, extended memory size and the other memory size cannot be altered; your computer automatically detects and displays them.

- Base Memory* The POST will determine the amount of base (or conventional) memory installed in the system. The value of the base memory is typically 512K for systems with 512K memory installed on the motherboard or 640K for systems with 640K or more memory installed on the motherboard.
- Extended Memory* The BIOS determines how much extended memory is present during the POST. This is the amount of memory located above 1MB in the CPU's memory address map.
- Other Memory* This refers to the memory located in the 640K to 1024K address space. This is the memory that can be used for different applications. DOS uses this area to load device drivers in an effort to keep as much base memory free for application programs. The BIOS is the most frequent user of this RAM area since this is where it shadows the ROM.

BIOS Features Setup

The BIOS Features Setup allows you to configure your system for basic operation. Some entries are defaults required by the system board, while others, if enabled, will improve the performance of your system or let you set some features according to your preference.

ROM PCI/ISA BIOS BIOS FEATURES SETUP AWARD SOFTWARE, INC.			
Virus Warning	: Disabled	Video BIOS Shadow	: Enabled
CPU Internal Cache	: Enabled	C8000-CBFFF Shadow	: Disabled
External Cache	: Enabled	CC000-CFFFF Shadow	: Disabled
Quick Power On Self Test	: Disabled	D0000-D3FFF Shadow	: Disabled
Boot Sequence	: A, C, SCSI	D4000-D7FFF Shadow	: Disabled
Swap Floppy Drive	: Disabled	D8000-DBFFF Shadow	: Disabled
Boot Up Floppy Seek	: Enabled	DC000-DFFFF Shadow	: Disabled
Boot Up NumLock Status	: On		
Typematic Rate Setting	: Disabled		
Typematic Rate (Chars/Sec)	: 6		
Typematic Delay (Msec)	: 250		
Security Option	: Setup		
PCL/VGA Palette Snoop	: Disabled		
OS Select For DRAM > 64MB	: Non-OS2		
		ESC : Quit	↑↓←→ : Select Item
		F1 : Help	PU/PD+/- : Modify
		F5 : Old Values (Shift) F2	: Color
		F6 : Load Fail-Safe Settings	
		F7 : Load Optimal Settings	

The settings on the screen are for reference only. Your version may not be identical to this one.

Virus Warning

This category protects the boot sector and partition table of your hard disk drive. When this item is enabled, the Award BIOS will monitor the boot sector and partition table of the hard disk drive. If an attempt is made to write to the boot sector or partition table of the hard disk drive, the BIOS will halt the system and an error message will appear.

After seeing the error message, if necessary, you will be able to run an anti-virus program to locate and remove the problem before any damage is done.

Many disk diagnostic programs which attempt to access the boot sector table will cause the warning message to appear. If you are running such a program, we recommend that you first disable this category. Also, disable this category if you are installing or running certain operating systems like Windows® 95 or the operating system may not install nor work.



2

..... Award BIOS Setup Utility

CPU Internal Cache and External Cache

These categories speed up the memory access. The default value is enabled. Enable the External Cache for better performance.

Quick Power On Self Test

This category speeds up Power On Self Test (POST) after you power on your system. If it is set to Enabled, the BIOS will shorten or skip some check items during POST.

Boot Sequence

This category determines which drive to search first for the disk operating system (i.e. DOS). The default is A, C, SCSI.

The options are:

- | | | | |
|-------------|-------------|--------------|--------------|
| A, C, SCSI; | C, A, SCSI; | C, CDROM, A; | CDROM, C, A; |
| D, A, SCSI; | E, A, SCSI; | F, A, SCSI; | SCSI, A, C; |
| SCSI, C, A; | C only; | LSZIP, C. | |

Swap Floppy Drive

When this option is enabled and the system is booting from the floppy drive, the system will boot from drive B instead of drive A. When this option is disabled and the system is booting from the floppy drive, the system will boot from drive A. You must have two floppy drives to use this function.

Boot Up Floppy Seek

When enabled, the BIOS will check whether the floppy disk drive installed is 40 or 80 tracks. Note that the BIOS cannot distinguish between 720K, 1.2M, 1.44M and 2.88M drive types as they are all 80 tracks. When disabled, the BIOS will not search for the type of floppy disk drive by track number. Note that there will not be any warning message if the drive installed is 360KB.

Boot Up NumLock Status

This allows you to determine the default state of the numeric keypad. By default, the system boots up with NumLock on wherein the function

of the numeric keypad is the number keys. When set to Off, the function of the numeric keypad is the arrow keys.

Typematic Rate Setting

When disabled, continually holding down a key on your keyboard will cause the BIOS to report that the key is down. When the typematic rate is enabled, the BIOS will not only report that the key is down, but will first wait for a moment, and, if the key is still down, it will begin to report that the key has been depressed repeatedly. For example, you would use such a feature to accelerate cursor movements with the arrow keys.

Typematic Rate (Chars/Sec)

This selection allows you to select the rate at which the keys are accelerated.

Typematic Delay (Msec)

This selection allows you to select the delay between when the key was first depressed and when the acceleration begins.

Security Option

System The system will not boot and access to Setup will be denied if the correct password is not entered at the prompt.

Setup The system will boot, but access to Setup will be denied if the correct password is not entered at the prompt.

PCI/VGA Palette Snoop

It determines whether the MPEG ISA/VESA VGA Cards can work with PCI/VGA or not. The default value is Disabled.

Enabled PCI/VGA working with MPEG ISA/VESA VGA cards.

Disabled PCI/VGA not working with MPEG ISA/VESA VGA cards.

OS Select for DRAM > 64MB

This item allows you to access the memory that is over 64MB in OS/2. The options are: Non-OS/2 and OS/2.



2

Award BIOS Setup Utility

Video BIOS Shadow

Determines whether video BIOS will be copied to RAM. Video Shadow will increase the video speed. Note that some graphics boards require that this option be disabled. The default value is Enabled.

Enabled Video shadow is enabled.

Disabled Video shadow is disabled.

C8000-CBFFF Shadow to DC000-DFFFF Shadow

These categories determine whether option ROMs will be copied to RAM.

Enabled Optional shadow is enabled.

Disabled Optional shadow is disabled.

2

Chipset Features Setup

ROM PCI/ISA BIOS
CHIPSET FEATURES SETUP
AWARD SOFTWARE, INC.

Auto Configuration	: Enabled	Software Power-off	: Disabled
DRAM Timing	: Normal	Watchdog Timer	: 1 sec
DRAM Leadoff Timing	: 11/7/3		
DRAM Read Burst (EDO/FP)	: x333/x444		
DRAM Write Burst Timing	: x333		
Fast EDO Lead Off	: Disabled		
Refresh RAS# Assertion	: 5 Clks		
Fast RAS To CAS Delay	: 3		
DRAM Page Idle Timer	: 4 Clks		
DRAM Enhanced Paging	: Enabled		
Fast MA to RAS# Delay	: 2 Clks		
SDRAM (CAS Lat/RAS-to-CAS)	: 3/3		
System BIOS Cacheable	: Disabled		
Video BIOS Cacheable	: Disabled		
8 Bit I/O Recovery Time	: 4	ESC : Quit	↑ ↓ → ← : Select Item
16 Bit I/O Recovery Time	: 2	F1 : Help	PU/PD/+/- : Modify
Memory Hole At 15M-16M	: Disabled	F5 : Old Values (Shift) F2 : Color	
Extended CPU-PIIX4 PHLDA#	: Disabled	F6 : Load Fail-Safe Settings	
Host-to-PCI Bridge Retry	: Disabled	F7 : Load Optimal Settings	
PCI Concurrency	: Enabled		
Mem. Drive Str. (MA/RAS)	: 16mA/16mA		

The settings on the screen are for reference only. Your version may not be identical to this one.

This section gives you functions to configure the system based on the specific features of the chipset. The chipset manages bus speeds and access to system memory resources. It also coordinates communications between the conventional ISA bus and the PCI bus. These items should not be altered unless necessary. Depending on your add-in boards, you may not or should not enable some of those features. The default settings have been chosen because they provide the best operating conditions for your system. The only time you might consider making any changes would be if you discovered some incompatibility or that data was being lost while using your system.



Software Power-off

Enabled Uses the ATX power supply to “Soft Power On/Off” the PC.

Disabled Default setting. Uses the AC power to power on/off the PC. In this setting, the ATX power supply is always On and will turn Off only when the AC power is Off or disconnected from the PC.

The advantages of this setting are:

1. When power returns after a power failure, the PC will continue to operate.
2. You can use the AC power to power on/off the PC.

When “Software Power-off” is set to Enabled, JP13 pins 1 and 2 must be set to On. When Disabled, JP13 pins 2 and 3 must be set to On.

Watchdog Timer

The system board supports the Watchdog Timer function allowing your application to regularly “clear” the system at the set time interval. If the system hangs or fails to function, it will reset at the set time interval so that your system will continue to operate. You may set the time interval in 0.5, 1, 2, 4, 8, 16, 32 or 64 sec. The default is 1 sec.

Refer to Appendix E for instructions on using the Watchdog Timer function.

Power Management Setup

The Power Management Setup allows you to configure your system to most effectively save energy. If you like to use the soft power down feature of Windows 95, you must enable the Power Management below. Select Min. Power, Max. Power or User Defined. Either one can be used as long as it is NOT disabled.

ROM PCI/ISA BIOS
POWER MANAGEMENT SETUP
AWARD SOFTWARE, INC.

Power Management	: Disabled	** Reload Global Timer Events **	
PM Control by APM	: Yes	IRQ [3-7, 9-15], NMI	: Enabled
Video Off Method	: V/H SYNC+Blank	Primary IDE 0	: Disabled
Video Off After	: Standby	Primary IDE 1	: Disabled
Doze Mode	: Disabled	Secondary IDE 0	: Disabled
Standby Mode	: Disabled	Secondary IDE 1	: Disabled
Suspend Mode	: Disabled	Floppy Disk	: Disabled
HDD Power Down	: Disabled	Serial Port	: Enabled
Throttle Duty Cycle	: 62.5%	Parallel Port	: Disabled
VGA Active Monitor	: Enabled		
Soft-Off by PWR-BTTN	: Hold 4 Sec.		
Resume by Ring	: Enabled	ESC : Quit	↑ ↓ → ← : Select Item
Resume by Alarm	: Disabled	F1 : Help	PU/PD/+/- : Modify
** Break Event From Suspend **		F5 : Old Values (Shift) F2 : Color	
IRQ 8 Clock Event	: Disabled	F6 : Load Fail-Safe Settings	
		F7 : Load Optimal Settings	

The settings on the screen are for reference only. Your version may not be identical to this one.

Power Management

This category allows you to select the type (or degree) of power saving by changing the length of idle time that elapses before each of the following modes are activated: Doze mode, Standby mode, and Suspend mode.

Disable No power management. Disables the Doze, Standby and Suspend modes.

Min. Power Saving Minimum power management. Doze Mode = 1 hr., Standby Mode = 1 hr., and Suspend Mode = 1 hr.

Max. Power Saving Maximum power management. Doze Mode = 1 min., Standby Mode = 1 min., and Suspend Mode = 1 min.

User Defined Allows you to set each mode individually. When enabled, each option ranges from 1 min. to 1 hr.



PM Control by APM

- Yes** An Advanced Power Management device will be activated to enhance the Max. Power Saving mode and stop the CPU's internal clock. Use this option in Windows® 95. (default)
- No** The system BIOS will ignore APM when initiating the Power Management mode.

Video Off Method

This determines the manner in which the monitor is blanked.

- V/H SYNC + Blank** This selection will cause the system to turn off the vertical and horizontal synchronization ports and write blanks to the video buffer.
- Blank Screen** This option only writes blanks to the video buffer.
- DPMS** Initializes display power management signaling. Use this option if your video board supports it.

Video Off After

- N/A** The system BIOS will never turn off the screen.
- Suspend** The screen is off when the system is in the Suspend mode.
- Standby** The screen is off when the system is in the Standby mode.
- Doze** The screen is off when the system is in the Doze mode.

Doze Mode

This is user configurable only when the Power Management category is set to User Defined. When enabled and after the set time of system inactivity, the CPU clock will run at a slower speed (1/2 of full speed) while all other devices still operate at full speed.

Standby Mode

This is user configurable only when the Power Management category is set to User Defined. When enabled and after the set time of system inactivity, the CPU clock will run at a speed slower than the speed during Doze mode (1/3 of full speed) while all other devices still operate at full speed.

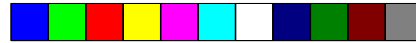

2

586ITOX System Board User's Manual

Suspend Mode

This is user configurable only when the Power Management category is set to User Defined. When enabled and after the set time of system inactivity, the CPU and onboard peripherals will be shut off.

HDD Power Down

This is user configurable only when the Power Management category is set to User Defined. When enabled and after the set time of system inactivity, the hard disk drive will be powered down while all other devices remain active.

Throttle Duty Cycle

This category allows you to select the rate of reduction with your external system bus clock to save power.

Options 12.5%, 25.0%, 37.5%, 50.0%, 62.5%, 75.0%, and 87.5%

Default 62.5%

VGA Active Monitor

Enabled VGA activities will cause the system to wake up from power saving mode.

Disabled VGA activities will not cause the system to wake up from power saving mode.

Soft-Off by PWR-BTTN

This category allows you to select the method of powering off your system.

Hold 4 Sec. Press the power button for more than 4 seconds to Soft power off (Soft-Off) your system. If the power button is released in less than 4 sec. time, your system will enter the Suspend mode.

Instant-Off Pressing and then releasing the power button at once will immediately power off your system.



2

Award BIOS Setup Utility

Resume By Ring

Enabled Enables the Modem Ring-on feature. This allows your system to power on to respond to incoming calls. Make sure JP10 is set according to the COM port where your modem is connected.

Disabled Disables the Modem Ring-on feature. Your system will not respond to incoming calls.

Resume By Alarm

Enabled When Enabled, you can set the day and time you would like your system to wake up.

Disabled Disables the automatic wake up function. (default)

Break Event From Suspend and Reload Global Timer Events

When enabled, access to the specified IRQ will cause the system to wake up completely from the power management mode. When disabled, the system will not wake up from the power management mode despite access to the specified IRQ.

2

PNP/PCI Configuration

This section describes configuring the PCI bus system. It covers some very technical items and it is strongly recommended that only experienced users should make any changes to the default settings.

ROM PCI/ISA BIOS
PNP/PCI CONFIGURATION
AWARD SOFTWARE, INC.

PNP OS Installed	: No	PCI IDE IRQ Map To	: PCI-Auto
Resources Controlled By	: Auto	Primary IDE INT#	: A
Reset Configuration Data	: Disabled	Secondary IDE INT#	: B
		Assign IRQ for VGA	: Enabled
		ESC : Quit ↑↓→← : Select Item	
		F1 : Help PU/PD/+/- : Modify	
		F5 : Old Values (Shift) F2 : Color	
		F6 : Load Fail-Safe Settings	
		F7 : Load Optimal Settings	

The settings on the screen are for reference only. Your version may not be identical to this one.

PNP OS Installed

This category is used to enable or disable Plug and Play with your operating system.

- Yes** Select this option when you need Windows 95 to detect the Plug and Play devices automatically.
- No** Select this option when you need the BIOS to detect the Plug and Play devices for some compatible resources. We recommend that you select this option. (default)



2

Award BIOS Setup Utility

Resources Controlled By

The Award Plug and Play BIOS has the capability to automatically configure all of the boot and Plug and Play compatible devices.

- Auto* The system will automatically detect the settings for you. The categories that follow will not be shown on the screen.
- Manual* This will allow you to set the IRQ/DMA (you have assigned your add-in card) to Legacy ISA or PCI/ISA PnP. For non-PnP ISA cards, select Legacy ISA. For PnP ISA or PCI cards, select PCI/ISA PnP.

Reset Configuration Data

- Enabled* The BIOS will reset the configuration data once automatically. It will then recreate a new set of configuration data.
- Disabled* The BIOS will not reset the configuration data.

PCI IDE IRQ Map To

This category is used to configure your system to the type of IDE disk controller in use.

- PCI-Auto* The system will scan and determine the PCI slot that is installed with an IDE controller card.
- ISA* Designates the ISA slot that is installed with an IDE controller card; that is, if you are using an IDE controller card.

Primary IDE INT# and Secondary IDE INT#

The Primary and Secondary IDE INT# categories are used to select the PCI interrupt (A, B, C, or D) that is associated with the connected hard drives.

Assign IRQ for VGA

If Enabled, the system will automatically set an IRQ for the VGA card installed. Your VGA card will need an IRQ address only when using the video capture function of the card. If you are not using this function and a new device requires an IRQ address, you can set this function to Disabled. The IRQ address (previously occupied by the VGA card) will be available for your new device.



Note:

When Disabled, a "Yellow" mark will appear in Windows[®] 95's Device Manager.

Load Fail-Safe Settings

The "Load Fail-Safe Settings" option loads the troubleshooting default values permanently stored in the ROM chips. These settings are not optimal and turn off all high performance features. You should use these values only if you have hardware problems. Highlight this option on the main menu and press <Enter>. The message below will appear.

Load Fail-Safe Settings (Y/N)? N

If you want to proceed, type <Y> and press <Enter>. The default settings will be loaded.

Load Optimal Settings

The "Load Optimal Settings" option loads optimized settings from the BIOS ROM. Use the Setup default values as standard values for your system.

Highlight this option on the main menu and press <Enter>. The message below will appear.

Load Optimal Settings (Y/N)? N

Type <Y> and press <Enter> to load the Setup default values.



Integrated Peripherals

ROM PCI/ISA BIOS
INTEGRATED PERIPHERALS
AWARD SOFTWARE, INC.

IDE HDD Block Mode : Enabled	KBC input clock : 8MHz
IDE Primary Master PIO : Auto	Onboard FDC Controller : Enabled
IDE Primary Slave PIO : Auto	Onboard Serial Port 1 : 3F8/IRQ4
IDE Secondary Master PIO : Auto	Onboard Serial Port 2 : 2F8/IRQ3
IDE Secondary Slave PIO : Auto	UART2 Mode Select : Normal
IDE Primary Master UDMA : Auto	
IDE Primary Slave UDMA : Auto	Onboard Parallel Port : 378/IRQ7
IDE Secondary Master UDMA : Auto	Parallel Port Mode : SPP
IDE Secondary Slave UDMA : Auto	
On-chip Primary PCI IDE : Enabled	
On-chip Secondary PCI IDE : Enabled	
ESC : Quit ↑↓→← : Select Item F1 : Help PU/PD/+/- : Modify F5 : Old Values (Shift) F2 : Color F6 : Load Fail-Safe Settings F7 : Load Optimal Settings	

The settings on the screen are for reference only. Your version may not be identical to this one.

IDE HDD Block Mode

Enabled The IDE HDD uses the block mode. The system BIOS will check the hard disk drive for the maximum block size the system can transfer. The block size will depend on the type of hard disk drive.

Disabled The IDE HDD uses the standard mode.

IDE Primary Master/Slave PIO and IDE Secondary Master/Slave PIO

PIO means Programmed Input/Output. Rather than have the BIOS issue a series of commands to effect a transfer to or from the disk drive, PIO allows the BIOS to tell the controller what it wants and then let the controller and the CPU perform the complete task by themselves. Your system supports five modes, 0 (default) to 4, which primarily differ in timing. When Auto is selected, the BIOS will select the best available mode after checking your drive.

Auto The BIOS will automatically set the system according to your hard disk drive's timing.

0-4 You can select a mode that matches your hard disk drive's timing. Caution: Do not use the wrong setting or you will have drive errors.

IDE Primary Master/Slave UDMA and IDE Secondary Master/Slave UDMA

These categories allow you to set the Ultra DMA in use. When Auto is selected, the BIOS will select the best available option after checking your hard drive or CD-ROM.

- Auto* The BIOS will automatically detect the settings for you.
- Disabled* The BIOS will not detect these categories.

On-Chip Primary PCI IDE and On-Chip Secondary PCI IDE

These categories allow you to enable or disable the primary and secondary IDE controller. The default is Enabled. Select Disabled if you want to add a different hard drive controller.

KBC Input Clock

This is used to select the input clock of your keyboard. The options are: 6MHz, 8MHz, 12MHz and 16MHz. The default is 8MHz.

Onboard FDC Controller

- Enabled* Enables the onboard floppy disk controller.
- Disabled* Disables the onboard floppy disk controller.

Onboard Serial Port 1 and Onboard Serial Port 2

- Auto* The system will automatically select an I/O address for the onboard serial port 1 and serial port 2.
- 3F8/IRQ4, 2F8/IRQ3, 3E8/IRQ4, 2E8/IRQ3* Allows you to manually select an I/O address for the onboard serial port 1 and serial port 2.
- Disabled* Disables the onboard serial port 1 and/or serial port 2.



2

Award BIOS Setup Utility

UART2 Mode Select

The system board supports IrDA function for wireless connectivity between your computer and peripheral devices.

You may not use IrDA (J16) and the COM 2 serial port at the same time. If you are using the COM 2 serial port, make sure "UART2 Mode Select" is set to Normal.

To use the IrDA function, follow the steps below.

1. Connect your IrDA cable to connector J16 on the system board.
2. Set "UART2 Mode Select" to the type of IrDA standard supported by your IrDA peripheral/device (IrDA or ASKIR).
3. The following will appear right after "UART2 Mode Select".

IR Transmission Delay

If this option is Enabled, transmission of data will be slower. This is recommended when you encounter transmission problem with your device. The options are: Enabled and Disabled.



2

586ITOX System Board User's Manual

Onboard Parallel Port

378H/IRQ7, 3BCH/IRQ7, 278H/IRQ5 Selects the I/O address and IRQ for the onboard parallel port.

Disabled Disables the onboard parallel port.

Parallel Port Mode

Parallel Port Mode will appear only if you selected an I/O address and IRQ in Onboard Parallel Port (shown above). This option applies to a standard specification and will depend on the type and speed of your device. Refer to your peripheral's manual for the best option.

Select the parallel port mode according to the type of printer device connected to your onboard parallel port. The parallel modes are SPP, EPP, ECP and ECP+EPP.

If you selected EPP, "EPP Mode Select" will appear. This option applies to standard specification. The options are EPP1.9 and EPP1.7. Default setting: EPP1.9.

If you selected ECP, "ECP Mode Use DMA" will appear. This is used to select a DMA channel for the parallel port. The options are 1 and 3. Default setting: 3.

If you selected ECP+EPP, "ECP Mode Use DMA" and "EPP Mode Select" will both appear on the screen.

Supervisor Password

If you want to protect your system and setup from unauthorized entry, set a supervisor's password with the "System" option selected in the BIOS Features Setup.

If you want to protect access to setup only, but not your system, set a supervisor's password with the "Setup" option selected in the BIOS Features Setup. You will not be prompted for a password when you cold boot the system.

Use the arrow keys to highlight the "Supervisor Password" option and press <Enter>. The message below will appear.



2

Award BIOS Setup Utility

Enter Password:

Type in the password. You are limited to eight characters. When done, the message below will appear:

Confirm Password:

You are asked to verify the password. Type in exactly the same password. If you type in a wrong password, you will be prompted to enter the correct password again.

To delete or disable the password function, highlight "Supervisor Password" and press <Enter>, instead of typing in a new password. Press the <Esc> key to return to the main menu.

User Password

If you want another user to have access only to your system but not to setup, set a user's password with the "System" option selected in the BIOS Features Setup.

If you want a user to enter a password when trying to access setup, set a user's password with the "Setup" option selected in the BIOS Features Setup. Using user's password to enter Setup allows a user to access only the "User Password" option that appears on the main screen. Access to all other options is denied.

To set, confirm, verify, disable or delete a user's password, follow the procedures described in the section "Supervisor Password". If you forget your password, refer to the procedure described in the same section.

2

IDE HDD Auto Detection

Use this option to detect the parameters for the hard disk drives installed in your system. These parameters will then be automatically entered into the "Standard CMOS Setup". The IDE HDD Auto Detection screen displays the following categories of information: Size, Cylinders, Heads, Precomp, LandZone, Sectors and Mode.

ROM PCI/ISA BIOS
CMOS SETUP UTILITY
AWARD SOFTWARE, INC.

HARD DISKS	TYPE	SIZE	CYLS	HEAD	RECOMP	LANDZ	SECTOR	MODE
Primary Master:								
Select Primary Master Option (N=Skip): N								
OPTIONS	SIZE	CYLS	HEAD	PRECOMP	LANDZ	SECTOR	MODE	
2 (Y)	853	827	32	0	653	63	LBA	
1	853	1654	16	65535	1653	63	Normal	
3	853	827	32	65536	1653	63	Large	

Note: Some OS (like SCO-UNIX) must be "NORMAL" for installation

ESC: Skip

The settings on the screen are for reference only. Your version may not be identical to this one.

For hard drives larger than 528MB, you would typically select the LBA type. Certain operating systems require that you select Normal or Large. Please check your operating system's manual or Help desk on which one to select.



2

Award BIOS Setup Utility

Save & Exit Setup

When all the changes have been made, highlight "Save & Exit Setup" and press <Enter>. The message below will appear:

Save to CMOS and Exit (Y/N)? N

Type "Y" and press <Enter>. The modifications you have made will be written into the CMOS memory, and the system will reboot. You will once again see the initial diagnostics on the screen. If you wish to make additional changes to the setup, press <Ctrl> <Alt> <Esc> simultaneously or after memory testing is done.

Exit Without Saving

When you do not want to save the changes you have made, highlight "Exit Without Saving" and press <Enter>. The message below will appear:

Quit Without Saving (Y/N)? N

Type "Y" and press <Enter>. The system will reboot and you will once again see the initial diagnostics on the screen. If you wish to make any changes to the setup, press <Ctrl> <Alt> <Esc> simultaneously or after memory testing is done.

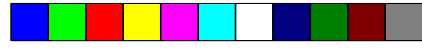

3

586ITOX System Board User's Manual

CHAPTER

3

Upgrade Guide





System Memory

The system board supports two kinds of memory modules: DIMM and SIMM. DIMM, which sometimes uses SDRAM, performs better than SIMM, which uses DRAM. When you are purchasing DIMMs, please specify you want the Intel compatible type. (There are DIMMs made for other types of computers that are not compatible.)



Note:

DIM and SIM modules cannot exist on the system board at the same time. Use either SIMM or DIMM only.

DIMM

The two 168-pin DIMM (Dual In-line Memory Module) sockets use x64 EDO, FPM and SDRAM. The system board can support 8MB to 256MB memory. The table below summarizes the DIMM sockets and modules needed for the corresponding memory sizes.

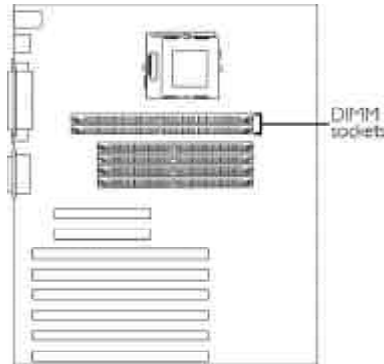

Memory Size	DIM 0	DIM 1
8MB	8MB	none
8MB	none	8MB
16MB	16MB	none
16MB	none	16MB
16MB	8MB	8MB
24MB	8MB	16MB
24MB	16MB	8MB
32MB	32MB	none
32MB	none	32MB

3

Memory Size	DIM 0	DIM 1
32MB	16MB	16MB
40MB	8MB	32MB
40MB	32MB	8MB
48MB	16MB	32MB
48MB	32MB	16MB
64MB	32MB	32MB
128MB	64MB	64MB
256MB	128MB	128MB

Installing the DIM Module

A DIM module simply snaps into a socket on the system board. Pin 1 of the DIM module must correspond with Pin 1 of the socket.

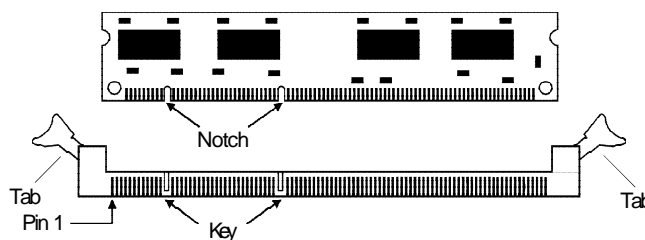

1. Pull the “tabs” which are at the ends of the socket to the side.
2. Position the DIMM above the socket with the “notches” in the module aligned with the “keys” on the socket.
3. Seat the module vertically into the socket. Make sure it is completely seated. The tabs will hold the DIMM in place.



3

SIMM

The SIM sockets are divided into two banks on the system board, Bank 0 and Bank 1. Each bank consists of 2 SIMM sockets.

Your system board supports 8MB to 256MB of memory using 1MBx32, 2MBx32, 4MBx32, 8MBx32 or 16MBx32 72-pin SIMMs (Single In-line Memory Module). You will need 2 or 4 pieces of SIM modules, depending on the amount of memory you intend to install. Make sure you insert the same type of SIMMs in one bank. You can install SIMMs in either banks but you must populate one bank first before going to the next bank.

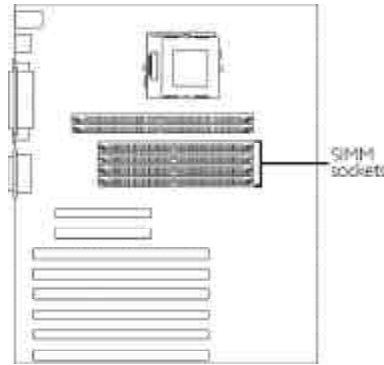

The following table summarizes the bank locations and modules needed for the corresponding memory sizes.

Memory Size	Bank 0		Bank 1	
	SIM3	SIM4	SIM1	SIM2
8MB	4MB	4MB	—	—
8MB	—	—	4MB	4MB
16MB	8MB	8MB	—	—
16MB	—	—	8MB	8MB
16MB	4MB	4MB	4MB	4MB
24MB	4MB	4MB	8MB	8MB
24MB	8MB	8MB	4MB	4MB
32MB	16MB	16MB	—	—
32MB	—	—	16MB	16MB
32MB	8MB	8MB	8MB	8MB

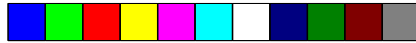

3

586ITOX System Board User's Manual

Memory Size	Bank 0		Bank 1	
	SIM3	SIM4	SIM1	SIM2
40MB	4MB	4MB	16MB	16MB
40MB	16MB	16MB	4MB	4MB
48MB	8MB	8MB	16MB	16MB
48MB	16MB	16MB	8MB	8MB
64MB	32MB	32MB	—	—
64MB	—	—	32MB	32MB
64MB	16MB	16MB	16MB	16MB
72MB	4MB	4MB	32MB	32MB
72MB	32MB	32MB	4MB	4MB
80MB	8MB	8MB	32MB	32MB
80MB	32MB	32MB	8MB	8MB
96MB	16MB	16MB	32MB	32MB
96MB	32MB	32MB	16MB	16MB
128MB	64MB	64MB	—	—
128MB	—	—	64MB	64MB
128MB	32MB	32MB	32MB	32MB
136MB	4MB	4MB	64MB	64MB
136MB	64MB	64MB	4MB	4MB
144MB	8MB	8MB	64MB	64MB
144MB	64MB	64MB	8MB	8MB
160MB	16MB	16MB	64MB	64MB
160MB	64MB	64MB	16MB	16MB
192MB	32MB	32MB	64MB	64MB
192MB	64MB	64MB	32MB	32MB
256MB	64MB	64MB	64MB	64MB





Installing a SIM Module

A SIM module simply snaps into a socket on the system board. Pin 1 of the SIM module must correspond with Pin 1 of the socket.

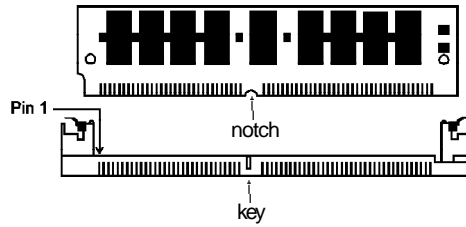

1. Position the SIMM above the socket with the “notch” in the module aligned with the “key” on the socket.
2. Seat the module at a 45° angle into the bank. Make sure it is completely seated. Tilt the module upright until it locks in place in the socket.

Cache Memory

The system board supports 512KB pipeline burst, direct map write-back cache installed at locations U1 and U6 of the system board. One SRAM is mounted on location U10 for tag SRAM to store the cacheable addresses.

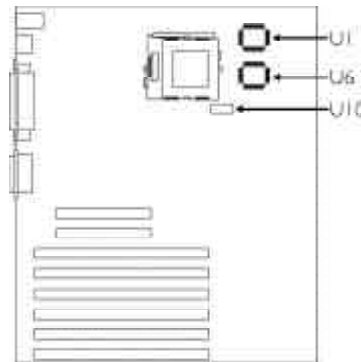

3

Processor Upgrade Information

The system board allows for easy installation of processors. Make sure all jumpers are set correctly before applying power or you may damage the processor or system board. Use a needle-nosed plier to move the jumpers if necessary.

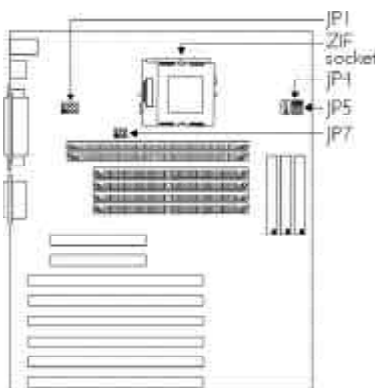

Jumpers JP4, JP5 and JP7 are used to set the external bus clock of your processor. The clock generator will determine the external bus clock that must be sent to the processor through these settings. Refer to the following pages for the external bus clock that corresponds to your processor and set these jumpers accordingly.

After setting these jumpers, an Intel processor will multiply the external bus clock by the frequency ratio to become the internal clock speed. Internal clock speed is the commonly known speed of Intel processors in the market and is the actual operating clock of the processor (external bus clock x frequency ratio = internal clock speed). Cyrix and AMD processors use the PR-rating system which is the overall processor performance rating.

Jumper JP1 is used to set the voltage of your processor. Make sure these jumpers are set correctly, otherwise your system will hang.

The table below shows the External System Bus Clock of the processors supported by the system board and their corresponding PCI Clock and ISA Bus Clock.

Ext. System Bus Clock	PCI CLK	ISA Bus CLK
60MHz	30MHz	7.5MHz
66MHz	33MHz	8.25MHz

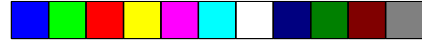

3

Jumper Settings for Intel Processors

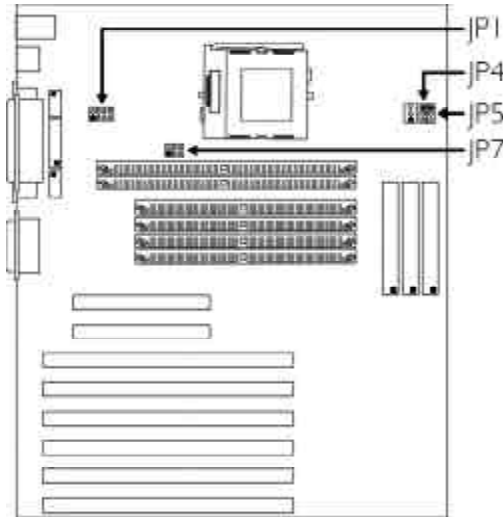

Processors - Ext. Bus CLK	J4	J5	J7
90MHz - 60MHz	1-2 On	2-3 On	All Off
100MHz - 66MHz	2-3 On	1-2 On	All Off
120MHz - 60MHz	1-2 On	2-3 On	1-2 On
133MHz - 66MHz	2-3 On	1-2 On	1-2 On
150MHz - 60MHz	1-2 On	2-3 On	1-2, 3-4 On
166MHz - 66MHz	2-3 On	1-2 On	1-2, 3-4 On
200MHz - 66MHz	2-3 On	1-2 On	3-4 On
MMX166MHz* - 66MHz	2-3 On	1-2 On	1-2, 3-4 On
MMX200MHz - 66MHz	2-3 On	1-2 On	3-4 On
MMX233MHz - 66MHz	2-3 On	1-2 On	All Off

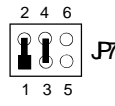
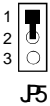
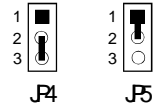

Core Voltage	J1			
	Pins 1-2	Pins 3-4	Pins 5-6	Pins 7-8
2.8V* (MMX)	On	On	On	Off
2.9V	Off	On	On	Off
3.2V	On	On	Off	Off
3.3V (VR)	Off	On	Off	Off
3.5V (VRE)	Off	Off	Off	Off

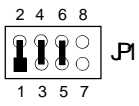

* Default

3

Jumper Settings for Cyrix/IBM Processors

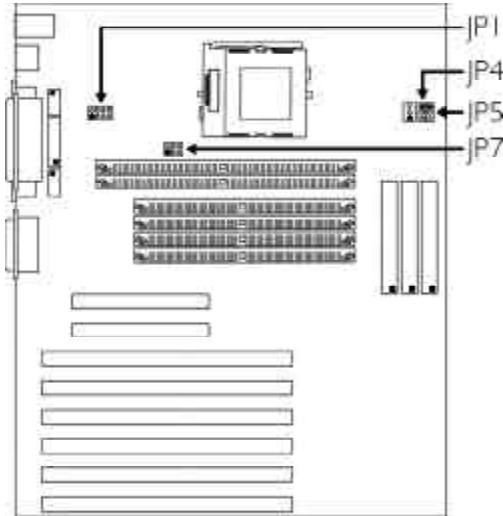

Processor - Ext. Bus CLK	JP4	JP5	JP7
6x86L PR150+ - 60MHz	1-2 On	2-3 On	1-2 On
6x86L PR166+ - 66MHz	2-3 On	1-2 On	1-2 On
6x86MX-PR166 - 60MHz	1-2 On	2-3 On	1-2, 3-4 On
6x86MX-PR166 - 66MHz	2-3 On	1-2 On	1-2 On
6x86MX-PR200 - 66MHz	2-3 On	1-2 On	1-2, 3-4 On

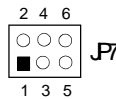
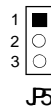
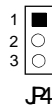

Core Voltage	JP1			
	Pins 1-2	Pins 3-4	Pins 5-6	Pins 7-8
2.8V	On	On	On	Off
2.9V	Off	On	On	Off
3.2V	On	On	Off	Off
3.3V	Off	On	Off	Off
3.5V	Off	Off	Off	Off

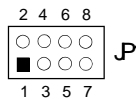

* Default

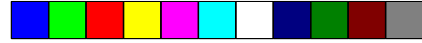

3

Upgrade Guide

Jumper Settings for AMD Processors

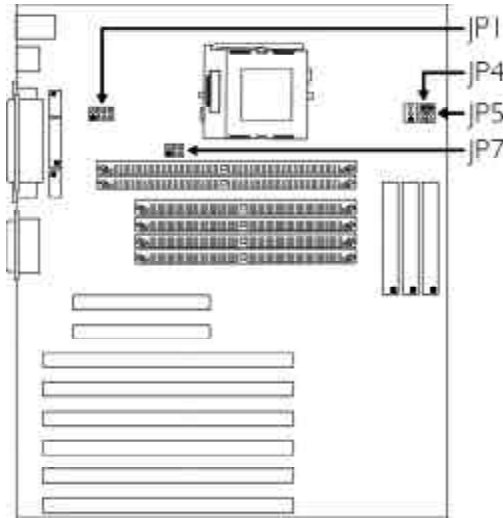

Processor - Ext. Bus CLK	J4	J5	J7
K5 PR90 - 60MHz	1-2 On	2-3 On	All Off
K5 PR100 - 66MHz	2-3 On	1-2 On	All Off
K5 PR120 - 60MHz	1-2 On	2-3 On	All Off
K5 PR133 - 66MHz	2-3 On	1-2 On	All Off
K5 PR166 - 66MHz	2-3 On	1-2 On	1-2, 3-4 On
K6-166 - 66MHz	2-3 On	1-2 On	1-2, 3-4 On
K6-200 - 66MHz	2-3 On	1-2 On	3-4 On
K6-233 - 66MHz	2-3 On	1-2 On	All Off



J4



J5

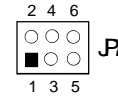

J7

Core Voltage	J1			
	Pins 1-2	Pins 3-4	Pins 5-6	Pins 7-8
2.8V	On	On	On	Off
2.9V (K6-166, K6-200)	Off	On	On	Off
3.2V (K6-233)	On	On	Off	Off
3.3V	Off	On	Off	Off
3.5V	Off	Off	Off	Off

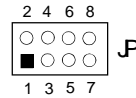

J1

* Default

3

Installing Upgrade Processors

The system board is equipped with a 321-pin Zero Insertion Force (ZIF) socket. This socket is designed for easy removal of an old processor and easy insertion of an upgrade processor. The ZIF socket allows you to carefully place the new processor into its position. If you need to apply excessive force to insert the processor, you are not installing the processor correctly.



Warning:

Open the socket only if you are actually installing a processor. The warranty on the original processor will be voided if the S/N seal is broken. Before proceeding with the upgrade, take note of the following. The microprocessor and heatsink may be hot if the system has been running. To avoid the possibility of a burn, power the system off and let the processor and heatsink cool for 20 minutes.

The 321-pin ZIF socket consists of five rows of pin holes on each side. To prevent improper processor installation, the ZIF socket has a Plug/Keying mechanism. Several holes in the socket are plugged so that the processor will go in only one way. If you cannot easily insert the processor, verify that pin 1 of the processor is aligned with pin 1 of the socket. Also verify that all the pins are straight, and not bent nor broken.

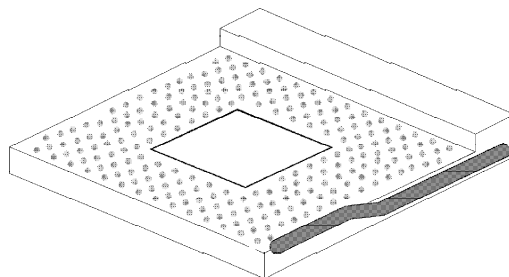

Zero Insertion Force (ZIF) Socket

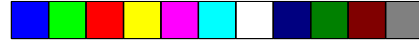

3

Upgrade Guide

To install an upgrade processor, do the following:

1. Make sure the handle on the side of the ZIF socket is up. To raise the handle, push it down, slightly pull it out to the side, then raise it as far as it will go. It may be necessary to initially apply a small amount of sideways force to free the handle from its retaining "tab". Once clear of the "tab", the handle will open relatively easily. The top plate will slide back. Do not use screwdrivers or other tools to open the socket, or you may damage the system or socket.

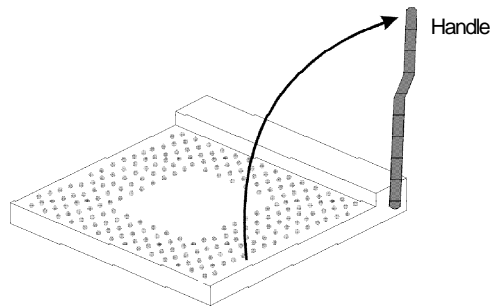

Lifting the Handle

2. Once the lever is completely up, remove the old processor carefully by lifting it straight out of the socket. You are now ready to insert the new processor.

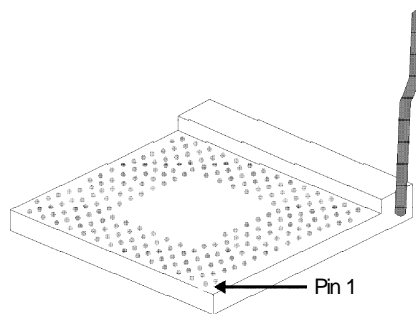

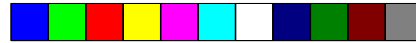

3

586ITOX System Board User's Manual

3. Position the processor above the ZIF socket. Make sure pin 1 of the processor is aligned with pin 1 of the socket. Lower the processor until the pins are inserted properly in their corresponding holes. Remember that very little force is needed to install the processor. If the processor is not easily inserted, verify whether or not pin 1 of the processor is aligned with pin 1 of the socket. Applying too much pressure can damage the processor or the socket.

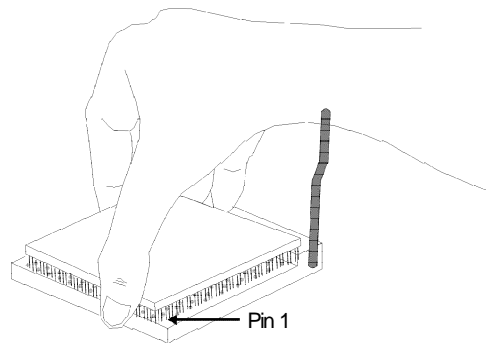

Positioning the Processor above the ZIF Socket

4. Push the handle down until the handle locks into place. The top plate will slide forward. You will feel some resistance as pressure starts to secure the processor in the socket. This is normal and will not damage the processor. However, if the handle is not completely closed, damage to the processor and/or system board may result.



Installing A Fan/Heatsink

Position the fan/heatsink on the processor such that the air from the side of the fan/heatsink will flow across the heat regulators on the system board.

Clearance Requirements

Your processor comes with a heatsink mounted on top. To maintain proper airflow once the upgrade is installed on the system board, the processor and heatsink require certain space clearances. The clearance above the processor's fan/heatsink must be at least 0.4 inches. The clearance on at least 3 of 4 sides of the processor and heatsink must be at least 0.2 inches. All cables (for floppy drive, hard drive, CD-ROM, etc.) must be routed clear of the processor and its airspace.

Fan Exhaust

The processor must be kept cool by using a fan with heatsink. The temperature of the air entering the fan/heatsink cannot exceed 45°C (113°F). The ambient or room temperature must be below 37°C (99°F).

3

Jumper Settings for Modem Ring-on

Jumper JP10
Modem Ring-on Select

The system board supports the Modem Ring-on feature which allows the Soft Power Down (Soft-Off) PC to power on to respond to incoming calls. With an external modem installed, you can remotely transmit or access data without physically going to your system. To "power on" your system, follow the steps below. Make sure "Resume By Ring" in the Power Management Setup is enabled.

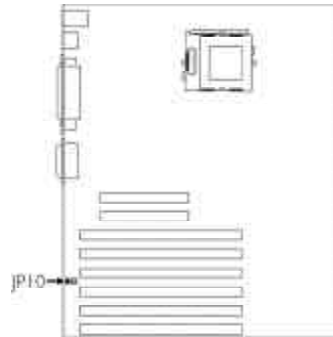

1. Set JP10 according to the COM port where your modem is connected.
2. If your ATX power supply has an On/Off switch, set this to On so that even when you have shut down ("soft power off") your system, it will always remain in "standby" mode. You can shut down your computer by executing the Shut Down command under Windows® 95.
3. Enable Power Management. This will allow your system to enter Suspend mode after you have finished accessing data. Refer to the Power Management Setup section for more information.



Important:

Before connecting your external modem to COM 1 or COM 2, you must first turn on the power of your modem. This is to protect your ATX power supply and system against harmful interference.

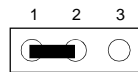

1-2 On: COM 1

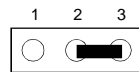

2-3 On: COM 2
(default)

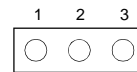

Off: Disabled



Jumper Settings for CMOS Clear

Jumper JP11 CMOS Clear

If, for some reason, the CMOS data becomes corrupted, the system can be reconfigured with the default values stored in the ROM BIOS. To load the default values, power off your system and unplug the power cord. Set JP11 pins 3 and 4 to On. Wait for a few seconds and set JP11 back to its default setting, pins 1 and 2 On. You may now plug the power cord and power on your system.

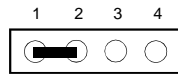
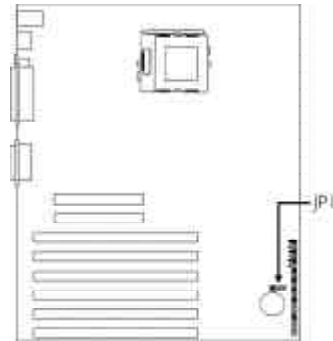

1-2 On: Normal
(default)

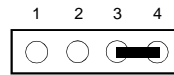

3-4 On: CMOS Clear

3

Jumper Settings for VGA

Jumper JP12
Onboard VGA Enable/Disable

The system board is equipped with an onboard VGA port. If you wish to install a VGA add-in card, set JP12 to Off to disable the onboard VGA.



On: Enabled
(default)



Off:
Disabled

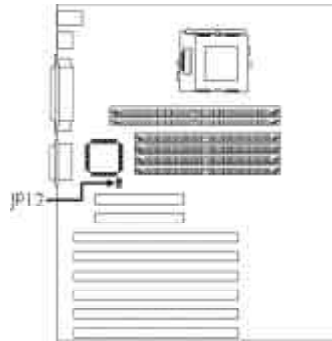

Note:
Jumper JP12 does not exist on the 586ITOX/L system board.

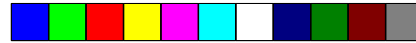

Jumper Settings for Software Power-off

Jumper JP13 Software Power-off Select

Jumper JP13 is used to set the method of powering on/off the PC. The default setting uses the AC power to power on/off the PC. If you wish to use the ATX power supply to software power on/off the PC, set JP13 pins 1 and 2 to On. "Software Power-off" in the Chipset Features Setup must be set accordingly.

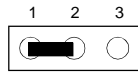
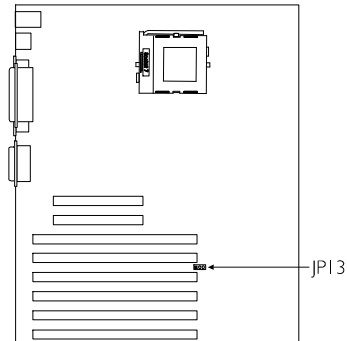

1-2 On: ATX power

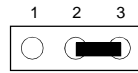

2-3 On: AC power
(default)

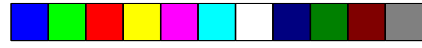

4

586ITOX System Board User's Manual

CHAPTER

4

Desktop Management Interface



Desktop Management Interface (DMI)

The system board comes with a DMI built into the BIOS. DMI, along with the appropriately networked software, is designed to make inventory, maintenance and troubleshooting of computer systems easier. With DMI, a network administrator or MIS engineer can remotely access some information about a particular computer system without physically going to it. Quite often a service call may be unnecessary as the problem can be solved remotely.

The DMI utility in the BIOS automatically records various information about your system configuration. Information about the type and speed of CPU, type and amount of memory for each memory slot, BIOS revision level, types of add-in PCI boards and components, certain revision numbers of hardware installed, etc. are automatically detected and stored in the DMI pool, which is a part of the system board's Plug and Play BIOS. Additional information, such as ISA based peripherals, which may not be automatically detected, can be manually recorded in the DMI pool by using the Add DMI menu. The DMI pool data is then verified or updated whenever the system hardware or setup is altered.

Running the DMI Utility

To run the DMI utility, type: DMICFG.EXE. You can download this utility from <http://www.dfiweb.com> - BIOS & DRIVERS section or <ftp.dfiusa.com> - /pub/DMI directory.

The DMI utility must run in real mode with at least 180K of base memory. Memory managers like HIMEM.SYS (required by Windows) must not be installed. You may do this by using one of the 3 methods listed below.

1. Boot up from a system diskette without the AUTOEXEC.BAT and CONFIG.SYS files,
2. "REM" HIMEM.SYS in the CONFIG.SYS, or
3. Press <F5> during bootup to bypass your AUTOEXEC.BAT and CONFIG.SYS files.

4

586ITOX System Board User's Manual

Using the DMI Utility

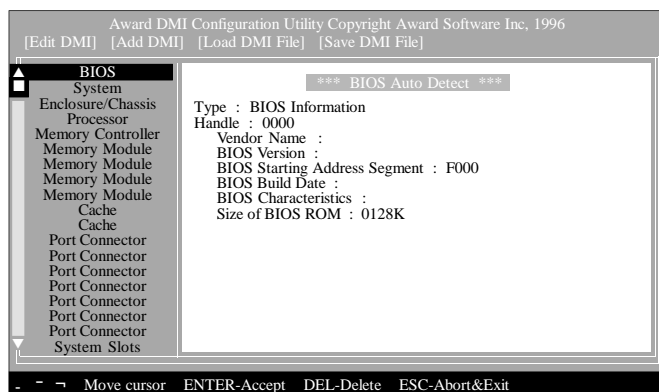

The four menus located on top of the DMI Configuration Utility screen are Edit DMI, Add DMI, Load DMI File and Save DMI File. Use the ← or → (left or right) arrow keys to select a menu from the Menu bar.

On the left side of the screen is a list of the system configuration items. Use the ↑ or ↓ (up or down) arrow keys to select an item.

The commands at the bottom of the screen will allow you to navigate through the various setup menus.

Edit DMI

1. Use the ← or → arrow keys to select the Edit DMI menu.
2. Highlight the item on the left screen that you would like to edit by using the ↑ or ↓ arrow keys, then press <Enter>.
3. The cursor will move to the screen you select allowing you to edit information. The screen will also display the auto-detected information.
4. Press <F10> to update the edited information into the flash ROM.



4

Desktop Management Interface

Add DMI

1. Use the ← or → arrow keys to select the Add DMI menu.
2. Highlight the item on the left screen that you would like to add by using the ↑ or ↓ arrow keys, then press <Enter>.
3. The cursor will move to the screen you select allowing you to enter information about the added item.
4. Press <F10> to save information into the flash ROM.

To view information about the added items, go to the Edit DMI menu.

Load DMI File

1. Use the ← or → arrow keys to select the Load DMI File menu.
2. The following message will appear.

Press [Enter] to select DMI file for load

Press <Enter>.

3. The DMI files will appear on the screen. Select the file you would like to load and press <Enter>.
4. The following message will appear.

Do you want to execute? (Y/N)

Type <Y>. All previous DMI structures will be destroyed and the new file will be saved into the flash ROM.

Save DMI File

1. Use the ← or → arrow keys to select the Save DMI File menu.
2. The following message will appear.

Press [Enter] to select DMI file for save

Press <Enter>.

3. Enter the directory and filename under which you would like the DMI file saved.

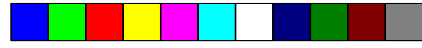

A

586ITOX System Board User's Manual

APPENDIX

A

Installation Instructions



A

Installation Instructions

This chapter summarizes the steps to install the system board into your system unit. It also includes a description of the area in which you must work and directions for memory installation. Before installing the system board, obtain the memory you plan to install. Refer to the System Memory section for the number and type of memory modules needed for the amount of memory you require.

Preparing the Area

Before unpacking the system board, make sure the location you have selected is relatively free of dust and static electricity. Excessive exposure to dust, static electricity, direct sunlight, excessive humidity, extreme cold, and water can damage the operational capabilities of your system board. Avoid placing the unit on surfaces such as carpeted floors. These areas also attract static electricity which can damage some circuits on your system board.

Make sure the power source has a properly grounded, three-pronged socket. It is essential that the power connection be properly grounded for correct functioning of your system board. For further protection, we recommend that you use a surge suppressor. This will protect the system board from damage that may result from a power surge on the electrical line.

Move items that generate magnetic fields away from your system board since magnetic fields can also damage your system board. Once you have selected the ideal location, unpack the system board carefully.

Handling the System Board

It is quite easy to inadvertently damage your system board even before installing it in your system unit. Static electrical discharge can damage computer components without causing any signs of physical damage. You must take extra care in handling the system board to ensure against electrostatic build-up.

Static Electricity Precautions

1. To prevent electrostatic build-up, leave the board in its anti-static bag until you are ready to install it.

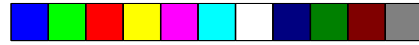

A

586ITOX System Board User's Manual

2. Wear an antistatic wrist strap.
3. Do all preparation work on a static-free surface with the system board components facing up.
4. Hold the system board only by its edges. Be careful not to touch any of the components, contacts or connections, especially gold contacts, on the board.
5. Avoid touching the pins or contacts on all modules and connectors. Hold modules and connectors by their ends.



Warning:

Electrostatic discharge (ESD) can damage your processor, disk drives, add-in boards, and other components. Perform the upgrade instruction procedures described at an ESD workstation only. If such a station is not available, you can provide some ESD protection by wearing an antistatic wrist strap and attaching it to a metal part of the system chassis. If a wrist strap is unavailable, establish and maintain contact with the system chassis throughout any procedures requiring ESD protection.

Installing the System Board

If you are installing the system board, the following outlines the basic installation steps. Before installing the system board into your system unit, you should prepare the tools you will need.

You will need:

- One medium size, flat-bladed screwdriver
 - One medium Phillips screwdriver
 - One needle-nosed pliers
 - One small nutdriver
1. Unlock your system unit. Turn off the power and disconnect all power cords and cables.
 2. Remove the system unit cover. Refer to the manufacturer's instructions if necessary.



A

Installation Instructions

- 3 Detach all connectors from the old system board and remove expansion cards seated in any expansion slots.
- 4 Loosen the screws holding the original system board and remove the board from the system. Save the screws.
- 5 Remove the I/O shield located at the rear of the system unit and replace it with the I/O shield included in the package. Refer to your system chassis manual for instructions on removing and installing the I/O shield.

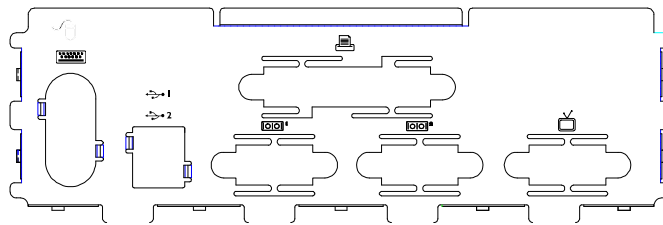

- 6 Remove the system board from its original packing box. Be careful to avoid touching all connectors and pins on the board. Please refer to the handling instructions for proper handling techniques.
- 7 Insert the memory modules into the memory banks on the system board. The quantity and location of the memory modules depends on the memory configuration and type of modules you intend to use.
- 8 Install the processor. Be sure pin 1 of the processor is aligned with pin 1 of the socket.
- 9 Set the corresponding jumpers.
10. Install the prepared system board into the case and replace the screws.
11. Reinstall all cards and connectors and replace the system unit cover. Reconnect all power cords and cables.

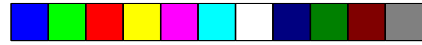

APPENDIX

B

Connecting Cables





B

Connecting Cables

Ports and Connectors

The ATX double deck ports consist of one PS/2 mouse port, one PS/2 keyboard port, two USB ports, a printer port, two serial ports and a VGA port.

Serial Ports

The system board is equipped with two on-board serial ports at locations J4 (COM 2) and J9 (COM 1) of the system board.

The system board is also equipped with two 9-pin connectors (J5-COM2 and J10-COM1) for optional serial port cables. Connect one serial port cable to connector J10 for COM 1 primary serial port and the other serial port cable to connector J5 for the COM 2 secondary serial port.

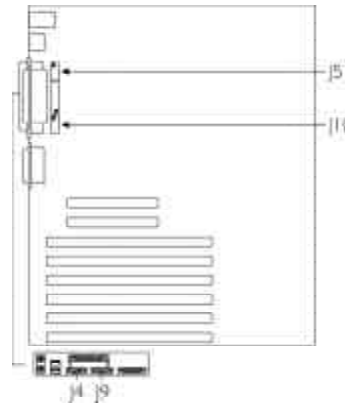

Make sure the colored stripes on the ribbon cables are aligned with pins 1 of connectors J5 and J10. Mount the card-edge bracket to the system chassis.

These built-in serial ports are RS-232C asynchronous communication ports with 16C550A-compatible UARTs that can be used with modems, serial printers, remote display terminals, and other serial devices.

The serial ports use the following system I/O addresses:

Port Configuration	COM1	COM2	COM3	COM4
Serial Port 1	3F8h*	2F8h	3E8h	2E8h
Serial Port 2	3F8h	2F8h*	3E8h	2E8h

* Default

B

Parallel Port

The system board has a standard on-board printer port (J7) for interfacing your PC to a parallel printer. The system board is also equipped with a 25-pin connector (J8) for optional printer port cable. Attach the DB-25 printer port cable to connector J8 on the system board. Make sure the colored stripe on the ribbon cable aligns with pin 1 of connector J8. Use a small nutdriver to mount the cable into a DB-25 cutout in the system chassis. If your printer port cable is attached to a card-edge bracket, connect the cable to connector J8 on the system board and mount the card-edge bracket to the system chassis.

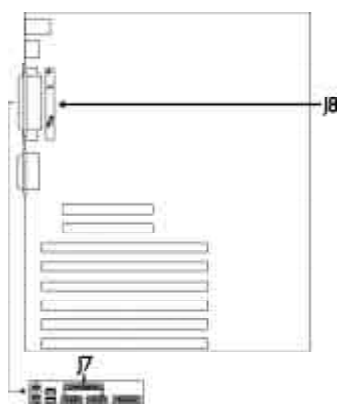

The printer port supports SPP, ECP and EPP modes. You can set the port's mode in the Integrated Peripherals setup of the Award BIOS.

Setting	Function
SPP (Standard Parallel Port)	Allows normal speed operation but in one direction only.
ECP (Extended Capabilities Port)	Allows parallel port to operate in bidirectional mode and at a speed higher than the maximum data transfer rate.
EPP (Enhanced Parallel Port)	Allows bidirectional parallel port operation at maximum speed.

The parallel port on your system board can be set to any of the following system I/O addresses:

I/O Address	3BC-3BE Hex
	378-37A Hex (default)
	278-27A Hex



B

Connecting Cables

Floppy Disk Drive Controller

The system board is equipped with a shrouded floppy disk header that supports two standard floppy disk drives. You can install any 360KB, 720KB, 1.2MB, 1.44MB, or 2.88MB floppy disk drives. To prevent improper floppy cable installation, the shrouded floppy disk header has a keying mechanism. The 34-pin connector on the floppy cable can be placed into the header only if pin 1 of the connector is aligned with pin 1 of the header. Make sure “Onboard FDC Controller” in the Integrated Peripherals Setup of the Award BIOS is enabled.

Connecting the Floppy Disk Cable

1. Install the 34-pin header connector into the shrouded floppy disk header (J11) on the system board. The colored edge of the ribbon should be aligned with pin 1 of connector J11.
2. Install the other 34-pin header connector(s) into the disk drive(s). Align the colored edge of the daisy chained ribbon cable with pin 1 of the drive edge connector(s). The end-most connector should be attached to the drive you want to designate as Drive A.

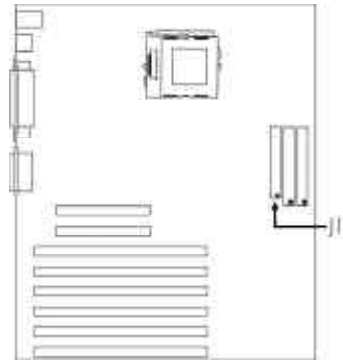

IDE Hard Disk Interface

The system board is equipped with two shrouded PCI IDE headers that will interface four Enhanced IDE (Integrated Drive Electronics) hard disk drives.

Connecting the IDE Hard Disk Interface

To prevent improper IDE cable installation, each shrouded PCI IDE header has a keying mechanism. The 40-pin connector on the IDE cable can be placed into the header only if pin 1 of the connector is aligned with pin 1 of the header.

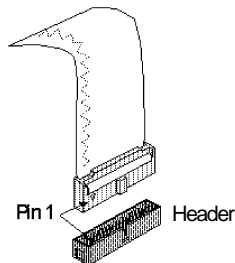
**Note:**

An IDE cable with a standard 40-pin connector (without the keying mechanism) can be installed in the shrouded IDE header. Be extremely careful to match the colored edge of the ribbon with pin 1 of the header.

Connecting the Hard Disk Cable

1. If you are connecting two hard drives, install the 40-pin connector of the IDE cable into the primary shrouded IDE header (connector J15). If you are adding a third or fourth IDE device, install the 40-pin connector of the other IDE cable into the secondary shrouded IDE header (connector J14).
2. Install the other 40-pin header connector(s) into the device with the colored edge of the ribbon cable aligned with pin 1 of the drive edge connector(s).

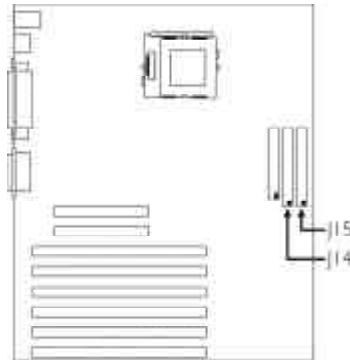
**Note:**

Refer to your disk drive user's manual for information about selecting proper drive switch settings.



B

Connecting Cables

Adding a Second IDE Hard Drive

When using two IDE drives, one must be set as the master and the other as the slave. Follow the instructions provided by the drive manufacturer for setting the jumpers and/or switches on the drives.

We recommend that you use Enhanced IDE or ATA-2 and ATA-3 hard drives be from the same manufacturer. In a few cases, drives from two different manufacturers will not function properly when used together. The problem lies in the hard drives, not the system board.

Important:



If you encountered problems while using an ATAPI CD-ROM drive that is set in Master mode, please set the CD-ROM drive to Slave mode. Some ATAPI CD-ROMs may not be recognized and cannot be used if incorrectly set in Master mode.

Preparing an IDE Drive for Use

IDE disk drives are already low-level formatted, with any bad-track errors entered, when shipped by the drive manufacturer. Do not attempt to do a low-level format or you may cause serious damage to the drive.

To use an IDE drive, you need to enter the drive type (this information is provided by the drive manufacturer) into the system's CMOS setup table. Then run FDISK and FORMAT provided with your operating system. You may also use the "IDE HDD Auto Detection" function which will allow the BIOS to auto detect your hard drive type. Refer to the Chapter 2 - IDE HDD Auto Detection section for details.



Warning:

Do not run FDISK and FORMAT programs on a drive that has already been formatted or you will lose all programs and data stored on the drive.

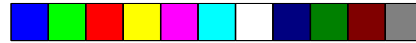

B

VGA Port

The system board is equipped with an on-board VGA port at location J12 of the system board. It is also equipped with a 15-pin connector (J13) for optional VGA port cable.

Connect the VGA port cable to connector J13 on the system board. Make sure the colored stripe on the ribbon cable is aligned with pin 1 of connector J13. Use a small nutdriver to mount the VGA port into a cutout in the system chassis.

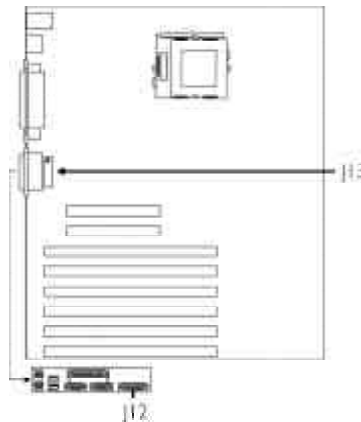

Note:
J12 and J13 does not exist on the 586ITOX/L system board.

Universal Serial Bus Ports

The system board is equipped with two on-board USB ports at location J3. USB allows data exchange between your computer and a wide range of simultaneously accessible external Plug and Play peripherals.

You must have the proper drivers installed in your operating system to use these ports. Refer to your operating system's manual or documentation.

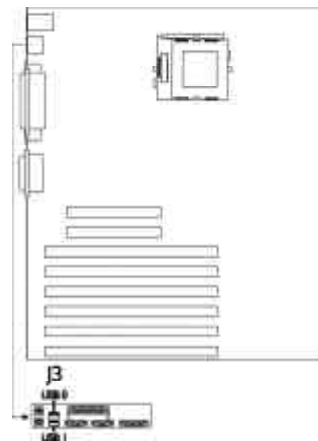

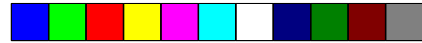

B

..... Connecting Cables

IrDA Connector

The system board is equipped with an IrDA connector for wireless connectivity between your computer and peripheral devices. Connect your IrDA cable to connector J16 on the system board. Refer to “UART2 Mode Select” (Integrated Peripherals setup) in Chapter 2 of this manual for more information.

You must have the proper drivers installed in your operating system to use this connector. Refer to your operating system’s manual or documentation.

Pin	Function
1	IRTX
2	GND
3	IRRX
4	IRR3
5	VCC

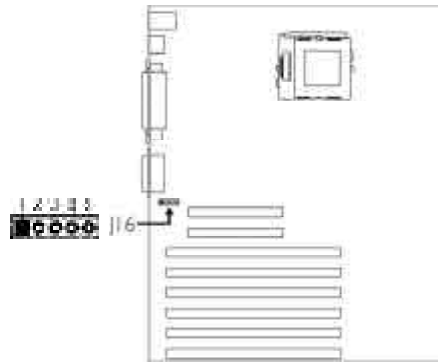

B

CPU Fan Connector

The system board is equipped with a 3-pin fan connector at location J6 of the system board.

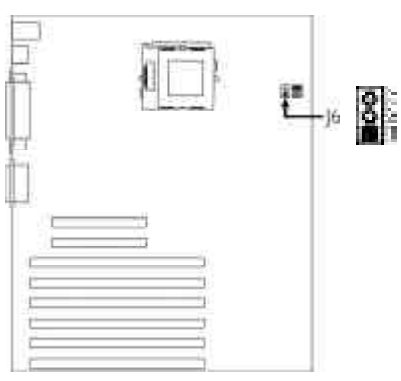

Pin	Function
1	GND
2	+12V
3	NC

ATX Connector

The system board is equipped with an ATX power connector at location J1 of the system board. Using an ATX power supply, you can either shut down your computer by pressing the Power button located on the front bezel of your computer or by executing the Shut Down command under the Windows® 95 operating system. Your system will enter the "soft power off" state.

To power on your system automatically, enable "Resume By Alarm" in the Power Management Setup of the Award BIOS. This will allow you to set the day and time you would like your system to wake up.

An ATX power supply also provides adequate airflow throughout the chassis to prevent overheating the processor.

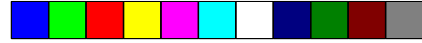

B

..... Connecting Cables

Install the 20-pin ATX power cable connector into location J1 on the system board. The 20-pin connector can be inserted into J1 only if pin 1 of the connector is aligned with pin 1 of J1.

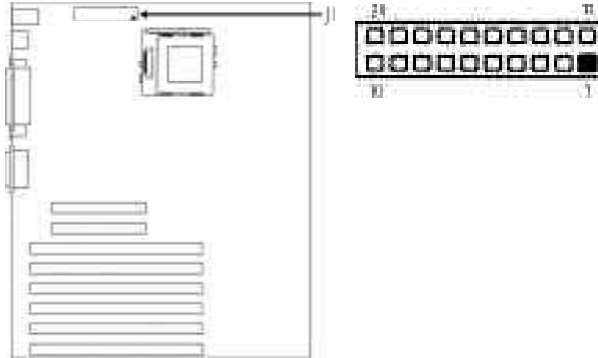

Pin	Function	Pin	Function
1	3.3V	11	3.3V
2	3.3V	12	-12V
3	COM	13	COM
4	5V	14	PS-ON
5	COM	15	COM
6	5V	16	COM
7	COM	17	COM
8	PW-OK	18	-5V
9	5VSB	19	5V
10	12V	20	5V

B

J17 (LEDs and Switches)

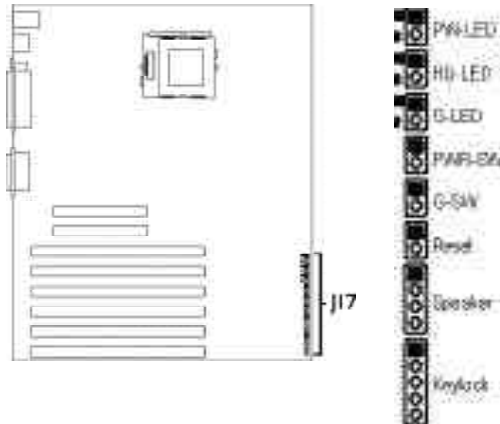

PW-LED (ATX power LED)	Pin 1 Anode Pin 2 Cathode
HD-LED (Primary/Secondary IDE LED)	Pin 1 Anode Pin 2 Cathode
G-LED (Green LED)	Pin 1 Anode Pin 2 Cathode
PWR-SW (ATX power switch)	Pin 1 Signal Pin 2 Ground
G-SW (Green switch)	Pin 1 Signal Pin 2 Ground
RESET (Reset switch)	Pin 1 Signal Pin 2 Ground
SPEAKER (Speaker connector)	Pin 1 SPK OUT Pin 2 N.C. Pin 3 Ground Pin 4 VCC
KEYLOCK (Keylock Connector)	Pin 1 Anode Pin 2 N.C. Pin 3 Cathode Pin 4 Keylock Pin 5 Ground

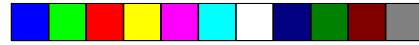

B

..... Connecting Cables

Expansion Slots

The system board is equipped with 1 dedicated PCI slot, 5 dedicated 16-bit ISA slots and 1 shared PCI/ISA slot. All PCI and ISA slots are bus masters.

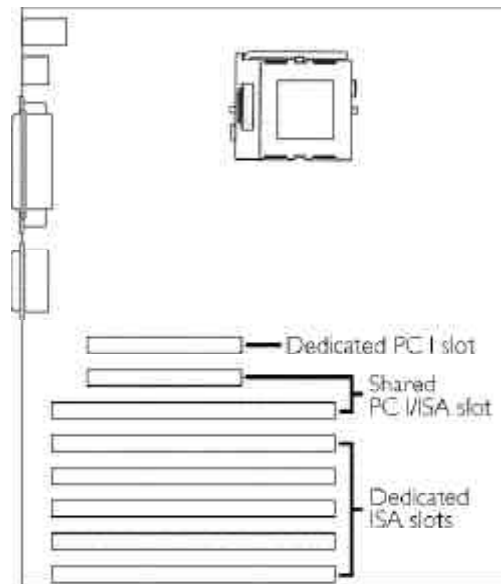



APPENDIX

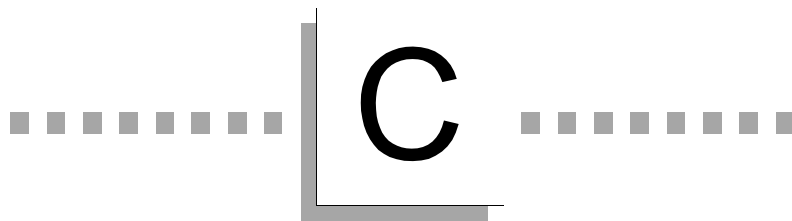

System Board Layout



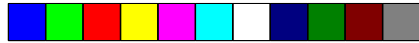

C

System Board Layout

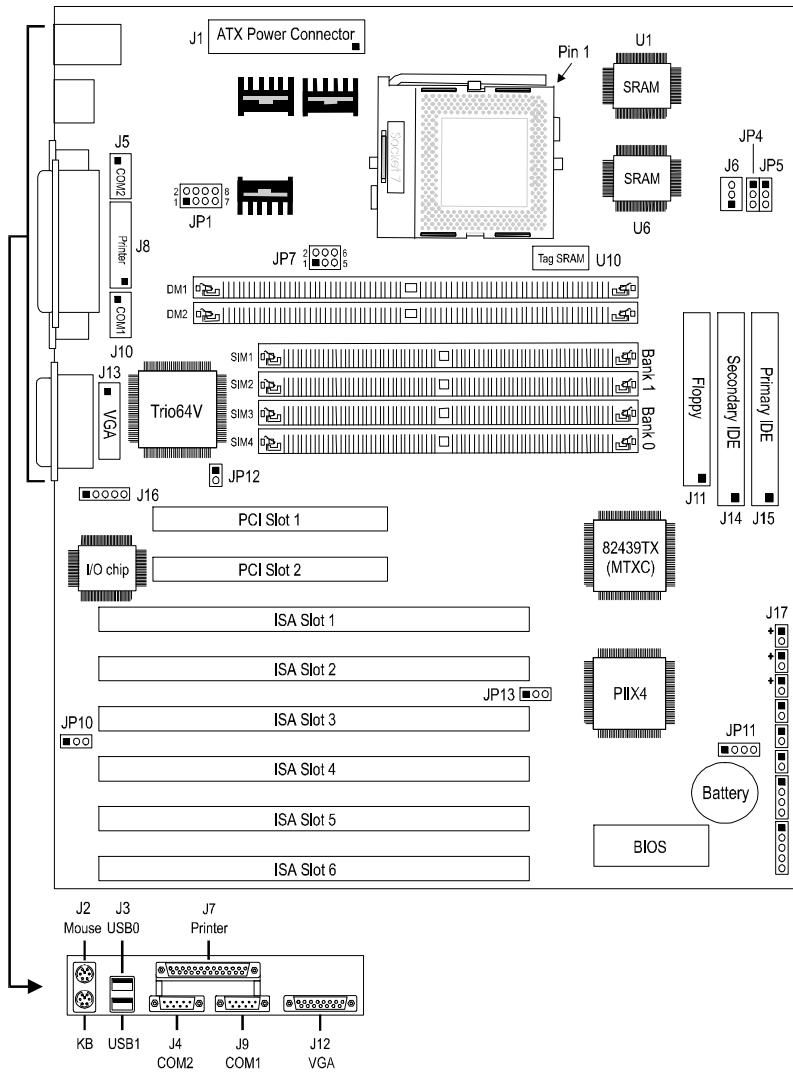

■ square denotes pin 1

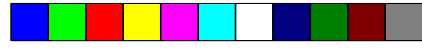

D

586ITOX System Board User's Manual

APPENDIX

D

DIM and SIM Modules



D

..... DIM and SIM Modules

Types of Modules

The following modules have been tested with this board. Most untested brands will work but a few may fail to do so.

SIMM		Brand	Chip Number
4MB	1MBx32/x36	Fujitsu	81C1000A-70
4MB	1MBx32	OKI	M51440A-70
8MB	2MBx32/x36	OKI	M511000B-70
8MB	2MBx32	NEC	424400-60
8MB	2MBx32	Micron	40447-60
8MB	2MBx32/x36	TI	TMS4400DJ-70
8MB	2MBx32	Micron	MT4C4007-70 (EDO)
8MB	2MBx32	Micron	MT4C4007-60 (EDO)
8MB	2MBx32	NEC	4218165-60 (EDO)
16MB	4MBx32/x36	Hitachi	7400AS-70
16MB	4MBx32/x36	Fujitsu	8117400-70
16MB	4MBx32/x36	Mitsubishi	422A06-70
16MB	4MBx32/x36	Hitachi	5117400AS-70
16MB	4MBx32	NEC	4217400-60
16MB	4MBx32	NEC	4217405-70 (EDO)
32MB	8MBx32	NEC	4217405-60 (EDO)
64MB	16MBx32	LGS	71C16100AJ6

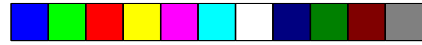

D

586ITOX System Board User's Manual

DIMM	Brand	Chip Number
8MB	Fujitsu	D4516161G5-7JF
8MB	NEC	D4516161G5-7JF
16MB	SEC	KM416S1120AT-G12
16MB	NEC	D4516821G5-A12-7F
16MB	Mitsubishi	M5M4V16S30CTP
32MB	SEC	KM44S4020AT-G12
32MB	SEC	KM44S4020AT-G10
32MB	NEC	D4516821G5-A12-7F
64MB	NEC	D4564841GG5-A10-9JF
128MB	NEC	D4564841GG5-A10-9JF





APPENDIX

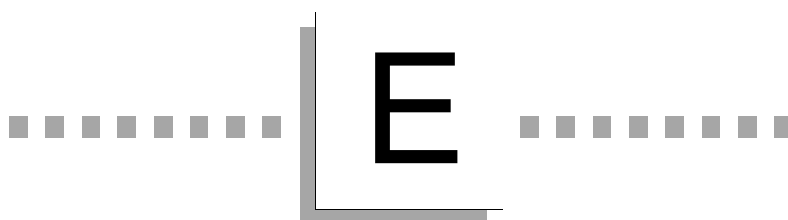

Watchdog Timer



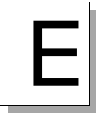
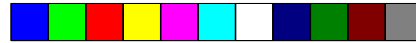

Using the Watchdog Timer Function

The following are the parameters for enabling or disabling the Watchdog Timer function when using the GWBASIC or ASSEMBLY applications.

When enabled, the application accesses read port 443 (HEX).
When disabled, it accesses read port 43 (HEX).

GWBASIC

To enable Watchdog Timer and reload the timer, type:

```
A = INP (&H443)
```

To disable, type:

```
A = INP (&H43)
```

ASSEMBLY

To enable Watchdog Timer and reload the timer, type:

```
MOV  DX, 0443H
IN   AL, DX
```

To disable, type:

```
MOV  DX, 043H
IN   AL, DX
```

Please note that your custom software must regularly reload the timer (by reading that port) before the Watchdog Timer times out. Otherwise, the system will think the machine has already hung-up and will next reboot. Remember to disable it before the software ends/exits.



APPENDIX

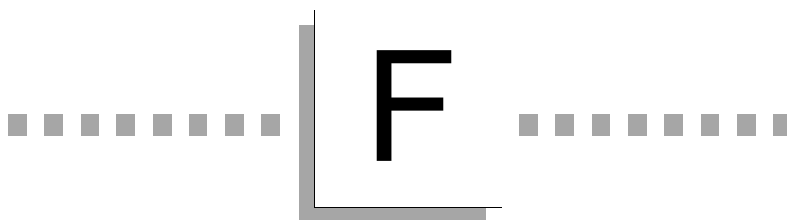

Driver Installation



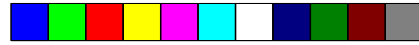

586ITOX System Board User's Manual

The system board comes with an IDE driver diskette. The IDE drivers supported by the system board are: DOS, Windows® 3.1, Windows® 95 and Windows NT® 4.0. To install the IDE drivers, please refer to the "Readme" file contained in the provided diskette.

If you are running Windows® 95 (Win95, Win95+, Win95 OSR1: Windows 95 OEM Service Release 1, Win95 OSR2: Windows 95 OEM Service Release 2.0 or Win95 OSR2.1: Windows 95 OEM Service Release 2.0 plus USB Supplement), you need to run a utility. Please refer to the "Readme" file contained in the provided diskette.

The system board also comes with a VGA driver diskette (586ITOX only). To install the VGA drivers, please refer to the "Readme" file contained in the provided diskette.

All steps or procedures to install software drivers are subject to change without notice as the softwares are occasionally updated. Please refer to the readme files for the latest information.





APPENDIX

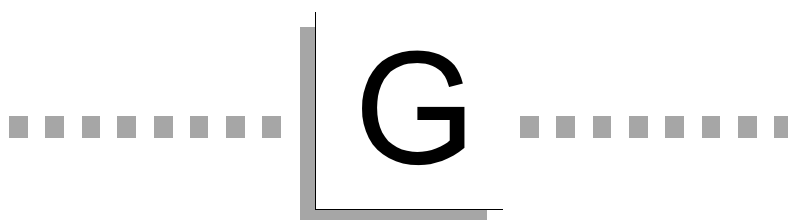

Troubleshooting



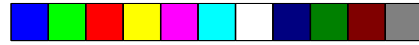

G

Troubleshooting Checklist

This chapter of the manual is designed to help you with problems that you may encounter with your personal computer. To efficiently troubleshoot your system, treat each problem individually. This is to ensure an accurate diagnosis of the problem in case a problem has multiple causes.

Some of the most common things to check when you encounter problems while using your system are listed below.

1. The power switch of each peripheral device is turned on.
2. All cables and power cords are tightly connected.
3. The electrical outlet to which your peripheral devices are connected is working. Test the outlet by plugging in a lamp or other electrical device.
4. The monitor is turned on.
5. The display's brightness and contrast controls are adjusted properly.
6. All add-in boards in the expansion slots are seated securely.
7. Any add-in board you have installed is designed for your system and is set up correctly.

Monitor/Display

If the display screen remains dark after the system is turned on:

1. Make sure that the monitor's power switch is on.
2. Check that one end of the monitor's power cord is properly attached to the monitor and the other end is plugged into a working AC outlet. If necessary, try another outlet.
3. Check that the video input cable is properly attached to the monitor and the system's display adapter.
4. Adjust the brightness of the display by turning the monitor's brightness control knob.



G

..... Troubleshooting

The picture seems to be constantly moving.

1. The monitor has lost its vertical sync. Adjust the monitor's vertical sync.
2. Move away any objects, such as another monitor or fan, that may be creating a magnetic field around the display.
3. Make sure your video card's output frequencies are supported by this monitor.

The screen seems to be constantly wavering.

1. If the monitor is close to another monitor, the adjacent monitor may need to be turned off. Fluorescent lights adjacent to the monitor may also cause screen wavering.

Power Supply

When the computer is turned on, nothing happens.

1. Check that one end of the AC power cord is plugged into a live outlet and the other end properly plugged into the back of the system.
2. Make sure that the voltage selection switch on the back panel is set for the correct type of voltage you are using.
3. The power cord may have a "short" or "open". Inspect the cord and install a new one if necessary.

Floppy Drive

The computer cannot access the floppy drive.

1. The floppy diskette may not be formatted. Format the diskette and try again.
2. The diskette may be write-protected. Use a diskette that is not write-protected.
3. You may be writing to the wrong drive. Check the path statement to make sure you are writing to the targeted drive.

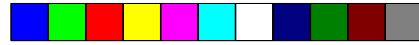

G

586ITOX System Board User's Manual

4. There is not enough space left on the diskette. Use another diskette with adequate storage space.

Hard Drive

Hard disk failure.

1. Make sure the correct drive type for the hard disk drive has been entered in the BIOS.
2. If the system is configured with two hard drives, make sure the bootable (first) hard drive is configured as Master and the second hard drive is configured as Slave. The master hard drive must have an active/bootable partition.

Excessively long formatting period.

1. If your hard drive takes an excessively long period of time to format, it is likely a cable connection problem. However, if your hard drive has a large capacity, it will take a longer time to format.

Parallel Port

The parallel printer doesn't respond when you try to print.

1. Make sure that your printer is turned on and that the printer is on-line.
2. Make sure your software is configured for the right type of printer attached.
3. Verify that the onboard LPT port's I/O address and IRQ settings are configured correctly.
4. Verify that the attached device works by attaching it to a parallel port that is working and configured correctly. If it works, the printer can be assumed to be in good condition. If the printer remains inoperative, replace the printer cable and try again.



G

..... Troubleshooting

Serial Port

The serial device (modem, printer) doesn't output anything or is outputting garbled characters.

1. Make sure that the serial device's power is turned on and that the device is on-line.
2. Verify that the device is plugged into the correct serial port on the rear of the computer.
3. Verify that the attached serial device works by attaching it to a serial port that is working and configured correctly. If the serial device does not work, either the cable or the serial device has a problem. If the serial device works, the problem may be due to the onboard I/O or the address setting.
4. Make sure the COM settings and I/O address are configured correctly.

Keyboard

Nothing happens when a key on the keyboard was pressed.

1. Make sure the keyboard is properly connected.
2. Make sure there are no objects resting on the keyboard and that no keys are pressed during the booting process.

System Board

1. Make sure the add-in card is seated securely in the expansion slot. If the add-in card is loose, power off the system, re-install the card and power up the system.
2. Check the jumper settings to ensure that the jumpers are properly set.
3. Verify that all SIMMs are seated securely into the SIMM sockets.
4. Make sure the SIMMs are in the correct locations.



G

586ITOX System Board User's Manual

5. If the board fails to function, place the board on a flat surface and seat all socketed components. Gently press each component into the socket.
6. If you made changes to the BIOS settings, re-enter setup and load the BIOS defaults.