



G586SPA

Rev. A+
System Board
User's Manual



-D30360318-



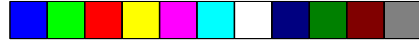

FCC Statement on Class B

This equipment has been tested and found to comply with the limits for a Class B digital device, pursuant to Part 15 of the FCC rules. These limits are designed to provide reasonable protection against harmful interference when the equipment is operated in a residential installation. This equipment generates, uses and can radiate radio frequency energy and, if not installed and used in accordance with the instruction manual, may cause harmful interference to radio communications. However, there is no guarantee that interference will not occur in a particular installation. If this equipment does cause harmful interference to radio or television reception, which can be determined by turning the equipment off and on, the user is encouraged to try to correct the interference by one or more of the following measures:

- Reorient or relocate the receiving antenna.
- Increase the separation between the equipment and the receiver.
- Connect the equipment into an outlet on a circuit different from that to which the receiver is connected.
- Consult the dealer or an experienced radio TV technician for help.

Notice:

1. The changes or modifications not expressly approved by the party responsible for compliance could void the user's authority to operate the equipment.
2. Shielded interface cables must be used in order to comply with the emission limits.

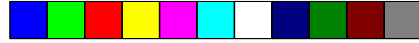
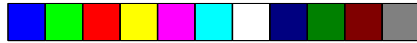

Table of Contents

Chapter 1: Introduction	5
Features and Specifications	6
Package Checklist	8
Chapter 2: Hardware Installation	9
Preparing the Area	9
Handling the System Board	9
Installing the System Board	10
Board Layout	12
System Memory	13
Installing a SIM Module	13
Memory Configuration	14
Cache Memory	15
Jumper Settings for Cache	16
CPU Installation	16
Jumper Settings for CPU	17
Installing Upgrade CPUs	24
Jumper Settings for Display	28
Jumper Settings for PS/2 Mouse	28
Jumper Settings for Password/CMOS Clear	28
Jumper Settings for Internal/External Battery	29
Factory Testing Jumper	29
Built-in Ports	30
Serial Ports	30
PS/2 Mouse Port	31
Parallel Port	31
Floppy Disk Drive Controller	31
IDE Hard Disk Interface	32
Installing Expansion Cards	34
Chapter 3: Software Installation	35
Award BIOS CMOS Setup Utility	35
Standard CMOS Setup	36
BIOS Features Setup	38
Chipset Features Setup	39
Power Management Setup	40
PCI and Onboard I/O Setup	41
Load BIOS Defaults	41



Load Setup Defaults	42
Password Setting	42
IDE HDD Auto Detection	43
HDD Low Level Format	45
Save & Exit Setup	46
Exit Without Saving	46
System Error Report	47
IDE Device Drivers	49

Chapter 4: Troubleshooting Checklist 50

Appendices

Appendix A: Types of SIM Modules	51
Appendix B: Memory and I/O Maps	52
Appendix C: PCI I/O Pin Assignments	54
Appendix D: ISA I/O Pin Assignments	55
Appendix E: System Overview	56
Appendix F: Connector Pin Assignments	58

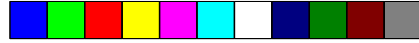

Chapter 1 Introduction

The G586SPA, equipped with a 321-pin Zero Insertion Force (ZIF) CPU socket, is a fast system board supporting Intel Pentium CPUs running at 75MHz, 90MHz, 100MHz, 120MHz, 133MHz, 150MHz and 166MHz frequencies. The G586SPA also supports Cyrix P120+, P133+, P150+, and P166+ CPUs.

The G586SPA can support 2MB to 256MB of system memory using EDO or fast page mode x32 or x36 DRAM. This system board also supports 256KB or 512KB pipeline burst, direct map write-back cache installed on the system board

The G586SPA design is based on the Peripheral Component Interconnect (PCI) and Industry Standard Architecture (ISA) standards. It is equipped with 3 dedicated PCI slots, 3 dedicated 16-bit ISA slots and 1 shared PCI/ISA slot.

The G586SPA board has two bus master PCI IDE connectors. Bus mastering reduces CPU use during disk transfer. This system board is also equipped with two NS16C550A-compatible serial ports, an SPP/ECP/EPP parallel port, a floppy disk drive controller, an IrDA header, one PS/2 mouse port and one PS/2 or AT keyboard connector.

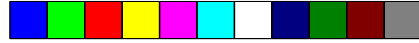

Features and Specifications

Processor

- Intel Pentium™ 75/90/100/120/133/150/166MHz
- Future Pentium™ OverDrive processor
- Cyrix P120+, P133+, P150+, or P166+
 - Linear burst mode supported

Chipset

- SiS chipset
 - SiS5511: PCI/ISA system and cache memory controller
 - SiS5512: PCI local data buffer
 - SiS5513: PCI system I/O

Cache Memory

- Supports 0KB, 256KB (32Kx32x2) or 512KB (64Kx32x2) pipeline burst, direct map write-back cache installed on the system board

System Memory

- Four 72-pin SIMM sockets
- 2MB to 256MB onboard memory
- Uses EDO or fast page mode x32 or x36 DRAM, 60 or 70 ns, 5V

BIOS

- Award BIOS, Windows 95 Plug and Play compatible
- Flash EPROM for easy BIOS upgrades

Energy Efficient Design

- System power management supported
- CPU stopped clock control
- Hardware supports SMI green mode
- Microsoft/Intel APM 1.1 compliant
- External power management switch supported

PCI IDE Interface

- PIO Mode 3 and Mode 4 Enhanced IDE (data transfer rate up to 16.6MB/sec.)
- DMA Mode 2 Bus Master IDE (data transfer rate up to 22.2MB/sec.)

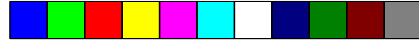

- Bus mastering reduces CPU utilization during disk transfer
- ATAPI IDE CD-ROM supported

Integrated I/O

- UMC super I/O controller
- Two NS16C550A-compatible high speed UARTS
- One SPP/ECP/EPP
- Supports 360KB, 720KB, 1.2MB, 1.44MB, and 2.88MB floppy drives
- IrDA supported

CPU Socket

- 321-pin ZIF socket (Intel Socket 7)

Connectors

- 2 serial ports
- 1 parallel port
- 2 IDE connectors
- 1 floppy connector
- 1 PS/2 mouse port
- 1 mini-DIN-6 PS/2 keyboard connector or AT keyboard connector
- 1 IrDA TX/RX header

Expansion Slots

- 3 dedicated PCI slots
- 3 dedicated 16-bit ISA slots
- 1 shared PC/ISA slot

PCB

- 4 layers, Baby AT form factor
- 25cm (9.84") x 22cm (8.66")

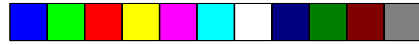

Package Checklist

The G586SPA package contains the following items:

- The G586SPA system board
- The G586SPA user's manual
- One 40-pin IDE hard disk cable
- One 34-pin floppy disk drive cable
- One 25-pin printer port cable for chassis mounting
- One card-edge bracket with serial and mouse port cables
- One IDE driver diskette

If any of these items are missing or damaged, please contact your dealer or sales representative for assistance.

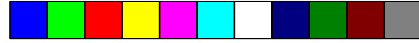

Chapter 2 Hardware Installation

This chapter summarizes the steps to install the G586SPA system board into your system unit. It also includes a description of the area in which you must work and directions for memory installation. Before installing the system board, obtain the memory you plan to install. Please refer to the memory chart on pages 14 and 15 for the number and type of SIM modules needed for the amount of memory you require.

Preparing the Area

Before unpacking the system board, make sure the location you have selected is relatively free of dust and static electricity. Excessive exposure to dust, static electricity, direct sunlight, excessive humidity, extreme cold, and water can damage the operational capabilities of your system board. Avoid placing the unit on surfaces such as carpeted floors. These areas attract static electricity which can damage circuits on your system board.

Make sure the power source has a properly grounded, three-pronged socket. It is essential that the power connection be properly grounded for correct functioning of your system board. For further protection, we recommend that you use a surge suppressor. This will protect the system board from damage that may result from a power surge on the electrical line.

Move items that generate magnetic fields away from your system board since magnetic fields can also damage your system board. Once you have selected the ideal location, unpack the G586SPA system board carefully.

Handling the System Board

It is quite easy to inadvertently damage your system board even before installing it in your system unit. Static electrical discharge can damage computer components without causing any signs of physical damage. You must take extra care in handling the system board to ensure against electrostatic build-up.

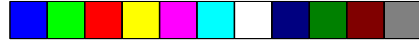

Static Electricity Precautions

1. To prevent electrostatic build-up, leave the board in its anti-static bag until you are ready to install it.
2. Wear an antistatic wrist strap.
3. Do all preparation work on a static-free surface with system board components facing up.
4. Hold the system board only by its edges. Be careful not to touch any of the components, contacts or connections, especially gold contacts, on the board.
5. Avoid touching the pins or contacts on all modules and connectors. Hold modules and connectors by their ends.

Warning:

Electrostatic discharge (ESD) can damage your processor, disk drives, add-in boards, and other components. Perform the upgrade instruction procedures described at an ESD workstation only. If such a station is not available, you can provide some ESD protection by wearing an anti-static wrist strap and attaching it to a metal part of the system chassis. If a wrist strap is unavailable, establish and maintain contact with the system chassis throughout any procedures requiring ESD protection.

Installing the System Board

If you are installing the G586SPA system board, the following outlines the basic installation steps. Before installing the system board into your system unit, you should prepare the tools you will need.

You will need:

- One medium size, flat-bladed screwdriver
- One medium Phillips screwdriver
- One needle-nosed pliers
- One nutdriver

1. Unlock your system unit. Turn off the power and disconnect all power cords and cables.

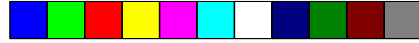

2. Remove the system unit cover. Refer to the manufacturer's instructions if necessary.
3. Remove expansion cards seated in any of the expansion slots and detach all connectors from the old system board.
4. Loosen the screws holding the original system board and remove the board from the system. Save the screws.
5. Remove the G586SPA from its original packing box. Be careful to avoid touching all connectors and pins on the board. Please refer to the handling instructions on pages 9-10 for proper handling techniques.
6. Insert the SIMMs into the SIMM banks on the G586SPA. The quantity and location of the SIMMs depends on the memory configuration and type of modules you intend to use.
7. Install the CPU. Be sure pin 1 of the CPU is aligned with pin 1 of the socket.
8. Set the corresponding jumpers.
9. Install the prepared G586SPA system board into the case and replace the screws.
10. Reinstall all cards and connectors and replace the system unit cover. Reconnect all power cords and cables.



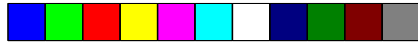

Board Layout

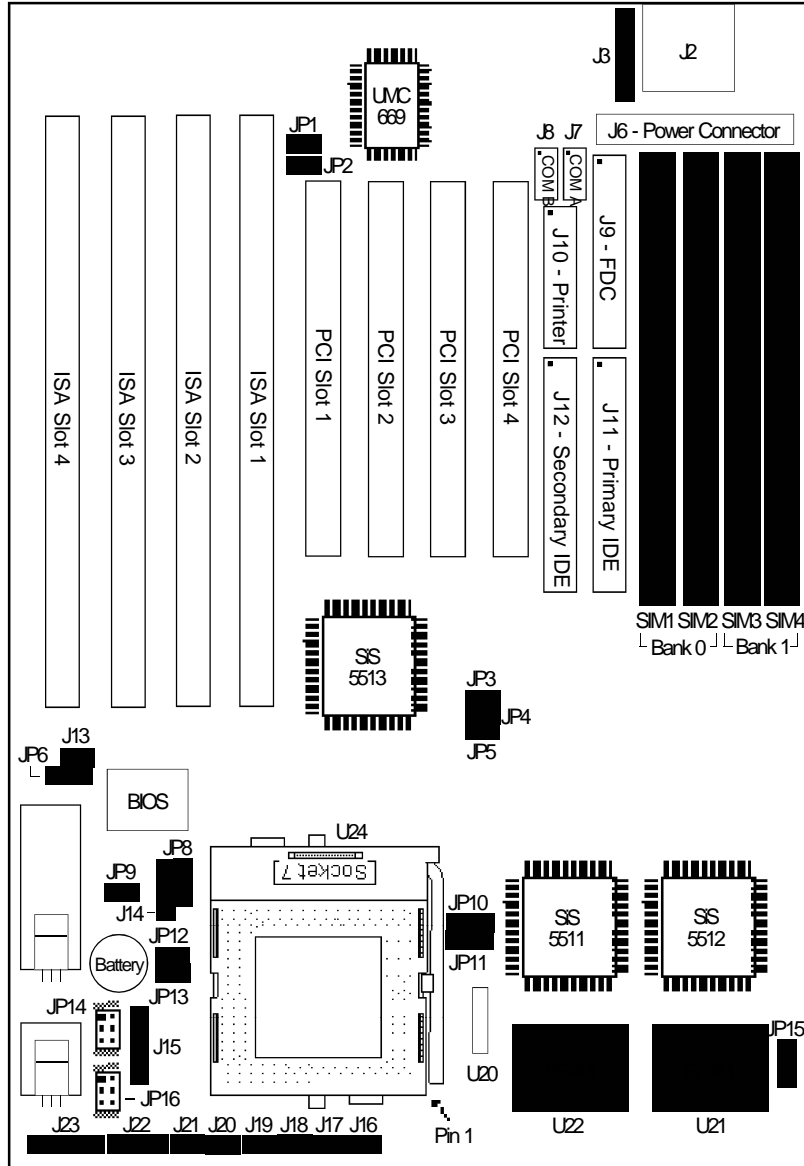

■ Pin 1

System Memory

The G586SPA system board can support 2MB to 256MB of memory using 72-pin SIMMs (Single In-line Memory Module). A SIM module consists of several RAM chips soldered onto a small circuit board.

The SIM sockets are divided into two banks on the system board. Each bank consists of 2 SIMM sockets. You will need 1 to 4 pieces of SIM modules, depending on the amount of memory you intend to install.

The G586SPA system board uses 256KBx32/36, 512KBx32/36, 1MBx32/36, 2MBx32/36, 4MBx32/36, 8MBx32/36 and 16MBx32/36 SIMM modules. Refer to page 12 for the locations of the SIMM sockets.

Installing a SIM Module

A SIM module simply snaps into a socket on the system board. Pin 1 of the SIM module must correspond with Pin 1 of the socket.

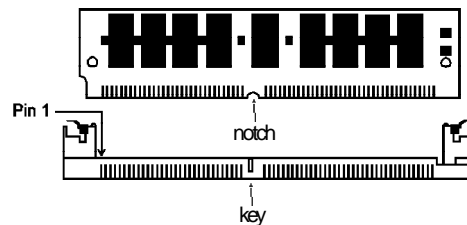

1. Position the SIMM above the socket with the “notch” in the module aligned with the “key” on the socket.
2. Seat the module at a 45° angle into the bank. Make sure it is completely seated. Tilt the module upright until it locks in place in the socket.



Memory Configuration

The table below summarizes the bank locations and modules needed for the corresponding memory sizes.

Memory Size	Bank0		Bank1	
	SIMM1	SIMM2	SIMM3	SIMM4
32-bit mode				
4MB	1Mx32/x36	—	—	—
8MB	2Mx32/x36	—	—	—
16MB	4Mx32/x36	—	—	—
32MB	8Mx32/x36	—	—	—
64MB	16Mx32/x36	—	—	—
64-bit mode				
2MB	256Kx32/x36	256Kx32/x36	—	—
4MB	256Kx32/x36	256Kx32/x36	256Kx32/x36	256Kx32/x36
4MB	512Kx32/x36	512Kx32/x36	—	—
6MB	512Kx32/x36	512Kx32/x36	256Kx32/x36	256Kx32/x36
8MB	512Kx32/x36	512Kx32/x36	512Kx32/x36	512Kx32/x36
8MB	1Mx32/x36	1Mx32/x36	—	—
10MB	1Mx32/x36	1Mx32/x36	256Kx32/x36	256Kx32/x36
12MB	1Mx32/x36	1Mx32/x36	512Kx32/x36	512Kx32/x36
16MB	1Mx32/x36	1Mx32/x36	1Mx32/x36	1Mx32/x36
16MB	2Mx32/x36	2Mx32/x36	—	—
18MB	2Mx32/x36	2Mx32/x36	256Kx32/x36	256Kx32/x36
20MB	2Mx32/x36	2Mx32/x36	512Kx32/x36	512Kx32/x36
24MB	2Mx32/x36	2Mx32/x36	1Mx32/x36	1Mx32/x36
32MB	2Mx32/x36	2Mx32/x36	2Mx32/x36	2Mx32/x36
32MB	4Mx32/x36	4Mx32/x36	—	—
34MB	4Mx32/x36	4Mx32/x36	256Kx32/x36	256Kx32/x36
36MB	4Mx32/x36	4Mx32/x36	512Kx32/x36	512Kx32/x36
40MB	4Mx32/x36	4Mx32/x36	1Mx32/x36	1Mx32/x36
48MB	4Mx32/x36	4Mx32/x36	2Mx32/x36	2Mx32/x36

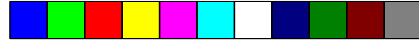

Memory Size	Bank0		Bank1	
	SIMM1	SIMM2	SIMM3	SIMM4
64MB	4Mx32/x36	4Mx32/x36	4Mx32/x36	4Mx32/x36
64MB	8Mx32/x36	8Mx32/x36	—	—
66MB	8Mx32/x36	8Mx32/x36	256Kx32/x36	256Kx32/x36
68MB	8Mx32/x36	8Mx32/x36	512Kx32/x36	512Kx32/x36
72MB	8Mx32/x36	8Mx32/x36	1Mx32/x36	1Mx32/x36
80MB	8Mx32/x36	8Mx32/x36	2Mx32/x36	2Mx32/x36
96MB	8Mx32/x36	8Mx32/x36	4Mx32/x36	4Mx32/x36
128MB	8Mx32/x36	8Mx32/x36	8Mx32/x36	8Mx32/x36
128MB	16Mx32/x36	16Mx32/x36	—	—
130MB	16Mx32/x36	16Mx32/x36	256Kx32/x36	256Kx32/x36
132MB	16Mx32/x36	16Mx32/x36	512Kx32/x36	512Kx32/x36
136MB	16Mx32/x36	16Mx32/x36	1Mx32/x36	1Mx32/x36
144MB	16Mx32/x36	16Mx32/x36	2Mx32/x36	2Mx32/x36
160MB	16Mx32/x36	16Mx32/x36	4Mx32/x36	4Mx32/x36
192MB	16Mx32/x36	16Mx32/x36	8Mx32/x36	8Mx32/x36
256MB	16Mx32/x36	16Mx32/x36	16Mx32/x36	16Mx32/x36

Cache Memory

The G586SPA system board supports 256KB or 512KB pipeline burst, direct map write-back cache installed at locations U21 and U22 of the system board. Regardless of the amount of cache memory installed, one 8KBx8, 16KBx8 or 32KBx8 is needed for tag RAM (U20) to store the cacheable addresses. Refer to page 12 for the locations of the SRAMs.

Cache Size	Data SRAM	Tag SRAM	Cacheable Range	
			8 Tag Bits	7 Tag Bits 1 Dirty Bit
256KB 512KB	32KBx32x2 64KBx32x2	8KBx8x1 16/32KBx8x1	64MB 128MB	32MB 64MB

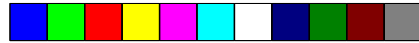

Note:

You can change the cacheable range of the cache size installed using the "L2 (WB) Tag Bit Length" option in the Chipset Features Setup of the Award BIOS utility.

Jumper Settings for Cache

Jumper JP10

Cache Memory Select

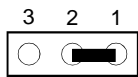

1-2 On: 256KB
(Default)

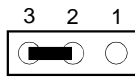

2-3 On: 512KB

Jumper JP11

L1 Cache Mode

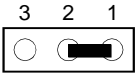

1-2 On: Write-back
(Default)

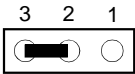

2-3 On: Write-through

Note:

Everytime you reset JP11, the "L1 Cache Update Mode" option in the Chipset Features Setup of the Award BIOS utility must be changed accordingly.

CPU Installation

The G586SPA allows for easy installation of CPUs. Make sure all jumpers are set correctly before applying power or you may damage the CPU or system board. Use the needle-nosed plier to move the jumpers as necessary. Please see the jumper settings on the next page.

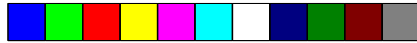

Jumper Settings for CPUs

Intel 75MHz CPU: External Speed: 50MHz
Frequency Ratio: 1.5x

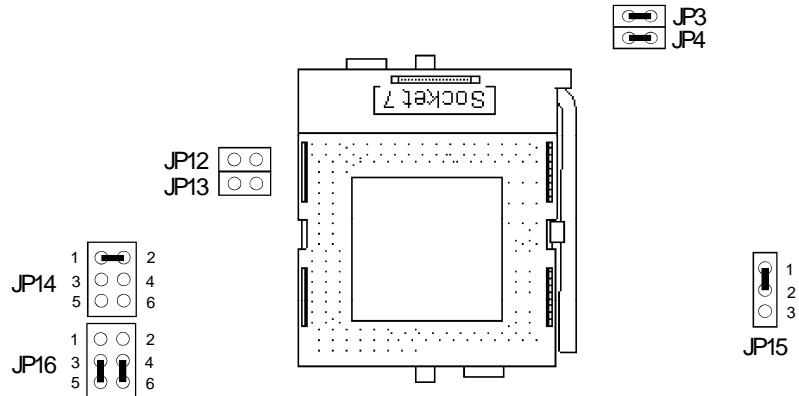

Intel 90MHz CPU: External Speed: 60MHz
Frequency Ratio: 1.5x

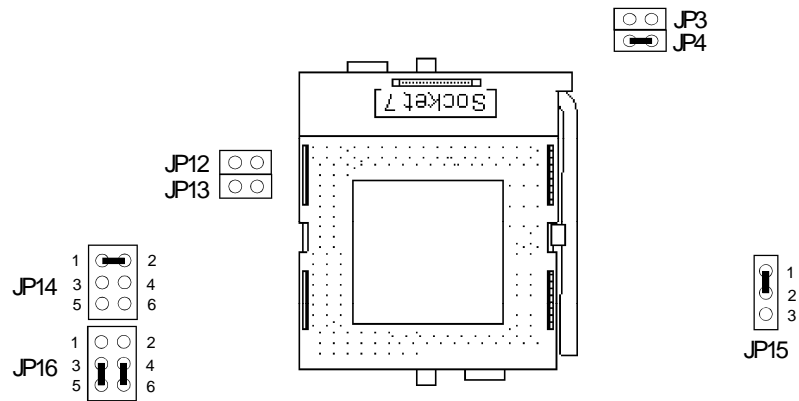

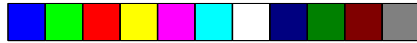

Intel 100MHz CPU*: External Speed: 66MHz
Frequency Ratio: 1.5x

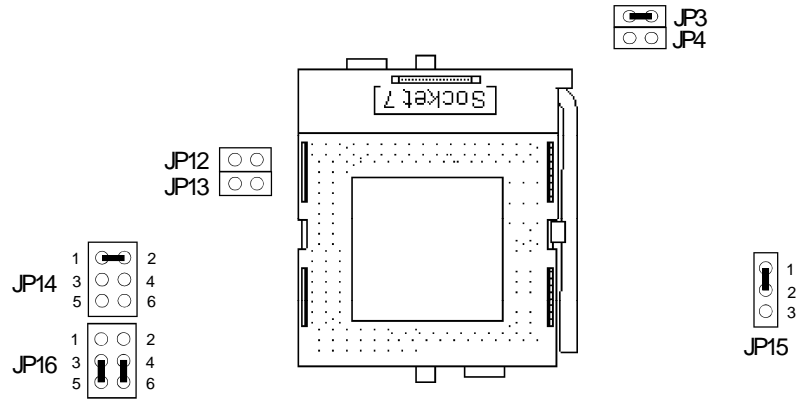

Intel 120MHz CPU: External Speed: 60MHz
Frequency Ratio: 2x

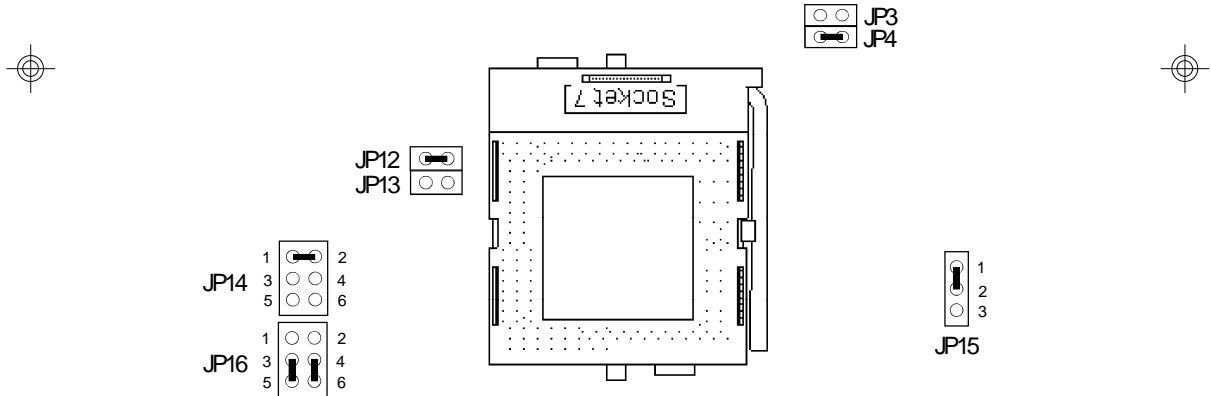

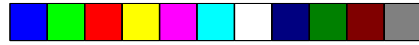

Intel 133MHz CPU: External Speed: 66MHz
Frequency Ratio: 2x

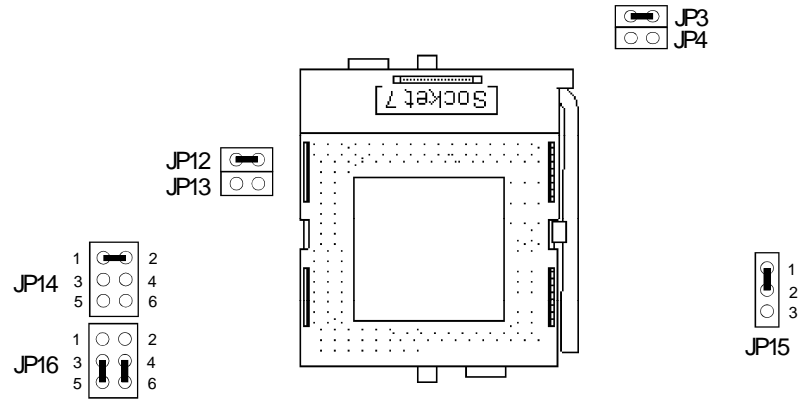

Intel 150MHz CPU: External Speed: 60MHz
Frequency Ratio: 2.5x

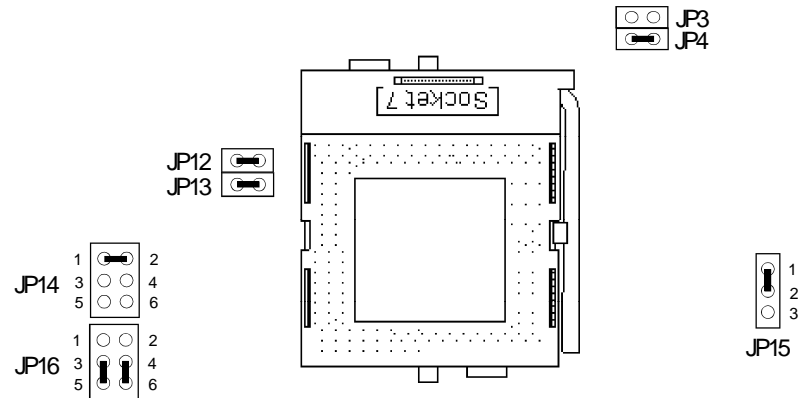

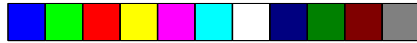

Intel 166MHz CPU: External Speed: 66MHz
Frequency Ratio: 2.5x

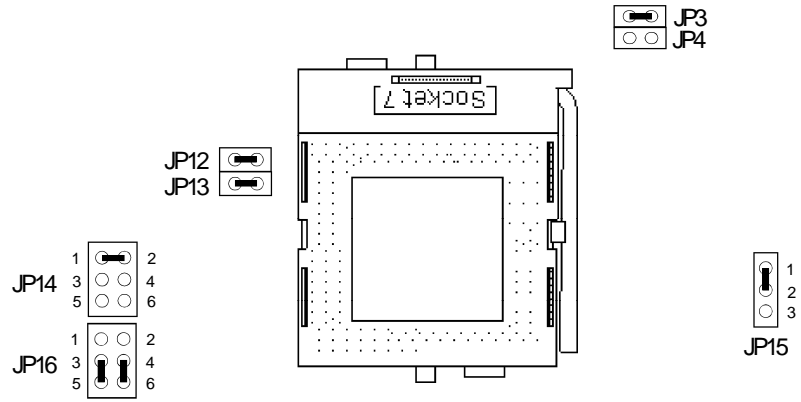

Intel 180MHz CPU: External Speed: 60MHz
Frequency Ratio: 3x

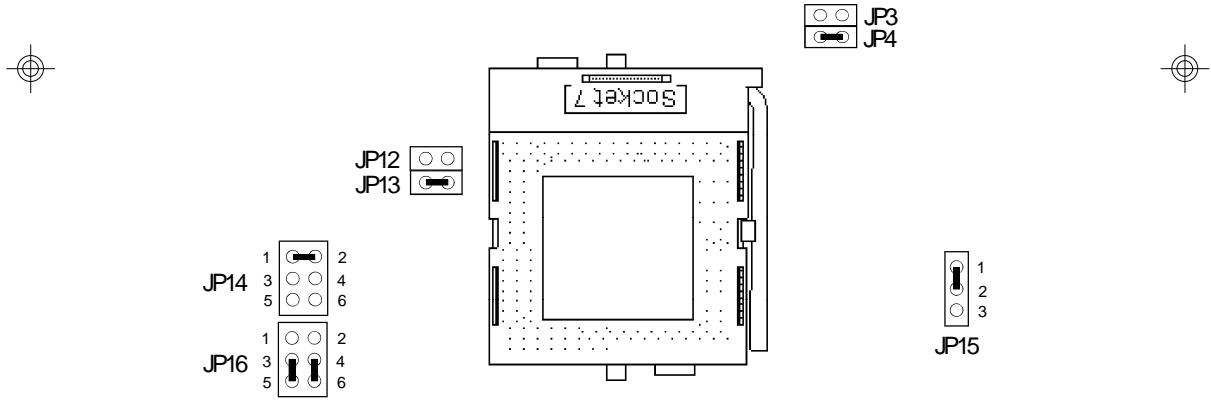

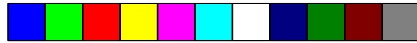

Intel 200MHz CPU: External Speed: 66MHz
Frequency Ratio: 3x

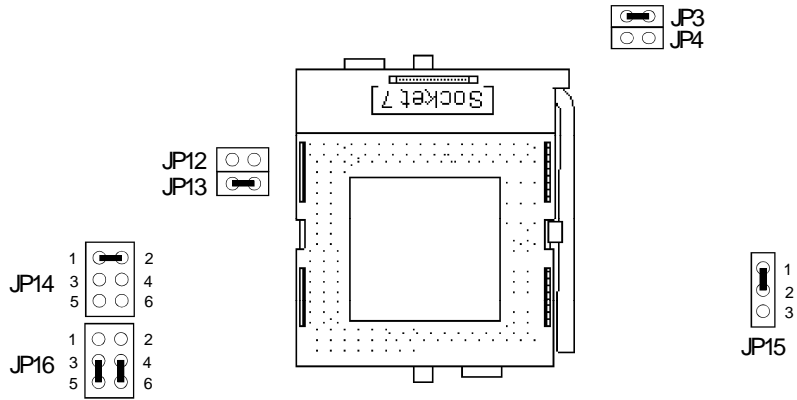

Cyrix P120+ CPU: External Speed: 50MHz
Frequency Ratio: 2x

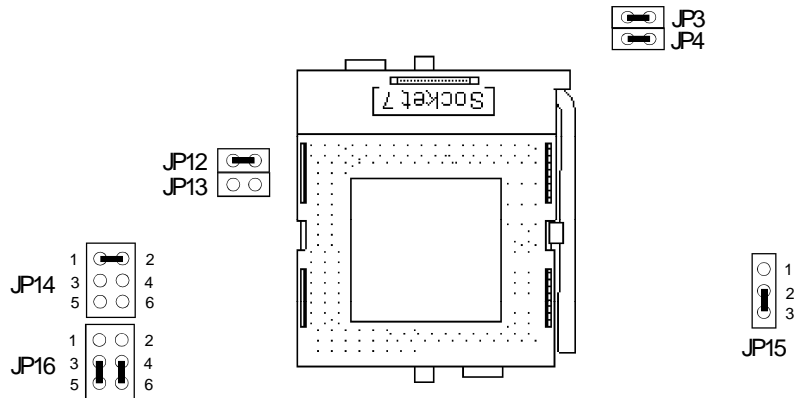

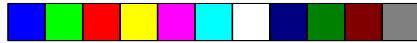

Cyrix P133+ CPU: External Speed: 55MHz
Frequency Ratio: 2x

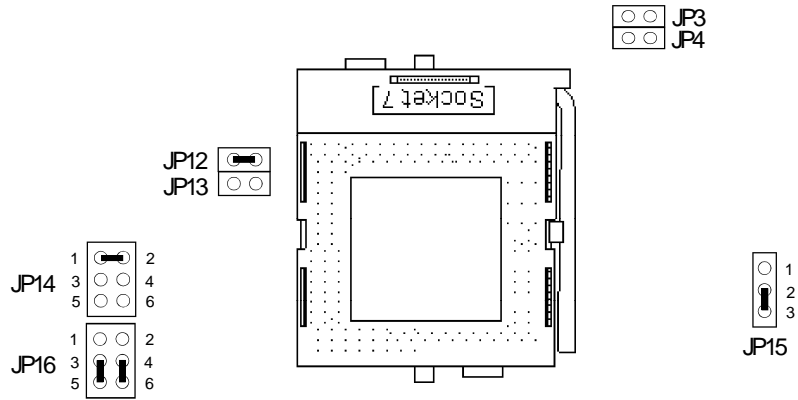

Cyrix P150+ CPU: External Speed: 60MHz
Frequency Ratio: 2x

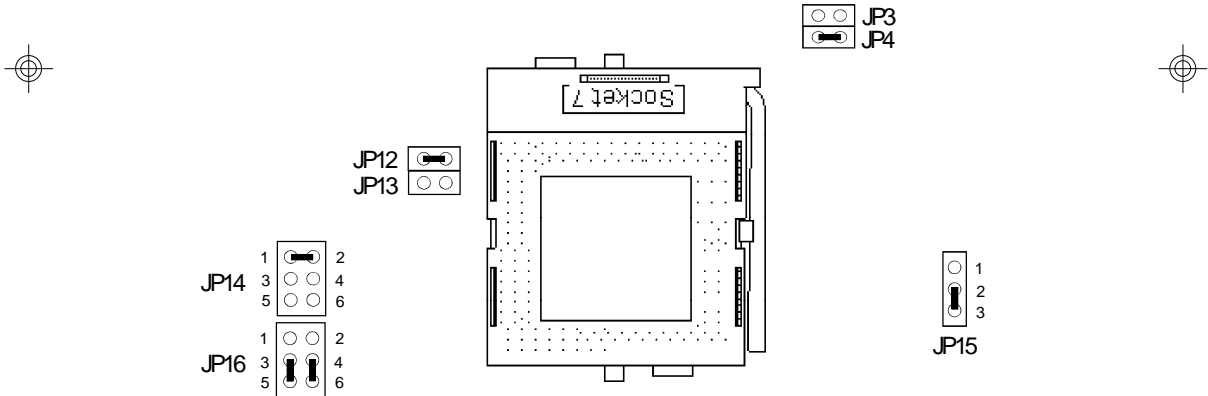



Cyrix P166+ CPU: External Speed: 66MHz
Frequency Ratio: 2x

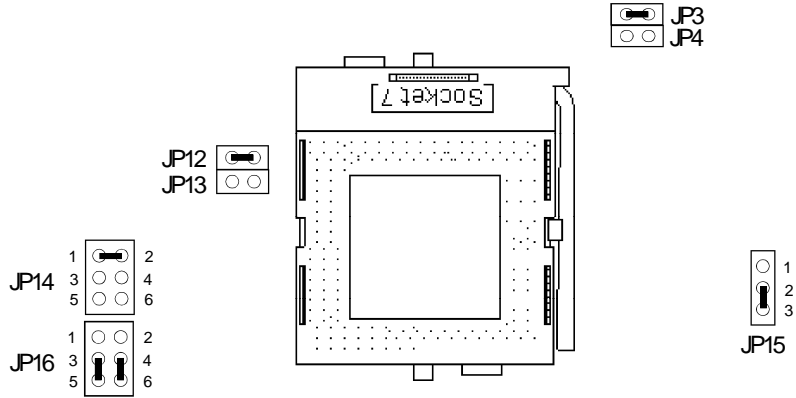

Jumpers JP14 and JP16
Future Low-Voltage CPUs (2.xV + 3.3V)

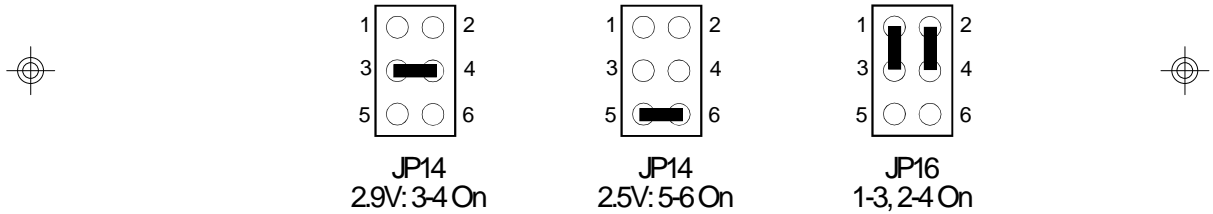

Jumper JP5
PCI Bus Clock

The default setting of Jumper JP5 is Off, CPU bus clock/2. This setting will divide your CPU's external speed into 2. However, if you are using a 75MHz CPU, you can set JP5 to On, 32MHz, which is faster than half of its external speed.



On: 32MHz



Off: CPU bus clock/2
(Default)



Installing Upgrade CPUs

The G586SPA is equipped with a 321-pin Zero Insertion Force (ZIF) socket at location U24 of the system board. Refer to page 12 for the location of the ZIF socket. This socket is designed for easy removal of an old CPU and easy insertion of an upgrade CPU. The socket allows you to carefully place the new CPU into its position. If you need to apply excessive force to insert the CPU, you are not installing the CPU correctly.

Warning:

Open the socket only if you are actually installing a CPU. The warranty on the original CPU will be voided if the S/N seal is broken.

Before proceeding with the upgrade, take note of the following. The microprocessor and heat sink may be hot if the system has been running. To avoid the possibility of a burn, power the system off and let the processor and heat sink cool for 15 minutes.

The 321-pin ZIF socket consists of five rows of pin holes on each side. To prevent improper CPU installation, the ZIF socket has a Plug/Keying mechanism. Several holes in the socket are plugged so that the CPU will go in only one way. If you cannot easily insert the CPU, verify that pin 1 of the CPU is aligned with pin 1 of the socket.

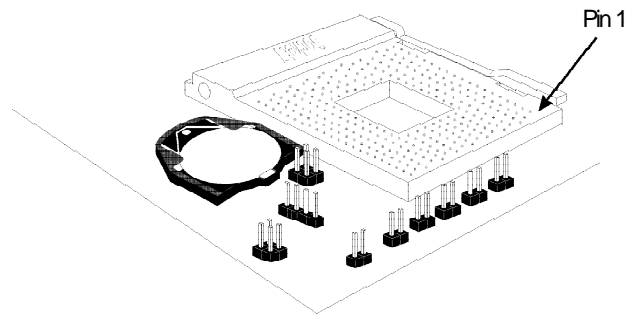

Zero Insertion Force (ZIF) Socket

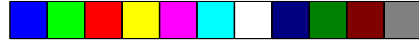

To install an upgrade CPU, do the following.

1. Make sure the handle on the side of the ZIF socket is up. To raise the handle, push it down, slightly pull it out to the side, then raise it as far as it will go. It may be necessary to initially apply a small amount of sideways force to free the handle from its retaining "tab." Once clear of the "tab," the handle will open relatively easily. The top plate will slide back. Do not use screwdrivers or other tools to open the socket, or you may damage the system or socket.

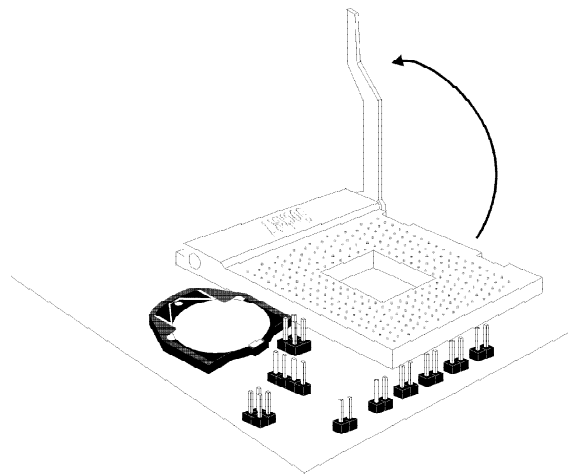

Lifting the Handle

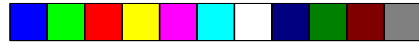

2. Once the lever is completely up, remove the old CPU carefully by lifting it straight out of the socket. You are now ready to insert the new CPU.

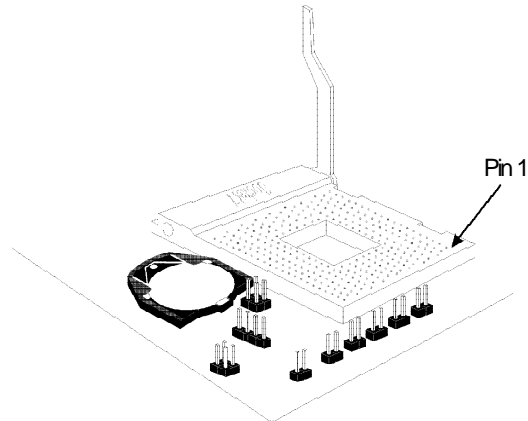

3. Position the CPU above the ZIF socket. Make sure pin 1 of the CPU is aligned with pin 1 of the socket. Lower the chip until the pins are inserted properly in their corresponding holes. Remember that very little force is needed to install the CPU. If the CPU is not easily inserted, verify whether or not pin 1 of the CPU is aligned with pin 1 of the socket. Applying too much pressure can damage the CPU or the socket.

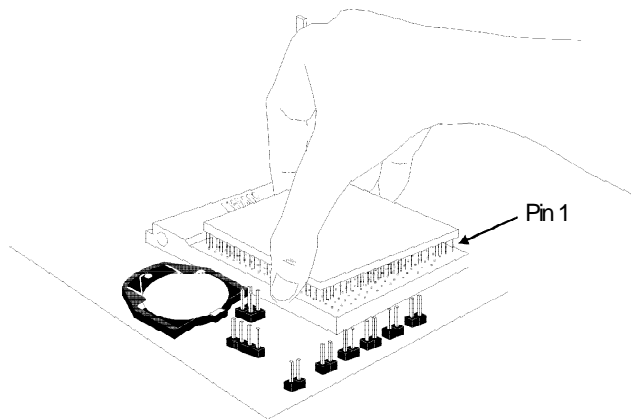

Positioning the CPU Above the ZIF Socket



4. Push the handle down until the handle locks into place. The top plate will slide forward. You will feel some resistance as the pressure starts to secure the CPU in the socket. This is normal and will not damage the CPU. However, if the handle is not completely closed, damage to the CPU and/or system board may result.

Clearance Requirements

Your CPU comes with a heat sink mounted on top. To maintain proper airflow once the upgrade is installed on the system board, the CPU and heatsink require certain space clearances.

The clearance above the CPU's fan/heat sink must be at least 0.4 inches. The clearance on at least 3 of 4 sides of the CPU must be at least 0.2 inches. The cables (for floppy drive, hard drive, CD-ROM, etc.) must be routed clear of the CPU and its airspace.

Fan Exhaust

The CPU must be kept cool by using a fan with heatsink. The temperature of the air entering the fan/heatsink cannot exceed 45°C (113°F). The ambient or room temperature must be below 37°C (99°F).

In order to provide proper airflow to the CPU, all movable obstructions (power supply cables, cards, floppy disk cables) must be clear of the CPU fan/heatsink component in accordance with the space clearance discussed in the Clearance Requirements section of this manual.





Jumper Settings for Display

Jumper JP1
Display Type Select



On: Color
(Default)



Off: Mono

Jumper Settings for PS/2 Mouse

Jumper JP2
PS/2 Mouse

The G586SPA package includes a card-edge bracket with serial and mouse ports. If you set Jumper JP2 to “Enabled,” make sure you connect the PS/2 mouse port to connector J3.



On: Enabled
(Default)



Off: Disabled

Jumper Settings for Password/CMOS Clear

Jumper JP8
Password/CMOS Clear

If, for some reason, the CMOS becomes corrupted, the system can be reconfigured with the default values stored in the ROM BIOS. To load the default values, switch off your computer and remove the cover. Touch the power supply box to discharge any static electric buildup in your body. Set JP8 pins 2 and 3 to On for approximately 5 seconds, then return to the default position (pins 1 and 2 On). Put the cover back and power up your system.

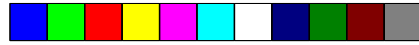

If you set a password in the “Password Setting” option and forget your password, power off your system and set JP8 pins 2 and 3 to On to clear the password stored in your CMOS. Now power on your system. After your system has detected the floppy or hard drive, turn it off again and set JP8 pins 1 and 2 to On.

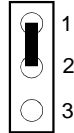

1-2 On: Normal
(Default)

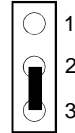

2-3 On: Password/
CMOS clear

Jumper Settings for Internal/External Battery

Jumper JP9

Internal/External Battery Select

The G586SPA comes with an internal lithium battery. Set JP9 to On to use the internal battery. If JP9 is set to Off, you must connect an external battery to connector J14 or your system will lose its CMOS settings when powered off.



On: Internal battery



Off: External battery
(Default)

Factory Testing Jumper

The jumper below is for factory testing only and should always be set to its default configuration. Reconfiguring this jumper will cause problems with your system board.

JP6: 1-2 On (29F010/29EE010)
2-3 On (28F010)

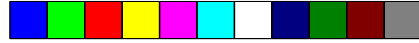

Built-in Ports

The G586SPA system board is equipped with two serial ports, one parallel printer port, one FDD connector, two IDE hard disk shrouded headers and one PS/2 mouse connector. Refer to page 12 for the locations of the built-in connectors and pin 1 of those connectors.

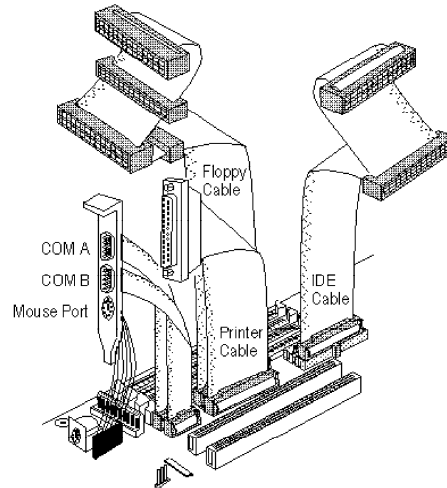

Serial Ports

The built-in serial ports are RS-232C asynchronous communication ports with 16C550A-compatible UARTs that can be used with modems, serial printers, remote display terminals, and other serial devices. They use the following system I/O addresses:

Port Configuration	I/O Address
COMA	3F8h
COMB	2F8h

Connecting the Serial Ports

Two DB-9P serial port cables are provided with the system board. They are mounted on a card-edge bracket along with the PS/2 mouse cable. The upper serial port cable should be used for the COM A primary serial port; connect it to connector J7 on the system board. The lower



serial port cable should be used for the COM B secondary serial port; connect it to connector J8 on the system board. Make sure the colored stripes on the ribbon cables are aligned with pin 1 of connectors J7 and J8. Mount the card-edge bracket to the system chassis.

PS/2 Mouse Port

The PS/2 mouse port is a 6-pin connector on the system board. Attach the 6-pin mouse port cable, which is mounted on the card-edge bracket, to connector J3. Make sure the brown wire on the PS/2 mouse connector is aligned with pin 1 of connector J3. Mount the card-edge bracket to the system chassis.

Parallel Port

The G586SPA system board has a standard connector for interfacing your PC to a parallel printer. The parallel port on your system board can be set to any of the following system I/O addresses:

I/O Address: 3BC-3BE Hex
378-37A Hex (default)
278-27A Hex

Connecting the Parallel Printer Port

Attach the DB-25S printer port cable, which came with the system board, to connector J10 on the G586SPA system board. Make sure the colored stripe on the ribbon cable aligns with pin 1 of connector J10. Use a small nutdriver to mount the cable into a DB-25 cutout in the system chassis.

Floppy Disk Drive Controller

The G586SPA system board has a built-in floppy disk controller that supports two standard floppy disk drives. You can install any 360KB, 720KB, 1.2MB, 1.44MB, or 2.88MB floppy disk drives.



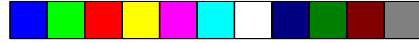

Connecting the Floppy Disk Cable

1. Install the 34-pin header connector into the floppy disk connector (J9) on the system board. The colored edge of the ribbon cable should be aligned with pin 1 of connector J9.
2. Install the other 34-pin header connector(s) into the disk drive(s). Align the colored edge of the daisy chained ribbon cable with pin 1 of the drive edge connector(s). The end-most connector should be attached to the drive you want to designate as Drive A.

IDE Hard Disk Interface

The G586SPA system board is equipped with two PCI IDE shrouded headers that will interface up to four Enhanced IDE (Integrated Drive Electronics) hard disk drives.

Note:

Only IDE hard drives and ATAPI CD-ROMs can be connected to the IDE interface.

Connecting the IDE Hard Disk Interface

To prevent improper IDE cable installation, each PCI IDE shrouded header has a keying mechanism. The 40-pin connector on the IDE cable can be placed into the header only if pin 1 of the connector is aligned with pin 1 of the header.

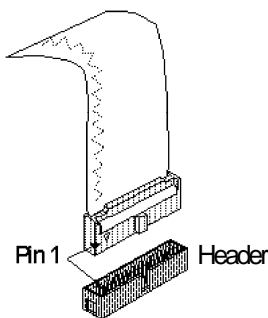

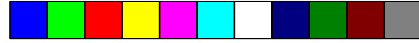

Note:

The IDE cable with a standard 40-pin connector (without the keying mechanism) can be installed in the PCI IDE shrouded header. Be extremely careful to match the colored edge of the ribbon with pin 1 of the header.

Connecting the Hard Disk Cable

1. Connect the cable to the system board. If you are connecting two hard drives, install the 40-pin connector of the IDE cable into the primary IDE shrouded header (connector J11). If you are adding a third or fourth IDE device, install the 40-pin connector of the other IDE cable into the secondary IDE shrouded header (connector J12).
2. Connect the cable to the devices. Install the other 40-pin header connector(s) into the device making sure to match the colored edge of the ribbon cable aligned with pin 1 of the drive edge connector(s).

Note:

Refer to your disk drive user's manual for information about selecting proper drive switch settings.

Adding a Second IDE Hard Drive

When using two IDE drives, one must be set as the master and the other as the slave. Follow the instructions provided by the drive manufacturer for setting the jumpers and/or switches on the drives. No changes are needed on the G586SPA system board when adding a second hard drive.

We recommend that the IDE hard drives be from the same manufacturer. In a few cases, drives from two different manufacturers will not function properly when used together. The problem lies in the hard drives, not the G586SPA system board.



Preparing an IDE Drive for Use

IDE disk drives are already low-level formatted, with any bad-track errors entered, when shipped by the drive manufacturer. Do not attempt to do a low-level format or you may cause serious damage to the drive.

To use an IDE drive, you need to enter the drive type (this information is provided by the drive manufacturer) into the system's CMOS setup table. Then run FDISK and FORMAT provided with DOS.

Warning:

Do not run FDISK and FORMAT programs on a drive that has already been formatted or you will lose all programs and data stored on the drive.

Installing Expansion Cards

The G586SPA system board is equipped with 3 dedicated PCI slots, 3 dedicated 16-bit ISA slots and 1 shared PCI/ISA slot. All PCI slots are bus masters. You can only install one card in one or the other of the shared slots at a time; you cannot install devices in both slots.

Due to the size of the CPU with its accompanying heatsink/fan component, the length of the add-in cards in PCI slots 1 and 2 and ISA slots 1 and 2 is limited to 18cm (measured from the bracket of the card).

Refer to page 12 for the locations of the expansion slots.

Note:

The BIOS needs to be configured for the PCI add-in cards installed in the PCI slots. Refer to the "PCI and Onboard I/O Setup" presented in the "Software Installation" section of the manual.



Chapter 3 Software Installation

After you power up your system, the BIOS message appears on your screen and the memory count begins.

After the memory test, the following message will appear on the screen:

Press DEL to enter setup

If the message disappears before you respond, restart your system or press the “Reset” button on the front of your computer. You may also restart the system by pressing the <Ctrl>, <Alt> and keys simultaneously. If you do not press these keys at the correct time and the system does not boot, the following error message will appear:

Press Del to enter Setup



If you have set a password and selected “System” in the Security Option of the BIOS Features Setup menu, you will be prompted for the password every time the system is rebooted or any time you try to enter Setup. Type in the correct password and press <Enter>.



If you selected “Setup” in the Security Option, you will be prompted for the password only when you try to enter Setup. Refer to the “BIOS Features Setup” section for more information.

Award BIOS CMOS Setup Utility

Press the <Ctrl>, <Alt> and <Esc> keys simultaneously or to enter the Setup utility. A screen similar to the one on the next page will appear.

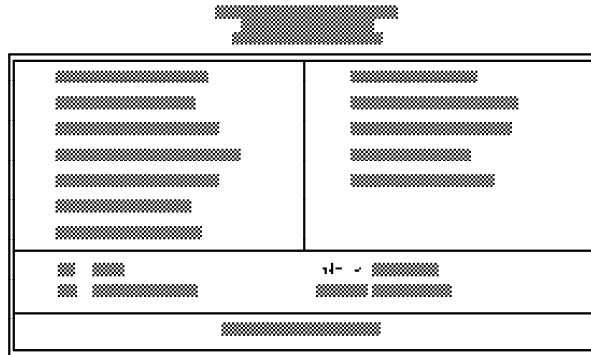

To get the options you want, use the arrow keys to highlight the option and press <Enter>.

Standard CMOS Setup

Use the arrow keys to highlight “Standard CMOS Setup” and press <Enter>. A screen similar to the one below will appear.

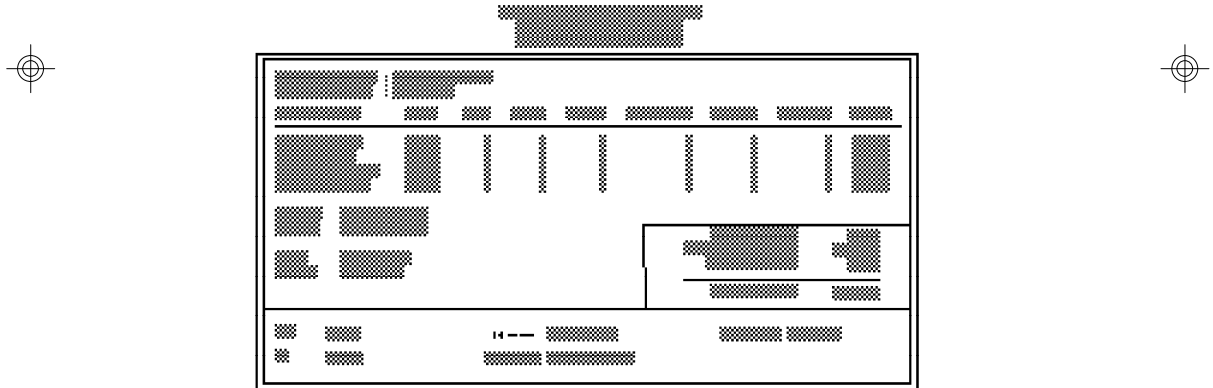

Date and Time

This selection sets the time and date for the system. Press <F3> for the calendar.





Hard Drive Type

This allows you to enter the appropriate specifications for the type of hard disk drive(s) installed in your system. Under the “Type” category, you can select Auto, User, one of 46 predefined drive specifications or None.

Auto: This option indicates that the parameters for your hard disk drive(s) will be automatically detected and displayed when you boot your system. By default, the LBA mode is selected for a hard disk drive larger than 528 megabytes. If you decide not to accept the LBA mode, you can either specify your selection in the “IDE HDD Auto Detection” menu, or use the User option described below.

User: This type is user definable and allows you to enter the specifications yourself. Six categories of information are required: Size, Cylinders, Heads, Precomp, LandZone, Sectors and Mode. This information should be provided by your hard disk vendor or system manufacturer. However, we recommend you use the “IDE HDD Auto Detection” which provides a more efficient way to setup your hard drive.

46 Predefined Drive Specifications: Please refer to your hard disk documentation for the appropriate type number.

None: If a hard drive is not installed, select <None> and press <Enter>.

Drive A and Drive B

These options are used to select the type of floppy disk drives installed in your system. If neither drive is present, select “None”. Make sure you choose the correct drive type; otherwise, your system might format the device improperly.

Video

This is used to select the type of video adapter installed in your system.



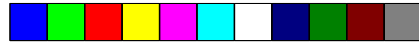

Halt on

This category controls whether the system will halt when an error is detected during power up.

No Errors: The system boot will not stop for any detected errors.

All Errors: The system will stop whenever the BIOS detects a non-fatal error.

All, But Keyboard: The system will stop for any error except a keyboard error.

All, But Diskette: The system will stop for any error except a disk error.

All, But Disk/Key: The system will stop for any error except a keyboard or disk error.

Memory

The lower right hand corner shows the base memory size, extended memory size, and the other memory size of your system. You cannot alter these items; your computer automatically detects and displays them.

The Other Memory size refers to the memory located in the 640K to 1024K address space. This is the memory used for different applications. DOS uses this area to load device drivers to free base memory for application programs.

When you are through making changes in the Standard CMOS Setup, press <Esc> to return to the main menu.

BIOS Features Setup

Use the arrow keys to highlight "BIOS Features Setup" and press <Enter>, a screen similar to the one on the next page will appear.

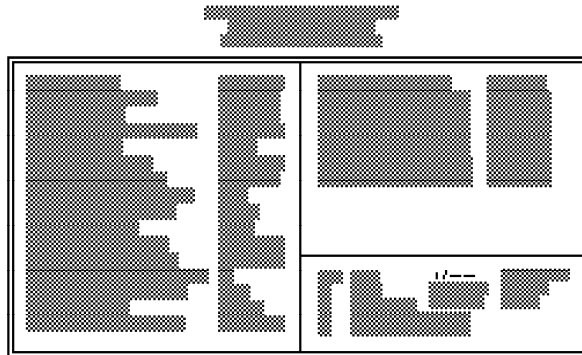
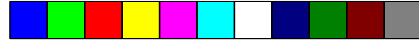

The Virus Warning option may be set to “Enabled” or “Disabled”. If enabled, the BIOS issues a warning when any program or virus sends a Disk Format command or attempts to write to the boot sector of the hard disk drive.

Note:

If you are installing or running certain operating systems such as Windows 95, please disable the Virus Warning or the operating system may not install nor work.

If you choose “System” in the Security Option, you will be prompted for a password every time you cold boot your system or access setup. If you choose “Setup”, you will be prompted for a password only when trying to access setup.

Use the arrow keys to move the highlight bar to the option you wish to change or modify. Use the <Page Up>, <Page Down>, <+> or <-> keys to make the corresponding changes. Press <Esc> after making the changes to return to the main menu.

Chipset Features Setup

The G586SPA uses the SiS chipset. The Chipset Features Setup allows you to modify some functions to optimize system performance. If you press <Enter>, a screen similar to the one on the next page will appear.

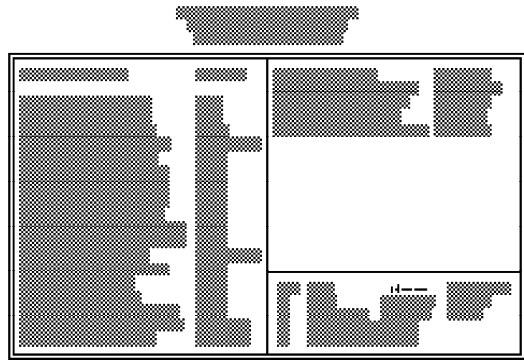

Use the arrow keys to move the highlight bar to the option you wish to change or modify. Use the <Page Up>, <Page Down>, <+> or <-> keys to make the corresponding changes.

If the changes you made are incorrect or you change your mind, press <F6> or <F7> to return to the default settings. Press <Esc> after making the changes to return to the main menu.

Power Management Setup



Use the arrow keys to highlight "Power Management Setup" and press <Enter>. A screen similar to the one below will appear.

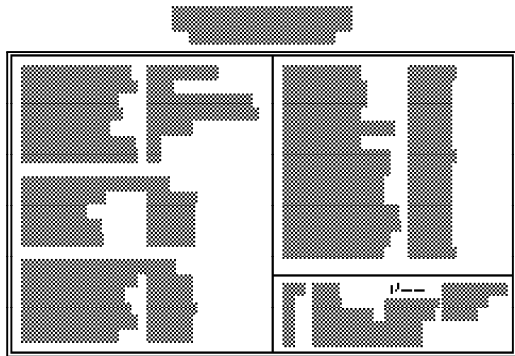

Choosing "Enabled" in the Power Management option will allow you to set Doze Mode, Standby Mode, Suspend Mode and HDD Off After. Choose "Disabled" if you do not want your system to enter the power saving mode.



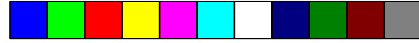

If you are installing Windows 95 on your system and you need to use the Advanced Power Management (APM) function, you must enable the Power Management option so that while installing Windows 95, it will detect that the system board has APM features and load all the corresponding softwares and drivers.

PCI and Onboard I/O Setup

Use the arrow keys to highlight "PCI and Onboard I/O Setup" and press <Enter>; a screen similar to the one below will appear.

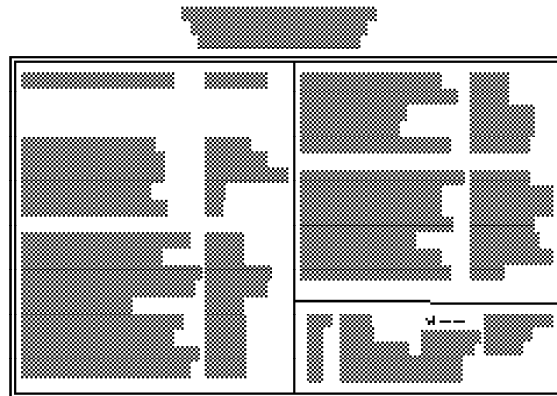

The PCI and Onboard I/O Setup allows you to assign INT A, B, C or D to the hard drives installed in your system. Each INT may then be assigned an IRQ value. This setup also allows you to enable, disable or select the port address of the built-in serial ports, parallel port, floppy disk controller and IR mode.

Load BIOS Defaults

The "Load BIOS Defaults" option loads the troubleshooting default values permanently stored in the ROM chips. These settings are not optimal and turn off all high performance features. You should use these values only if you have hardware problems. Highlight this option on the main menu and press <Enter>. The message below will appear.

Load BIOS Defaults (Y/N)? N



If you want to proceed, press <Y> and the default settings will be loaded.

Load Setup Defaults

The “Load Setup Defaults” option loads optimized settings from the BIOS ROM. Use the Setup default values as standard values for your system.

Highlight this option on the main menu and press <Enter>. The message below will appear.

Load Setup Defaults (Y/N)? N

Type <Y> and press <Enter> to load the Setup default values.

Password Setting

If you want to set a password, make sure that the Security Option under the BIOS Features Setup is set to “System” or “Setup”. Refer to the BIOS Features Setup for more information.

Use the arrow keys to highlight the Password Setting option and press <Enter>. The message below will appear.

Enter Password:

Type in the password. You are limited to eight characters. When done, the message below will appear:

Confirm Password:

You are asked to verify the password. Type in exactly the same password. If you type in a wrong password, you will be prompted to enter the correct password again.

To delete or disable the password function, simply press <Enter> instead of typing in a password. Press the <Esc> key to return to the main menu.





IDE HDD Auto Detection

This option detects the hard disk parameters for the hard disk drives installed in your system. Highlight this option and press <Enter>. A screen similar to the one below will appear.



Enter your choice, and press <Enter> to accept the parameters or press <Esc> to abort. The parameters of the hard disk will be displayed in the Standard CMOS Setup.

Hard Drive Mode

The G586SPA supports three HDD modes: Normal, LBA and Large. If your hard disk drive does not support LBA mode, the "LBA" option will not be displayed. If your HDD has 1024 or fewer cylinders, the "Large" option will not be displayed.

Normal Mode

The Normal mode is the generic access mode in which neither the BIOS nor the IDE controller will make any transformations during hard-drive access.

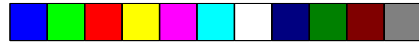

The maximum number of cylinders, heads and sectors for Normal mode are 1024, 16 and 63 respectively.

	no. Cylinders	(1024)
x	no. Heads	(16)
x	no. Sectors	(63)
x	bytes per sector	(512)

528 megabytes

If you set your HDD to Normal mode, the maximum accessible HDD will be 528 megabytes even though the physical size of the HDD may be larger.

LBA (Logical Block Addressing) Mode

The LBA mode is a HDD accessing method to overcome the 528 megabyte limitation. The number of cylinders, heads and sectors shown on the screen may not be the actual number for the HDD.

During the HDD accessing, the IDE controller will transform the logical address described by the sector, head and cylinder number into its own physical address inside the HDD.

The maximum HDD size supported by the LBA mode is 8.4 gigabytes. It is obtained by the following formula.

	no. Cylinders	(1024)
x	no. Heads	(225)
x	no. Sectors	(63)
x	bytes per sector	(512)

8.4 gigabytes

Large Mode

The Large mode is the extended HDD access mode supported by the G586SPA system board. Some IDE HDDs have more than 1024 cylinders without LBA support (in some cases, you may not want the LBA mode). This system board provides another alternative to support these kinds of HDDs.

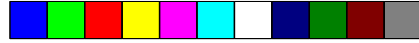

The BIOS tells the operating system that the number of cylinders is half of the actual number and that the number of heads is double the actual number. During disk access, the reverse conversion is done by the INT13h routine.

Maximum HDD size:

no. Cylinders	(1024)
x no. Heads	(32)
x no. Sectors	(63)
x bytes per sector	(512)
1 gigabyte		

Note:

To support LBA or Large mode, address translation software is included in the Award BIOS HDD Service Routine (INT13h). If you are running an operating system that bypasses the BIOS Int13 Service Routine, LBA and Large Mode may fail.

HDD Low Level Format

This option will format, set the interleave mode and do a media analysis of your hard drives. Highlight this option and press <Enter>. A screen similar to the one below will appear.

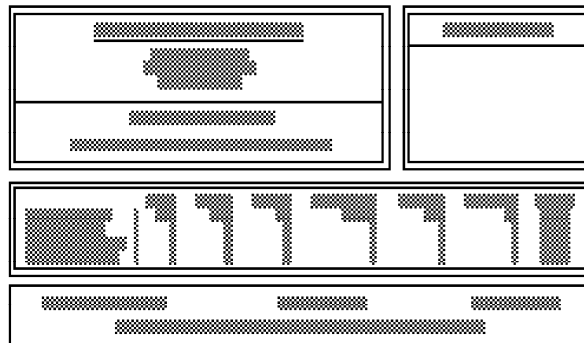

Warning:

Do not attempt to do a low-level format, or you may cause serious damage to the drive. IDE disk drives are already low-level formatted, with any bad-track errors entered, when shipped by the drive manufacturer.



Use the arrow keys to select an option and press <Enter> to accept the option. Press <Esc> when done.

Save & Exit Setup

When all the changes have been made, highlight “Save & Exit Setup” and press <Enter>. The message below will appear:

Save to CMOS and Exit (Y/N)? N

Type “Y” and press <Enter>. The following message will appear:

Reboot System (Y/N)? N

Type “Y” and press <Enter>. The modifications you have made will be written into the CMOS memory, and the system will reboot. You will once again see the initial diagnostics on the screen. If you wish to make additional changes to the setup, press the <Ctrl>, <Alt> and <Esc> keys simultaneously or after memory testing is done.

Exit Without Saving

When you do not want to save the changes you have made, highlight “Exit Without Saving” and press <Enter>. The message below will appear:

Quit Without Saving (Y/N)? N

Type “Y” and press <Enter>. The system will reboot and you will once again see the initial diagnostics on the screen. If you wish to make any changes to the setup, press the <Ctrl>, <Alt> and <Esc> keys simultaneously or after memory testing is done.





System Error Report

When the BIOS encounters an error that requires the user to correct something, either a beep code will sound or a message will be displayed in a box in the middle of the screen and the message **PRESS F1 TO CONTINUE, CTRL-ALT-ESC or DEL TO ENTER SETUP**, will be shown in the information box at the bottom. Enter Setup to correct the error.

POST Beep

There is one beep code in the BIOS. This code indicates that a video error has occurred and the BIOS cannot initialize the video screen to display any additional information. This beep code consists of a single long beep followed by two short beeps. If you get this error, contact your system board dealer or representative.

Error Messages

One or more of the following messages may be displayed if the BIOS detects an error during the POST.

DISK BOOT FAILURE, INSERT SYSTEM DISK AND PRESS ENTER

No boot device was found. Insert a system disk into Drive A and press <Enter>. If the system normally boots from the hard drive, make sure the controller is inserted correctly and all cables are properly attached. Also be sure the disk is formatted as a boot device. Reboot the system.

DISKETTE DRIVES OR TYPES MISMATCH ERROR - RUN SETUP

The type of diskette drive installed in the system is different from the CMOS definition. Run setup to reconfigure the drive type correctly.

DISPLAY SWITCH IS SET INCORRECTLY

The display switch on the system board can be set to either monochrome or color. This error indicates the switch is set to a different setting than indicated in Setup. Determine which setting is correct and either turn off the system and change the jumper or enter Setup and change the VIDEO selection.

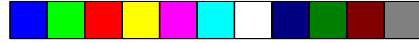

DISPLAY TYPE HAS CHANGED SINCE LAST BOOT

Since last powering off the system, the display adapter has been changed. You must configure the system for the new display type.

ERROR ENCOUNTERED INITIALIZING HARD DRIVE

The hard drive cannot be initialized. Be sure all cables are correctly and firmly attached. Also, be sure the correct hard drive type is selected in Setup.

ERROR INITIALIZING HARD DISK CONTROLLER

The system cannot initialize the controller. Be sure the correct hard drive type is selected in Setup. Also, check to see if any jumper needs to be set correctly on the hard drive.

FLOPPY DISK CNTRLR ERROR OR NO CNTRLR PRESENT

The system cannot find or initialize the floppy drive controller. If no floppy drive is installed, be sure the Diskette Drive selection in Setup is set to NONE.

KEYBOARD ERROR OR NO KEYBOARD PRESENT

Cannot initialize the keyboard. Make sure the keyboard is attached correctly and no keys are being pressed during the boot.

If you are purposely configuring the system without a keyboard, set the error halt condition in Setup to HALT ON ALL, BUT KEYBOARD. This will cause the BIOS to ignore the missing keyboard and continue the boot.

MEMORY ADDRESS ERROR AT..

Indicates a memory address error at a specific location. You can use this location along with the memory map for your system to find and replace the bad memory chips.

MEMORY SIZE HAS CHANGED SINCE LAST BOOT

Memory has been added or removed since the last boot. Enter Setup and enter the new memory size in the memory fields.

MEMORY VERIFY ERROR AT..

Indicates an error verifying a value already written to memory. Use the location along with your system's memory map to locate the bad chip.

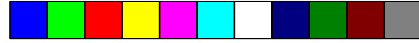

OFFENDING ADDRESS NOT FOUND

This message is used in conjunction with the I/O CHANNEL CHECK and RAM PARITY ERROR messages when the segment that has caused the problem cannot be isolated.

OFFENDING SEGMENT

This message is used in conjunction with the I/O CHANNEL CHECK and RAM PARITY ERROR messages when the segment that has caused the problem has been isolated.

PRESS A KEY TO REBOOT

This will be displayed at the bottom screen when an error occurs that requires a reboot. Press any key and the system will reboot.

PRESS F1 TO DISABLE NMI, F2 TO REBOOT

When BIOS detects a Non-Maskable Interrupt condition during boot, this will allow NMI to be disabled and continue to boot. You can also reboot the system with the NMI enabled.

SYSTEM HALTED, (CTRL-ALT-DEL) TO REBOOT...

Indicates the present boot attempt has been aborted and the system must be rebooted. Press and hold down the <CTRL>, <ALT> and keys simultaneously.

IDE Device Drivers

To install the IDE device drivers supported by the G586SPA system board, please refer to the "Readme" file contained in the provided diskette.

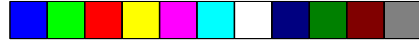

Chapter 4 Troubleshooting Checklist

If you experience difficulty with the G586SPA system board, please refer to the checklist below. If you still cannot identify the problem, please contact your dealer.

1. Check the jumper settings to ensure that the jumpers are properly set. If in doubt, refer to the “Hardware Installation” section.
2. Verify that all SIMMs are seated securely into the bank sockets.
3. Make sure the SIMMs are in the correct locations.
4. Check that all populated memory banks are filled with correctly sized SIMMs.
5. If your board fails to function, place the board on a flat surface and seat all socketed components (gently press each component into the socket).
6. If you made changes to the BIOS settings, re-enter setup and load the BIOS defaults.

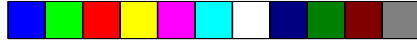

Appendix A Types of Modules

The G586SPA system board allows you to populate memory with 1MBx32/x36, 2MBx32/x36, 4MBx32/x36, 8MBx32/x36, and 16MBx32/x36 SIMMs. The following modules have been tested with this board. Most untested brands will work but a few may fail to do so.

SIMM	Brand	Chip Number
1MBx32/x36	Fujitsu	81C1000A-70
	Hyundai	HY514400A
	Toshiba	TC511000AJL
	OKI	M51440A-70
2MBx32/x36	OKI	M511000B-70
	NEC	424400-60
	Micron	40447-60
	TI	TMS4400DJ-70
	Micron	MT4C4007-70 (EDO)
	Micron	MT4C4007-60 (EDO)
4MBx32/x36	NEC	4218165-60 (EDO)
	Hitachi	7400AS-70
	Fujitsu	8117400-70
	Mitsubishi	422A06-70
	Hitachi	5117400AS-70
	NEC	4217400-60
NEC	4217405-70 (EDO)	



Appendix B Memory and I/O Maps

Memory Address Map

Address	Name	Function
0000000 to 009FFFF	640KB System Board RAM	System Board Memory
00A0000 to 00BFFFF	128KB Video Display Memory	Reserved for Graphics Display Memory
00C0000 to 00E7FFF	160KB I/O Expansion ROM	Reserved for ROM on I/O Adapter Card
00E8000 to 00FFFFFF	96KB ROM on the System Board	System Board BIOS
0100000 to FFFFFFFF	Maximum Memory 256MB	System Board Memory

IO Address Map

IO Address	Function
000-01F	DMA Controller 1, 8237A-5
020-03F	Interrupt Controller 1, 8259A, Master
040-05F	Timer, 8254-2
060-06F	8742 (Keyboard Controller)
070-07F	Real-time Clock, NMI (Non-maskable Interrupt) Mask
080-09F	DMA Page Memory, 74LS612
0A0-0BF	Interrupt Controller 2, 8259A
0C0-0DF	DMA Controller 2, 8237A-5
0E8	Shadow RAM and Cache Control Bit
0F0	Clear Numeric Processor Extension Busy
0F1	Reset Numeric Processor Extension
0F8-0FF	Numeric Processor Extension
1F0-1F8	Fixed Disk
200-207	Game I/O
278-27F	Parallel Printer Port 2
2F8-2FF	Serial Port 2
300-31F	Prototype Card
360-36F	Reserved
378-37F	Parallel Printer Port 1
380-38F	SDLC, Bisynchronous 2
3A0-3AF	Bisynchronous 1
3B0-3BF	Monochrome Display and Printer Adapter
3C0-3CF	Reserved
3D0-3DF	Color/Graphics Monitor Adapter
3F0-3F7	Diskette Controller
3F8-3FF	Serial Port 1

Note:

*The I/O address hex 000 to 0FF are reserved for the system board I/O.
Hex 100 to 3FF are available on the I/O channels.*

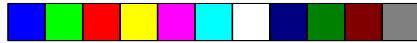

Appendix C PCI I/O Pin Assignments

Component Side	B	A	Solder Side
	-12V	- 01 -	TRST#
	TCK	- 02 -	+12V
	Ground	- 03 -	TMS
	TDO	- 04 -	TDI
	+5V	- 05 -	+5V
	+5V	- 06 -	INTA#
	INTB#	- 07 -	INTC#
	INTD#	- 08 -	+5V
	PRSNT1#	- 09 -	Reserved
	Reserved	- 10 -	+5V (I/O)
	PRSNT2#	- 11 -	Reserved
	Ground	- 12 -	Ground
	Ground	- 13 -	Ground
	Reserved	- 14 -	Reserved
	Ground	- 15 -	RST#
	CLK	- 16 -	+5V (I/O)
	Ground	- 17 -	GNT#
	REQ#	- 18 -	Ground
	+5V (I/O)	- 19 -	Reserved
	AD[31]	- 20 -	AD[30]
	AD[29]	- 21 -	N. C.
	Ground	- 22 -	AD[28]
	AD[27]	- 23 -	AD[26]
	AD[25]	- 24 -	Ground
	N. C.	- 25 -	AD[24]
	C/BE[3]#	- 26 -	IDSEL
	AD[23]	- 27 -	N. C.
	Ground	- 28 -	AD[22]
	AD[21]	- 29 -	AD[20]
	AD[19]	- 30 -	Ground
	N. C.	- 31 -	AD[18]
	AD[17]	- 32 -	AD[16]
	C/BE[2]#	- 33 -	N. C.
	Ground	- 34 -	FRAME#
	IRDY#	- 35 -	Ground
	N. C.	- 36 -	TRDY#
	DEVSEL#	- 37 -	Ground
	Ground	- 38 -	STOP#
	LOCK#	- 39 -	N. C.
	PERR#	- 40 -	SDONE
	N. C.	- 41 -	SBO#
	SERR#	- 42 -	Ground
	N. C.	- 43 -	PAR
	C/BE[1]#	- 44 -	AD[15]
	AD[14]	- 45 -	N. C.
	Ground	- 46 -	AD[13]
	AD[12]	- 47 -	AD[11]
	AD[10]	- 48 -	Ground
	Ground	- 49 -	AD[09]
	AD[08]	- 52 -	C/BE[0]#
	AD[07]	- 53 -	N. C.
	N. C.	- 54 -	AD[06]
	AD[05]	- 55 -	AD[04]
	AD[03]	- 56 -	Ground
	Ground	- 57 -	AD[02]
	AD[01]	- 58 -	AD[00]
	+5V (I/O)	- 59 -	+5V (I/O)
	ACK64#	- 60 -	REQ64#
	+5V	- 61 -	+5V
	+5V	- 62 -	+5V

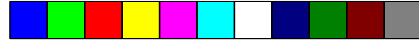

Appendix D ISA I/O Pin Assignments

B		A
Grnd	- 01 -	-I/OChck
ResetDrv	- 02 -	SD7
+5VDC	- 03 -	SD6
IRQ9	- 04 -	SD5
-5VDC	- 05 -	SD4
DRQ2	- 06 -	SD3
-12VDC	- 07 -	SD2
O/S	- 08 -	SD1
+12VDC	- 09 -	SD0
Grnd	- 10 -	-I/OChrdy
-SEMEMV	- 11 -	AEN
-SEMEMR	- 12 -	SA19
-IOW	- 13 -	SA18
-IOR	- 14 -	SA17
-Dack3	- 15 -	SA16
-DRQ3	- 16 -	SA15
-Dack1	- 17 -	SA14
DRQ1	- 18 -	SA13
-Refresh	- 19 -	SA12
CLK	- 20 -	SA11
IRQ7	- 21 -	SA10
IRQ6	- 22 -	SA9
IRQ5	- 23 -	SA8
IRQ4	- 24 -	SA7
IRQ3	- 25 -	SA6
-Dack2	- 26 -	SA5
TC	- 27 -	SA4
Bale	- 28 -	SA3
+5VDC	- 29 -	SA2
OSC	- 30 -	SA1
Grnd	- 31 -	SA0

D		C
-MemCS16	- 01 -	SBHE
-I/OCS16	- 02 -	LA23
IRQ10	- 03 -	LA22
IRQ11	- 04 -	LA21
IRQ12	- 05 -	LA20
IRQ13	- 06 -	LA19
IRQ14	- 07 -	LA18
-Dack0	- 08 -	LA17
DRQ0	- 09 -	-Memr
-Dack5	- 10 -	-Memw
DRQ5	- 11 -	SD08
-Dack6	- 12 -	SD09
DRQ6	- 13 -	SD10
-Dack7	- 14 -	SD11
DRQ7	- 15 -	SD12
+5VDC	- 16 -	SD13
-Master	- 17 -	SD14
Grnd	- 18 -	SD15

Appendix E System Overview

DMA Controller 1	DMA Controller 2
Ch0-Reserved for User	Ch4-Cascade for CTRL 1
Ch1-Reserved for User	Ch5-Reserved for User
Ch2-Diskette	Ch6-Reserved for User
Ch3-Reserved for User	Ch7-Reserved for User

Note:

DMA controller 1 supports 8-bit data transfer.

DMA controller 2 supports 16-bit data transfer.

Address Generation for DMA Channels 3 to 0

Source Address	DMA Page Memory	DMA Controller 1
	A23 ↔ A16	A15 ↔ A0

Address Generation for DMA Channels 7 to 5

Source Address	DMA Page Memory	DMA Controller 2
	A23 ↔ A17	A16 ↔ A1

Page Memory Address

IO Port Address	Page Memory
0081H	DMA Channel 2
0082H	DMA Channel 3
0083H	DMA Channel 1
0087H	DMA Channel 0
0089H	DMA Channel 6
008AH	DMA Channel 7
008BH	DMA Channel 5

System Interrupts

Interrupt Controller 1	Interrupt Controller 2
IRQ0-Timer Output (Out 0)	IRQ8-Realtime Clock INT
IRQ1-KeyBoard (Output Buffer Full)	IRQ9-Software Redirected to INT 0AH (IRQ2)
IRQ2-Interrupt from INTR2	IRQ10-Reserved
IRQ3-Serial Port 2	IRQ11-Reserved
IRQ4-Serial Port 1	IRQ12-PS/2 Mouse
IRQ5-Parallel Port 2 or 3 *	IRQ13-Coprocessor
IRQ6-Diskette Controller	IRQ14-Primary Fixed Disk Controller (1F0)
IRQ7-Parallel Port 1 or 2 *	IRQ15-Secondary Fixed Disk Controller (170)

* The one on-board parallel port can be configured to either Parallel Port 1, 2 or 3. Parallel Port 1 uses I/O address 3BCh, Parallel Port 2 uses I/O address 378h, and Parallel Port 3 uses I/O address 278H.

Note:

The 16 levels of system interrupts have the following priority:
 IRQ0> IRQ1> IRQ8> IRQ9> IRQ10> IRQ11> IRQ12> IRQ13>
 IRQ14> IRQ15> IRQ3> IRQ4> IRQ5> IRQ6> IRQ7.

System Timers

Channel 0	Channel 1	Channel 2
System Timer (IRQ0)	Refresh Request Generator (15µs Rate Generator Period Signal)	Tone Generation for Speaker

Real-Time Clock

Address	Function	Address	Function
00	Seconds	07	Date of Month
01	Second Alarm	08	Month
02	Minutes	09	Year
03	Minute Alarm	0A	Register A
04	Hours	0B	Register B
05	Hour Alarm	0C	Register C
06	Day of Week	0D	Register D



Appendix F Connector Pin Assignments

Connector J2 PS/2 Keyboard Connector

Pin	Function
1	Keyboard Data
2	Reserved
3	Ground
4	+5V
5	Keyboard Clock
6	Reserved

Connector J2 AT Keyboard Connector

Pin	Function
1	Keyboard Clock
2	Keyboard Data
3	Reserved
4	Ground
5	+5V

Connector J3 PS/2 Mouse Connector

Pin	Function
1	Mouse Data
2	Reserved
3	Ground
4	+5V
5	Mouse Clock
6	Reserved

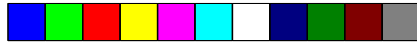

Connector J6
Power Connector

Pin	Function	Pin	Function
1	Power Good	7	Ground
2	+5V	8	Ground
3	+12V	9	-5V
4	-12V	10	+5V
5	Ground	11	+5V
6	Ground	12	+5V

Connectors J7 and J8
COM A and COM B Serial Ports

Pin	Function
1	DCD (Data Carrier Detect)
2	RX (Receive Data)
3	TX (Transmit Data)
4	DTR (Data Terminal Ready)
5	Ground (Signal Ground)
6	DSR (Data Set Ready)
7	RTS (Request to Send)
8	CTS (Clear to Send)
9	RI (Ring Indicator)

Connector J9
Floppy Disk Drive Connector

Pin	Function	Pin	Function
1	Ground	11	Ground
2	DENSEL	12	DR1
3	Ground	13	Ground
4	Reserved	14	DR0
5	Ground	15	Ground
6	Drate0	16	MTR1
7	Ground	17	Drate1
8	Index	18	Dir
9	Ground	19	Ground
10	MTR0	20	Step



Pin	Function	Pin	Function
21	Ground	28	Wr Protect
22	Write Data	29	Ground
23	Ground	30	Read Data
24	Write Gate	31	Ground
25	Ground	32	Head Select
26	Track 0	33	Ground
27	MSEN	34	Disk Change

Connector J10
Parallel Printer Port

Pin	SPP	EPP	ECP
1	-STB	-Write	-STB
2	PD <0:7>	PD <0:7>	PD <0:7>
3	PD <0:7>	PD <0:7>	PD <0:7>
4	PD <0:7>	PD <0:7>	PD <0:7>
5	PD <0:7>	PD <0:7>	PD <0:7>
6	PD <0:7>	PD <0:7>	PD <0:7>
7	PD <0:7>	PD <0:7>	PD <0:7>
8	PD <0:7>	PD <0:7>	PD <0:7>
9	PD <0:7>	PD <0:7>	PD <0:7>
10	-ACK	Intr	-ACK
11	BUSY	-Wait	BUSY, PeriphAck(2)
12	FE	FE	PEerror, -AckReverse(2)
13	SLCT	Select	SLCT
14	-AFD	-DStrb	-AFD, HostAck(2)
15	-ERR	-Error	-Fault(1), -PeriphRequest(2)
16	-INIT	-Init	-INIT(1), -ReverseRqst(2)
17	-SLIN	-AStrb	-SLIN(1,2)
18	Ground	Ground	Ground
19	Ground	Ground	Ground
20	Ground	Ground	Ground
21	Ground	Ground	Ground
22	Ground	Ground	Ground
23	Ground	Ground	Ground
24	Ground	Ground	Ground
25	Ground	Ground	Ground

- (1) - Compatible mode
- (2) - High speed mode

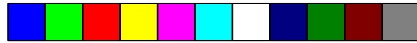

Connectors J11 and J12

Primary and Secondary IDE Hard Disk Drive Connectors

Pin	Function	Pin	Function
1	-Reset	21	Reserved
2	Ground	22	Ground
3	D7	23	-IOW
4	D8	24	Ground
5	D6	25	-IOR
6	D9	26	Ground
7	D5	27	Reserved
8	D10	28	BALE
9	D4	29	Reserved
10	D11	30	Ground
11	D3	31	IRQ
12	D12	32	IOCS16
13	D2	33	SA1
14	D13	34	Reserved
15	D1	35	SA0
16	D14	36	SA2
17	D0	37	HCS0
18	D15	38	HCS1
19	Ground	39	LED
20	Reserved	40	Ground

Connector J13

12V Fan Connector

Pin	Function
1	+12V
2	Ground

Connector J14

External Battery Connector

Pin	Function
1	3.6V Lithium Battery
2	Key
3	Ground
4	Ground



Connector J15
IrDA Connector

Pin	Function
1	IRTX
2	GND
3	IRRX
4	NC
5	VCC

The IrDA port option in the PCI & Onboard I/O Setup of the BIOS utility must be set to "Enabled". This port occupies serial port 2.

Connector J16
IDE LED Connector

Pin	Function
1	LED Power
2	Signal



Connector J17
Suspend Switch



Pin	Function
1	Signal
2	Ground

Connector J18
Green LED Connector

Pin	Function
1	Signal
2	LED Power

Connector J19
Turbo LED Connector

Pin	Function
1	Signal
2	LED Power

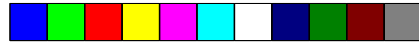

Connector J20
Turbo Switch

Pin	Function
1	Ground
2	Signal

Connector J21
Reset Switch

Pin	Function
1	Ground
2	Reset

Connector J22
Speaker Connector

Pin	Function
1	Signal
2	Reserved
3	Ground
4	+5V

Connector J23
Power LED/Keylock Connector

Pin	Function
1	LED Signal
2	Reserved
3	Ground
4	Keylock Signal
5	Ground



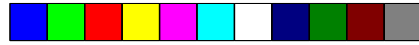

For reference only. Not included in the manual.

Intel CPU	Cyrix CPU	CPU External Speed	JP3	JP4	Frequency Ratio	JP12	JP13
75MHz	None	50MHz	On	On	1.5x	Off	Off
90MHz	None	60MHz	Off	On	1.5x	Off	Off
None	P120+	50MHz	On	On	2x	On	Off
None	P133+	55MHz	Off	Off	2x	On	Off
100MHz*	None	66MHz	On	Off	1.5x	Off	Off
120MHz	P150+	60MHz	Off	On	2x	On	Off
133MHz	P166+	66MHz	On	Off	2x	On	Off
150MHz	None	60MHz	Off	On	2.5x	On	On
166MHz	None	66MHz	On	Off	2.5x	On	On
180MHz	None	60MHz	Off	On	3x	Off	On
200MHz	None	66MHz	On	Off	3x	Off	On

* Default