



# **G586VPMR**

**Rev. 0 +  
System Board  
User's Manual**



**- D30660228 -**



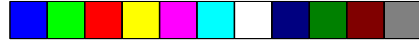

## FCC Statement on Class B

This equipment has been tested and found to comply with the limits for a Class B digital device, pursuant to Part 15 of the FCC rules. These limits are designed to provide reasonable protection against harmful interference when the equipment is operated in a residential installation. This equipment generates, uses and can radiate radio frequency energy and, if not installed and used in accordance with the instruction manual, may cause harmful interference to radio communications. However, there is no guarantee that interference will not occur in a particular installation. If this equipment does cause harmful interference to radio or television reception, which can be determined by turning the equipment off and on, the user is encouraged to try to correct the interference by one or more of the following measures:

- Reorient or relocate the receiving antenna.
- Increase the separation between the equipment and the receiver.
- Connect the equipment into an outlet on a circuit different from that to which the receiver is connected.
- Consult the dealer or an experienced radio TV technician for help.

### Notice:

1. The changes or modifications not expressly approved by the party responsible for compliance could void the user's authority to operate the equipment.
2. Shielded interface cables must be used in order to comply with the emission limits.

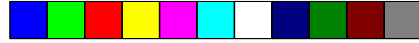

## Contents

<b>Chapter 1: Introduction .....</b>	<b>5</b>
Features and Specifications .....	6
Package Checklist .....	8
<b>Chapter 2: Hardware Installation .....</b>	<b>9</b>
Preparing the Area .....	9
Handling the System Board .....	9
Static Electricity Precautions .....	10
Installing the System Board .....	10
Board Layout .....	12
System Memory .....	12
Installing a SIM Module .....	13
Memory Configuration .....	13
Cache Memory .....	14
Installing the Cache Module .....	15
CPU Installation .....	16
Jumper Settings for CPU .....	16
Installing Upgrade CPUs .....	18
Jumper Settings for PCI Slot 4 .....	22
Jumper Settings for Parallel Port .....	22
Jumper Settings for Display .....	23
Jumper Settings for PS/2 Mouse .....	23
Factory Testing Jumpers .....	24
Built-in Ports .....	24
Serial Ports .....	24
PS/2 Mouse Port .....	25
Parallel Port .....	25
Floppy Disk Drive Controller .....	25
IDE Hard Disk Interface .....	26
Installing Expansion Cards .....	27
<b>Chapter 3: Initial Setup Program .....</b>	<b>28</b>
Award BIOS CMOS Setup Utility .....	28
Standard CMOS Setup .....	29
BIOS Features Setup .....	31
Chipset Features Setup .....	32
Power Management Setup .....	33

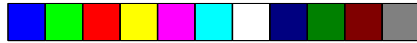

PCI Configuration Setup .....	33
Load BIOS Defaults .....	34
Load Setup Defaults .....	34
Password Setting .....	35
IDE HDD Auto Detection .....	36
HDD Low Level Format .....	36
Save & Exit Setup .....	37
Exit Without Saving .....	37
IDE Device Drivers .....	38
<b>Chapter 4: Troubleshooting Checklist .....</b>	<b>39</b>
<b>Appendix A: Types of Modules .....</b>	<b>40</b>
<b>Appendix B: System Error Report .....</b>	<b>42</b>
<b>Appendix C: Memory and I/O Maps .....</b>	<b>46</b>
<b>Appendix D: PCI I/O Pin Assignments .....</b>	<b>48</b>
<b>Appendix E: ISA I/O Pin Assignments .....</b>	<b>49</b>
<b>Appendix F: Connector Pin Assignments .....</b>	<b>50</b>
<b>Appendix G: Award BIOS Hard Disk Table .....</b>	<b>55</b>
<b>Appendix H: System Overview .....</b>	<b>58</b>

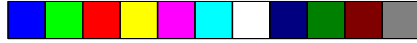

## Chapter 1 Introduction

---

### Introduction

The G586VPMR system board offers several advanced features integrated into the system board. It supports a 320-pin Zero Insertion Force (ZIF) CPU socket for Cyrix P120+, P133+, P150+ or P166+ CPUs. These Cyrix CPUs support Linear burst mode, with power supply supporting up to 10 ampere CPU power consumption. The ZIF socket allow users to easily upgrade their CPUs. The G586VPMR also supports Flash EPROM for easy BIOS upgrades. Flash EPROM is a memory chip for the storage of BIOS which can be erased in bulk or modified using a software utility.

Equipped with two built-in Bus Master PCI IDE connectors, the G586VPMR system board can control four drives and supports fast PIO Modes 3 and 4 hard drives and hard drives larger than 528MB. Bus mastering reduces CPU use during disk transfer. The system board is also equipped with two NS16C550A-compatible serial ports, an SPP/EPP/ECP, a floppy disk drive controller, and one mini-DIN-6 connector for the PS/2 mouse.

The G586VPMR can be configured to 22 different memory sizes ranging from 4MB to 512MB using 256KBx32/36, 512KBx32/36, 1MBx32/36, 2MBx32/36, 4MBx32/36, 8MBx32/36 or 16MBx32/36 non-parity/parity SIM modules.



## Features and Specifications

### Processor

- Cyrix P120+, P133+, P150+ or P166+
  - Linear burst mode supported
  - Power supply: supports up to 10 ampere CPU power consumption

### Chipset

- VLSI Wildcat chipset
  - VLSI VL82C594 - system controller
  - VLSI VL82C595 - data buffer
  - VLSI VL82C597 - PCI bridge

### Cache Memory

- One 160-pin cache module slot
- Supports 256KB or 512KB buffered write-through cache module
- Uses 3.3V pipeline burst SRAM

### System Memory

- Up to 512MB
- Eight 72-pin single and/or double density SIMM sockets
- 256KBx32/36, 512KBx32/36, 1MBx32/36, 2MBx32/36, 4MBx32/36, 8MBx32/36 or 16MBx32/36 non-parity/parity SIMMs
- 60ns or 70ns fast page mode DRAM or EDO DRAM

### BIOS

- Award Flash BIOS, Windows 95 Plug and Play compatible
- Supports IDE HDDs larger than 528MB (LBA mode only)

### Energy Efficient Design

- System Power Management supported
- Microsoft/Intel APM V1.1 compliant
- Highly efficient switching power circuit
- CPU stopped clock control

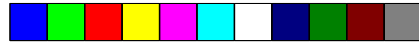

### **PCI IDE Connectors**

- CMD 646 Bus Master PCI IDE chip
- Two IDE connectors to control four drives
- PIO Modes 3 & 4 Enhanced IDE
- DMA Mode 2 Bus Master IDE
- ATAPI IDE CD-ROM supported

### **Integrated I/O**

- Two NS16C550A-compatible high speed UARTs
- One SPP/EPP/ECP
- Supports 720KB, 1.2MB, 1.44MB and 2.88MB floppy drives

### **ZIF Socket**

- One 320-pin ZIF socket (Intel Socket 5)

### **Connectors**

- 2 serial ports
- 1 parallel port
- 2 IDE connectors
- 1 floppy connector
- 1 PS/2 mouse port
- 1 mini-DIN-6 PS/2 keyboard connector or AT keyboard connector

### **Expansion Slots**

- 3 dedicated PCI slots
- 3 dedicated 16-bit ISA slots
- 1 shared PCI/ISA slot

### **PCB**

- 6 layers, Baby AT form factor
- 33cm (12.87") x 22cm (8.58")

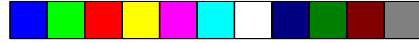

## Package Checklist

The G586VPM/R package contains the following items:

- G586VPM/R system board
- G586VPM/R user's manual
- One 40-pin IDE hard disk cable
- One 34-pin floppy disk drive cable
- One 25-pin printer port cable for chassis mounting
- One card-edge bracket with serial and mouse port cables
- One IDE driver diskette

If any of these items are missing or damaged, please contact your dealer or sales representative for assistance.



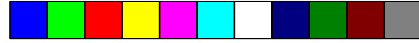

## Chapter 2 Hardware Installation

---

This chapter summarizes the steps in installing the G586VPM/R system board into your system unit. It also includes a description of the area in which you must work and directions for memory installation. Before installing the system board, obtain the memory you plan to install. Please refer to the memory chart on pages 13 and 14 for the number and type of SIM modules needed for the amount of memory you require.

### Preparing the Area

Before unpacking the system board, make sure the location you have selected is relatively free of dust and static electricity. Excessive exposure to dust, static electricity, direct sunlight, excessive humidity, extreme cold, and water can damage the operational capabilities of your system board. Avoid placing the unit on surfaces such as carpeted floors. These areas also attract static electricity which can damage some circuits on your system board.

Make sure the power source has a properly grounded, three-pronged socket. It is essential that the power connection be properly grounded for correct functioning of your system board. For further protection, we recommend that you use a surge suppressor. This will protect the system board from damage that may result from a power surge on the electrical line.

Move items that generate magnetic fields away from your system board since magnetic fields can also damage your system board. Once you have selected the ideal location, unpack the G586VPM/R system board carefully.

### Handling the System Board

It is quite easy to inadvertently damage your system board even before installing it in your system unit. Static electrical discharge can damage computer components without causing any signs of physical damage. You must take extra care in handling the system board to ensure against electrostatic build-up.

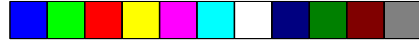

## Static Electricity Precautions

1. To prevent electrostatic build-up, leave the board in its anti-static bag until you are ready to install it.
2. Wear an antistatic wrist strap.
3. Do all preparation work on a static-free surface with components facing up.
4. Hold the system board by its edges only. Be careful not to touch any of the components, contacts or connections, especially gold contacts, on the board.
5. Avoid touching the pins or contacts on all modules and connectors. Hold modules and connectors by their ends.

### **Warning:**

*Electrostatic discharge (ESD) can damage your processor, disk drives, add-in boards, and other components. Perform the upgrade instruction procedures described at an ESD workstation only. If such a station is not available, you can provide some ESD protection by wearing an anti-static wrist strap and attaching it to a metal part of the system chassis. If a wrist strap is unavailable, establish and maintain contact with the system chassis throughout any procedures requiring ESD protection.*

## Installing the System Board

If you are installing the G586VPMR system board, the following outlines the basic installation instructions. Before installing the system board into your system unit, you should prepare the tools you will need:

You will need:

- *One medium size, flat-bladed screwdriver*
- *One medium Phillips screwdriver*

1. Unlock your system unit. Turn off the power and disconnect all power cords and cables.

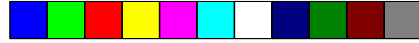

2. Remove the system unit cover. Refer to the manufacturer's instructions if necessary.
3. Remove expansion cards seated in any of the expansion slots and detach all connectors from the old system board.
4. Loosen the screws holding the original system board and remove the board from the system. Save the screws.
5. Remove the G586VPMR from its original packing box. Be careful to avoid touching all connectors and pins on the board. Please refer to the handling instructions on pages 9-10 for proper handling techniques.
6. Insert the SIMMs into the SIMM banks on the G586VPMR. The quantity and location of the SIMMs is dependent upon the memory configuration and type of modules you intend to use.
7. Insert the cache module, if any, into the cache module slot on the G586VPMR.
8. Install the CPU. Be sure pin 1 of the CPU is aligned with pin 1 of the socket.
9. Set the corresponding jumpers.
10. Install the prepared G586VPMR system board into the case and replace the screws.
11. Reinstall all cards and connectors and replace the system unit cover. Reconnect all power cords and cables.

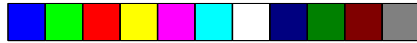

## Board Layout

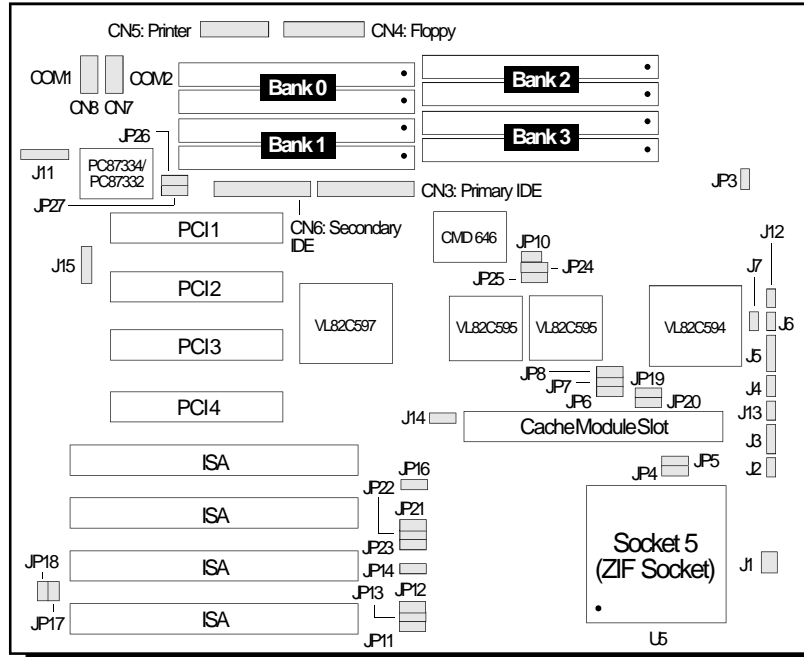

- Pin 1 of the socket

## System Memory

The G586VPM/R system board can support 4MB to 512MB of memory using 72-pin SIMMs (Single In-line Memory Module). A SIM module consists of several RAM chips soldered onto a small circuit board.

The SIM sockets are divided into four banks on the system board. Each bank consists of 2 SIMM sockets. You can insert single-sided or double-sided SIM modules to any of the banks located on the system board. You can also populate one SIM module in a bank to allow smaller upgrade increments.

The G586VPM/R system board uses 256KBx32/36, 512KBx32/36, 1MBx32/36, 2MBx32/36, 4MBx32/36, 8MBx32/36 and 16MBx32/36 SIMM modules. Your system board can be configured with 4MB, 6MB, 8MB, 12MB, 16MB, 24MB, 32MB, 48MB, 64MB, 96MB, 128MB, 192MB,

256MB or 512MB of onboard memory. Please refer to page 12 for the locations of the SIMM sockets.

### Installing a SIM Module

A SIM module simply snaps into a socket on the system board. Pin 1 of the SIM module must correspond with Pin 1 of the socket.

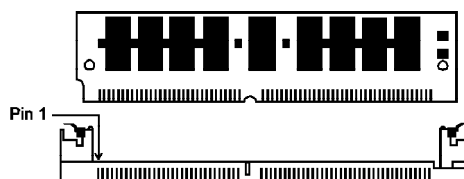

1. Position the SIMM above the socket with the “notch” in the module aligned with the “key” on the socket.
2. Seat the module at a 45° angle into the bank. Make sure it is completely seated. Tilt the module upright until it locks in place in the socket.

### Memory Configuration

Memory Size	Bank 0	Bank 1	Bank 2	Bank 3
4MB	256Kx36	256Kx36	—	—
4MB	512Kx36	—	—	—
6MB	256Kx36	256Kx36	256Kx36	—
8MB	256Kx36	256Kx36	256Kx36	256Kx36
8MB	512Kx36	512Kx36	—	—
8MB	1Mx36	—	—	—
12MB	512Kx36	512Kx36	512Kx36	—
16MB	512Kx36	512Kx36	512Kx36	512Kx36
16MB	1Mx36	1Mx36	—	—
16MB	2Mx36	—	—	—

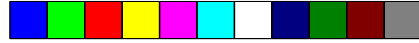

Memory Size	Bank 0	Bank 1	Bank 2	Bank 3
24MB	1Mx36	1Mx36	1Mx36	—
32MB	1Mx36	1Mx36	1Mx36	1Mx36
32MB	2Mx36	2Mx36	—	—
32MB	4Mx36	—	—	—
48MB	2Mx36	2Mx36	2Mx36	—
64MB	2Mx36	2Mx36	2Mx36	2Mx36
64MB	4Mx36	4Mx36	—	—
64MB	8Mx36	—	—	—
96MB	4Mx36	4Mx36	4Mx36	—
128MB	4Mx36	4Mx36	4Mx36	4Mx36
128MB	8Mx36	8Mx36	—	—
192MB	8Mx36	8Mx36	8Mx36	—
256MB	8Mx36	8Mx36	8Mx36	8Mx36
512MB	16Mx36	16Mx36	16Mx36	16Mx36

## Cache Memory

The G586VPM/R provides a cache module slot rather than a build-in cache. The system board can be configured to two different cache sizes: 256KB (default), and 512KB. Insert the cache module into the cache module slot. The system board is equipped with a 8Kx8 Tag RAM mounted on location U6. Please refer to page 12 for the locations of the cache module slot and U6.

Cacheable Memory Range	
256KB with 32-byte line size	0-64MB
512KB with 32-byte line size	0-128MB

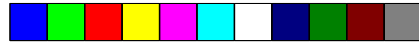

## Jumpers JP6-JP8, JP19, and JP20 Cache Memory

Jumpers JP6-JP8, JP19, and JP20 should be set according to the cache size as shown below.

	JP6	JP7	JP8	JP19	JP20
256KB with 32-byte line size*	1-2 On	1-2 On	1-2 On	1-2 On	1-2 On
512KB with 32-byte line size	2-3 On	2-3 On	2-3 On	1-2 On	1-2 On

\* Default setting

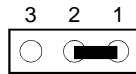

1-2: On

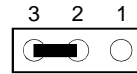

2-3: On

## Installing the Cache Module

Locate the 160-pin cache module slot on the system board. Position the cache module above the slot. Make sure pin 1 of the cache module is aligned with pin 1 of the slot. Carefully slide the module into the slot. Press firmly on the top of it to seat it properly.

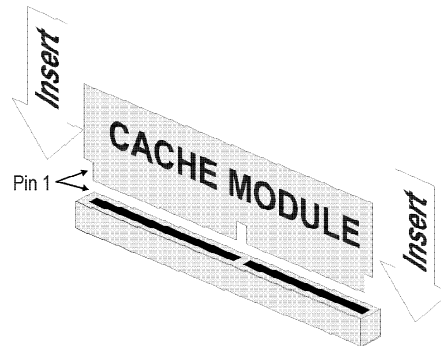

## CPU Installation

The G586VPMR is equipped with a 320-pin Zero Insertion Force (ZIF) socket at location U5 of the system board. The ZIF socket allows for easy installation of upgrade CPUs as your system needs grow. Make sure all jumpers are set correctly before applying power, or you may damage the CPU or system board. Refer to page 12 for the location of the ZIF socket.

### Jumper Settings for CPU

#### Jumpers J1, JP11 and JP12

CPU External Clock Speed and CPU Internal/External Speed Ratio

To allow optimum performance of your CPU, the CPU's external clock speed and its internal/external speed ratio must be set accordingly. For example, if you are using 100MHz Cyrix CPU, set external clock speed to 50MHz (J1) and set JP11/JP12 frequency ratio to 2, which is the recommended speed ratio of a 100MHz processor.

CPU Speed	CPU External Speed	Jumper J1		
		Pins 1-2	Pins 3-4	Pins 5-6
75MHz	50MHz	On	Off	Off
90MHz	60MHz	On	Off	On
100MHz	50MHz	On	Off	Off
100MHz	66MHz	On	On	On
110MHz	55MHz	On	On	Off
120MHz	60MHz	On	Off	On
133MHz	66.66MHz	On	On	On
150MHz	60MHz	On	Off	On
166MHz	66MHz	On	On	On



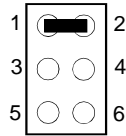
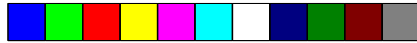

1-2 On

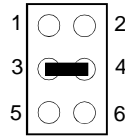

3-4 On

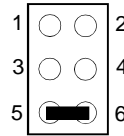

5-6 On

CPU Speed	CPU External Speed	Frequency Ratio	JP11	JP12
75MHz	50MHz	1.5x	2-3 On	2-3 On
90MHz	60MHz	1.5x	2-3 On	2-3 On
100MHz	50MHz	2x	2-3 On	1-2 On
100MHz	66MHz	1.5x	2-3 On	2-3 On
110MHz	55MHz	2x	2-3 On	1-2 On
120MHz	60MHz	2x	2-3 On	1-2 On
133MHz	66.66MHz	2x	2-3 On	1-2 On
150MHz	60MHz	2.5x	1-2 On	1-2 On
166MHz	66MHz	2.5x	1-2 On	1-2 On

Only Cyrix CPU supports 110MHz.

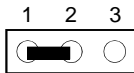

1-2: On

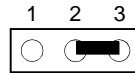

2-3: On

**Frequency Ratio:**

“1.5” refers to 1.5 times the speed of the CPU’s external clock speed.

“2” refers to twice the speed of the CPU’s external clock speed.

“2.5” refers to 2.5 times the speed of the CPU’s external clock speed.

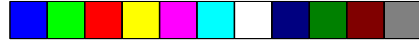

### Jumper JP3 CPU Voltage Select

Set Jumper JP3 according to the voltage of the CPU installed on the G586VPMR system board.

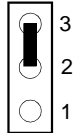

1-2 On: 3.45V - 3.6V

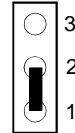

2-3 On: 3.3V - 3.45V  
(Default)

### Installing Upgrade CPUs

The G586VPMR is equipped with a 320-pin Zero Insertion Force (ZIF) socket at location U5 of the system board. This socket is designed for easy removal of an old CPU and easy insertion of an upgrade CPU. The socket allows you to carefully place the new CPU into its position. If you need to apply excessive force to insert the CPU, you are not installing the CPU correctly.

#### **Warning:**

*Open the socket only if you are actually installing a CPU. The warranty on the original CPU will be voided if the S/N seal is broken.*

*Before proceeding with the upgrade, take note of the following. The microprocessor and heat sink may be hot if the system has been running. To avoid the possibility of a burn, power the system off and let the processor and heat sink cool for 10 minutes.*

The 320-pin ZIF socket consists of five rows of pin holes on each side. To prevent improper CPU installation, the ZIF socket has a Plug/Keying mechanism. Several holes in the socket are plugged so that CPUs will go in only one way. If you cannot easily insert the CPU, verify that pin 1 of the CPU is aligned with pin 1 of the socket. A warning note — be extremely careful to match pin 1 of the CPU with pin 1 of the socket. Usually pin 1 of the CPU is marked by a dot or a cut corner.

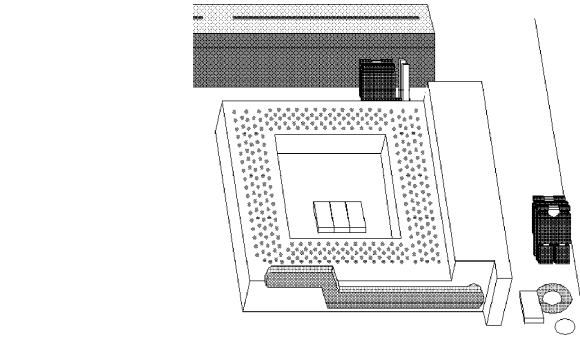

### Zero Insertion Force (ZIF) Socket

To install an upgrade CPU, do the following.

1. Make sure the handle on the side of the ZIF socket is up. To raise the handle, push it down, slightly pull it out to the side, then raise it as far as it will go. The top plate will slide back. Do not use screwdrivers or other tools to open the socket, or you may damage the system or socket. It may be necessary to initially apply a small amount of sideways force to free the handle from its retaining "tab." Once clear of the "tab," the handle will open relatively easily.

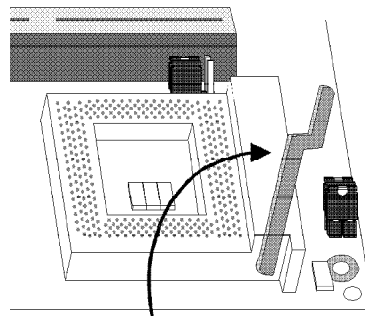

Handle

### Lifting the Handle

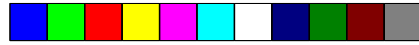

2. Once the lever is completely up, remove the old CPU carefully by lifting it straight out of the socket. You are now ready to insert the new CPU.

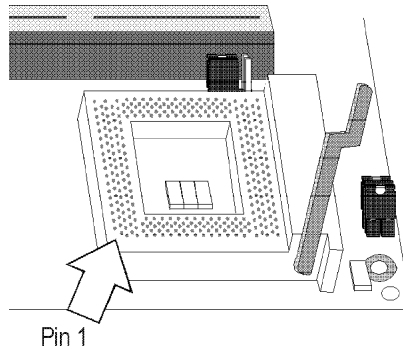

3. Position the CPU above the ZIF socket. Make sure pin 1 of the CPU is aligned with pin 1 of the socket. Lower the chip until the pins are inserted properly in their corresponding holes. Remember that very little force is needed to install the CPU. If the CPU is not easily inserted, verify whether or not pin 1 of the CPU is aligned with pin 1 of the socket. Applying too much pressure can damage the CPU or the socket.

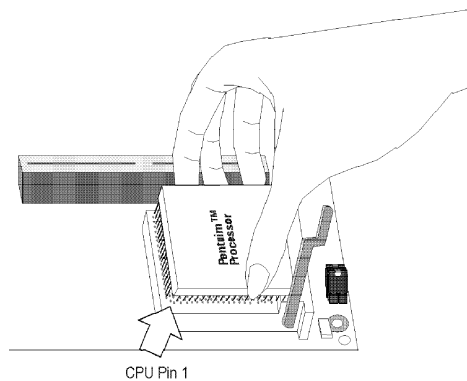

### Positioning the CPU Above the ZIF Socket



4. Push the handle down until the handle locks into place. The top plate will slide forward. You will feel some resistance as the pressure starts to secure the CPU in the socket. This is normal and will not damage the CPU. However, if the handle is not completely closed, damage to the CPU and/or system board may result.

### **Clearance Requirements**

Your CPU comes with a heat sink mounted on top. To maintain proper airflow once the upgrade is installed on the system board, the CPU and heatsink require certain space clearances.

The clearance above the CPU's fan/heat-sink must be at least 0.4 inches. The clearance on at least 3 of 4 sides of the CPU must be at least 0.2 inches. The cables (for floppy drive, hard drive, CD-ROM, etc.) must be routed clear of the CPU and its airspace.

### **Fan Exhaust**

The CPU must be kept cool by using a fan exhaust configuration in connection with the heatsink. The temperature of the air entering the fan/heatsink cannot exceed 45°C (113°F). The ambient or room temperature must be below 37°C (99°F).

In order to provide proper airflow to the CPU, all movable obstructions (power supply cables, cards, floppy disk cables) must be clear of the CPU fan/heatsink component in accordance with the space clearance discussed in the Clearance Requirements section of this manual.



## Jumper Settings for PCI Slot 4

### Jumpers JP24 and JP25

#### PCI Slot 4 Master/Slave Select

PCI Slot 4 of the G586VPMR system board supports Master and Slave modes. If a Master add-in card is installed in PCI Slot 4, the IDE driver's DMA mode must be set to "Disabled." Set Jumpers JP24 and JP25 as shown below.

	JP24	JP25
PCI Slot 4 installed with Master add-in card Onboard PCI IDE must be set to PIO mode	2-3 On	2-3 On
PCI Slot 4 installed with Slave add-in card Onboard PCI IDE can be set to PIO or DMA mode*	1-2 On	1-2 On

\* Default setting

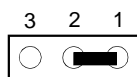

1-2 On

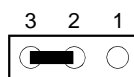

2-3 On

## Jumper Settings for Parallel Port

### Jumpers JP26 and JP27

#### SPP/EPP/ECP Printer Port DMA Channel Select

Jumpers JP26 and JP27 are used to select the SPP/EPP/ECP Printer port's DMA Channel. The G586VPM/R system board supports DMA Channel 1 or 3. Set JP26 and JP27 according to the DMA channel used by the system board.

DMA Channel	JP26	JP27
DMA 1*	1-2 On	1-2 On
DMA 3	2-3 On	2-3 On

\* Default setting

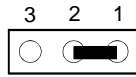
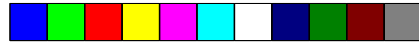

1-2 On

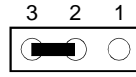

2-3 On

## Jumper Settings for Display

### Jumper JP17

Display Type Select

Jumper JP17 sets the display adapter to color or mono. This jumper must match the type of display adapter installed. If you change your video adapter, make sure this jumper is changed accordingly.



On: Color  
(Default)



Off: Mono

## Jumper Settings for PS/2 Mouse

### Jumper JP18

PS/2 Mouse

The G586VPMR package includes a card-edge bracket with serial and mouse port. The PS/2 mouse port uses IRQ12. If you set Jumper JP18 to "IRQ12 Enabled," make sure you connect the PS/2 mouse port to Connector J11. When IRQ12 is disabled and a PS/2 mouse is not used, the IRQ12 interrupt is available for other devices.



On: IRQ12 Enabled  
(Default)



Off: IRQ12  
Disabled



## Factory Testing Jumpers

The jumpers below are for factory testing only and should always be set to their default configurations. Reconfiguring these jumpers will cause problems with your system board.

**JP21-JP23:** Off  
**JP10:** Off  
**J14, JP14 and JP16:** 1-2 On  
**JP4, JP5 and JP13:** 2-3 On

## Built-in Ports

The G586VPM/R system board is equipped with two serial ports, one ECP/EPP parallel printer port, one FDD connector, two IDE hard disk connectors, and one PS/2 mouse port. Please refer to page 12 for the locations of the built-in ports.

## Serial Ports

The built-in serial ports are RS-232C asynchronous communication ports with NS16C550-compatible UARTs that can be used with modems, serial printers, remote display terminals, and other serial devices. The G586VPM/R system board supports IRQ4 for the primary serial port and IRQ3 for the secondary serial port. These serial ports use the following system I/O addresses:

Port Configuration	I/O Address
COM1	3F8h
COM2	2F8h

## Connecting the Serial Ports

Two DB-9P serial port cables are provided with the system board. They are mounted on a card-edge bracket along with the PS/2 mouse cable. The upper serial port cable should be used for the COM-A primary serial port; connect it to Connector CN8 on the system board. The lower serial port cable should be used for the COM-B secondary serial port; connect it to Connector CN7 on the system board. Make sure the col-





ored stripes on the ribbon cables align with pin 1 of Connectors CN7 and CN8. Mount the card-edge bracket to the system chassis.

### PS/2 Mouse Port

The PS/2 mouse port is a 6-pin connector on the G586VPM/R system board. Attach the 6-pin mouse port cable, which came in the G586VPM/R box, to connector J11. Make sure the brown wire on the PS/2 mouse connector aligns with pin 1 of connector J11. The other end of the wires are attached to the card-edge bracket that also holds the two serial port cables.

### Parallel Port

The G586VPM/R system board has a standard connector to a parallel printer. This port is compatible with both IBM AT printer ports and the new, high speed, bi-directional Extended Capabilities Port standard. The parallel port on your system board can be set to any of the following system I/O addresses:

Port Configuration	I/O Address
LPT 1	3BC-3BE Hex
LPT 2	378-37A Hex
LPT 3	278-27A Hex

### Connecting the Parallel Printer Port

Attach the DB-25S printer port cable, which came with the system board, to Connector CN5 on the G586VPM/R system board. Make sure the colored stripe on the ribbon cable aligns with pin 1 of Connector CN5. Use a small nutdriver to mount the cable into a DB-25 cutout in the system chassis.

### Floppy Disk Drive Controller

The G586VPM/R system board has a built-in floppy disk controller that supports two standard floppy disk drives. You can install any 720KB, 1.2MB, 1.44MB, or 2.88MB floppy disk drives.

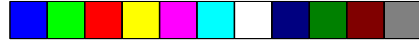

## Connecting the Floppy Disk Cable

1. Install the 34-pin header connector into the floppy disk connector (CN4) on the G586VPM/R system board with the colored edge of the ribbon aligned to pin 1.
2. Install the other 34-pin header connector(s) into the disk drive(s) with the colored edge of the daisy chained ribbon cable aligned to pin 1 of the drive edge connector(s). The end-most connector should be attached to the drive you want to be Drive A.

## IDE Hard Disk Interface

The G586VPM/R system board is equipped with two PCI IDE connectors that will interface four IDE (Integrated Drive Electronics) hard disk drives. An IDE drive is a hard drive with the controller electronics built into the disk assembly. The integration of the controller and the drive as a single unit increases reliability and performance by eliminating redundant circuitry.

### Note:

*Only IDE drives can be connected to the IDE interface.*

## Connecting the IDE Hard Disk Interface

1. If you are connecting two hard drives, install the 40-pin connector of the IDE cable into the primary disk connector (CN3). If you are adding a third or fourth IDE device, install the 40-pin connector of the other IDE cable into the secondary connector (CN6). Make sure the colored edge of the ribbon is aligned to pin 1.
2. Install the other 40-pin header connector(s) into the device with the colored edge of the ribbon cable aligned to pin 1 of the drive edge connector(s).

### Note:

*Refer to your disk drive user's manual for information about selecting proper drive switch settings.*

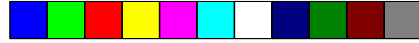

## Adding a Second IDE Hard Drive

When using two IDE drives, one must be set as the master and the other as the slave. Follow the instructions provided by the drive manufacturer for setting the jumpers and/or switches on the drives. No changes are needed on the G586VPMR system board when adding a second hard drive.

We recommend that the IDE hard drives be from the same manufacturer. In a few cases, drives from two manufacturers will not function properly when used together. The problem lies in the hard drives, not the G586VPMR system board.

## Preparing an IDE Drive for Use

IDE disk drives are already low-level formatted, with any bad-track errors entered, when shipped by the drive manufacturer. Do not attempt to do a low-level format, or you may cause serious damage to the drive.

To use an IDE drive, you need to enter the drive type (this information is provided by the drive manufacturer) into the system's CMOS setup table. Then run FDISK and FORMAT provided with DOS.

### Note:

*Do not run FDISK and FORMAT programs on a drive that has already been formatted, or you will lose all programs and data stored on the drive.*

## Installing Expansion Cards

The G586VPMR is equipped with three dedicated PCI and three dedicated ISA slots. One PCI slot and one ISA slot are shared. You can only install a card in one or the other of the shared slots at a time, you cannot install devices in both slots. The location of the expansion slots are shown below.

### Note:

*The BIOS needs to be configured for the PCI add-on cards installed in the PCI slots. Refer to the PCI Configuration Setup on pages 33 and 34 for more information.*



## Chapter 3 Initial Setup Program

---

After you power up your system, the BIOS message appears on your screen and the memory count begins.

After the memory test, the following message will appear on the screen:

*Press DEL to enter setup*

If the message disappears before you respond, restart your system or press the “Reset” button. You may also restart the system by pressing the <Ctrl> <Alt> <Del> keys simultaneously. If you do not press these keys at the correct time and the system does not boot, the following error message will appear:

*Press Del to enter Setup*

If you have set a password and selected “System” in the Security Option of the BIOS Feature Setup menu, you will be prompted for the password everytime the system is rebooted or any time you try to enter Setup. Type in the correct password and press <Enter>.

If you selected “Setup” in the Security Option, you will be prompted for the password only when you try to enter Setup. Refer to the “BIOS Features Setup” section for more information.

### Award BIOS CMOS Setup Utility

Press <Ctrl> <Alt> <Esc> simultaneously or <Del> to enter the Setup utility. A screen similar to the one on the next page will appear.

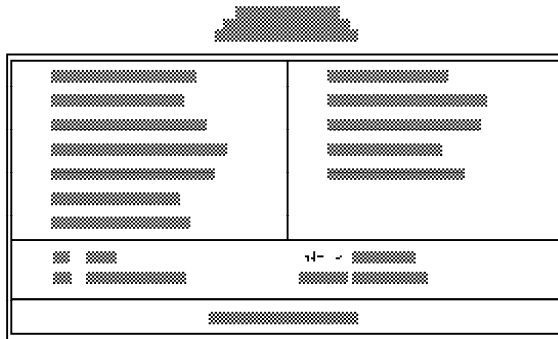
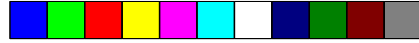

Use the arrow keys to highlight the option you want and press <Enter>.

### Standard CMOS Setup

Use the arrow keys to highlight “Standard CMOS Setup” and press <Enter>, a screen similar to the one below will appear.

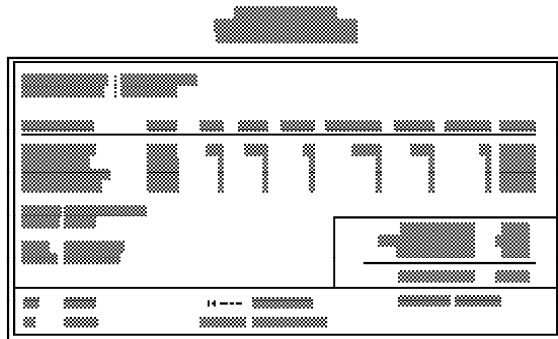

### Date and Time

Sets the time and date for the system. Press <F3> for the calendar.

### Hard Drive Type

If you have added an IDE drive, you must select the appropriate type for the drive. You may use the “IDE HDD Auto Detection” from the main CMOS setup menu or you can set it manually. The G586VPMR has 46 pre-set types and one user-definable type. Use the <Page Up> or <Page Down> keys to select the appropriate type for the drive.

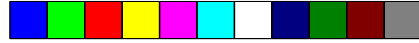

The table in Appendix G gives a complete listing of the available drive types. Any given drive must be set to one specific drive-type number. Please refer to your IDE drive documentation to find the appropriate type number.

If none of the pre-set types are appropriate for your drive, choose "User", which is the user-definable type. To use this type, highlight either the drive you want to set: Primary Master, Primary Slave, Secondary Master or Secondary Slave. Use the arrow keys until type "User" is showing. Fill in all the parameters as specified by the drive manufacturer. If a drive is not installed, select "None" and press <Enter>.

### **Drive A and Drive B**

These options are used to select the type of floppy disk drives installed in your system. If either of the drives is not present, select "None." Make sure you choose the correct drive type; otherwise, your system might improperly format the device.

### **Video**

This is used to select the type of video adapter installed in your system.

### **Halt on**

The system will halt if an error is detected during power up.

No Errors: The system boot will not stop for any detected errors.

All Errors: The system will stop whenever the BIOS detects a non-fatal error.

All, But Keyboard: The system will stop for any errors except a keyboard error.

All, But Diskette: The system will stop for any errors except a disk error.

All, But Disk/Key: The system will stop for any errors except a keyboard or disk error.

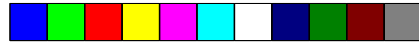

## Memory

The lower right hand corner shows the base memory size, extended memory size, and the other memory size of your system. You cannot alter these items; your computer automatically detects and displays them.

The Other Memory size refers to the memory located in the 4MB to 256MB address space. This is the memory used for different applications. DOS uses this area to load device drivers to keep as much base memory free for application programs. Most use this for the Shadow RAM.

When you are through making changes in the Standard CMOS Setup, press <Esc> to return to the main menu.

## BIOS Features Setup

Use the arrow keys to highlight "BIOS Features Setup" and press <Enter>, a screen similar to the one below will appear.

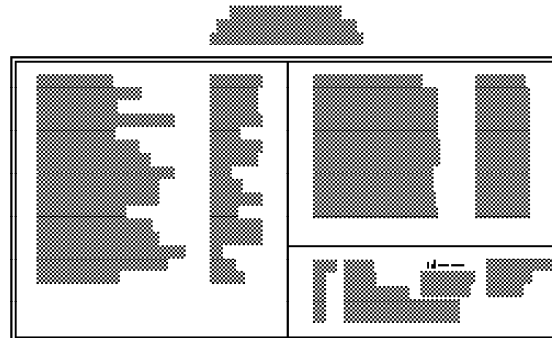

The Virus Warning option may be set to "Enabled" or "Disabled". When enabled, the BIOS issues a warning when any program or virus sends a Disk Format command or attempts to write to the boot sector of the hard disk drive.



If you choose "System" in the Security Option, you will be prompted for a password every time you cold boot your system or access setup. If you choose "Setup", you will be prompted for a password only when trying to access setup.

If the changes you made are incorrect or you change your mind, press <F6> or <F7> to return to the default settings. Press <Esc> after making the changes to return to the main menu.

### Chipset Features Setup

The G586VPM/R uses VLSI chipset. The Chipset Features Setup allows you to modify some functions to optimize system performance. It also allows you to enable, disable or select the port address of the built-in serial ports, parallel port, floppy disk controller and hard disk controller.

If you press <Enter>, a screen similar to the one below will appear.



Use the arrow keys to move the highlight bar to the option you wish to change or modify. Use the <Page Up>, <Page Down>, <+> or <-> keys to make the corresponding changes.

If the changes you made are incorrect or you change your mind, press <F6> or <F7> to return to the default setting.







## Power Management Setup

Use the arrow keys to highlight the “Power Management Setup” and press <Enter>, a screen similar to the one below will appear.

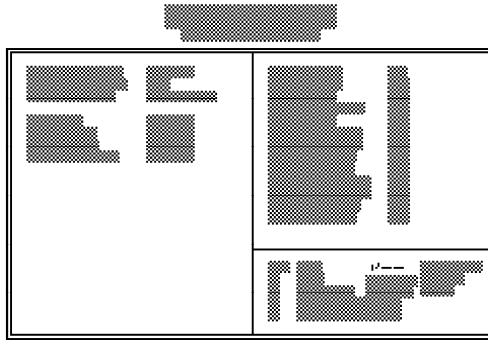

The above Power Management Setup configuration will not use any of the power management features at all since Power Management is disabled.

Choosing “User Defined” in the Power Management option will allow you to set the time of the power management features. “Min Power Saving” and “Max Power Saving” will set the minimum and maximum value of these options respectively. Choose “Disabled” if you do not wish your system to enter the power saving mode.

If you want your computer to resume an IRQ event, you can enable that IRQ. For example, if you have a network card installed that uses IRQ 5, you may want to turn IRQ 5 to On to allow the computer to resume when the network polls the system.

## PCI Configuration Setup

Use the arrow keys to highlight “PCI Configuration Setup” and press <Enter>, a screen similar to the one on the next page will appear.



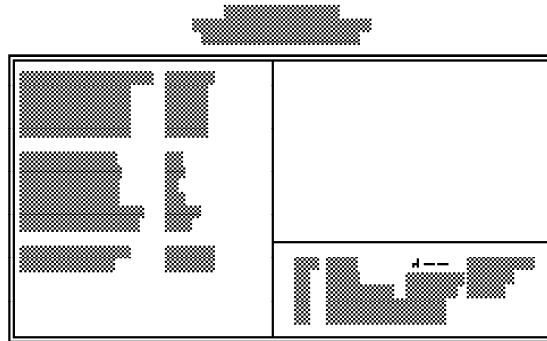
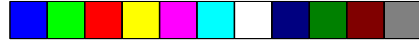

The G586VPMR system board supports four PCI master/slave slots. Each slot may be assigned INT A, B, C, D or Auto if the card installed in the slot requires an interrupt. Each INT may then be assigned an IRQ value.

**Note:**  
*We recommend that you assign all slots to Auto.*

### Load BIOS Defaults

If, for some reason, the CMOS becomes corrupted, the system can be reconfigured with the default values stored in the ROM chips. The BIOS default values provide the slowest performance for the system but are stable. You should use these values only if you are having hardware problems.

Highlight this option on the main menu and press <Enter>. The message below will appear.

*Load BIOS Defaults (Y/N)? N*

Type "Y" and press <Enter> to load the BIOS setup default values. After pressing <Enter>, you will be returned to the main menu.

### Load Setup Defaults

The Setup default values are stable and optimized for standard configuration. These defaults must be selected as standard values for your system.



Highlight this option on the main menu and press <Enter>. The message below will appear.

*Load Setup Defaults (Y/N)? N*

Type “Y” and press <Enter> to load the Setup default values. After pressing <Enter>, you will be returned to the main menu.

To configure your system for optimum performance, you must reset the options under the Chipset Features Setup. However, you are allowed to do so under the instruction of a technical engineer, otherwise, failure may occur.

### **Password Setting**

If you want to set a password, make sure that the Security Option under the BIOS Features Setup is set to “System” or “Setup”. Refer to the BIOS Features Setup option for more information.

Use the arrow keys to highlight the Password Setting option and press <Enter>. The message below will appear.

*Enter Password:*

Type in the password. You are limited to eight characters. Type in a password that is eight characters long or shorter. When done, the message below will appear:

*Confirm Password:*

You are asked to verify the password. Type in exactly the same password. If you type in a wrong password, you will be prompted to enter the correct password again. Otherwise, enter a new password.

To delete or disable the password function, simply press <Enter> instead of typing in a new password. Press the <Esc> key to return to the main menu.



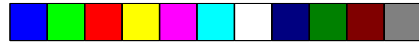

### IDE HDD Auto Detection

This option detects the hard disk parameters for the hard disk drives installed in your system. Highlight this option and press <Enter>. A screen similar to the one below will appear.

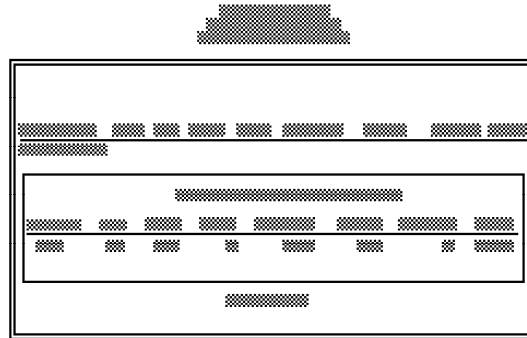

The screen displays the parameters detected and allows you to accept or reject the parameters. Type "Y" and press <Enter> to accept the parameters or press <Esc> to abort. If you select "Y", the parameters of the hard disk will be displayed in the Standard CMOS Setup.

### HDD Low Level Format

This option will format, set the interleave mode and do a media analysis of your hard drives. Highlight this option and press <Enter>. A screen similar to the one below will appear.

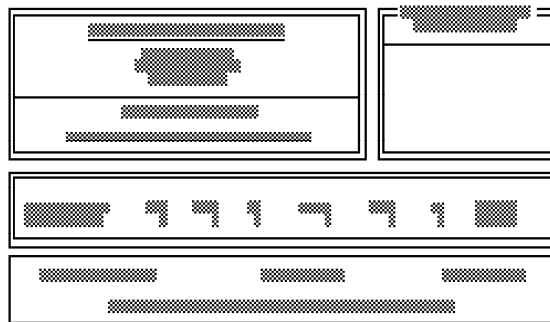

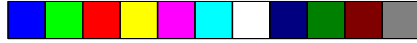

**Warning:**

*Do not attempt to do a low-level format, or you may cause serious damage to the drive. IDE disk drives are already low-level formatted, with any bad-track errors entered, when shipped by the drive manufacturer.*

Use the arrow keys to select an option and press <Enter> to accept the option. Press <Esc> when done.

### Save & Exit Setup

When all the changes have been made, highlight “Save & Exit Setup” and press <Enter>. The following message will appear:

*Save to CMOS and Exit (Y/N)? N*

Type “Y” and press <Enter>. The following message will appear:

*Reboot System (Y/N)? N*

Type “Y” and press <Enter>. The modifications you have made will be written into the CMOS memory, and the system will reboot. You will once again see the initial diagnostics on the screen. If you wish to make additional changes to the setup, press <Ctrl> <Alt> <Esc> simultaneously or <Del> after the memory testing is completed.

### Exit Without Saving

When you do not want to save the changes you have made, highlight this option and press <Enter>. The following message will appear:

*Quit Without Saving (Y/N)? N*

Type “Y” and press <Enter>. The system will reboot and you will once again see the initial diagnostics on the screen. If you wish to make any changes to the setup, press <Ctrl> <Alt> <Esc> simultaneously or <Del> after the memory testing is completed.



## IDE Device Drivers

To install the IDE device drivers supported by the G586VPM/R board, please refer to the "Readme" file contained in the provided diskette.



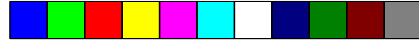

## Chapter 4 Troubleshooting Checklist

---

If you experience difficulty with the G586VPM/R system board, please refer to the checklist below. If you still cannot isolate the problem, please contact your dealer.

1. Check the jumper settings to ensure that the jumpers are properly set. If in doubt, refer to the “Hardware Installation” section.
2. Verify that all SIM modules are seated securely into the bank sockets.
3. Make sure that the SIM modules are in the correct locations.
4. Check that all populated memory banks are filled with valid size SIM modules.
5. If your board fails to function, place the board on a flat surface and seat all socketed components (gently press each component into the socket).
6. If you made changes to the BIOS settings, re-enter setup and load the BIOS defaults.

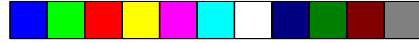

## Appendix A Types of Modules

---

The G586VPM/R system board allows you to populate memory with 256Kx36, 512Kx36, 1Mx36, 2Mx36, 4Mx36 and 8Mx36 SIM modules. The following modules have been tested with this board. Most untested brands will work but a few may fail to do so.

### For SIM 256Kx36 Modules

Brand	Chip Number
OKI	M51C256A-70

### For SIM 512Kx36 Modules

Brand	Chip Number
OKI	M514256B-70J

### For SIM 1Mx36 Modules

Brand	Chip Number
Toshiba	TC511000AJL
OKI	GT-1M*36B
Fujitsu	81C1000A-70

### For SIM 2Mx36 Modules

Brand	Chip Number
OKI	M511000B





**For SIM 4Mx36 Modules**

Brand	Chip Number
OKI	M514100A-70S

**For SIM 8Mx36 Modules**

Brand	Chip Number
OKI	M514100AL-70K





## Appendix B System Error Report

---

When the BIOS encounters an error that requires the user to correct something, either a beep code will sound or a message will be displayed in a box in the middle of the screen and a message PRESS F1 TO CONTINUE, CTRL-ALT-ESC or DEL TO ENTER SETUP will be shown in the information box at the bottom.

### POST Beep

Currently, there is only one beep code in BIOS. This code indicates that a video error has occurred and the BIOS cannot initialize the video screen to display any additional information. This beep code consists of a single long beep followed by two short beeps.

### Error Messages

One or more of the following messages may be displayed if the BIOS detects an error during the POST.

#### **CMOS BATTERY HAS FAILED**

CMOS battery is no longer functional. It should be replaced. The replacement battery is a Lithium watch battery, 3 Volt or equivalent. Replacing the battery will clear the CMOS and return the CMOS settings to the default values.

#### **CMOS CHECKSUM ERROR**

Checksum of CMOS is incorrect. This can indicate that CMOS has become corrupt. This error may have been caused by a weak battery. Check the battery and replace if necessary.

#### **DISK BOOT FAILURE, INSERT SYSTEM DISK AND PRESS ENTER**

No boot device was found. Insert a system disk into Drive A and press <Enter>. Assuming the system is booted from the hard drive, make sure the controller is inserted correctly and all cables are properly attached. Also, be sure the disk is formatted as a boot device. Then reboot the system.

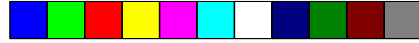

#### **DISKETTE DRIVES OR TYPES MISMATCH ERROR - RUN SETUP**

The type of diskette drive installed in the system is different from the CMOS definition. Run setup to reconfigure the drive type correctly.

#### **DISPLAY SWITCH IS SET INCORRECTLY**

Display switch on the motherboard can be set to either monochrome or color. This indicates the switch is set to a different setting than indicated in Setup. Determine which setting is correct, and then either turn off the system and change the jumper, or enter Setup and change the VIDEO selection.

#### **DISPLAY TYPE HAS CHANGED SINCE LAST BOOT**

Since last powering off the system, the display adapter has been changed. You must configure the system for the new display type.

#### **ERROR ENCOUNTERED INITIALIZING HARD DRIVE**

Hard drive cannot be initialize. Be sure the adapter is installed correctly and all cables are correctly and firmly attached. Also, be sure the correct hard drive type is selected in Setup (refer to Appendix G).

#### **ERROR INITIALIZING HARD DISK CONTROLLER**

Cannot initialize controller. Make sure the card is correctly and firmly installed in the bus. Be sure the correct hard drive type is selected in Setup. Also, check to see if any jumper needs to be set correctly on the hard drive.

#### **FLOPPY DISK CNTRLR ERROR OR NO CNTRLR PRESENT**

Cannot find or initialize the floppy drive controller. Make sure the controller is installed correctly and firmly. If there are no floppy drives installed, be sure the Diskette Drive selection in Setup is set to NONE.

#### **KEYBOARD ERROR OR NO KEYBOARD PRESENT**

Cannot initialize the keyboard. Make sure the keyboard is attached correctly and no keys are being pressed during the boot.

If you are purposely configuring the system without a keyboard, set the error halt condition in Setup to HALT ON ALL, BUT KEYBOARD. This will cause the BIOS to ignore the missing keyboard and continue the boot.

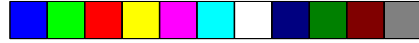

#### **MEMORY ADDRESS ERROR AT...**

Indicates a memory address error at a specific location. You can use this location along with the memory map for your system to find and replace the bad memory chips.

#### **MEMORY PARITY ERROR AT...**

Indicates a memory parity error at a specific location. You can use this location along with the memory map for your system to find and replace the bad memory chips.

#### **MEMORY SIZE HAS CHANGED SINCE LAST BOOT**

Memory has been added or removed since the last boot. Enter Setup and enter the new memory size in the memory fields.

#### **MEMORY VERIFY ERROR AT...**

Indicates an error verifying a value already written to memory. Use the location along with your system's memory map to locate the bad chip.

#### **OFFENDING ADDRESS NOT FOUND**

This message is used in conjunction with the I/O CHANNEL CHECK and RAM PARITY ERROR messages when the segment that has caused the problem cannot be isolated.

#### **OFFENDING SEGMENT**

This message is used in conjunction with the I/O CHANNEL CHECK and RAM PARITY ERROR messages when the segment that has caused the problem has been isolated.

#### **PRESS A KEY TO REBOOT**

This will be displayed at the bottom screen when an error occurs that requires a reboot. Press any key and the system will reboot.

#### **PRESS F1 TO DISABLE NMI, F2 TO REBOOT**

When BIOS detects a Non-maskable Interrupt condition during boot, this will allow NMI to be disabled and continue to boot. You can also reboot the system with the NMI enabled.

#### **RAM PARITY ERROR - CHECKING FOR SEGMENT**

Indicates a parity error in Random Access Memory.



**SYSTEM HALTED, (CTRL-ALT-DEL) TO REBOOT...**

Indicates the present boot attempt has been aborted and the system must be rebooted. Press and hold down the CTRL and ALT keys and press DEL simultaneously.





## Appendix C Memory and I/O Maps

---

### Memory Address Map

Address	Name	Function
0000000 to 009FFFF	640K System Board RAM	System Board Memory
00A0000 to 00BFFFF	128K Video Display Memory	Reserved for Graphics Display Memory
00C0000 to 00DFFFF	192K I/O Expansion ROM	Reserved for ROM on I/O Adapter Card
00E0000 to 00FFFF	128K ROM on the System Board	System Board BIOS
0100000 to 3FFFFFF	Maximum Memory 128M	System Board Memory

---

## I/O Address Map

I/O Address	Function
000-01F	DMA Controller 1, 8237A-5
020-03F	Interrupt Controller 1, 8259A, Master
040-05F	Timer, 8254-2
060-06F	8742 (Keyboard and Mouse Controller)
070-07F	Real-time Clock, NMI (Non-maskable Interrupt) Mask
080-09F	DMA Page Memory, 74LS612
0A0-0BF	Interrupt Controller 2, 8259A
0C0-0DF	DMA Controller 2, 8237A-5
0E8	Shadow RAM and Cache Control Bit
0F0	Clear Numeric Processor Extension Busy
0F1	Reset Numeric Processor Extension
0F8-0FF	Numeric Processor Extension
1F0-1F8	Fixed Disk Control 1
170-178	Fixed Disk Control 2
200-207	Game I/O
278-27F	Parallel Printer Port 2
2F8-2FF	Serial Port 2
300-31F	Prototype Card
360-36F	Reserved
378-37F	Parallel Printer Port 1
380-38F	SDLC, Bisynchronous 2
3A0-3AF	Bisynchronous 1
3B0-3BF	Monochrome Display and Printer Adapter
3C0-3CF	Reserved
3D0-3DF	Color/Graphics Monitor Adapter
3F0-3F7	Diskette Controller
3F8-3FF	Serial Port 1

**Note:**

The I/O address hex 000 to 0FF are reserved for the system board I/O.  
Hex 100 to 3FF are available on the I/O channels.

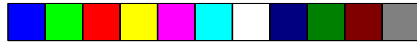

## Appendix D PCI I/O Pin Assignments

Component Side	B	A	Solder Side
	-12V	-01 -	TRST#
	TCK	-02 -	+12V
	Ground	-03 -	TMS
	TDO	-04 -	TDI
	+5V	-05 -	+5V
	+5V	-06 -	INTA#
	INTB#	-07 -	INTC#
	INTD#	-08 -	+5V
	PRSNT1#	-09 -	Reserved
	Reserved	-10 -	+5V (I/O)
	PRSNT2#	-11 -	Reserved
	Ground	-12 -	Ground
	Ground	-13 -	Ground
	Reserved	-14 -	Reserved
	Ground	-15 -	RST#
	CLK	-16 -	+5V (I/O)
	Ground	-17 -	GNT#
	REQ#	-18 -	Ground
	+5V (I/O)	-19 -	Reserved
	AD[31]	-20 -	AD[30]
	AD[29]	-21 -	+3.3V
	Ground	-22 -	AD[28]
	AD[27]	-23 -	AD[26]
	AD[25]	-24 -	Ground
	+3.3V	-25 -	AD[24]
	C/BE[3]#	-26 -	IDSEL
	AD[23]	-27 -	+3.3V
	Ground	-28 -	AD[22]
	AD[21]	-29 -	AD[20]
	AD[19]	-30 -	Ground
	+3.3V	-31 -	AD[18]
	AD[17]	-32 -	AD[16]
	C/BE[2]#	-33 -	+3.3V
	Ground	-34 -	FRAME#
	IRDY#	-35 -	Ground
	+3.3V	-36 -	TRDY#
	DEVSEL#	-37 -	Ground
	Ground	-38 -	STOP#
	LOCK#	-39 -	+3.3V
	PERR#	-40 -	SDONE
	+3.3V	-41 -	SBO#
	SERR#	-42 -	Ground
	+3.3V	-43 -	PAR
	C/BE[1]#	-44 -	AD[15]
	AD[14]	-45 -	+3.3V
	Ground	-46 -	AD[13]
	AD[12]	-47 -	AD[11]
	AD[10]	-48 -	Ground
	Ground	-49 -	AD[09]
	AD[08]	-52 -	C/BE[0]#
	AD[07]	-53 -	+3.3V
	+3.3V	-54 -	AD[06]
	AD[05]	-55 -	AD[04]
	AD[03]	-56 -	Ground
	Ground	-57 -	AD[02]
	AD[01]	-58 -	AD[00]
	+5V (I/O)	-59 -	+5V (I/O)
	ACK64#	-60 -	REQ64#
	+5V	-61 -	+5V
	+5V	-62 -	+5V



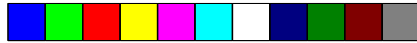

## Appendix E ISA I/O Pin Assignments

B		A
Grnd	- 01 -	-I/OChck
ResetDrv	- 02 -	SD7
+5VDC	- 03 -	SD6
IRQ9	- 04 -	SD5
-5VDC	- 05 -	SD4
DRQ2	- 06 -	SD3
-12VDC	- 07 -	SD2
OVS	- 08 -	SD1
+12VDC	- 09 -	SD0
Grnd	- 10 -	-I/OChrdy
-SEMEMW	- 11 -	AEN
-SEMEMR	- 12 -	SA19
-IOW	- 13 -	SA18
-IOR	- 14 -	SA17
-Dack3	- 15 -	SA16
-DRQ3	- 16 -	SA15
-Dack1	- 17 -	SA14
DRQ1	- 18 -	SA13
-Refresh	- 19 -	SA12
CLK	- 20 -	SA11
IRQ7	- 21 -	SA10
IRQ6	- 22 -	SA9
IRQ5	- 23 -	SA8
IRQ4	- 24 -	SA7
IRQ3	- 25 -	SA6
-Dack2	- 26 -	SA5
T/C	- 27 -	SA4
Bale	- 28 -	SA3
+5VDC	- 29 -	SA2
OSC	- 30 -	SA1
Grnd	- 31 -	SA0

D		C
-MemCS16	- 01 -	SBHE
-I/OCS16	- 02 -	LA23
IRQ10	- 03 -	LA22
IRQ11	- 04 -	LA21
IRQ12	- 05 -	LA20
IRQ13	- 06 -	LA19
IRQ14	- 07 -	LA18
-Dack0	- 08 -	LA17
DRQ0	- 09 -	-Memr
-Dack5	- 10 -	-Memw
DRQ5	- 11 -	SD08
-Dack6	- 12 -	SD09
DRQ6	- 13 -	SD10
-Dack7	- 14 -	SD11
DRQ7	- 15 -	SD12
+5VDC	- 16 -	SD13
-Master	- 17 -	SD14
Grnd	- 18 -	SD15



## Appendix F Connector Pin Assignments

---

### Connector J2 Reset Switch Connector

Pin	Function
1	Reset
2	Ground

### Connector J3 Speaker Connector

Pin	Function
1	Signal
2	None
3	Ground
4	+5V

### Connector J4 Turbo Switch Connector

Pin	Function
On	Low Speed
Off	Turbo (Normal) Speed

### Connector J5 Keylock Connector

Pin	Function
1	LED Signal
2	Reserved
3	Ground
4	Keylock Signal
5	Ground

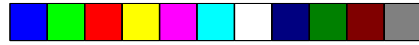

**Connector J6**  
PCI IDE LED

Pin	Function
1	LED (+)
2	LED (-)

**Connector J7**  
Disk Active

Pin	Function
1	Signal
2	Grd

**Connector J11**  
PS/2 Mouse Connector

Pin	Function
1	Mouse Data
2	Reserved
3	Ground
4	+5V
5	Mouse Clock
6	Reserved

**Connector J12**  
Green Function LED

Pin	Function
1	LED+
2	LED-

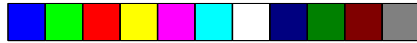

### Connector J13

Turbo LED

Pin	Function
1	LED-
2	LED+

### Connector J15

External Battery

Pin	Function
1	+3V
2	N.C.
3	N.C.
4	Ground

### Connectors CN3 and CN6

Primary and Secondary IDE Hard Disk Drive Connectors

Pin	Function	Pin	Function
1	-Reset	21	Reserved
2	Ground	22	Ground
3	D7	23	-IOW
4	D8	24	Ground
5	D6	25	-IOR
6	D9	26	Ground
7	D5	27	Reserved
8	D10	28	BALE
9	D4	29	Reserved
10	D11	30	Ground
11	D3	31	IRQ14
12	D12	32	IOCS16
13	D2	33	SA1
14	D13	34	Reserved
15	D1	35	SA0
16	D14	36	SA2
17	D0	37	HCS0
18	D15	38	HCS1
19	Ground	39	LED
20	Reserved	40	Ground

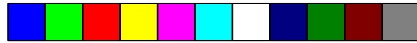

**Connector CN4**  
Floppy Disk Drive Connector

Pin	Function	Pin	Function
1	Ground	18	Dir
2	DENSEL	19	Ground
3	Ground	20	Step
4	Reserved	21	Ground
5	Ground	22	Write Data
6	Drate0	23	Ground
7	Ground	24	Write Gate
8	Index	25	Ground
9	Ground	26	Track 0
10	MTR0	27	MSEN
11	Ground	28	Wr Protect
12	DR1	29	Ground
13	Ground	30	Read Data
14	DR0	31	Ground
15	Ground	32	Head Select
16	MTR1	33	Ground
17	Drate1	34	Disk Change

**Connector CN5**  
Parallel Printer Port

Pin	Function	Pin	Function
1	-Strobe	14	-Autofd
2	Data 0	15	-Error
3	Data 1	16	-Init
4	Data 2	17	-Slctin
5	Data 3	18	Ground
6	Data 4	19	Ground
7	Data 5	20	Ground
8	Data 6	21	Ground
9	Data 7	22	Ground
10	-Ack	23	Ground
11	Busy	24	Ground
12	Paper Empty	25	Ground
13	Select		



### Connectors CN8 and CN7

Primary (COM-A) and Secondary (COM-B) Serial Ports

Pin	Function
1	DCD (Data Carrier Detect)
2	RX (Receive Data)
3	TX (Transmit Data)
4	DTR (Data Terminal Ready)
5	Ground (Signal Ground)
6	DSR (Data Set Ready)
7	RTS (Request to Send)
8	CTS (Clear to Send)
9	RI (Ring Indicator)

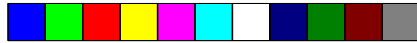

## Appendix G

### Award BIOS Hard Disk Table

Type	Size (MB)	Cylinders	Heads	Sectors	Write Precomp	Land Zone	Example Model
1	10	306	4	17	128	305	TEAC SD510, MMI 112, 5412
2	20	615	4	17	300	615	Seagate ST225, ST4026
3	30	615	6	17	300	615	
4	62	940	8	17	512	940	
5	46	940	6	17	512	940	
6	20	615	4	17	None	615	Seagate ST125, Tandon TM262
7	30	462	8	17	256	511	
8	30	733	5	17	None	733	Tandon TM 703
9	112	900	15	17	None	901	
10	20	820	3	17	None	820	
11	35	855	5	17	None	855	
12	49	855	7	17	None	855	
13	20	306	8	17	128	319	Disctron 526, MMI M125
14	42	733	7	17	None	733	
15	(Reserved)						
16	20	612	4	17	0	663	Microscience HH725, Syquest 3250, 3425
17	40	977	5	17	300	977	
18	56	977	7	17	None	977	
19	59	1024	7	17	512	1023	
20	30	733	5	17	300	732	

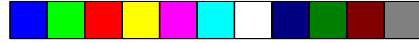

Type	Size (MB)	Cylinders	Heads	Sectors	Write Precomp	Land Zone	Example Model
21	42	733	7	17	300	732	
22	30	306	5	17	300	733	Seagate ST4038
23	10	977	4	17	0	336	
24	40	1024	5	17	None	976	Seagate ST4051
25	76	1224	9	17	None	1023	Seagate ST4096
26	71	1224	7	17	None	1223	Maxtor 2085
27	111	1224	11	17	None	1223	Maxtor 2140, Priam S14
28	152	1024	15	17	None	1223	Maxtor 2190, Priam S19
29	68	1024	8	17	None	1023	Maxtor 1085, Micropolis 1325
30	93	918	11	17	None	1023	Maxtor 1105, 1120, 4780
31	83	925	11	17	None	1023	Maxtor 1170
32	69	1024	9	17	None	926	CDC 9415
33	85	1024	10	17	None	1023	
34	102	1024	12	17	None	1023	
35	110	1024	13	17	None	1023	
36	119	1024	14	17	None	1023	
37	17	1024	2	17	None	1023	
38	136	1024	16	17	None	1023	
39	114	918	15	17	None	1023	Maxtor 1140, 4380
40	40	820	6	17	None	820	Seagate ST251
41	42	1024	5	17	None	1023	Seagate 4053, Miniscribe 3053/6053



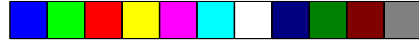

Type	Size (MB)	Cylinders	Heads	Sectors	Write Precomp	Land Zone	Example Model
42	65	1024	5	26	None	1023	Miniscribe 3053/ 6053 RLL
43	40	809	6	17	None	852	Miniscribe 3650
44	61	809	6	26	None	852	Miniscribe 3675 RLL
45	100	776	8	33	None	775	Conner CP3104
46	203	684	16	38	None	685	Conner CP3204
User Defined							



## Appendix H System Overview

### DMA Channels

DMA Controller 1	DMA Controller 2
Ch0-Reserved for User	Ch4-Cascade for CTRL 1
Ch1-ECP *	Ch5-Reserved for User
Ch2-Diskette	Ch6-Reserved for User
Ch3-Reserved for User	Ch7-Reserved for User

\* ECP DMA channel can be changed to Ch3 by using Jumpers JP26 and JP27 (see page 21 of the manual).

**Note:**

*DMA controller 1 supports 8-bit data transfer.*

*DMA controller 2 supports 16-bit data transfer.*

### Address Generation for DMA Channels 3 to 0

Source	DMA Page Memory	DMA Controller 1
Address	A23 < _____ > A16	A15 < _____ > A0

### Address Generation for DMA Channels 7 to 5

Source	DMA Page Memory	DMA Controller 2
Address	A23 < _____ > A17	A16 < _____ > A1

### Page Memory Address

IO Port Address	Page Memory
0081H	DMA Channel 2
0082H	DMA Channel 3
0083H	DMA Channel 1
0087H	DMA Channel 0
0089H	DMA Channel 6
008AH	DMA Channel 7
008BH	DMA Channel 5

## System Interrupts

Interrupt Controller 1	Interrupt Controller 2
IRQ0-Timer Output (Out 0)	IRQ8-Realtime Clock INT
IRQ1-Keybaord (Output Buffer Full)	IRQ9-Software Redirected to INT 0AH (IRQ2)
IRQ2-Interrupt from INTR2	IRQ10-Reserved
IRQ3-Serial Port 2	IRQ11-Reserved
IRQ4-Serial Port 1	IRQ12-PS/2 Mouse
IRQ5-Parallel Port 2 or 3 *	IRQ13-Coprocessor
IRQ6-Diskette Controller	IRQ14-Primary Fixed Disk Controller (1F0)
IRQ7-Parallel Port 1 or 2 *	IRQ15-Secondary Fixed Disk Controller (170) / Green IRQ **

\* The on-board parallel port can be configured to either Parallel Port 1, 2 or 3. The Parallel Port 1 uses I/O address 3BCh, Parallel Port 2 I/O address 378h, while Parallel Port 3 uses I/O address 278h.

\*\* If you enable the Green function in the CMOS Setup while using a non-green CPU, it will occupy IRQ15.

### Note:

The 16 levels of system interrupts have the following priority:

~~IRQ0>IRQ1>IRQ3>IRQ9>IRQ10>IRQ11>IRQ12>IRQ13>IRQ14>IRQ15>IRQ3>IRQ4>IRQ5>IRQ6>IRQ7.~~

## System Timers

Channel 0	System Timer (IRQ0)
Channel 1	Refresh Request Generator (15us Rate Generator Period Signal)
Channel 2	Tone Generation for Speaker



## Real-Time Clock

Address	Function
00	Seconds
01	Second Alarm
02	Minutes
03	Minute Alarm
04	Hours
05	Hour Alarm
06	Day of Week
07	Date of Month
08	Month
09	Year
0A	Register A
0B	Register B
0C	Register C
0D	Register D

---

