

P5XV3+

Rev. A+

**System Board
Carte Mère Manuel
System-Platine**

**User's Manual
Pour Utilisateur
Benutzerhandbuch**

Copyright

This publication contains information that is protected by copyright. No part of it may be reproduced in any form or by any means or used to make any transformation/adaptation without the prior written permission from the copyright holders.

This publication is provided for informational purposes only. The manufacturer makes no representations or warranties with respect to the contents or use of this manual and specifically disclaims any express or implied warranties of merchantability or fitness for any particular purpose. The user will assume the entire risk of the use or the results of the use of this document. Further, the manufacturer reserves the right to revise this publication and make changes to its contents at any time, without obligation to notify any person or entity of such revisions or changes.

© 1998. All Rights Reserved.

Trademarks

Microsoft® MS-DOS®, Windows™ and Windows® 95 are registered trademarks of Microsoft Corporation. Intel and Pentium are registered trademarks of Intel Corporation. Cyrix, 6x86, 6x86L, 6x86MX and M II are registered trademarks of Cyrix Corporation. AMD, K5, K6 and K6-2 are registered trademarks of Advanced Micro Devices, Inc. IBM is a registered trademark of International Business Machine Corporation. IDT C6 and WINCHIP2 are registered trademarks of IDT Corporation. Award is a registered trademark of Award Software, Inc. Other trademarks and registered trademarks of products appearing in this manual are the properties of their respective holders.

Caution:

Danger of explosion if battery incorrectly replaced.

Replace only with the same or equivalent type recommended by the manufacturer.

Dispose of used batteries according to the battery manufacturer's instructions.

FCC and DOC Statement on Class B

This equipment has been tested and found to comply with the limits for a Class B digital device, pursuant to Part 15 of the FCC rules. These limits are designed to provide reasonable protection against harmful interference when the equipment is operated in a residential installation. This equipment generates, uses and can radiate radio frequency energy and, if not installed and used in accordance with the instruction manual, may cause harmful interference to radio communications. However, there is no guarantee that interference will not occur in a particular installation. If this equipment does cause harmful interference to radio or television reception, which can be determined by turning the equipment off and on, the user is encouraged to try to correct the interference by one or more of the following measures:

- Reorient or relocate the receiving antenna.
- Increase the separation between the equipment and the receiver.
- Connect the equipment into an outlet on a circuit different from that to which the receiver is connected.
- Consult the dealer or an experienced radio TV technician for help.

Notice:

1. The changes or modifications not expressly approved by the party responsible for compliance could void the user's authority to operate the equipment.
2. Shielded interface cables must be used in order to comply with the emission limits.

Table of Contents / Sommaire / Inhaltsverzeichnis

Chapter 1 - Introduction

1.1 Features and Specifications.....	4
1.2 Package Checklist.....	7

Chapter 2 - Hardware Installation

2.1 System Board Layout	8
2.2 DIP Switch and Jumper Settings of the Processors.....	9
2.3 Jumper Settings for Clearing CMOS Data.....	14
2.4 Jumper Settings for SDRAM Clock (DIMM).....	15
2.5 Connectors.....	16

Chapter 3 - Award BIOS Setup Utility

3.1 Entering the Award BIOS Setup Utility.....	20
3.2 Setting the Date and Time.....	21
3.3 Selecting the Hard Drive and Floppy Drive Type.....	22
3.4 Selecting the Drive to be Searched First for an Operating System.....	23
3.5 Selecting the Method of Powering-off the System.....	24
3.6 Using the System Health Monitor Function.....	25
3.7 Loading Fail-Safe Settings/Optimal Settings.....	28
3.8 Setting the Supervisor/User Password.....	28

Chapter 4 - Supported Softwares

4.1 Drivers and utility.....	30
------------------------------	----

Appendix A - System Error Messages

A.1 POST Beep.....	31
A.2 Error Messages.....	31



Note:

The user's manual in the provided CD contains detailed information about the system board. If, in some cases, some information doesn't match those shown in this manual, this manual should always be regarded as the most updated version. To view the user's manual, insert the CD into a CD-ROM drive. The autorun screen (Main Board Utility CD) will appear. Click "User's Manual".

Chapter 1 - Introduction / Introduction / Einleitung

1.1 Features and Specifications

Caractéristiques et Spécifications

Leistungsmerkmale und Technische Daten

1.1.1 Features / Caractéristiques / Leistungsmerkmale

Chipset

- VIA® Apollo MVP3 AGP system chipset

Processor

- Intel Pentium® 90/100/120/133/150/166/200MHz and Intel Pentium® processor with MMX™ technology-166/200/233MHz
- Cyrix® 6x86L PR150+/PR166+/PR200+, 6x86MX-PR166/PR200/PR233/PR266 and M II-300/333/350/400
- IBM® 6x86MX-PR200/PR233/PR266/PR300/PR333
- AMD® K5 PR90/PR100/PR120/PR133/PR166, K6-166/200/233/266/300 and K6-2/250/266/300/333/350/380/400
- IDT® C6-180/200/225/240 and WINCHIP2-200/225/240/266/300

System Memory

The system board supports 8MB to 256MB of memory. It is equipped with two DIMM sockets and two SIMM sockets. The 168-pin DIMM sockets use x64 SDRAM (PC-100 SDRAM for 100MHz external system bus clock processors), 3.3V. The 72-pin SIMM sockets use x32 EDO or FPM DRAM, 5V.

DIMMs	Memory Size
1MBx64	8MB
2MBx64	16MB
4MBx64	32MB
8MBx64	64MB
16MBx64	128MB

SIMMs	Memory Size
512KBx32	4MB
1MBx32	8MB
4MBx32	32MB
8MBx32	64MB
16MBx32	128MB

Level 2 Cache Memory

512KB or 1MB pipeline burst, direct map write-back cache installed on the system board.

Expansion Slots

The system board is equipped with 1 dedicated AGP slot, 3 dedicated PCI slots, 2 dedicated 16-bit ISA slots and 1 shared PCI/ISA slot. All PCI and ISA slots are bus masters.

Desktop Management Interface (DMI)

The system board comes with a DMI 2.0 built into the BIOS. The DMI utility in the BIOS automatically records various information about your system configuration and stores this information in the DMI pool, which is a part of the system board's Plug and Play BIOS. DMI, along with the appropriately networked software, is designed to make inventory, maintenance and troubleshooting of computer systems easier.

Connectors

- 2 connectors for external USB ports
- 1 connector for IrDA interface
- 2 serial ports
- 1 parallel port
- 2 IDE connectors
- 1 floppy connector
- 1 PS/2 mouse port
- 1 PS/2 keyboard port
- 1 20-pin ATX power supply connector

PCI Bus Master IDE Controller

- Two PCI IDE interfaces support up to four IDE devices
- Ultra DMA/33 supported (Synchronous Ultra DMA mode - data transfer rate up to a maximum of 33MB/sec.)
- PIO Mode 3 and Mode 4 Enhanced IDE (data transfer rate up to 16.6MB/sec.)
- Bus mastering reduces CPU utilization during disk transfer
- ATAPI CD-ROM, LS-120 and ZIP supported

IrDA Interface

The system board is equipped with an IrDA connector for wireless connectivity between your computer and peripheral devices. It supports peripheral devices that meet the ASKIR or HPSIR standard.

USB Ports

The system board is equipped with two connectors for external USB ports. USB allows data exchange between your computer and a wide range of simultaneously accessible external Plug and Play peripherals.

BIOS

- Award BIOS, Windows® 95 Plug and Play compatible
- Flash EPROM for easy BIOS upgrades

1.1.2 Intelligence / Intelligence / Intelligente Ausstattungsteile

Monitors Processor Temperature and Overheat Alarm

The system board is able to detect the temperature of the processor. An alarm will sound in case of processor overheat.

Monitors Processor/AGP Fan Speed and Failure Alarm

The system board is able to detect the fan speed (RPM-Revolution Per Minute) and alerts you to attend to any irregularity that may damage your system.

Monitors Power Voltages and Failure Alarm

The system board is able to detect the output voltage of the power supply. An alarm will sound warning you of voltage irregularity.

Automatic Fan Control

With the system's power switched on, the processor's fan will rotate only if the temperature of the processor is over 25°C.

Dual Function Power Button

Depending on the setting in the BIOS setup, this switch will allow your system to enter the Soft-Off or Suspend mode.

External Modem Ring-on

The Modem Ring-on feature allows the system that is in the Suspend mode or Soft Power Off mode to wake-up/power-on to respond to incoming calls. This feature supports external modem only. If you are using this function, make sure to turn on the power of the modem prior to powering-off the system.

RTC Timer to Power-on the System

The RTC installed on the system board allows your system to automatically power-on on the set date and time.

ACPI

The system board is designed to meet the ACPI (Advanced Configuration and Power Interface) specification. ACPI has energy saving features that enables PCs to implement Power Management and Plug-and-Play with operating systems that support OS Direct Power Management.

Virus Protection

Most viruses today destroy data stored in hard drives. The system board is designed to protect the boot sector and partition table of your hard disk drive.

1.2 Package Checklist

Liste de Vérification de l'Emballage

Verpackungsliste

The system board package contains the following items:

- The system board
- A user's manual
- One 40-pin IDE hard disk cable
- One 34-pin floppy disk drive cable
- One CD

If any of these items are missing or damaged, please contact your dealer or sales representative for assistance.

Chapter 2 - Hardware Installation

Installation du Matériel

Installation der Hardware

2.1 System Board Layout

Position de la Carte Système

Aufbau der Hauptplatine

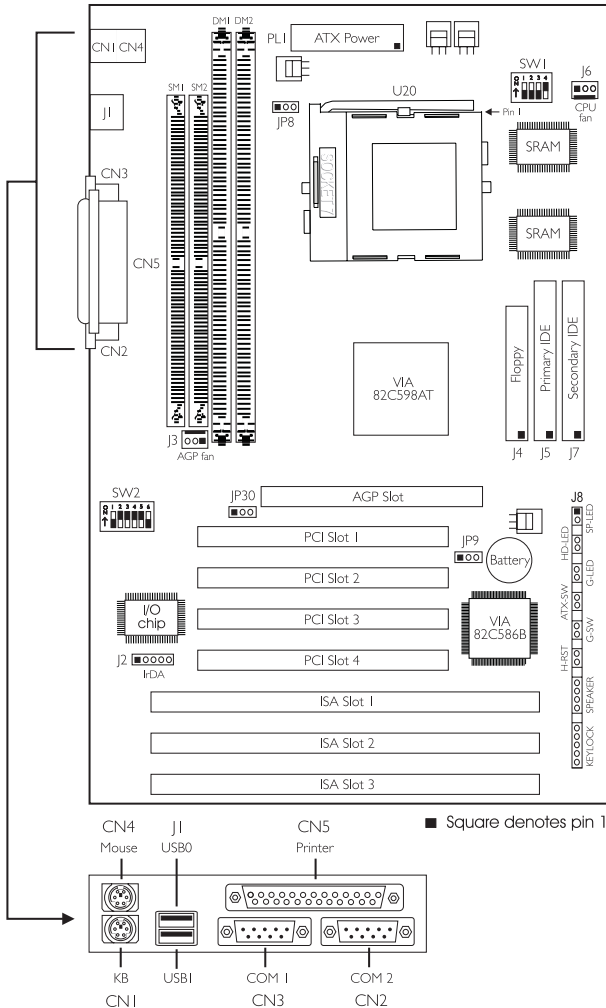

2.2 DIP Switch and Jumper Settings of the Processors Positionnement des Cavaliers sur le Processeurs DIP Schaltereinstellungen für den Prozessor

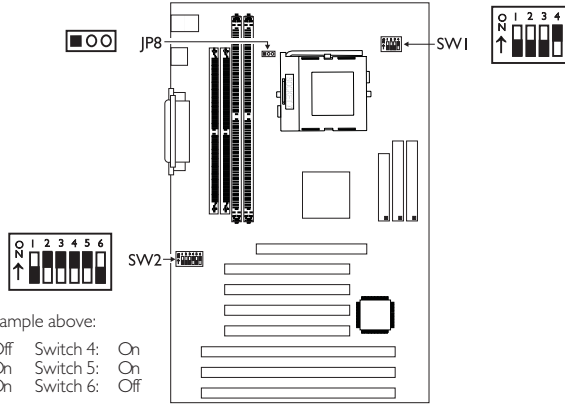





DIP Switch Settings for Intel Processors







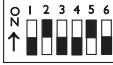











Intel Processors	SW2: 1-6	Intel Processors	SW2: 1-6
90MHz - 60MHz - 1.5x		166MHz - 66MHz - 2.5x	
100MHz - 66MHz - 1.5x		200MHz - 66MHz - 3x	
120MHz - 60MHz - 2x		MMX166MHz* - 66MHz - 2.5x	
133MHz - 66MHz - 2x		MMX200MHz - 66MHz - 3x	
150MHz - 60MHz - 2.5x		MMX233MHz - 66MHz - 3.5x	

* Default

DIP Switch Settings for IBM Processors

IBM Processors	SW2: 1-6	IBM Processors	SW2: 1-6
6x86MX-PR200 - 66MHz - 2.5x		6x86MX-PR300 - 66MHz - 3.5x	
6x86MX-PR233 - 75MHz - 2.5x		6x86MX-PR300 - 75MHz - 3x	
6x86MX-PR266 - 83MHz - 2.5x		6x86MX-PR333 - 83MHz - 3x	







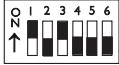



DIP Switch Settings for AMD Processors

AMD Processors	SW2: 1-6	AMD Processors	SW2: 1-6
K5 PR90 - 60MHz - 1.5x		K6-300 - 66MHz - 4.5x	
K5 PR100 - 66MHz - 1.5x		K6-2/250 - 100MHz - 2.5x	
K5 PR120 - 60MHz - 2x		K6-2/266 - 66MHz - 4x	
K5 PR133 - 66MHz - 2x		K6-2/300 - 100MHz - 3x	
K5 PR166 - 66MHz - 2.5x		K6-2/333 - 95MHz - 3.5x	
K6-166 - 66MHz - 2.5x		K6-2/333 - 66MHz - 5x	
K6-200 - 66MHz - 3x		K6-2/350 - 100MHz - 3.5x	
K6-233 - 66MHz - 3.5x		K6-2/366 - 66MHz - 5.5x	
K6-266 - 66MHz - 4x		K6-2/380 - 95MHz - 4x	





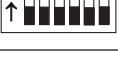

DIP Switch Settings for AMD Processors

AMD Processors	SW2: 1-6	AMD Processors	SW2: 1-6
K6-2/400 - 100MHz - 4x			

DIP Switch Settings for Cyrix Processors









Cyrix Processors	SW2: 1-6	Cyrix Processors	SW2: 1-6
6x86L PR150+ - 60MHz - 2x		6x86MX-PR266 - 83MHz - 2.5x	
6x86L PR166+ - 66MHz - 2x		M II-300 - 66MHz - 3.5x	
6x86L PR200+ - 75MHz - 2x		M II-300 - 75MHz - 3x	
6x86MX-PR166 - 60MHz - 2.5x		M II-333 - 83MHz - 3x	
6x86MX-PR200 - 66MHz - 2.5x		M II-350 - 100MHz - 3x	
6x86MX-PR233 - 75MHz - 2.5x		M II-400 - 100MHz - 3.5x	







DIP Switch Settings for IDT Processors

IDT Processors	SW2: 1-6	IDT Processors	SW2: 1-6
C6-180 - 60MHz - 3x		C6-240 - 60MHz - 4x WINCHIP2-240 - 60MHz - 4x	
C6-200 - 66MHz - 3x WINCHIP2-200 - 66MHz - 3x		WINCHIP2-266 - 83MHz - 3x	
C6-225 - 75MHz - 3x WINCHIP2-225 - 75MHz - 3x		WINCHIP2-300 - 100MHz - 3x	

External System Bus Clock / Frequency Ratio - DIP Switch Settings

If the processor you are using is not included in the previous tables, please refer to the tables below and set SW2 according to the external system bus clock and frequency ratio of your processor:

Frequency Ratio	SW2: 1-3	Frequency Ratio	SW2: 1-3
1.5x / 3.5x		4x	
2x		4.5x	
2.5x		5x	
3x		5.5x	

External System Bus Clock	SW2: 4-6	External System Bus Clock	SW2: 4-6
60MHz		83MHz	
66MHz		95MHz	
75MHz		100MHz	

































**Warning/Attention/Warnung:**

We do not guarantee that 75MHz, 83MHz, 95MHz and 100MHz external system bus clock processors will work with all types of add-in cards, memory modules or other devices.

Nous ne garantissons pas que les processeurs d'horloge de bus système externes de 75MHz, 83MHz, 95MHz et 100MHz fonctionneront avec tous les types de cartes ajoutées, les modules ou autres matériels.

Wir garantieren nicht, daß Prozessoren mit externem Systembustakt von 75, 83, 95 und 100 MHz mit allen Zusatzkarten, Modulen oder anderen Geräten arbeiten.

DIP Switch and Jumper Settings for Core Voltage

Voltage	JP8	SW1	Voltage	JP8	SW1
2.0V			2.8V		
2.1V			2.9V		
2.2V			3.0V		
2.3V			3.1V		
2.4V			3.2V		
2.5V			3.3V		
2.6V			3.4V		
2.7V			3.5V		

2.3 Jumper Settings for Clearing CMOS Data

Positionnement des Cavaliers pour Effacer les Données CMOS

Jumpereinstellungen zum Löschen der CMOS Daten

Jumper JP9 - Clear CMOS Data

To load the default values stored in the ROM BIOS, please follow the steps below.

1. Power-off the system and unplug the power cord.
2. Set JP9 pins 1 and 2 to On. Wait for a few seconds and set JP9 back to its default setting, pins 2 and 3 On.
3. Plug the power cord and power-on the system.

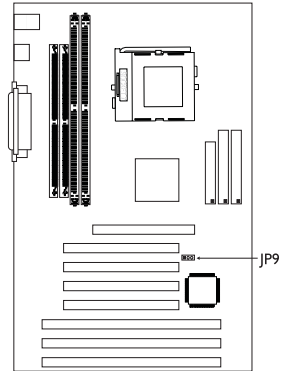

1-2 On:
Clear CMOS Data

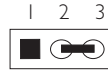

2-3 On:
Normal (default)

2.4 Jumper Settings for SDRAM Clock (DIMM)

Positionnement des Cavaliers d'Horloge SDRAM (DIMM)

Brückeneinstellungen für SDRAM-Takt (DIMM)

Jumper JP30 - SDRAM Clock

JP30 is used to set the SDRAM's clock according to the CPU clock or AGP clock. If you are using PC-100 SDRAM DIMMs, it is recommended that you set the SDRAM clock according to the CPU clock (2-3 On). This setting will provide better system performance specially when used with 75/83/95/100MHz processors. However, if you encounter compatibility problems with PC-100 SDRAM DIMMs or you are using EDO / PC-66 SDRAM DIMMs, set the SDRAM clock according to the AGP clock (1-2 On).

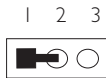
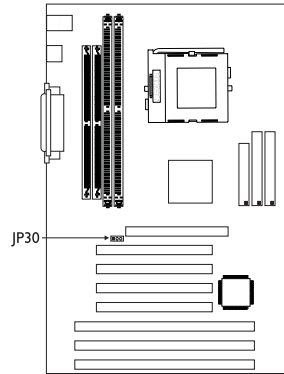

1-2 On:
SDRAM CLK = AGP CLK
(default)

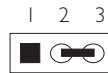

2-3 On:
SDRAM CLK = CPU CLK

CPU CLK	SDRAM CLK	AGP CLK
60MHz	60MHz	60MHz
66MHz	66MHz	66MHz
75MHz	60MHz	60MHz
83MHz	66MHz	66MHz
95MHz	66MHz	66MHz
100MHz	66MHz	66MHz

CPU CLK	SDRAM CLK	AGP CLK
60MHz	60MHz	60MHz
66MHz	66MHz	66MHz
75MHz	75MHz	60MHz
83MHz	83MHz	66MHz
95MHz	95MHz	66MHz
100MHz	100MHz	66MHz

2.5 Connectors / Connecteurs / Anschlüsse

2.5.1 Floppy Disk Drive Controller and IDE Interface Contrôleur de Lecteur de Disquette et Interface IDE Diskettenlaufwerkcontroller und IDE Interface

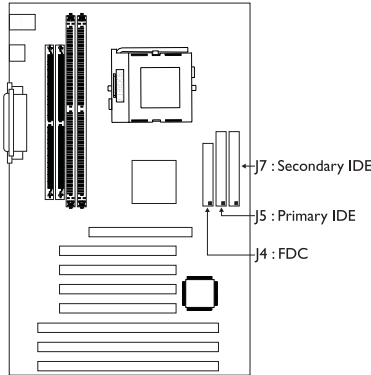

Important:

If you encountered problems while using an ATAPI CD-ROM drive that is set in Master mode, please set the CD-ROM drive to Slave mode. Some ATAPI CD-ROMs may not be recognized and cannot be used if incorrectly set in Master mode.

2.5.2 LEDs and Switches Commutateurs et LED LEDs und Schalter

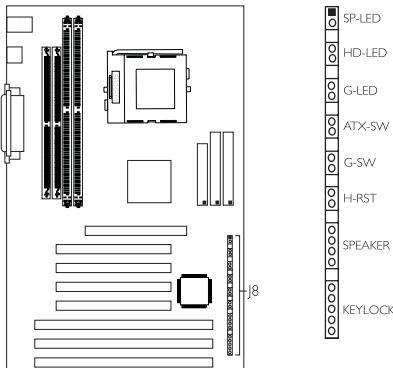

	Pin	Pin Assignment
SP-LED (ATX 5VSB Standby LED)	1	ATX Power
	2	Ground
	3	Open
HD-LED (Primary/Secondary IDE LED)	4	HDD
	5	HDD LED Power
	6	Open
G-LED (Green LED)	7	Green LED Power
	8	Green
	9	Open
ATX-SW (ATX power switch)	10	PWRBTT
	11	Ground
	12	Open
G-SW (Green switch)	13	SMI
	14	Ground
	15	Open
H-RST (Reset switch)	16	H/W Reset
	17	Ground
	18	Open
SPEAKER (Speaker connector)	19	Speaker Power
	20	Ground
	21	N. C.
	22	Speaker
	23	Open
KEYLOCK (Keylock and Power LED connector)	24	LED Power
	25	N. C.
	26	Ground
	27	Keylock
	28	Ground
		Use pins 24 to 26 for the Power LED.



Important:

ATX-SW (ATX Power Switch) - Depending on the setting in the BIOS setup, this switch is a "dual function power button" that will allow your system to enter the Soft-Off or Suspend mode. Refer to section 3.5 (chapter 3) for more information.

2.5.3 IrDA Connector Connecteur IrDA IrDA Anschlüsse

Pin	Function
1	IRTX
2	GND
3	IRRX
4	IRR3
5	VCC

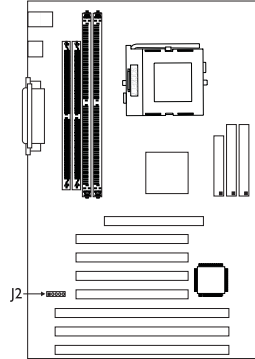

2.5.4 CPU Fan Connector Connecteur du Ventilateur de CPU CPU Kühlung Anschluß

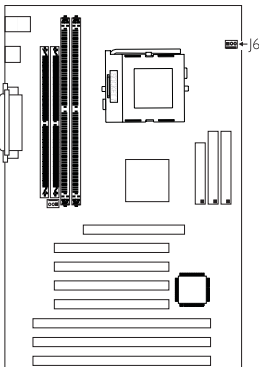

Pin	Function
1	GND
2	+12V
3	Sense

2.5.5 AGP Fan Connector Connecteur de Ventilateur AGP Anschluß AGP Kühlung

Pin	Function
1	GND
2	+12V
3	Sense

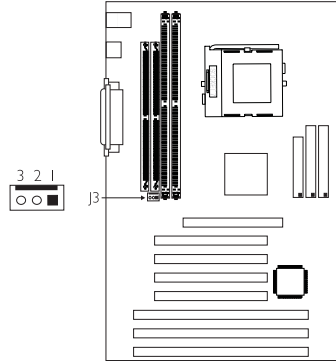

2.5.6 Power Connector Connecteur d'Alimentation Netzanschluß

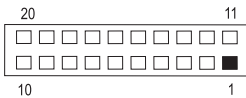
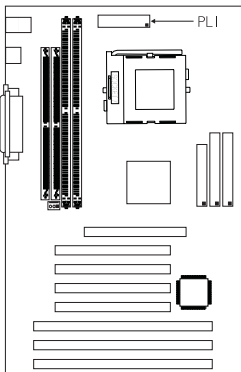

Pin	Function	Pin	Function
1	3.3V/14A	11	3.3V/14A
2	3.3V/14A	12	-12V
3	GND	13	GND
4	+5V	14	PS-ON
5	GND	15	GND
6	+5V	16	GND
7	GND	17	GND
8	PW-OK	18	-5V
9	5VSB	19	+5V
10	+12V	20	+5V

Chapter 3 - Award BIOS Setup Utility

Utilitaire de Configuration du Award BIOS

AWARD BIOS Konfigurationsprogramm

3.1 Entering the Award BIOS Setup Utility

Entrer Dans l'Utilitaire de Configuration du Award BIOS

Aufruf des AWARD BIOS Konfigurationsprogramms

Power-on the system and press to enter the utility. The main program screen will appear.

Allumez le Système et appuyez sur pour entrer dans l'utilitaire. L'écran du programme principal apparaîtra.

Zum Aufrufen des Konfigurationsprogramms drücken Sie während des Startvorgangs die Taste . Ein Bildschirm ähnlich dem folgenden erscheint.

ROM PCI/ISA BIOS
CMOS SETUP UTILITY
AWARD SOFTWARE, INC.

STANDARD CMOS SETUP BIOS FEATURES SETUP CHIPSET FEATURES SETUP POWER MANAGEMENT SETUP PNP/PCI CONFIGURATION LOAD FAIL-SAFE SETTINGS LOAD OPTIMAL SETTINGS	INTEGRATED PERIPHERALS SUPERVISOR PASSWORD USER PASSWORD IDE HDD AUTO DETECTION SAVE & EXIT SETUP EXIT WITHOUT SAVING
Esc : Quit F10 : Save & Exit Setup	↑↓→← : Select Item (Shift) F2 : Change Color

3.2 Setting the Date and Time

Paramétrage de la Date et de l'Heure Einstellen des Datums und der Zeit

ROM PCI/ISA BIOS
STANDARD CMOS SETUP
AWARD SOFTWARE, INC.

Date (mm:dd:yy) : Fri, Jul 17 1998									
Time (hh:mm:ss) : 13: 27: 50									
HARD DISKS	TYPE	SIZE	CYLS	HEAD	PRECOMP	LANDZ	SECTOR	MODE	
Primary Master	: Auto	0	0	0	0	0	0	0	Auto
Primary Slave	: Auto	0	0	0	0	0	0	0	Auto
Secondary Master	: Auto	0	0	0	0	0	0	0	Auto
Secondary Slave	: Auto	0	0	0	0	0	0	0	Auto
Drive A : 1.44M, 3.5 in.									
Drive B : None									
Video : EGA/VGA									
Halt on : All Errors									
					Base Memory : 640K				
					Extended Memory : 64512K				
					Other Memory : 384K				
					Total Memory : 65536K				
Esc : Quit			↑↓→← : Select Item			PU/PD/+/- : Modify			
F10 : Save & Exit Setup			(Shift)F2 : Change						

1. Select "Standard CMOS Setup" in the main program screen and press <Enter>.

Sélectionnez "Standard CMOS Setup" dans l'écran du programme principal et appuyez sur <Entrée>.

"Standard CMOS Setup" in dem Hauptbildschirm auswählen, und die Eingabetaste (Enter) drücken.

2. Set the correct date and time in the "Date" and "Time" fields respectively.

Sélectionnez la date et l'heure correcte dans les champs "Date" et "Time" respectivement.

Jeweils korrekte Werte in die Eingabefelder "Date" (Datum) und "Time" (Zeit) eingeben.

3.3 Selecting the Hard Drive and Floppy Drive Type

Sélectionnez le Type de Disque Dur et de Lecteur de Disquette

Auswahl der Festplatte und des Diskettenlaufwerks

ROM PCI/ISA BIOS
STANDARD CMOS SETUP
AWARD SOFTWARE, INC.

Date (mm:dd:yy) : Fri, Jul 17 1998								
Time (hh:mm:ss) : 13: 27: 50								
HARD DISKS	TYPE	SIZE	CYLS	HEAD	PRECOMP	LANDZ	SECTOR	MODE
Primary Master	: Auto	0	0	0	0	0	0	0 Auto
Primary Slave	: Auto	0	0	0	0	0	0	0 Auto
Secondary Master	: Auto	0	0	0	0	0	0	0 Auto
Secondary Slave	: Auto	0	0	0	0	0	0	0 Auto
Drive A : 1.44M, 3.5 in.								
Drive B : None								
Video : EGA/VGA						Base Memory : 640K		
Halt on : All Errors						Extended Memory : 64512K		
						Other Memory : 384K		
						Total Memory : 65536K		
Esc : Quit			↑↓→← : Select Item			PU/PD/+/- : Modify		
F10 : Save & Exit Setup			(Shift)F2 : Change					

1. Select "Standard CMOS Setup" in the main program screen and press <Enter>.

Sélectionnez "Standard CMOS Setup" dans l'écran du programme principal et appuyez sur <Entrée>.

"Standard CMOS Setup" in dem Hauptbildschirm auswählen, und die Eingabetaste (Enter) drücken.

2. Select "Auto" for the hard disk drive(s) installed in your system. The BIOS will auto-detect the HDD & CD-ROM drive at the POST stage and show the IDE for the HDD & CD-ROM drive. If a hard disk has not been installed, select "None" and press <Enter>.

Sélectionnez "Auto" pour le(s) disque(s) dur(s) installés dans votre système. Le BIOS détectera automatiquement le Disque Dur et le Lecteur CD-ROM durant la phase POST et affichera l'IDE du Disque Dur et du Lecteur CD-ROM. Si aucun disque dur n'a été installé, sélectionnez "None" et appuyez sur <entrée>.

Im Eintrag "Hard Disk Drive(s)" (Festplatte) "Auto" auswählen. Das Programm entdeckt die Festplatte sowie das CD-ROM Laufwerk während der Initialisierung automatisch. Ist keine Festplatte installiert, aktivieren Sie den Eintrag "None". Eingabetaste (Enter) drücken.

- Set the type of floppy drive installed in the "Drive A" and "Drive B" fields. The options are None, 360K, 1.2M, 720K, 1.44M and 2.88M.

Paramétrez le type de lecteur de disquette installé dans les champs "Drive A" et "Drive B". Les options sont None, 360K, 1.2M, 720K, 1.44M et 2.88M.

Im Eintrag "Floppy Drive" (Diskettenlaufwerk) wählen Sie "Drive A" (Laufwerk A) und "Drive B" (Laufwerk B). Die Optionen sind None (Kein), 360K, 1.2M, 720K, 1.44M und 2.88M.

3.4 Selecting the Drive to be Searched First for an Operating System

Sélectionner le Lecteur qui doit être Détecté en premier par un Système d'Exploitation

Auswahl des Bootlaufwerks

ROM PCI/ISA BIOS BIOS FEATURES SETUP AWARD SOFTWARE, INC.			
Virus Warning	: Disabled	Video BIOS Shadow	: Enabled
CPU Internal Cache	: Enabled	CS000-CBFFF Shadow	: Disabled
External Cache	: Enabled	CC000-CFFFF Shadow	: Disabled
Quick Power On Self Test	: Enabled	D0000-D3FFF Shadow	: Disabled
Boot Sequence	: A, C, SCSI	D4000-D7FFF Shadow	: Disabled
Swap Floppy Drive	: Disabled	D8000-DBFFF Shadow	: Disabled
Boot Up Floppy Seek	: Disabled	DC000-DFFFF Shadow	: Disabled
Boot Up NumLock Status	: On		
Typeomatic Rate Setting	: Disabled		
Typeomatic Rate (Chars/Sec)	: 6		
Typeomatic Delay (Msec)	: 250		
Security Option	: Setup		
PCI/VGA Palette Snoop	: Disabled		
OS Select For DRAM > 64MB	: Non-OS2	ESC : Quit	↑↓←→ : Select Item
HDD S.M.A.R.T. Capability	: Disabled	F1 : Help	PU/PD/+/- : Modify
		F5 : Old Values (Shift) F2 : Color	
		F6 : Load Fail-Safe Settings	
		F7 : Load Optimal Settings	

- Select "BIOS Features Setup" in the main program screen and press <Enter>.

Sélectionnez "BIOS Features Setup" dans l'écran de programme principal et appuyez sur <Entrée>.

"BIOS Features Setup" in dem Hauptbildschirm auswählen, und die Eingabetaste (Enter) drücken.

- Select the drive to be searched first in the "Boot Sequence" field. The default is A, C, SCSI. The other options are: C, A, SCSI; C, CDROM, A; CDROM, C, A; D, A, SCSI; E, A, SCSI; F, A, SCSI; SCSI, A, C; SCSI, C, A; C only and LS/ZIP, C.

Sélectionnez le lecteur qui devra être détecté en premier dans le champs "Boot Sequence". La valeur par défaut est A, C, SCSI. Les autres options sont: C, A, SCSI; C, CDROM, A; CDROM, C, A; D, A, SCSI; E, A, SCSI; F, A, SCSI; SCSI, A, C; SCSI, C, A; C seulement et LS/ZIP, C.

Im "Boot Sequence" Feld wählen Sie die Sequenz, in welcher der Computer nach einem Betriebssystem sucht. Die Optionen sind C, A, SCSI; C, CDROM, A; CDROM, C, A; D, A, SCSI; E, A, SCSI; F, A, SCSI; SCSI, A, C; SCSI, C, A; nur C und LS/ZIP, C.

3.5 Selecting the Method of Powering-off the System Sélection de la Méthode pour Eteindre le Système Auswahl der Abschaltmethode

ROM PCI/ISA BIOS POWER MANAGEMENT SETUP AWARD SOFTWARE, INC.	
Power Management : User Define	** PM Events **
PM Control by APM : Yes	IRQ3 (COM 2) : Primary
Video Off Method : DPMS	IRQ4 (COM 1) : Primary
Video Off After : Suspend	IRQ5 (LPT 2) : Primary
Standby Mode : Disabled	IRQ6 (Floppy Disk) : Primary
Suspend Mode : Disabled	IRQ7 (LPT 1) : Primary
HDD Power Down : Disabled	IRQ8 (RTC Alarm) : Disabled
Soft-Off by PWRBTN : Instant-Off	IRQ9 (IRQ2 Redir) : Secondary
Resume on Ring : Disabled	IRQ10 (Reserved) : Secondary
Resume on Alarm : Disabled	IRQ11 (Reserved) : Secondary
	IRQ12 (PS2 Mouse) : Secondary
	IRQ13 (Coprocessor) : Primary
	IRQ14 (Hard Disk) : Primary
	IRQ15 (Reserved) : Disabled
	ESC : Quit ↑ ↓ → ← : Select Item
	F1 : Help PU/PD/+/- : Modify
	F5 : Old Values (Shift) F2 : Color
	F6 : Load Fail-Safe Settings
	F7 : Load Optimal Settings

1. Select "Power Management Setup" in the main program screen and press <Enter>.

Sélectionnez "Power Management Setup" dans l'écran de programme principal et appuyez sur <Entrée>.

"Power Management Setup" in dem Hauptbildschirm auswählen, und die Eingabetaste (Enter) drücken.

2. Select the method of powering-off the system in the "Soft-Off by PWRBTN" field. The options are Hold 4 Sec. and Instant-Off.

Sélectionnez la Méthode pour éteindre le système dans le champ "Soft-Off by PWRBTN". Les options sont Hold 4 Sec. et Instant-Off.

In dem Feld "Soft-Off by PWRBTN" können Sie die Methode bestimmen, mit welcher Ihr Rechner ausgeschaltet wird. Die Optionen sind Hold 4 Sec. (4 Sekunden warten) und Instant-Off (Direktabschaltung).

Hold 4 Sec.

If the power button is pushed and released in less than 4 seconds, the system enters the Suspend mode. Push and release it again in less than 4 seconds to restore. Pushing the power button for more than 4 seconds will power-off the system.

Si le bouton de mise sous tension est poussé puis relâché en moins de 4 secondes, le système entrera en mode suspend. Poussez le et relâchez le à nouveau en moins de 4 secondes pour restaurer la fonction. Le fait d'appuyer sur le bouton de mise sous tension pendant plus de 4 secondes éteindra le système.

Wird die Netztaete gedrückt und innerhalb von 4 Sekunden wieder losgelassen, schaltet sich das System in den Suspend-Modus. Ein erneutes Drücken mit einem Loslassen innerhalb von 4 Sekunden stellt den Normalzustand wieder her. Wird die Netztaete für die Dauer von über 4 Sekunden gedrückt gehalten, schaltet sich das System ab.

Instant-Off

Pressing and then releasing the power button at once will immediately power-off the system.

Le fait d'appuyer sur le bouton de mise sous tension en une fois éteindra le système immédiatement.

Normales Drücken der Netztaete schaltet das System augenblicklich ab.

3.6 Using the System Health Monitor Function**Utilisez de System Health Monitor****Arbeiten der System Health Monitor**

ROM PCI/ISA BIOS
CHIPSET FEATURES SETUP
AWARD SOFTWARE, INC.

DIMM 1 DRAM Timing	: Normal	AGP Master 1 WS Read	: Disabled
DIMM 2 DRAM Timing	: Normal	**** System Health Monitor ****	
DIMM 3 DRAM Timing	: Normal	Current CPU Temperature	: 27°C/80°F
SDRAM CAS Latency	: 3	Current CPU Fan Speed	: 4285 RPM
SDRAM Bank Interleave	: Disabled	Current AGP Fan Speed	: 4137 RPM
DRAM Read Pipeline	: Enabled	CPU Temperature Limit	: Ignore
Sustained 3T Write	: Enabled	CPU Fan Speed Limit	: Ignore
Cache Pipeline	: Enabled	AGP Fan Speed Limit	: Ignore
Video BIOS Cacheable	: Enabled	+3.3V Voltage	: Ignore
System BIOS Cacheable	: Enabled	+12V Voltage	: Ignore
Memory Hole at 15M-16M	: Disabled	+5V Voltage	: Ignore
AGP Aperture Size (MB)	: 64		
AGP-2X Mode	: Enabled		
CPU to PCI Write Buffer	: Enabled	ESC : Quit	↑ ↓ → ← : Select Item
PCI Dynamic Bursting	: Enabled	F1 : Help	PU/PD/+/- : Modify
PCI Master 0 WS Write	: Enabled	F5 : Old Values (Shift) F2 : Color	
PCI Delay Transaction	: Enabled	F6 : Load Fail-Safe Settings	
PCI Master Read Prefetch	: Enabled	F7 : Load Optimal Settings	
PCI#2 Access #1 Retry	: Disabled		
AGP Master 1 WS Write	: Disabled		

CPU Temperature Limit

If the temperature of the processor is over the temperature limit set in this field (70°C/158°F recommended), an alarm will sound warning you of system overheat. The sound of the alarm is continuous low to high beeps.

Si la température du processeur est supérieure à la température limite spécifiée dans ce champs (70°C/158°F recommandés), une alarme retentira pour vous avertir de la surchauffe de votre système. Le son émis par d'alarme sont des bips continus faibles ou forts.

Übersteigt die Temperatur des Prozessors die in diesen Feldern eingestellte Temperatur (70°C/158°F empfohlen), ertönt ein akustisches Signal, das eine Überhitzung des Systems anzeigt. Dieses akustische Signal ertönt in einem kontinuierlichen tiefen Ton bis zu hohen Tönen.

CPU Fan Speed Limit and AGP Fan Speed Limit

If the CPU/AGP fan speed is under the speed limit set in these fields, an alarm will sound informing you to attend to any issue that may damage your system. The sound of the alarm resembles that of the siren of an ambulance.

Si la vitesse du ventilateur de CPU/AGP est inférieure aux vitesses limite spécifiées dans ces champs, une alarme retentira pour vous avertir de faire attention à toute éventualité qui pourrait endommager votre système. Le son de l'alarme ressemble à celui de la sirène d'une ambulance.

Ist die Geschwindigkeit des CPU-/AGP-Lüfters geringer als die in diesen Feldern eingestellte Geschwindigkeit, ertönt ein akustisches Signal, das einen Umstand anzeigt, durch welchen das System beschädigt werden kann. Das akustische Signal tönt ähnlich wie die Sirene eines Krankenwagens.

+3.3V, +5V and +12V Voltages

Set these fields to "Monitor" if you want the system board to detect the output voltage of the power supply. If the output voltage is over or under +3.3V/+5V/+12V ($\pm 10\%$), an alarm will sound warning you of voltage issue. The sound of the alarm is continuous low to high beeps but shorter than the temperature alarm.

Positionnez ces champs sur "Monitor" si vous voulez que la carte système détecte le voltage de sortie de l'alimentation. Si le voltage de sortie est supérieur ou inférieur à +3.3V/+5V/+12V ($\pm 10\%$), une alarme retentira vous avertissant du problème de voltage. Le son de

l'alarme est continu allant de bips faible vers des bips plus forts mais plus courts que ceux de l'alarme de température.

Falls die Ausgangsspannung des Netzteils durch die System-Platine erkannt werden soll, müssen diese Felder auf "Monitor" eingestellt werden. Befindet sich die Ausgangsspannung oberhalb oder unterhalb +3.3V/+5V/+12V ($\pm 10\%$), ertönt ein akustisches Signal, das Sie auf eine unangemessene Spannung aufmerksam macht. Dieses akustische Signal ertönt in einem kontinuierlichen tiefen Ton bis zu hohen Tönen, ist jedoch kürzer als das akustische Temperatur-Warnsignal.

System Health Monitor Utility

The system board package comes with a System Health Monitor utility.

La carte système est fournie avec une utilitaire de System Health Monitor.

Die System-Platine wird mit einem System Health Monitor geliefert.

Genesys Logic System Health Monitor Rev.A (for VIA)

The time interval for monitoring the system: Polling Interval: 4 Seconds

CPU temperature limit: CPU Over-Heat Temperature: 80 (Celsius), CPU Hysterisis Temperature: 75 (Fahrenheit), CPU Temperature: 29

Current temperature of the CPU: CPU Temperature: 29

Output voltage limit: Voltage (V)

	High Limit:	Current Voltage:	Low Limit:
3.3V Values	3.60	3.35	3.00
12V Values	13.20	12.91	10.80
5V Values	5.50	5.08	4.50

CPU/AGP fan speed limit: Fan (RPM)

	Low Limit:	Current Speed:
CPU Fan	2000	5454
AGP Fan	2000	3287

Buttons: Update w/o Save, Update and Save, User Setting, Default Setting, Quit

When enabled, this screen will minimize and display a histogram icon after boot-up: Minimize when Startup

These items when enabled will alert you in case of detected failure:

- Alarm when
- CPU Over Heat
- 3.3V Abnormal
- 12V Abnormal
- 5V Abnormal
- CPU Fan Abnormal
- AGP Fan Abnormal

Once this utility is installed, the system will ignore the settings in the "System Health Monitor" field of the Chipset Features Setup. If you are using Windows® 95 or Windows NT® 4.0, you may select between using the utility and the Chipset Features Setup. For other operating systems, you may only use the Chipset Features Setup.

Dès que cette utilitaire est installé, le système ignore les configurations dans le champs "System Health Monitor" du Chipset Features Setup. Si vous utilisez Windows® 95 ou Windows NT® 4.0,

vous pourriez sélectionner entre cette utilitaire ou bien Chipset Features Setup. Pour d'autres systèmes d'opération, vous n'utilisez que Chipset Features Setup.

Nach dem Installieren dieses Hilfsprogramms werden die Einstellungen im "System Health Monitor"-Feld der Chipset Features Setup ignoriert. Falls Sie mit Windows® 95 oder Windows NT® 4.0 arbeiten, können Sie auswählen, ob Sie das Hilfsprogramm oder die Chipset Features Setup anwenden wollen. Bei anderen Betriebssystemen kann nur die Chipset Features Setup angewendet werden.

3.7 Loading Fail-Safe Settings/Optimal Settings

Charger les Paramètres à Sécurité Relative Optimaux

Laden der Fail - Safe Einstellungen / Optimierte Einstellungen

The "Load Fail-Safe Settings" option loads the troubleshooting default values permanently stored in the ROM chips. These settings are not optimal and turn off all high performance features. You should use these values only if you have hardware problems. The "Load Optimal Settings" option loads optimized settings from the BIOS ROM. Use the Setup default values as standard values for your system.

L'option "Charger les Paramètres à Sécurité Relative" charge les valeurs de recherche de pannes par défaut stockées de manière permanente dans les puces ROM. Ces paramètres ne sont pas optimum et désactives toutes les fonctionnalités à haute performance. Vous pouvez utiliser ces valeurs seulement si vous rencontrez des problèmes de matériel.

Mit dieser Funktionen lassen sich Standardeinstellungen in dem permanenten ROM Speicher ablegen, die in Problemfällen geladen werden. Mit dieser Einstellung läßt sich der Computer im Standardmodus starten. Sie sollten diese Werte nur dann benutzen, wenn Hardwareprobleme etc. eine Starten des Computers nicht zulassen. Mit der Auswahl "Load Optimal Settings" lassen sich die optimierten Einstellungen von dem BIOS ROM abrufen. Die optimierten Einstellungen sind der Standardwert.

3.8 Setting the Supervisor/User Password

If you want to protect your system and the setup utility from unauthorized entry, set a password in the "Supervisor Password" field. If you want a user to have access only to your system but not to setup, set a password in the "User Password" field. Use the

arrow keys to highlight the "Supervisor Password" or "User Password" field and press <Enter>. The message below will appear:

Enter Password:

Type in the password. You can enter up to eight characters only. You will then be prompted to confirm the password. Type in exactly the same password.

Make sure to set the "Security Option" field in the BIOS Features Setup to "System" or "Setup". This will depend on when you would like the system to be prompted with a password.

Définir le Mot de Passe Superviseur/Utilisateur

Si vous désirez protéger votre système et Install contre toute entrée non autorisée, paramétrez un mot de passe dans le champ "Supervisor Password". Si vous désirez protéger l'accès à Install seulement, mais pas votre système, paramétrez un mot de passe dans le champ "User Password". Utilisez les touches fléchées pour sélectionner le champ "Supervisor Password" ou "User Password" et appuyez sur <Entrée>. Le message ci-dessous apparaîtra.

Enter Password:

Entrez le mot de passe. Vous êtes limité à huit caractères. Une fois que c'est fait, vous serez invité à confirmer le mot de passe, entrez exactement le même mot de passe.

Assurez vous de positionner le champs "Security Option" dans les BIOS Features Setup sur "System" ou "Setup". Cela dépend du moment où vous désirez que le système vous demande le mot de passe.

Aktivieren eines Supervisor / Benutzer Paßwortes

Wenn Sie das "Supervisor Password" aktivieren, müssen Sie vor dem Einstieg in das Konfigurationsprogramm ein Kennwort eingeben., während das "User Password" den Zugang zu dem Computer ermöglicht. Wählen Sie den Eintrag "Supervisor Password" bzw. "Supervisor Password" und betätigen Sie die Eingabetaste (Enter). Im erscheinenden Dialogfeld.

Enter Password:

Geben Sie Ihr Kennwort mit bis zu 8 Stellen ein. Betätigen Sie die Eingabetaste und geben Sie das Kennwort als Bestätigung erneut ein.

Es ist darauf zu achten, daß das Feld "Security Option" in dem BIOS Features Setup auf "System" oder "Setup" gesetzt ist.

Chapter 4 - Supported Softwares

Logiciels Supportés

Unterstützte Software

4.1 Drivers and Utility

Pilotes et Utilitaires

Treiber und Hilfsprogramme

The system board package comes with drivers for different operating systems contained in the provided CD. It also includes the System Health Monitor utility. To install the drivers and utility, please refer to the "readme" file in the CD.

All steps or procedures to install software drivers are subject to change without notice as the softwares are occasionally updated. Please refer to the readme files for the latest information.

Appendix A - System Error Message

Messages d'Erreur du Système

Fehlernachricht des Systems

When the BIOS encounters an error that requires the user to correct something, either a beep code will sound or a message will be displayed in a box in the middle of the screen and the message, PRESS F1 TO CONTINUE, CTRL-ALT-ESC or DEL TO ENTER SETUP, will be shown in the information box at the bottom. Enter Setup to correct the error.

A.1 POST Beep / Pip de POST / Akustisches POST-Signal

There are two kinds of beep codes in the BIOS. One code indicates that a video error has occurred and the BIOS cannot initialize the video screen to display any additional information. This beep code consists of a single long beep followed by three short beeps. The other code indicates that a DRAM error has occurred. This beep code consists of a single long beep.

A.2 Error Messages / Messages d'Erreur / Fehlernachrichten

One or more of the following messages may be displayed if the BIOS detects an error during the POST. This list indicates the error messages for all Awards BIOSes:

CMOS BATTERY HAS FAILED

The CMOS battery is no longer functional. It should be replaced.



Caution:

Danger of explosion if battery incorrectly replaced. Replace only with the same or equivalent type recommended by the manufacturer. Dispose of used batteries according to the battery manufacturer's instructions.

CMOS CHECKSUM ERROR

Checksum of CMOS is incorrect. This can indicate that CMOS has become corrupt. This error may have been caused by a weak battery. Check the battery and replace if necessary.

DISPLAY SWITCH IS SET INCORRECTLY

The display switch on the motherboard can be set to either monochrome or color. This indicates the switch is set to a different

setting than indicated in Setup. Determine which setting is correct, either turn off the system and change the jumper or enter Setup and change the VIDEO selection.

FLOPPY DISK(S) fail (80)

Unable to reset floppy subsystem.

FLOPPY DISK(S) fail (40)

Floppy type mismatch.

Hard Disk(s) fail (80)

HDD reset failed.

Hard Disk(s) fail (40)

HDD controller diagnostics failed.

Hard Disk(s) fail (20)

HDD initialization error.

Hard Disk(s) fail (10)

Unable to recalibrate fixed disk.

Hard Disk(s) fail (08)

Sector Verify failed.

Keyboard is locked out - Unlock the key

The BIOS detects that the keyboard is locked. Keyboard controller is pulled low.

Keyboard error or no keyboard present

Cannot initialize the keyboard. Make sure the keyboard is attached correctly and no keys are being pressed during the boot.

Manufacturing POST loop

System will repeat POST procedure infinitely while the keyboard controller is pull low. This is also used for the M/B burn in test at the factory.

BIOS ROM checksum error - System halted

The checksum of ROM address F0000H-FFFFFH is bad.

Memory test fail

The BIOS reports memory test fail if the memory has error(s).