

PB64-BX/ZX

**Rev. A+
System Board
User's Manual**

Copyright

This publication contains information that is protected by copyright. No part of it may be reproduced in any form or by any means or used to make any transformation/adaptation without the prior written permission from the copyright holders.

This publication is provided for informational purposes only. The manufacturer makes no representations or warranties with respect to the contents or use of this manual and specifically disclaims any express or implied warranties of merchantability or fitness for any particular purpose. The user will assume the entire risk of the use or the results of the use of this document. Further, the manufacturer reserves the right to revise this publication and make changes to its contents at any time, without obligation to notify any person or entity of such revisions or changes.

All Rights Reserved. © 1999

Trademarks

Microsoft® MS-DOS®, Windows™, Windows® 95 and Windows® 98 are registered trademarks of Microsoft Corporation. Intel®, Pentium® II, Pentium® III and Celeron™ are registered trademarks of Intel Corporation. Award is a registered trademark of Award Software, Inc. Other trademarks and registered trademarks of products appearing in this manual are the properties of their respective holders.

Caution:

Danger of explosion if battery incorrectly replaced.

Replace only with the same or equivalent type recommended by the manufacturer.

Dispose of used batteries according to the battery manufacturer's instructions.

FCC and DOC Statement on Class B

This equipment has been tested and found to comply with the limits for a Class B digital device, pursuant to Part 15 of the FCC rules. These limits are designed to provide reasonable protection against harmful interference when the equipment is operated in a residential installation. This equipment generates, uses and can radiate radio frequency energy and, if not installed and used in accordance with the instruction manual, may cause harmful interference to radio communications. However, there is no guarantee that interference will not occur in a particular installation. If this equipment does cause harmful interference to radio or television reception, which can be determined by turning the equipment off and on, the user is encouraged to try to correct the interference by one or more of the following measures:

- Reorient or relocate the receiving antenna.
- Increase the separation between the equipment and the receiver.
- Connect the equipment into an outlet on a circuit different from that to which the receiver is connected.
- Consult the dealer or an experienced radio TV technician for help.

Notice:

1. The changes or modifications not expressly approved by the party responsible for compliance could void the user's authority to operate the equipment.
2. Shielded interface cables must be used in order to comply with the emission limits.

Table of Contents

Chapter 1 - Introduction

1.1 Features and Specifications.....	6
1.2 Package Checklist.....	11

Chapter 2 - Hardware Installation

2.1 System Board Layout	12
2.2 System Memory.....	14
2.3 DIP Switch Settings for Processors.....	15
2.4 Jumper Settings for the CPU's Front Side Bus.....	16
2.5 Jumper Settings for Clearing CMOS Data.....	17
2.6 Jumper Settings for Wake-On-Keyboard/Wake-On-Mouse.....	18
2.7 Connecting the Ribbon Cables and Wires of the Ports and Connectors.....	19

Chapter 3 - Award BIOS Setup Utility

3.1 The Basic Input/Output System.....	33
3.1.1 Standard CMOS Setup.....	33
3.1.2 BIOS Features Setup.....	36
3.1.3 Chipset Features Setup.....	39
3.1.4 Power Management Setup.....	43
3.1.5 PNP/PCI Configuration.....	48
3.1.6 Load Fail-Safe Settings.....	50
3.1.7 Load Optimal Settings.....	50
3.1.8 Integrated Peripherals.....	51
3.1.9 Supervisor Password.....	55
3.1.10 User Password.....	56
3.1.11 IDE HDD Auto Detection.....	56
3.1.12 Save & Exit Setup.....	57
3.1.13 Exit Without Saving.....	57

Chapter 4 - Supported Softwares

4.1 Desktop Management Interface.....	58
4.2 Hardware Doctor Utility.....	61
4.3 Patch Utility and drivers.....	63

Appendix A - System Error Messages

A.1 POST Beep.....	64
A.2 Error Messages.....	64

Appendix B - Troubleshooting

B.1 Troubleshooting Checklist.....	66
------------------------------------	----

Chapter I - Introduction

I.1 Features and Specifications

I.1.1 Features

Chipset

PB64-BX

- Intel® 440BX AGPset
- ESS Solo-I PCI AudioDrive

PB64-ZX

- Intel® 440ZX-100 AGPset
- ESS Solo-I PCI AudioDrive

Processor

The system board is equipped with a 242-pin Slot 1 processor slot for installing an Intel Pentium® II/Pentium® III processor that is packaged in an SECC/SECC 2 or an Intel Celeron™ processor (SEPP). It is also equipped with a switching voltage regulator that automatically detects 1.30V to 3.5V.

- 450/100MHz or 500/100MHz Pentium® III processor
- 233/66MHz, 266/66MHz, 300/66MHz, 333/66MHz, 350/100MHz, 400/100MHz or 450/100MHz Pentium® II processor
- 266/300/300A/333/366/400/433MHz Celeron™ processor (SEPP for Slot 1)

System Memory

- PB64-BX
 - 16MB to 384MB memory using unbuffered DIMMs
 - 32MB to 768MB memory using registered DIMMs
 - Three 168-pin DIMM sockets
 - Uses x64 or x72 PC SDRAM, 3.3V
 - : PC-66 SDRAM DIMM for 66MHz FSB processors
 - : PC-100 SDRAM DIMM for 100MHz FSB processors
 - ECC supported (uses x72 PC SDRAM DIMM)

- PB64-ZX
 - 16MB to 256MB memory using unbuffered DIMMs
 - Two 168-pin DIMM sockets
 - Uses x64 PC SDRAM, 3.3V
 - : PC-66 SDRAM DIMM for 66MHz FSB processors
 - : PC-100 SDRAM DIMM for 100MHz FSB processors

DIMMs	Memory Size
2MBx64/x72	16MB
4MBx64/x72	32MB
8MBx64/x72	64MB
16MBx64/x72	128MB
32MBx64/x72	256MB*

PB64-BX

DIMMs	Memory Size
2MBx64	16MB
4MBx64	32MB
8MBx64	64MB
16MBx64	128MB

PB64-ZX

* Supported only when PB64-BX uses registered DIMMs.

Expansion Slots

The system board is equipped with 1 dedicated AGP slot. AGP is an interface designed to support high performance 3D graphics cards. It utilizes a dedicated pipeline to access system memory for texturing, z-buffering and alpha blending; delivering up to 533MB/sec. bandwidth for 3D graphics applications. AGP in this system board will deliver faster and better graphics with your PC.

The system board is also equipped with 4 dedicated PCI slots, 2 dedicated 16-bit ISA slots. All PCI and ISA slots are bus masters except PCI 4 in the PB64-ZX which is slave only.

Onboard Audio Features

- Sound Blaster, Sound Blaster Pro and WSS compatible
- Supports PC games and applications
- Sample rates from 4KHz up to 48KHz
- Full duplex operation for simultaneous record and playback
- ESS proprietary AudioRack application

Desktop Management Interface (DMI)

The system board comes with a DMI 2.0 built into the BIOS. The DMI utility in the BIOS automatically records various information about your system configuration and stores this information in the DMI pool, which is a part of the system board's Plug and Play BIOS. DMI, along with the appropriately networked software, is designed to make inventory, maintenance and troubleshooting of computer systems easier. Refer to Chapter 4 for instructions on using the DMI utility.

ATX double deck ports

- 2 USB ports
- 2 DB-9 serial ports
- 1 DB-25 parallel port
- 1 mini-DIN-6 PS/2 keyboard port
- 1 mini-DIN-6 PS/2 mouse port
- 1 game/MIDI port
- 3 audio jacks: line-out, line-in and mic-in

Connectors

- 1 connector for IrDA interface
- 2 IDE connectors
- 1 floppy connector
- 1 20-pin ATX power supply connector
- 1 3-pin WOL (Wake-On-LAN) connector
- 3 CD audio-in connectors
- 3 fan connectors for CPU, chassis and AGP fans

PCI Bus Master IDE Controller

- Two PCI IDE interfaces support up to four IDE devices
- Ultra DMA/33 supported (Synchronous Ultra DMA mode - data transfer rate up to a maximum of 33MB/sec.)
- PIO Mode 3 and Mode 4 Enhanced IDE (data transfer rate up to 16.6MB/sec.)
- Bus mastering reduces CPU utilization during disk transfer
- Supports ATAPI CD-ROM, LS-120 and ZIP and SCSI sequential boot-up

IrDA Interface

The system board is equipped with an IrDA connector for wireless connectivity between your computer and peripheral devices. It supports peripheral devices that meet the IrDA or ASKIR standard.

USB Ports

The system board is equipped with two USB ports. USB allows data exchange between your computer and a wide range of simultaneously accessible external Plug and Play peripherals.

BIOS

- Award BIOS, Windows® 95/98 Plug and Play compatible
- Flash EPROM for easy BIOS upgrades
- Includes NCR 810 SCSI BIOS
- 2MB flash memory

1.1.2 System Health Monitor Functions

The system board is capable of monitoring the following “system health” conditions.

- Monitors processor/system temperature and processor overheat alarm
- Monitors 1.5V/3.3V/±5V/±12V/VCORE voltages and failure alarm
- Monitors processor/chassis fan speed and failure alarm
- Automatic processor/chassis fan control
- Read back capability that displays accurate temperature, voltage and fan speed

1.1.3 Intelligence

Automatic CPU/Chassis Fan Off

The CPU and chassis fans will automatically turn off once the system enters the Suspend mode.

Dual Function Power Button

Depending on the setting in the BIOS setup, this switch will allow the system to enter the Soft-Off or Suspend mode.

External Modem Ring-on

The Modem Ring-on feature allows the system that is in the Suspend mode or Soft Power Off mode to wake-up/power-on to respond to incoming calls.



Note:

This feature supports external modem only.

RTC Timer to Power-on the System

The RTC installed on the system board allows your system to automatically power-on on the set date and time.

Wake-On-LAN Ready

The Wake-On-LAN function allows the network to remotely wake up a Soft Power Down (Soft-Off) PC. Your LAN card must support the remote wakeup function.



Important:

The 5VSB power source of your power supply must support $\geq 720\text{mA}$ (minimum).

Wake-On-Keyboard/Wake-On-Mouse

This function allows you to use the keyboard or mouse to power-on the system. Refer to "Jumper Settings for Wake-On-Keyboard/Wake-On-Mouse" in Chapter 2 and "Keyboard/Mouse Power On" in the

Integrated Peripherals setup of the Award BIOS in Chapter 3 for more information.



Important:

- *The power button will not function once a keyboard password has been set in the "KB Power On Password" field of the Integrated Peripherals setup. You must type the correct password to power-on the system.*
- *The 5VSB power source of your power supply must support $\geq 720\text{mA}$ (minimum).*

ACPI

The system board is designed to meet the ACPI (Advanced Configuration and Power Interface) specification. ACPI has energy saving features that enables PCs to implement Power Management and Plug-and-Play with operating systems that support OS Direct Power Management.

Virus Protection

Most viruses today destroy data stored in hard drives. The system board is designed to protect the boot sector and partition table of your hard disk drive.

1.2 Package Checklist

The system board package contains the following items:

- The system board
- A user's manual
- One 40-pin IDE hard disk cable
- One 34-pin floppy disk drive cable
- One CD

If any of these items are missing or damaged, please contact your dealer or sales representative for assistance.

Chapter 2 - Hardware Installation

2.1 System Board Layout

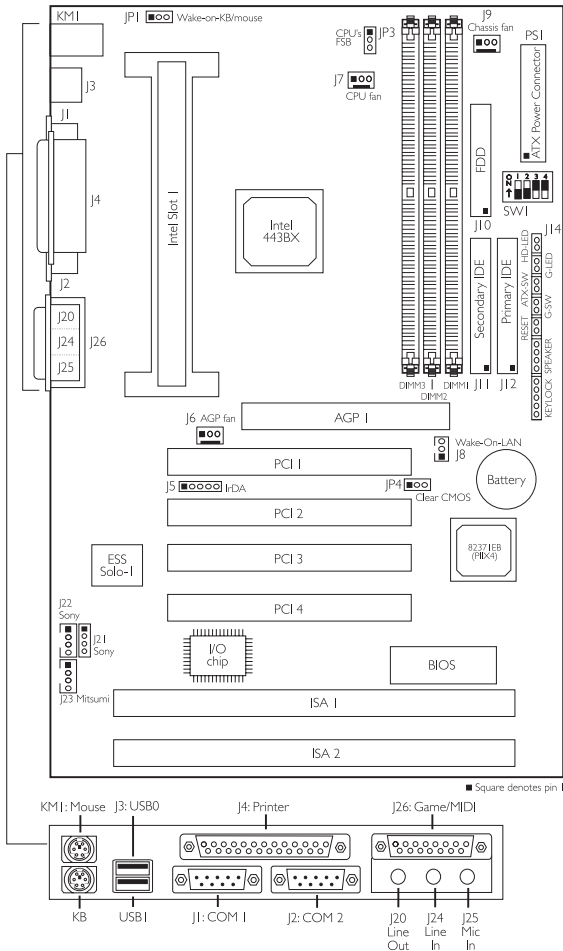

PB64-BX

**Warning:**

Electrostatic discharge (ESD) can damage your system board, processor, disk drives, add-in boards, and other components. Perform the upgrade instruction procedures described at an ESD workstation only. If such a station is not available, you can provide some ESD protection by wearing an antistatic wrist strap and attaching it to a metal part of the system chassis. If a wrist strap is unavailable, establish and maintain contact with the system chassis throughout any procedures requiring ESD protection.

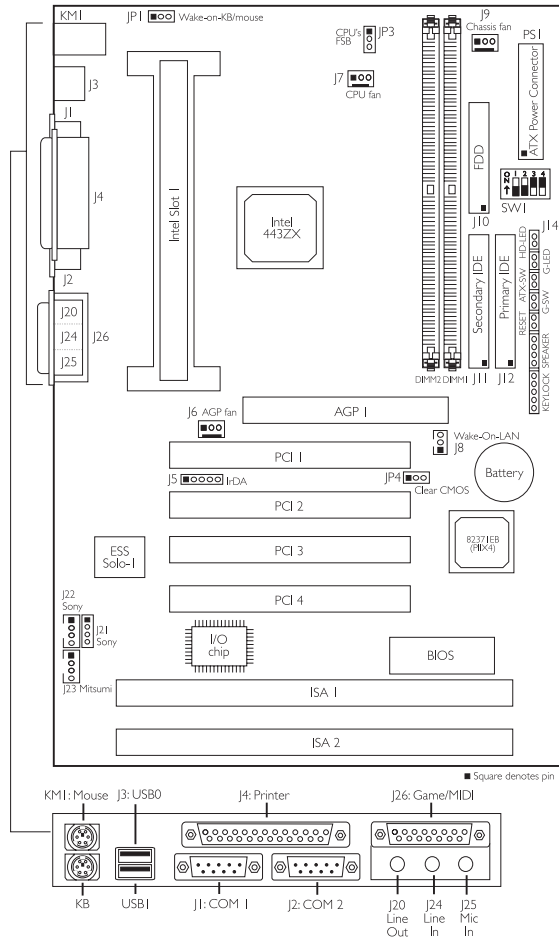
**PB64-ZX****Note:**

The illustrations on the following pages are based on the PB64-BX system board, which is the board equipped with three DIMM sockets.

2.2 System Memory

The PB64-BX system board is equipped with three 168-pin DIMM (Dual In-line Memory Module) sockets that support x64/x72 unbuffered or registered PC SDRAM DIMM, 3.3V.

The PB64-ZX system board is equipped with two 168-pin DIMM (Dual In-line Memory Module) sockets that support x64 unbuffered PC SDRAM DIMM, 3.3V.

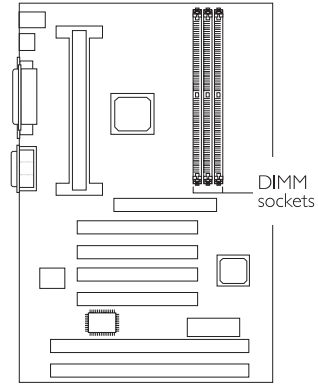

PC SDRAM (Synchronous Dynamic Random Access Memory) uses a fast memory interface technology that includes using the clock on the chip to synchronize with the CPU clock so that the timing of the memory chips and the timing of the CPU are synchronized. This saves time during transmission of data, subsequently increasing system performance.

2.2.1 Installing the DIM Module

A DIM module simply snaps into a DIMM socket on the system board. Pin 1 of the DIM module must correspond with Pin 1 of the socket.

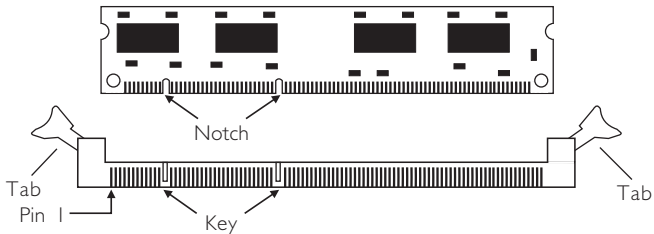

1. Pull the “tabs” which are at the ends of the socket to the side.
2. Position the DIMM above the socket with the “notches” in the module aligned with the “keys” on the socket.
3. Seat the module vertically into the socket. Make sure it is completely seated. The tabs will hold the DIMM in place.

2.3 DIP Switch Settings for Processors

The table on the next page shows the supported processors and their corresponding DIP switch settings (SW1). There are 4 switches on SW1. The black rectangle in the diagram denotes the part that is protruding, the “adjustable” switch. Make sure SW1 is set correctly before applying power, otherwise you will not be able to power-on the system.

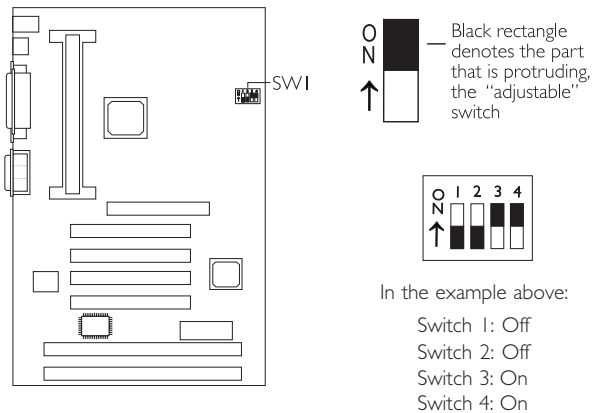

Processor		Frequency Ratio	SW1	Processor		Frequency Ratio	SW1
66MHz	100MHz			66MHz	100MHz		
233MHz	350MHz	3.5x		400MHz	Future processor	6x	
266MHz	400MHz	4x		433MHz	Future processor	6.5x	
300MHz	450MHz	4.5x		Future processor	Future processor	7x	
333MHz	500MHz	5x		Future processor	Future processor	7.5x	
366MHz	Future processor	5.5x		Future processor	Future processor	8x	



Note:

Intel Pentium® II, Intel Pentium® III processors and Intel Celeron™ processors support VID (Voltage Identification). The switching voltage regulator on the system board will automatically set the voltage regulator according to the voltage of the processor.

2.4 Jumper Settings for the CPU's Front Side Bus

Jumper JP3

CPU's Front Side Bus Select

The default setting of jumper JP3 is Auto - the system will automatically run according to the FSB of the processor. If you wish to overclock a 66MHz FSB processor to 100MHz, set pins 1, 2 and 3 to Off. If you want a 100MHz FSB processor to run at 66MHz, set pins 2 and 3 to On. Refer to the figure on the next page.

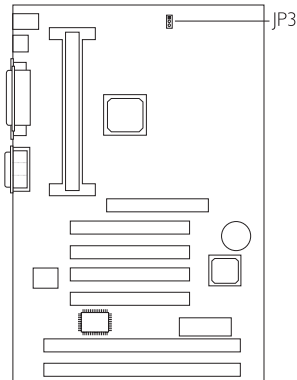

Warning:

Overclocking a 66MHz FSB processor to 100MHz will provide better system performance. However, not all 66MHz FSB processors are capable of running at 100MHz bus speed. Therefore, if you are unable to boot your system when set at 100MHz, make sure to set JP3 back to its default setting.

Jumper JP3's settings are shown below.



1-2 On: Auto
(default)



2-3 On: 66MHz

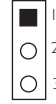

1-2-3 Off: 100MHz

2.5 Jumper Settings for Clearing CMOS Data

Jumper JP4

Clear CMOS Data

If, for some reason, the CMOS data becomes corrupted or you forgot the supervisor/user/keyboard password, the system can be reconfigured with the default values stored in the ROM BIOS. To load the default values, power off your system and **unplug the power cord**. Set JP4 pins 2 and 3 to On. Wait for a few seconds and set JP4 back to its default setting, pins 1 and 2 On. You may now plug the power cord and power-on your system.

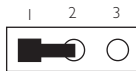
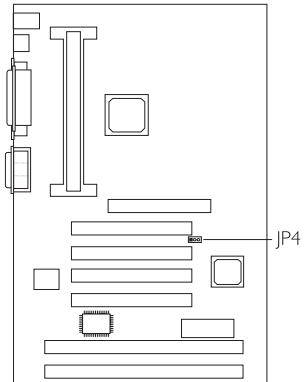

1-2 On: Normal
(default)

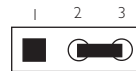

2-3 On:
Clear CMOS Data

2.6 Jumper Settings for Wake-On-Keyboard/ Wake-On-Mouse

Jumper JPI

Wake-On-Keyboard/Wake-On-Mouse

The system board supports the Wake-On-Keyboard/Wake-On-Mouse function. This function allows you to use the keyboard or mouse to power-on the system. By default, JPI is disabled. To use this function, set JPI to 2-3 On. “Keyboard/Mouse Power On” in the Integrated Peripherals setup of the Award BIOS must be set accordingly. Refer to chapter 3 for details.

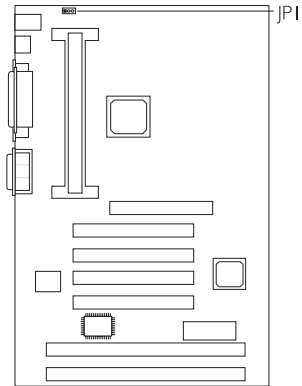

Warning:

1. If JPI was previously enabled with a password set in the “KB Power On Password” field, and now you wish to disable the Wake-On-Keyboard (password) function, make sure to set the “Keyboard/Mouse Power On” field to Disabled prior to setting JPI to disabled. You will not be able to boot up the system if you fail to do so.
2. The power button will not function once a keyboard password has been set in the “KB Power On Password” field of the Integrated Peripherals setup. You must type the correct password to power-on the system.
3. The 5VSB power source of your power supply must support $\geq 720\text{mA}$ (minimum).

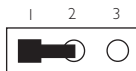

1-2 On: Disable
(default)

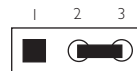

2-3 On: Enable

2.7 Connecting the Ribbon Cables and Wires of the Ports and Connectors

2.7.1 Serial Ports

The built-in serial ports are RS-232C asynchronous communication ports with 16C550A-compatible UARTs that can be used with modems, serial printers, remote display terminals, and other serial devices. You can set the serial ports' I/O address in the Integrated Peripherals setup of the Award BIOS.

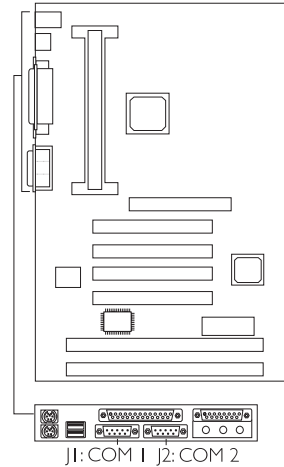

2.7.2 PS/2 Mouse and Keyboard Ports

The PS/2 mouse port uses IRQ12. If a mouse is not connected to this port, the system will reserve IRQ12 for other expansion cards.



Warning:

Make sure to turn off your computer prior to connecting or disconnecting a mouse or keyboard. Failure to do so may damage the system board.

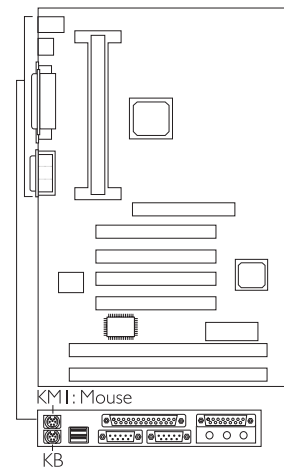

2.7.3 Parallel Ports

The system board has a standard printer port for interfacing your PC to a parallel printer. It supports SPP, ECP and EPP modes. You can set the port's mode in the Integrated Peripherals setup of the Award BIOS.

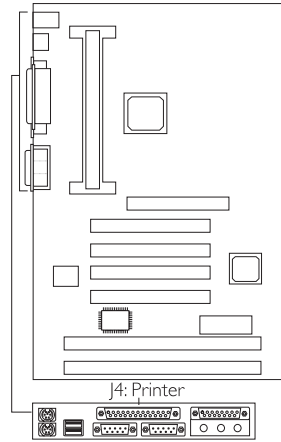

Setting	Function
SPP (Standard Parallel Port)	Allows normal speed operation but in one direction only.
ECP (Extended Capabilities Port)	Allows parallel port to operate in bidirectional mode and at a speed faster than the SPP's data transfer rate.
EPP (Enhanced Parallel Port)	Allows bidirectional parallel port operation at maximum speed.

2.7.4 Floppy Disk Controller

The system board is equipped with a shrouded floppy disk header that supports two standard floppy disk drives. To prevent improper floppy cable installation, the shrouded floppy disk header has a keying mechanism. The 34-pin connector on the floppy cable can be placed into the header only if pin 1 of the connector is aligned with pin 1 of the header. You may enable or disable this function in the Integrated Peripherals setup of the Award BIOS.

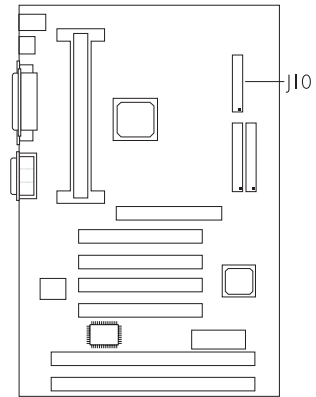

Connecting the Floppy Disk Cable

1. Install the 34-pin header connector into the shrouded floppy disk header (J10) on the system board. The colored edge of the ribbon should be aligned with pin 1 of J10.
2. Install the other 34-pin header connector(s) into the disk drive(s). Align the colored edge of the daisy chained ribbon cable with pin 1 of the drive edge connector(s). The end-most connector should be attached to the drive you want to designate as Drive A.

2.7.5 IDE Hard Disk Interface

The system board is equipped with two shrouded PCI IDE headers that will interface four Enhanced IDE (Integrated Drive Electronics) hard disk drives. To prevent improper IDE cable installation, each shrouded PCI IDE header has a keying mechanism. The 40-pin connector on the IDE cable can be placed into the header only if pin 1 of the connector is aligned with pin 1 of the header.

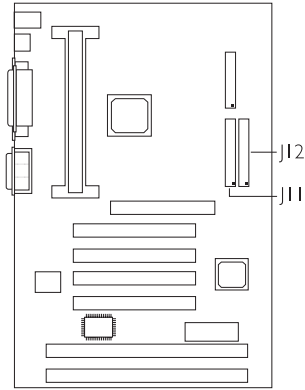

Note:

An IDE cable with a standard 40-pin connector (without the keying mechanism) can be installed in the shrouded IDE header. Be extremely careful to match the colored edge of the ribbon with pin 1 of the header.

Connecting the Hard Disk Cable

1. If you are connecting two hard drives, install the 40-pin connector of the IDE cable into the primary shrouded IDE header (connector J12). If you are adding a third or fourth IDE device, install the 40-pin connector of the other IDE cable into the secondary shrouded IDE header (connector J11).
2. Install the other 40-pin header connector(s) into the device with the colored edge of the ribbon cable aligned with pin 1 of the drive edge connector(s).



Note:

Refer to your disk drive user's manual for information about selecting proper drive switch settings.

Adding a Second IDE Hard Drive

When using two IDE drives, one must be set as the master and the other as the slave. Follow the instructions provided by the drive manufacturer for setting the jumpers and/or switches on the drives.

We recommend that you use Enhanced IDE or ATA-2, ATA-3 and Ultra DMA hard drives be from the same manufacturer. In a few cases, drives from two different manufacturers will not function properly when used together. The problem lies in the hard drives, not the system board.



Important:

If you encountered problems while using an ATAPI CD-ROM drive that is set in Master mode, please set the CD-ROM drive to Slave mode. Some ATAPI CD-ROMs may not be recognized and cannot be used if incorrectly set in Master mode.

2.7.6 USB Ports

You must have the proper drivers installed in your operating system to use these ports. Refer to your operating system's manual or documentation.

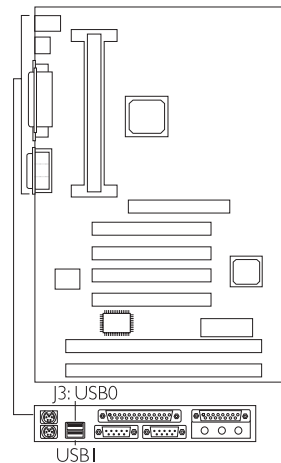

2.7.7 IrDA Connector

The system board is equipped with an IrDA connector for wireless connectivity between your computer and peripheral devices. The IRDA (Infrared Data Association) specification supports data transfers of 115K baud at a distance of 1 meter.

Connect your IrDA cable to connector J5 on the system board. Set "UART2 Mode Select" in the Integrated Peripherals setup of the Award BIOS to the type of IrDA standard supported by your device. You must have the proper drivers installed in your operating system to use this connector. Refer to your operating system's manual or documentation.

Pin	Function
1	IRTX
2	Ground
3	IRRX
4	N. C.
5	VCC

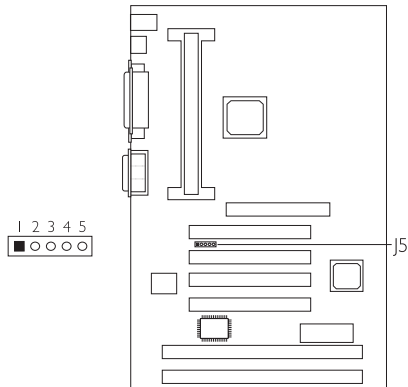

2.7.8 CPU Fan Connector

The processor must be kept cool by using a fan with heatsink. Connect the CPU fan to the 3-pin fan connector at location J7 on the system board.

Pin	Function
1	On/Off
2	+12V
3	Sense

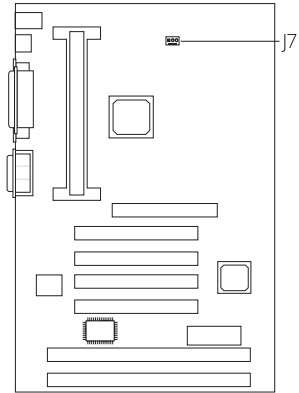

2.7.9 Chassis Fan Connector

The system board is equipped with a chassis fan connector: If you are installing a fan in the system unit, connect the fan's connector to location J9 on the system board. The fan will provide adequate airflow throughout the chassis to prevent overheating the processor.

Pin	Function
1	On/Off
2	+12V
3	Sense

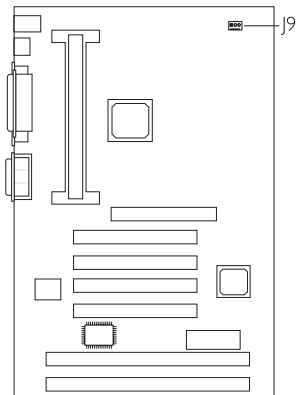

2.7.10 AGP Fan Connector

The system board is equipped with an AGP fan connector. If the system board is installed with an AGP add-in card and you wish to install a fan on the add-in card, connect the fan's connector to location J6 on the system board. Refer to the add-in card's manual for instructions on installing the fan.

Pin	Function
1	Ground
2	+12V
3	N. C.

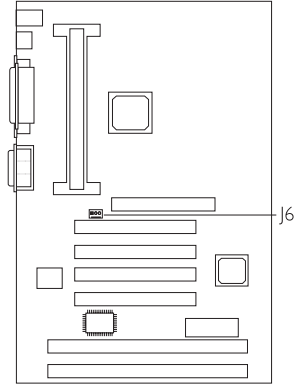

2.7.11 Game/MIDI Port

The Game/MIDI port is identical to that of a standard PC game adapter or game I/O port. Connect an analog joystick to the 15-pin D-sub connector. This port works well with any application that is compatible with the standard PC joystick.

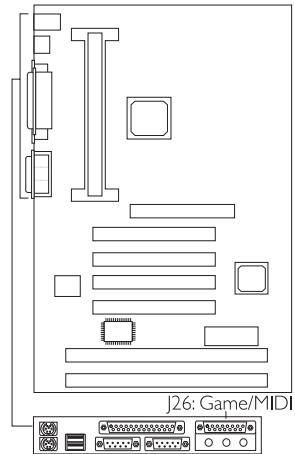

2.7.12 Audio Jacks

The system board is equipped with 3 audio jacks. A jack is a one-hole connecting interface for inserting a plug.

Line-out Jack

This jack is used to connect external speakers for audio output from the system board.

Line-in Jack

This jack can be connected to the line-out jack of any external audio devices such as Hi-fi set, CD player, AM/FM radio tuner, synthesizer, etc. Connect a stereo cable from the line-out jack of your external device to this line-in jack.

Mic-in Jack

Connect a microphone to the mic-in jack.

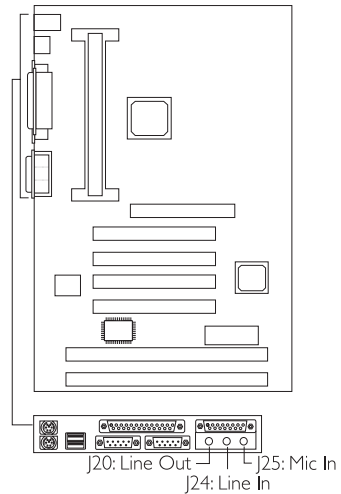

2.7.13 CD Audio-in Connector

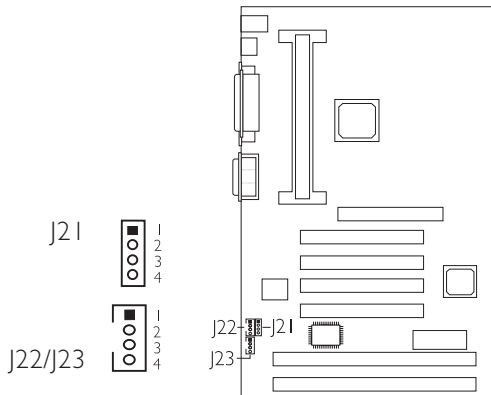

The system board is equipped with 3 CD audio-in connectors. Depending on the type of CD audio cable included in your CD-ROM package, connect one end of the cable to a CD audio-in connector on the system board and the other end to the audio line-out connector on your CD-ROM drive.

Connect the CD audio cable to J23 (Mitsumi CD-ROM) or J22 (Sony CD-ROM) if the audio cable included in your CD-ROM package should look somewhat similar to the one on the right.



Connect the CD audio cable to J21 (Sony CD-ROM) if the audio cable included in your CD-ROM package should look somewhat similar to the one on the right.



The pin assignment of the CD audio-in connectors are shown below.

Pin	J23 - Mitsumi	J22 - Sony	J21 - Sony
1	CD-L	CD-L	CD-L
2	CD-G	CD-G	CD-G
3	CD-R	CD-G	CD-G
4	CD-G	CD-R	CD-R

2.7.14 Wake-On-LAN Connector

The system board supports the Wake-On-LAN function. This function will allow the network to remotely power-on a Soft Power Down (Soft-Off) PC. However, if your system is in the Suspend mode, you can power-on the system only through an IRQ or DMA interrupt.

To use the Wake-On-LAN function, you must enable the "Resume on LAN" field in the Power Management Setup of the Award BIOS. Your LAN card package should include a cable. Connect one end of the cable to the wakeup header on the card and the other end to location J8 on the system board. The network will detect Magic Packet and assert a wakeup signal to power-up the system. Refer to the add-in card's manual for details. Note: Your LAN card must support the remote wake up function.

Pin	Function
1	+5VSB (720mA)
2	Ground
3	WOL

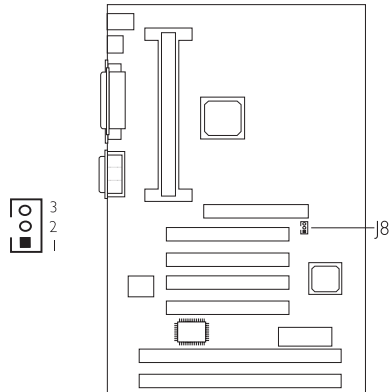

Important:

The 5VSB power source of your power supply must support $\geq 720\text{mA}$ (minimum).

2.7.15 Power Connector

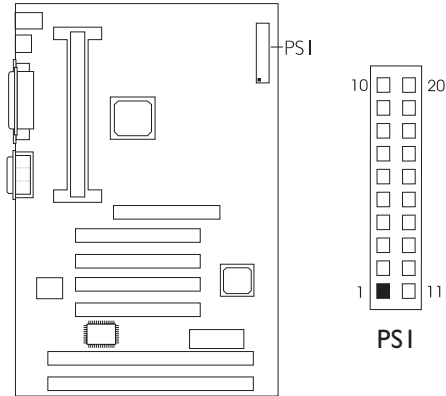

The pin assignment of the ATX power connector is shown below.

Pin	Function	Pin	Function
1	3.3V/14A	11	3.3V/14A
2	3.3V/14A	12	-12V
3	COM	13	COM
4	+5V	14	PS-ON
5	COM	15	COM
6	+5V	16	COM
7	COM	17	COM
8	PW-O.K	18	-5V
9	5VSB	19	+5V
10	+12V	20	+5V



Important:

Your power supply must meet the ATX specification - supporting 3.3V/14A (minimum), otherwise your system will not boot properly.

2.7.16 J14 (LEDs and Switches)

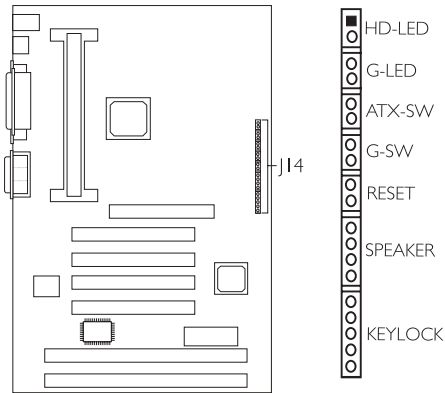

HD-LED: Primary/Secondary IDE LED

This LED will light when the hard drive is being accessed.

G-LED: Green LED

This LED will light when the system is in the Suspend mode.

ATX-SW: ATX Power Switch

Depending on the setting in the BIOS setup, this switch is a “dual function power button” that will allow your system to enter the Soft-Off or Suspend mode. Refer to “Soft-Off By PWR-BTTN” in the Power Management Setup (Chapter 3).

G-SW: Green Switch

This switch will allow your system to enter the Suspend mode.

RESET: Reset Switch

This switch allows you to reboot without having to power off the system thus prolonging the life of the power supply or system.

SPEAKER: Speaker Connector

This connects to the speaker installed in the system chassis.

KEYLOCK: Power/Standby LED and Keylock Connector

Use pins 21-23 to connect to the Power/Standby LED. This LED will light when the system's power is on and blinks when the system enters the Suspend mode.

Use pins 24 to 25 to connect to the keyboard lock (located on the front panel of the system chassis) for locking the keyboard.

	Pin	Pin Assignment
HD-LED (Primary/Secondary IDE LED)	1	HDD LED Power
	2	HDD
	3	N. C.
G-LED (Green LED)	4	Green LED Power
	5	Green
	6	N. C.
ATX-SW (ATX power switch)	7	PWRBT
	8	Ground
	9	N. C.
G-SW (Green switch)	10	SMI
	11	Ground
	12	N. C.
RESET (Reset switch)	13	H/W Reset
	14	Ground
	15	N. C.
SPEAKER (Speaker connector)	16	Speaker Data
	17	N. C.
	18	Ground
	19	Speaker Power
	20	N. C.
KEYLOCK (Keylock and Power LED connector)	21	LED Power
	22	N.C.
	23	Standby Signal
	24	Keylock
	25	Ground
		Use pins 21 to 23 for the Power/ Standby LED.

Chapter 3 - Award BIOS Setup Utility

3.1 The Basic Input/Output System

The Basic Input/Output System (BIOS) is a program that takes care of the basic level of communication between the processor and peripherals. In addition, the BIOS also contain codes for various advanced features found in this system board. This chapter explains the Setup Utility for the Award BIOS.

After you power up your system, the BIOS message appears on your screen and the memory count begins. After the memory test, the following message will appear on the screen:

Press DEL to enter setup

If the message disappears before you respond, restart your system or press the "Reset" button. You may also restart the system by pressing the <Ctrl> <Alt> and keys simultaneously.

When you press , the main program screen will appear:

ROM PCI/ISA BIOS
CMOS SETUP UTILITY
AWARD SOFTWARE, INC.

STANDARD CMOS SETUP BIOS FEATURES SETUP CHIPSET FEATURES SETUP POWER MANAGEMENT SETUP PNP/PCI CONFIGURATION LOAD FAIL-SAFE SETTINGS LOAD OPTIMAL SETTINGS	INTEGRATED PERIPHERALS SUPERVISOR PASSWORD USER PASSWORD IDE HDD AUTO DETECTION SAVE & EXIT SETUP EXIT WITHOUT SAVING
Esc : Quit F10 : Save & Exit Setup	↑↓→← : Select Item (Shift) F2 : Change Color

3.1.1 Standard CMOS Setup

Use the arrow keys to highlight "Standard CMOS Setup" and press <Enter>. A screen similar to the one on the next page will appear:

ROM PCI/ISA BIOS
STANDARD CMOS SETUP
AWARD SOFTWARE, INC.

Date (mm:dd:yy) : Fri, Mar 5 1999											
Time (hh:mm:ss) : 13: 27: 50											
HARD DISKS	TYPE	SIZE	CYLS	HEAD	PRECOMP	LANDZ	SECTOR	MODE			
Primary Master	: Auto	0	0	0	0	0	0	Auto			
Primary Slave	: Auto	0	0	0	0	0	0	Auto			
Secondary Master	: Auto	0	0	0	0	0	0	Auto			
Secondary Slave	: Auto	0	0	0	0	0	0	Auto			
Drive A : 1.44M, 3.5 in.											
Drive B : None											
Video : EGA/VGA											
Halt on : All Errors											
<table border="1"> <tr> <td>Base Memory : 640K</td> </tr> <tr> <td>Extended Memory : 64512K</td> </tr> <tr> <td>Other Memory : 384K</td> </tr> <tr> <td>Total Memory : 65536K</td> </tr> </table>								Base Memory : 640K	Extended Memory : 64512K	Other Memory : 384K	Total Memory : 65536K
Base Memory : 640K											
Extended Memory : 64512K											
Other Memory : 384K											
Total Memory : 65536K											
Esc : Quit		↑↓→← : Select Item		PU/PD/+/- : Modify							
F10 : Save & Exit Setup		(Shift)F2 : Change									

The settings on the screen are for reference only. Your version may not be identical to this one.

Date

The date format is <day>, <month>, <date>, <year>. Day displays a day, from Sunday to Saturday. Month displays the month, from January to December. Date displays the date, from 1 to 31. Year displays the year, from 1994 to 2079.

Time

The time format is <hour>, <minute>, <second>. The time is based on the 24-hour military-time clock. For example, 1 p.m. is 13:00:00. Hour displays hours from 00 to 23. Minute displays minutes from 00 to 59. Second displays seconds from 00 to 59.

Primary Master, Primary Slave, Secondary Master and Secondary Slave

These categories allow you to enter the appropriate specifications for the type of hard disk drive(s) installed in your system. Press <PgUp> or <PgDn> to select a numbered hard disk type or type the number and press <Enter>. The hard disk will not work properly if you enter improper information for this category. You can use Type "User" to define your own drive type manually. This information should be included in the documentation from your hard disk vendor. If you select Type "Auto", the BIOS will auto-detect the HDD & CD-ROM drive at the POST stage and show the IDE for the HDD & CD-ROM drive. If a hard disk has not been installed, select "None" and press <Enter>.

Drive A and Drive B

These categories identify the types of floppy disk drives installed.

<i>None</i>	No floppy drive is installed
<i>360K, 5.25 in.</i>	5-1/4 in. standard drive; 360KB capacity
<i>1.2M, 5.25 in.</i>	5-1/4 in. AT-type high-density drive; 1.2MB capacity
<i>720K, 3.5 in.</i>	3-1/2 in. double-sided drive; 720KB capacity
<i>1.44M, 3.5 in.</i>	3-1/2 in. double-sided drive; 1.44MB capacity
<i>2.88M, 3.5 in.</i>	3-1/2 in. double-sided drive; 2.88MB capacity

Video

This category selects the type of video adapter used for the primary system monitor. Although secondary monitors are supported, you do not have to select the type in Setup. The default setting is EGA/VGA (BIOS default, Setup default).

<i>EGA/VGA</i>	Enhanced Graphics Adapter/Video Graphics Array. For EGA, VGA, SVGA and PGA monitor adapters.
<i>CGA 40</i>	Color Graphics Adapter. Power up in 40-column mode.
<i>CGA 80</i>	Color Graphics Adapter. Power up in 80-column mode.
<i>Mono</i>	Monochrome adapter. Includes high resolution monochrome adapters.

Halt On

This category determines whether the system will stop if an error is detected during power up. The default setting is All Errors (BIOS default, Setup default).

<i>No Errors</i>	The system boot will not stop for any errors detected.
<i>All Errors</i>	The system boot will stop whenever the BIOS detects a non-fatal error.
<i>All, But Keyboard</i>	The system boot will not stop for a keyboard error; it will stop for all other errors.
<i>All, But Diskette</i>	The system boot will not stop for a disk error; it will stop for all other errors.
<i>All, But Disk/Key</i>	The system boot will not stop for a disk or keyboard error; it will stop for all other errors.

3.1.2 BIOS Features Setup

The BIOS Features Setup allows you to configure your system for basic operation. Some entries are defaults required by the system board, while others, if enabled, will improve the performance of your system or let you set some features according to your preference.

ROM PCI/ISA BIOS BIOS FEATURES SETUP AWARD SOFTWARE, INC.	
Virus Warning	: Disabled
CPU L1 Cache	: Enabled
CPU L2 Cache	: Enabled
CPU L2 Cache ECC Checking	: Enabled
Quick Power On Self Test	: Enabled
Boot Sequence	: A, C, SCSI
Swap Floppy Drive	: Disabled
Boot Up Floppy Seek	: Disabled
Boot Up NumLock Status	: On
Typeomatic Rate Setting	: Disabled
Typeomatic Rate (Chars/Sec)	: 6
Typeomatic Delay (Msec)	: 250
Security Option	: Setup
PCI/VGA Palette Snoop	: Disabled
OS Select For DRAM > 64MB	: Non-OS2
HDD S.M.A.R.T. Capability	: Disabled
Processor Serial Number	: Disabled
ESC	: Quit
F1	: Help
F5	: Old Values (Shift)
F6	: Load Fail-Safe Settings
F7	: Load Optimal Settings
↑↓←→	: Select Item
PU/PD/+/-	: Modify
F2	: Color

The settings on the screen are for reference only. Your version may not be identical to this one.

Virus Warning

This category protects the boot sector and partition table of your hard disk drive. When this item is enabled, the Award BIOS will monitor the boot sector and partition table of the hard disk drive. If an attempt is made to write to the boot sector or partition table of the hard disk drive, the BIOS will halt the system and an error message will appear.

After seeing the error message, if necessary, you will be able to run an anti-virus program to locate and remove the problem before any damage is done.

Many disk diagnostic programs which attempt to access the boot sector table will cause the warning message to appear. If you are running such a program, we recommend that you first disable this category. Also, disable this category if you are installing or running certain operating systems like Windows® 95 or the operating system may not install nor work.

CPU L1 Cache and CPU L2 Cache

These categories speed up the memory access. The default value is enabled. Enable the External Cache for better performance.

CPU L2 Cache ECC Checking

Intel Pentium® II, Pentium® III and Celeron™ processors come with built-in Level 2 cache. By default, ECC is enabled to check the Level 2 cache. If you are not using this function, set this field to Disabled.

Quick Power On Self Test

This category speeds up Power On Self Test (POST) after you power on your system. When Enabled, the BIOS will shorten or skip some check items during POST.

Boot Sequence

This category determines which drive to search first for the disk operating system. The default is A, C, SCSI. The options are:

A, C, SCSI;	C, A, SCSI;	C, CDROM, A;	CDROM, C, A;
D, A, SCSI;	E, A, SCSI;	F, A, SCSI;	SCSI, A, C;
SCSI, C, A;	C only;	LSI/ZIP, C.	

Swap Floppy Drive

When this option is enabled and the system is booting from the floppy drive, the system will boot from drive B instead of drive A. When this option is disabled and the system is booting from the floppy drive, the system will boot from drive A. You must have two floppy drives to use this function.

Boot Up Floppy Seek

When enabled, the BIOS will check whether the floppy disk drive installed is 40 or 80 tracks. Note that the BIOS cannot distinguish between 720K, 1.2M, 1.44M and 2.88M drive types as they are all 80 tracks. When disabled, the BIOS will not search for the type of floppy disk drive by track number. Note that there will not be any warning message if the drive installed is 360KB.

Boot Up NumLock Status

This allows you to determine the default state of the numeric keypad. By default, the system boots up with NumLock on wherein the function of the numeric keypad is the number keys. When set to Off, the function of the numeric keypad is the arrow keys.

Typematic Rate Setting

When disabled, continually holding down a key on your keyboard will cause the BIOS to report that the key is down. When the typematic rate is enabled, the BIOS will not only report that the key is down, but will first wait for a moment, and, if the key is still down, it will begin to report that the key has been depressed repeatedly. For example, you would use such a feature to accelerate cursor movements with the arrow keys.

Typematic Rate (Chars/Sec)

This selection allows you to select the rate at which the keys are accelerated.

Typematic Delay (Msec)

This selection allows you to select the delay between when the key was first depressed and when the acceleration begins.

Security Option

- System* The system will not boot and access to Setup will be denied unless the correct password is entered at the prompt.
- Setup* The system will boot, but access to Setup will be denied unless the correct password is entered at the prompt.

PCI/VGA Palette Snoop

It determines whether the MPEG ISA/VESA VGA Cards can work with PCI/VGA or not. The default value is Disabled.

- Enabled* PCI/VGA working with MPEG ISA/VESA VGA cards.
- Disabled* PCI/VGA not working with MPEG ISA/VESA VGA cards.

OS Select for DRAM > 64MB

This item allows you to access the memory that is over 64MB in OS/2. The options are: Non-OS/2 and OS/2.

HDD S.M.A.R.T. Capability

The system board supports SMART (Self-Monitoring, Analysis and Reporting Technology) hard drives. SMART is a reliability prediction technology for ATA/IDE and SCSI drives. The drive will provide sufficient notice to the system or user to backup data prior to the drive's failure. The default is Disabled. If you are using hard drives that support S.M.A.R.T., set this field to Enabled. SMART is supported in ATA-3 or later hard drives.

Processor Serial Number

This field will appear only when you are using a Pentium® III processor. Each Pentium® III processor comes with an individual "processor serial number" which by default is activated. Therefore, when connected to the Internet, Pentium® III processor transmits the serial number online making it possible to track your online activity. The field provides the option of disabling this function.

3.1.3 Chipset Features Setup

ROM PCI/ISA BIOS CHIPSET FEATURES SETUP AWARD SOFTWARE, INC.

SDRAM RAS-to-CAS Delay	: 3	**** System Health Monitor ****
SDRAM RAS Precharge Time	: 3	Current System Temp. : 28°C/82°F
SDRAM CAS Latency Time	: 3	Current CPU Temperature : 42°C/107°F
SDRAM Precharge Control	: Disabled	Current Chassis FAN Speed : 0 RPM
DRAM Data Integrity Mode	: Non-ECC	Current CPU FAN Speed : 4326RPM
System BIOS Cacheable	: Disabled	CPU(V) : 2.00 V
Video BIOS Cacheable	: Disabled	+1.5 V : 1.51 V
Video RAM Cacheable	: Disabled	+3.3 V : 3.40 V
8 Bit I/O Recovery Time	: 1	+5 V : 5.08 V
16 Bit I/O Recovery Time	: 1	+12 V : 12.34 V
Memory Hole At 15M-16M	: Disabled	-12 V : -11.76 V
PCI 2.1 Compliance	: Disabled	-5 V : -5.09 V
AGP Aperture Size (MB)	: 64	
CPU/PCI Clock (MHz)	: Default	
Spread Spectrum	: Disabled	
		ESC : Quit ↑ ↓ → ← : Select Item
		F1 : Help PU/PD +/- : Modify
		F5 : Old Values (Shift) F2 : Color
		F6 : Load Fail-Safe Settings
		F7 : Load Optimal Settings

The settings on the screen are for reference only. Your version may not be identical to this one.

This section gives you functions to configure the system based on the specific features of the chipset. The chipset manages bus speeds and access to system memory resources. It also coordinates communications between the conventional ISA bus and the PCI bus. **These items should not be altered unless necessary.** The default settings have been chosen because they provide the best operating conditions for your system. The only time you might consider making any changes would be if you discovered some incompatibility or that data was being lost while using your system.

SDRAM RAS-to-CAS Delay

This field allows you to insert a timing delay between the CAS and RAS strobe signals, used when DRAM is written to, read from, or refreshed. This field applies only when synchronous DRAM is installed in the system.

SDRAM RAS Precharge Time

If there is insufficient number of cycles for the RAS to accumulate its charge before DRAM refresh, the refresh may be incomplete and the DRAM may fail to retain data.

SDRAM CAS Latency Time

The default setting is 3 which is 3 clock cycles for the CAS latency.

DRAM Data Integrity Mode (PB64-BX only)

The ECC (Error Checking and Correction) function is supported only in x72 (72-bit) PC SDRAM DIMMs. If you are using x64 (64-bit) PC SDRAM DIMMs, set this field to Non-ECC.

Non-ECC Uses x64 PC SDRAM DIMM.

ECC This option allows the system to recover from memory failure. It detects single-bit and multiple-bit errors, then automatically corrects single-bit error.

System BIOS Cacheable

When this option is enabled, accesses to the system BIOS ROM addressed at F0000H-FFFFFH are cached, provided that the cache controller is enabled. The larger the range of the Cache RAM, the higher the efficiency of the system.

Video BIOS Cacheable

As with caching the system BIOS, enabling the Video BIOS cache will allow access to video BIOS addresssed at C0000H to C7FFFH to be cached, if the cache controller is also enabled. The larger the range of the Cache RAM, the faster the video performance.

Video RAM Cacheable

When enabled, it allows the video RAM to be cacheable thus providing better video performance. If your graphics card does not support this function, leave this field in its default setting - Disabled.

8 Bit I/O Recovery Time and 16 Bit I/O Recovery Time

The recovery time is the length of time, measured in SYSCLK, which the system will delay after the completion of an input/output request. This delay takes place because the CPU is operating so much faster than the input/output bus that the CPU must be delayed to allow for the completion of the I/O. This item allows you to determine the recovery time allowed for 8-bit I/O or 16-bit I/O.

Memory Hole At 15M-16M

In order to improve system performance, certain space in memory can be reserved for ISA cards. This memory must be mapped into the memory space below 16MB. When enabled, the CPU assumes the 15-16MB memory range is allocated to the hidden ISA address range instead of the actual system DRAM. When disabled, the CPU assumes the 15-16MB address range actually contains DRAM memory. If more than 16MB of system memory is installed, this option must be disabled to provide contiguous system memory.

PCI 2.1 Compliance

By default, this field is Disabled. However, if you encounter problems with your PCI card, try setting this field to Enabled. It may be that your card is PCI 2.1 compliant.

AGP Aperture Size (MB)

This field is relevant to the memory-mapped graphics data of the AGP card installed in your system. Leave this in its default setting, which is 64MB.

CPU/PCI Clock (MHz)

The options are Default, 66.8/33.4, 75/37.5, 83.3/41.65, 100.3/33.4, 103/34.33, 105/35, 110/36.67, 112/37.33, 115/38.33, 120/40, 124/31, 124/41.33, 133/33.25, 133/44.33, 140/35 and 150/37.5. When selecting the external bus clock of your processor, the PCI clock will at the same time appear next to the external bus clock selected. For example, if you selected "66.8/33.4", 66.8MHz is the external bus clock and 33.4MHz is the PCI clock. Regardless of the type of processor used, the default setting is "Default". Under this setting, the system will run according to the processor's clock frequency. If you selected an option other than "Default" and is unable to boot up the system, there are 2 methods of going back to its default setting.

Method 1: Clear the CMOS data by following the procedure in section 2.5 (chapter 2) of this manual. All fields in the BIOS Setup will automatically be set to its default settings.

Method 2: Press the <Insert> key and power button simultaneously, then release the power button first. You must keep-on pressing the <Insert> key until the power-on screen appears. This will allow the system to boot according to the FSB of the processor. Now press the key to enter the Award BIOS setup utility. Select "Chipset Features Setup" and set the "CPU/PCI Clock (MHz)" field to "Default" or an appropriate clock frequency.



Note:

When using a 66MHz FSB processor, the AGP clock and the CPU's external bus clock are similar. When using a 100MHz FSB processor, the AGP clock is 2/3 of the CPU's external bus clock.

Spread Spectrum

Leave this field in its default setting - Disabled. Do not alter this setting unless advised by an engineer or technician.

System Health Monitor

The BIOS is capable of monitoring the following system “health” conditions: processor and system temperature, fan speed of the chassis and CPU fans, voltage of the processor and output voltage of the power supply.

The temperature, fan speed and voltage of these monitored items are shown in this section of the Chipset Features Setup.

- **Current System Temperature, Current CPU Temperature, Current Chassis Fan Speed and Current CPU Fan Speed**

These fields show the internal temperature of the system, current temperature of the processor, and the current fan speed of the chassis and CPU fans in RPM (Revolutions Per Minute).

- **CPU(V)**

This field shows the voltage of the processor:

- **+1.5V, +3.3V, +5V, +12V, -12V and -5V**

These fields show the output voltage of the power supply.

3.1.4 Power Management Setup

The Power Management Setup allows you to configure your system to most effectively save energy. If you like to use the soft power down feature of Windows® 95/98, you must enable the Power Management function. Select Min. Power, Max. Power or User Defined. Either one can be used as long as it is NOT disabled.

ROM PCI/ISA BIOS
POWER MANAGEMENT SETUP
AWARD SOFTWARE, INC.

ACPI Function	: Disabled		
Power Management	: User Define		
PM Control by APM	: Yes		
Video Off Method	: DPMS		
Video Off After	: Suspend		
MODEM Use IRQ	: 3		
Standby Mode	: Disabled		
Suspend Mode	: Disabled		
HDD Power Down	: Disabled		
PCI/VGA Act-Monitor	: Disabled		
Soft-Off by PWR-BTTN	: Instant-Off		
PWR Lost Resume State	: Keep Off		
Resume on Ring	: Disabled		
Resume on LAN	: Disabled		
Resume on Alarm	: Disabled		
		ESC : Quit	↑↓→← : Select Item
		F1 : Help	PU/PD/+/- : Modify
		F5 : Old Values (Shift) F2	: Color
		F6 : Load Fail-Safe Settings	
		F7 : Load Optimal Settings	

The settings on the screen are for reference only. Your version may not be identical to this one.

ACPI Function

By default, the ACPI function is disabled. This function should be enabled only in operating systems that support ACPI.

Power Management

This category allows you to select the type (or degree) of power saving by changing the length of idle time that elapses before the Standby mode and Suspend mode are activated.

Disable No power management. Disables the Standby and Suspend modes.

Min. Power Saving Minimum power management. Standby Mode = 1 hr., and Suspend Mode = 1 hr.

Max. Power Saving Maximum power management. Standby Mode = 1 min., and Suspend Mode = 1 min.

User Defined Allows you to set each mode individually. When enabled, each option ranges from 1 min. to 1 hr.

PM Control by APM

Yes An Advanced Power Management device will be activated to enhance the power saving mode and stop the CPU's internal clock. Use this option in Windows® 95/98. (default)

No The system BIOS will ignore APM when initiating the Power Management mode.

Video Off Method

This determines the manner in which the monitor is blanked.

- V/H SYNC + Blank* This selection will cause the system to turn off the vertical and horizontal synchronization ports and write blanks to the video buffer.
- Blank Screen* This option only writes blanks to the video buffer.
- DPMS* Initializes display power management signaling. Use this option if your video board supports it.

Video Off After

- N/A* The system BIOS will never turn off the screen.
- Suspend* The screen is off when the system is in the Suspend mode.
- Standby* The screen is off when the system is in the Standby mode.

MODEM Use IRQ

This category is used to set an IRQ channel (IRQ 3, 4, 5, 7, 9, 10 or 11) for the external modem installed in your system. However, if the "Resume on Ring" or "Resume on LAN" field is disabled, the BIOS will mask the IRQ assigned for the modem. This is to prevent the modem or LAN from waking up the system when it is in the Suspend mode.

Standby Mode

This is user configurable only when the Power Management category is set to User Defined. When enabled and after the set time of system inactivity, video will be shut off while all other devices still operate at full speed.

Suspend Mode

This is user configurable only when the Power Management category is set to User Defined. When enabled and after the set time of system inactivity, the CPU and onboard peripherals will be shut off.

HDD Power Down

This is user configurable only when the Power Management category is set to User Defined. When enabled and after the set time of system inactivity, the hard disk drive will be powered down while all other devices remain active.

PCI/VGA Act-Monitor

Enabled When the system enters the Suspend mode, it will check the status of the VGA. If the VGA is active, it will not turn the screen off. If the VGA is inactive, it will turn the screen off.

Disabled When the system enters the Suspend mode, it will immediately turn the screen off without checking the status of the VGA.

Soft-Off by PWR-BTTN

This category allows you to select the method of powering off your system.

Hold 4 Sec. Regardless of whether the Power Management field is enabled or disabled, if the power button is pushed and released in less than 4 sec, the system enters the Suspend mode. The purpose of this function is to prevent the system from powering off in case you accidentally "hit" or pushed the power button. Push and release again in less than 4 sec to restore. Pushing the power button for more than 4 seconds will power off the system.

Instant-Off Pressing and then releasing the power button at once will immediately power off your system.

PWR Lost Resume State

Keep Off When power returns after an AC power failure, you must press the Power button to power-on the system.

Turn On When power returns after an AC power failure, the system will automatically power-on.

Last State When power returns after an AC power failure, the operating session where you left off before power failure occurs will resume.

Resume On Ring

With an external modem installed, the Modem Ring-on function will allow your system to power-on to respond to incoming calls. By default, the "Resume on Ring" field is Disabled. To use this function, please follow the steps below.

1. Make sure the computer system is powered off.
2. Connect the external modem to the COM 1 or COM 2 serial port.
3. Switch on the power of the external modem.
4. Power-on the computer system. After the memory test, press to enter the Award BIOS setup utility.
5. Select Power Management Setup and press <Enter>.
6. Enable the "Resume on Ring" field.
7. Press <Esc> to return to the main menu of the Award BIOS setup utility. Select "Save & Exit Setup" and press <Enter>.
8. Type <Y> and press <Enter>.

Resume On LAN

With a LAN card installed, the Wake-On-LAN function allows the network to remotely wake up a Soft Power Down (Soft-Off) PC. However, if your system is in the Suspend mode, you can wake-up the system only through an IRQ or DMA interrupt. Make sure your LAN card supports the remote wakeup function. To use this function, set this field to Enabled. Refer to the "Wake-On-LAN Connector" section in Chapter 2 of this manual for more information.

Resume On Alarm

Enabled When Enabled, you can set the date and time you would like the Soft Power Down (Soft-Off) PC to power-on. "Date (of Month)" and "Timer (hh:mm:ss)" fields will appear right below this field. If the system is being accessed by incoming calls (Resume On Ring) prior to the date and time set in these fields, the system will give priority to the incoming call.

Disabled Disables the automatic power-on function. (default)

Date (of Month)

- 0 The system will power-on everyday according to the time set in the "Timer (hh:mm:ss)" field.
- 1-31 Select a date you would like the system to power-on. The system will power-on on the set date, and time set in the "Timer (hh:mm:ss)" field.

Timer (hh:mm:ss)

This is used to set the time you would like the system to power-on. If you want the system to power-on everyday as set in the "Date (of Month)" field, the time set in this field must be later than the time of the RTC in the Standard CMOS Setup.

3.1.5 PNP/PCI Configuration

This section describes configuring the PCI bus system. It covers some very technical items and it is strongly recommended that only experienced users should make any changes to the default settings.

ROM PCI/ISA BIOS PNP/PCI CONFIGURATION AWARD SOFTWARE, INC.			
Resources Controlled By	: Auto	Assign IRQ for VGA	: Enabled
Reset Configuration Data	: Disabled	Assign IRQ for USB	: Enabled
		Onboard Sound/PCI3 IRQ	: 5
		PCI Slot 1 Use IRQ	: Auto
		PCI Slot 2 Use IRQ	: Auto
		PCI Slot 4 Use IRQ	: Auto
		ESC	: Quit
		F1	: Help
		F5	: Old Values (Shift)
		F6	: Load Fail-Safe Settings
		F7	: Load Optimal Settings
		↑ ↓ → ←	: Select Item
		PU/PD +/-	: Modify
		F2	: Color

The settings on the screen are for reference only. Your version may not be identical to this one.

Resources Controlled By

The Award Plug and Play BIOS has the capability to automatically configure all of the boot and Plug and Play compatible devices.

- Auto* The system will automatically detect the settings for you. The categories that follow will not be shown on the screen.
- Manual* This will allow you to set the IRQ/DMA (you have assigned your add-in card) to Legacy ISA or PCI/ISA PnP. For non-PnP ISA cards, select Legacy ISA. For PnP ISA or PCI cards, select PCI/ISA PnP.

Reset Configuration Data

- Enabled* The BIOS will reset the configuration data once automatically. It will then recreate a new set of configuration data.
- Disabled* The BIOS will not reset the configuration data.

Assign IRQ for VGA

When Enabled, the system automatically assigns an IRQ for the VGA card installed. Your VGA card will need an IRQ only when using the video capture function of the card. If you are not using this function and a new device requires an IRQ, you can set this function to Disabled. The IRQ (previously occupied by the VGA card) will be available for your new device.



Note:

When Disabled, a "Yellow" mark will appear in Windows® 95's or Windows® 98's Device Manager.

Assign IRQ for USB

When Enabled, the system automatically assigns an IRQ for the USB device connected to your system. However, if you are not using USB devices and an ISA slot requires an IRQ, set this function to Disabled. The IRQ previously occupied by the USB device will be available for the ISA slot.



Note:

When Disabled, a "Yellow" mark will appear in Windows® 95's or Windows® 98's Device Manager.

Onboard Sound/PCI3 Use IRQ

By default, the IRQ 5 is automatically assigned to the onboard sound and PCI Slot 3.

PCI Slot 1 Use IRQ, PCI Slot 2 Use IRQ and PCI Slot 4 Use IRQ

By default, an IRQ is automatically assigned to each PCI slot. You may also manually assign an IRQ to these slots. The options are: 3, 4, 5, 7, 9, 10, 11, 12, 14 and 15.

3.1.6 Load Fail-Safe Settings

The "Load Fail-Safe Settings" option loads the troubleshooting default values permanently stored in the ROM chips. These settings are not optimal and turn off all high performance features. You should use these values only if you have hardware problems. Highlight this option on the main menu and press <Enter>. The message below will appear:

Load Fail-Safe Settings (Y/N)? N

If you want to proceed, type <Y> and press <Enter>. The default settings will be loaded.

3.1.7 Load Optimal Settings

The "Load Optimal Settings" option loads optimized settings from the BIOS ROM. Use the Setup default values as standard values for your system. Highlight this option on the main menu and press <Enter>. The message below will appear:

Load Optimal Settings (Y/N)? N

Type <Y> and press <Enter> to load the Setup default values.

3.1.8 Integrated Peripherals

ROM PCI/ISA BIOS
INTEGRATED PERIPHERALS
AWARD SOFTWARE, INC.

IDE HDD Block Mode	: Enabled	KBC Input Clock	: 8MHz
IDE Primary Master PIO	: Auto	Onboard FDC Controller	: Enabled
IDE Primary Slave PIO	: Auto	Onboard Serial Port 1	: 3F8/IRQ4
IDE Secondary Master PIO	: Auto	Onboard Serial Port 2	: 2F8/IRQ3
IDE Secondary Slave PIO	: Auto	UART2 Mode Select	: Normal
IDE Primary Master UDMA	: Auto		
IDE Primary Slave UDMA	: Auto	Onboard Parallel Port	: 378/IRQ7
IDE Secondary Master UDMA	: Auto	Parallel Port Mode	: ECP+EPP
IDE Secondary Slave UDMA	: Auto	ECP Mode Use DMA	: 3
On-chip Primary PCI IDE	: Enabled	EPP Mode Select	: EPP1.7
On-chip Secondary PCI IDE	: Enabled	Keyboard/Mouse Power On	: Disabled
USB Keyboard Support	: Disabled		
Init Display First	: AGP		
		ESC : Quit	↑ ↓ → ← : Select Item
		F1 : Help	PU/PD/+/- : Modify
		F5 : Old Values (Shift)	F2 : Color
		F6 : Load Fail-Safe Settings	
		F7 : Load Optimal Settings	

The settings on the screen are for reference only. Your version may not be identical to this one.

IDE HDD Block Mode

Enabled The IDE HDD uses the block mode. The system BIOS will check the hard disk drive for the maximum block size the system can transfer. The block size will depend on the type of hard disk drive.

Disabled The IDE HDD uses the standard mode.

IDE Primary Master/Slave PIO and IDE Secondary Master/Slave PIO

PIO means Programmed Input/Output. Rather than have the BIOS issue a series of commands to effect a transfer to or from the disk drive, PIO allows the BIOS to tell the controller what it wants and then let the controller and the CPU perform the complete task by themselves. Your system supports five modes, 0 (default) to 4, which primarily differ in timing. When Auto is selected, the BIOS will select the best available mode after checking your drive.

Auto The BIOS will automatically set the system according to your hard disk drive's timing.

0-4 You can select a mode that matches your hard disk drive's timing. Caution: Do not use the wrong setting or you will have drive errors.

IDE Primary Master/Slave UDMA and IDE Secondary Master/Slave UDMA

These categories allow you to set the Ultra DMA in use. When Auto is selected, the BIOS will select the best available option after checking your hard drive or CD-ROM.

- Auto* The BIOS will automatically detect the settings for you.
- Disabled* The BIOS will not detect these categories.

On-Chip Primary PCI IDE and On-Chip Secondary PCI IDE

These categories allow you to enable or disable the primary and secondary IDE controller. The default is Enabled. Select Disabled if you want to add a different hard drive controller.

USB Keyboard Support

By default, USB Keyboard Support is Disabled. However, if you are using a USB keyboard under DOS, make sure to enable this function.

Init Display First

This field is used to select whether to initialize AGP or PCI first when the system boots.

- AGP* When the system boots, it will first initialize AGP.
- PCI Slot* When the system boots, it will first initialize PCI.

KBC Input Clock

This is used to select the input clock of your keyboard. The options are: 8MHz and 12MHz. The default is 8MHz.

Onboard FDC Controller

- Enabled* Enables the onboard floppy disk controller.
- Disabled* Disables the onboard floppy disk controller.

Onboard Serial Port 1 and Onboard Serial Port 2

Auto The system will automatically select an I/O address for the onboard serial port 1 and serial port 2.

3F8/IRQ4, 2F8/IRQ3, 3E8/IRQ4, 2E8/IRQ3 Allows you to manually select an I/O address for the onboard serial port 1 and serial port 2.

Disabled Disables the onboard serial port 1 and/or serial port 2.

UART2 Mode Select

The system board supports IrDA function for wireless connectivity between your computer and peripheral devices. You may not use IrDA (J5) and the COM 2 serial port (J2) at the same time. If you are using the COM 2 serial port, make sure "UART2 Mode Select" is set to Normal.

To use the IrDA function, follow the steps below.

1. Connect your IrDA cable to connector J5 on the system board.
2. Set "UART2 Mode Select" to the type of IrDA standard supported by your IrDA peripheral/device (IrDA 1.0 or ASKIR). For better transmission of data, your IrDA peripheral device must be within a 30° angle and within a distance of 1 meter.
3. The following will appear right after "UART2 Mode Select".

IR Transmission Delay

If this option is Enabled, transmission of data will be slower. This is recommended when you encounter transmission problem with your device. The options are: Enabled and Disabled.

Onboard Parallel Port

378H/IRQ7, 3BCH/IRQ7, 278H/IRQ5 Selects the I/O address and IRQ for the onboard parallel port.

Disabled Disables the onboard parallel port.

Parallel Port Mode, ECP Mode Use DMA and EPP Mode Select

These fields will appear only if you selected an I/O address and IRQ in the Onboard Parallel Port field. These apply to a standard specification and will depend on the type and speed of your device. Refer to your peripheral's manual for the best option.

The parallel modes are SPP, EPP, ECP and ECP+EPP. The default is ECP+EPP. Both "ECP Mode Use DMA" and "EPP Mode Select" will appear on the screen. If you selected EPP, "EPP Mode Select" will appear. This field applies to standard specification. The options are EPP1.9 and EPP1.7. Default setting: EPP1.7. If you selected ECP, "ECP Mode Use DMA" will appear. This is used to select a DMA channel for the parallel port. The options are 1 and 3. Default setting: 3.

Keyboard/Mouse Power On

This field allows you to use the keyboard or mouse to power-on the system. To use this function, make sure JPI is set to 2-3 On - the Wake-On-Keyboard/Mouse function enabled. Refer to "Jumper Settings for Wake-On-Keyboard/Wake-On-Mouse" in Chapter 2 of this manual for more information.

Disabled

Default setting:



Warning:

If JPI was previously enabled with a password set in the "KB Power On Password" field, and now you wish to disable the Wake-On-Keyboard (password) function, make sure to set this field to disabled prior to setting JPI to disabled (1-2 On). You will not be able to boot up the system if you fail to do so.

Password

When this option is selected, the "KB Power On Password" field will appear. Move the cursor to this field and press <Enter>. Enter your password. You can enter up to 5 characters. Type in exactly the same password to confirm, then press <Enter>.



Important:

The power button will not function once a keyboard password has been set in the "KB Power On Password" field. You must type the correct password to power-on the system.

- Hot Key* When this option is selected, the “KB Power On Hot Key” field will appear. Move the cursor to this field to select a function key you would like to use to power-on the system. The options are from Ctrl-F1 to Ctrl-F12.
- Mouse Left* When this option is selected, double-click the left button of the mouse to power-on the system.
- Mouse Right* When this option is selected, double-click the right button of the mouse to power-on the system.
- Any Key* Press any key to power-on the system.
- Keyboard 98* When this option is selected, press the “wake up” key of the Windows® 98 compatible keyboard to power-on the system.

3.1.9 Supervisor Password

If you want to protect your system and setup from unauthorized entry, set a supervisor’s password with the “System” option selected in the BIOS Features Setup. If you want to protect access to setup only, but not your system, set a supervisor’s password with the “Setup” option selected in the BIOS Features Setup. You will not be prompted for a password when you cold boot the system.

Use the arrow keys to highlight the “Supervisor Password” option and press <Enter>. The message below will appear:

Enter Password:

Type in the password. You are limited to eight characters. When done, the message below will appear:

Confirm Password:

You are asked to verify the password. Type in exactly the same password. If you type in a wrong password, you will be prompted to enter the correct password again. To delete or disable the password function, highlight “Supervisor Password” and press <Enter>, instead of typing in a new password. Press the <Esc> key to return to the main menu.

3.1.10 User Password

If you want another user to have access only to your system but not to setup, set a user's password with the "System" option selected in the BIOS Features Setup. If you want a user to enter a password when trying to access setup, set a user's password with the "Setup" option selected in the BIOS Features Setup.

Using user's password to enter Setup allows a user to access only the "User Password" option that appears on the main screen. Access to all other options is denied. To set, confirm, verify, disable or delete a user's password, follow the procedures described in the section "Supervisor Password". If you forget your password, refer to the procedure described in the same section.

3.1.11 IDE HDD Auto Detection

Use this option to detect the parameters for the hard disk drives installed in your system. These parameters will then be automatically entered into the "Standard CMOS Setup". The IDE HDD Auto Detection screen displays the following categories of information: Size, Cylinders, Heads, Precomp, LandZone, Sectors and Mode.

ROM PCI/ISA BIOS
CMOS SETUP UTILITY
AWARD SOFTWARE, INC.

HARD DISKS	TYPE	SIZE	CYLS	HEAD	RECOMP	LANDZ	SECTOR	MODE
Primary Master:								
Select Primary Master Option (N=Skip): N								
OPTIONS	SIZE	CYLS	HEAD	RECOMP	LANDZ	SECTOR	MODE	
2 (Y)	853	827	32	0	1653	63	LBA	
1	853	1654	16	65535	1653	63	Normal	
3	853	827	32	65536	1653	63	Large	
Note: Some OS (like SCO-UNIX) must be "NORMAL" for installation								
ESC: Skip								

The settings on the screen are for reference only. Your version may not be identical to this one.

For hard drives larger than 528MB, you would typically select the LBA type. Certain operating systems require that you select Normal or Large. Please check your operating system's manual or Help desk on which one to select.

3.1.12 Save & Exit Setup

When all the changes have been made, highlight “Save & Exit Setup” and press <Enter>. The message below will appear:

Save to CMOS and Exit (Y/N)? N

Type “Y” and press <Enter>. The modifications you have made will be written into the CMOS memory, and the system will reboot. You will once again see the initial diagnostics on the screen. If you wish to make additional changes to the setup, press <Ctrl> <Alt> <Esc> simultaneously or after memory testing is done.

3.1.13 Exit Without Saving

When you do not want to save the changes you have made, highlight “Exit Without Saving” and press <Enter>. The message below will appear:

Quit Without Saving (Y/N)? N

Type “Y” and press <Enter>. The system will reboot and you will once again see the initial diagnostics on the screen. If you wish to make any changes to the setup, press <Ctrl> <Alt> <Esc> simultaneously or after memory testing is done.

Chapter 4 - Supported Softwares

4.1 Desktop Management Interface (DMI)

The system board comes with a DMI built into the BIOS. DMI, along with the appropriately networked software, is designed to make inventory, maintenance and troubleshooting of computer systems easier. With DMI, a network administrator or MIS engineer can remotely access some information about a particular computer system without physically going to it. Quite often a service call may be unnecessary as the problem can be solved remotely.

The DMI utility in the BIOS automatically records various information about your system configuration. Information about the type and speed of CPU, type and amount of memory for each memory slot, BIOS revision level, types of add-in PCI boards and components, certain revision numbers of hardware installed, etc. are automatically detected and stored in the DMI pool, which is a part of the system board's Plug and Play BIOS. Additional information, such as ISA based peripherals, which may not be automatically detected, can be manually recorded in the DMI pool by using the Add DMI menu. The DMI pool data is then verified or updated whenever the system hardware or setup is altered.

4.1.1 Running the DMI Utility

To run the DMI utility, type: DMICFG.EXE. You can download this utility from <ftp.dfusa.com> - /utilities/DMI directory.

The DMI utility must run in real mode with at least 180K of base memory. Memory managers like HIMEM.SYS (required by Windows) must not be installed. You may do this by using one of the 3 methods listed below.

1. Boot up from a system diskette without the AUTOEXEC.BAT and CONFIG.SYS files,
2. "REM" HIMEM.SYS in the CONFIG.SYS, or
3. Press <F5> during bootup to bypass your AUTOEXEC.BAT and CONFIG.SYS files.

4.1.2 Using the DMI Utility

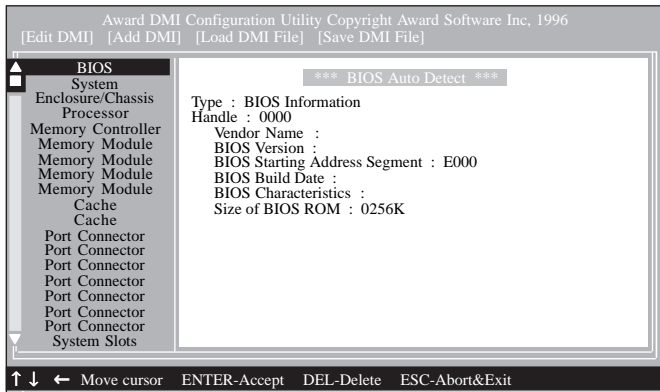

The four menus located on top of the DMI Configuration Utility screen are Edit DMI, Add DMI, Load DMI File and Save DMI File. Use the ← or → (left or right) arrow keys to select a menu from the Menu bar.

On the left side of the screen is a list of the system configuration items. Use the ↑ or ↓ (up or down) arrow keys to select an item.

The commands at the bottom of the screen will allow you to navigate through the various setup menus.

Edit DMI

1. Use the ← or → arrow keys to select the Edit DMI menu.
2. Highlight the item on the left screen that you would like to edit by using the ↑ or ↓ arrow keys, then press <Enter>.
3. The cursor will move to the screen you select allowing you to edit information. The screen will also display the auto-detected information.
4. Press <F10> to update the edited information into the flash ROM.

Add DMI

1. Use the ← or → arrow keys to select the Add DMI menu.
2. Highlight the item on the left screen that you would like to add by using the ↑ or ↓ arrow keys, then press <Enter>.
3. The cursor will move to the screen you select allowing you to enter information about the added item.
4. Press <F10> to save information into the flash ROM.

To view information about the added items, go to the Edit DMI menu.

Load DMI File

1. Use the ← or → arrow keys to select the Load DMI File menu.
2. The following message will appear:
Press [Enter] to select DMI file for load
Press <Enter>.
3. The DMI files will appear on the screen. Select the file you would like to load and press <Enter>.
4. The following message will appear:

Do you want to execute? (Y/N)

Type <Y>. All previous DMI structures will be destroyed and the new file will be saved into the flash ROM.

Save DMI File

1. Use the ← or → arrow keys to select the Save DMI File menu.
2. The following message will appear:
Press [Enter] to select DMI file for save
Press <Enter>.
3. Enter the directory and filename under which you would like the DMI file saved.

4.2 Hardware Doctor Utility

The system board comes with a Hardware Doctor utility contained in the provided CD. This utility is capable of monitoring the system's "health" conditions and allows you to manually set a range (Highest and Lowest Limit) to the items being monitored. If the settings/values are over or under the set range, a warning message will pop-up. The utility can also be configured so that a beeping alarm will sound whenever an error occurs. We recommend that you use the "Default Setting" which is the ideal setting that would keep the system in good working condition.



Note:

Use this utility only in Windows® 95, Windows® 98 and Windows NT® 4.0.

To install the utility, insert the CD (included in the system board package) into a CD-ROM drive. The autorun screen will appear: Double-click the Hardware Doctor icon to install the utility. After installing the utility, the screen below will appear:



(Click here for a clearer view of the screen)

The rightmost column of the screen shows the current value of each monitored item. To set the highest and lowest limit of each item, click on the arrow buttons in the "Lowest Limit" or "Highest Limit" column. However, we **DO NOT** recommend that you change the settings of the Voltages. Make sure to leave them in their default setting.

To further configure the utility, select "Configuration" in the Tools menu. The Monitoring Config. screen will appear.

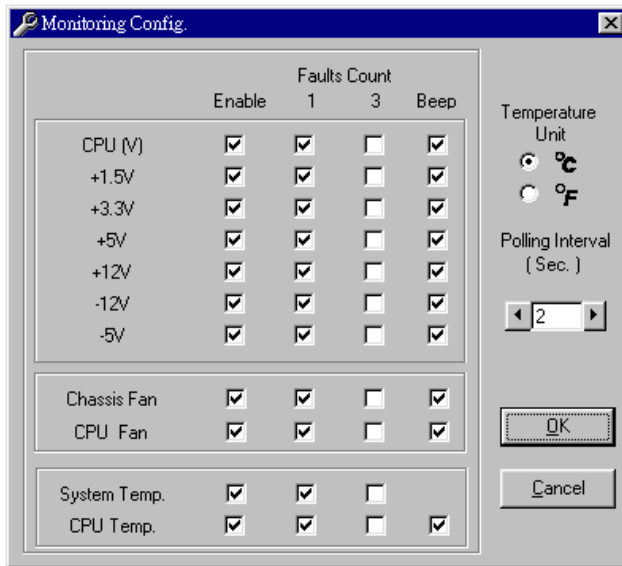

(Click here for a clearer view of the screen)

Enable

Click on the items you want to be monitored.

Faults Count (1 or 3)

This allows you to select the number of fault counts detected before a warning message pop-up. "1" = The warning message will pop-up once an error has been detected. "3" = The warning message will pop-up after the error has been detected thrice.

Beep

Besides the pop-up warning message, you can choose to enable the beep alarm so that if an abnormal condition occurs, an alarm will sound. Due to its hardware limitation, the only item that cannot be enabled is "System Temp". If the internal temperature of the system is too high, only a warning message will pop-up.

Temperature Unit

You can select the temperature unit between Celsius and Fahrenheit. The default unit is Celsius.

Polling Interval

This is used to set the interval for monitoring the system. The range is from 1 sec. to 120 sec. The default interval is 2 sec.

4.3 Drivers and Utility

The CD included in the system board package contains a patch utility, ESS audio drivers and audio application softwares. To view the installation instructions, please insert the CD into a CD-ROM drive. The autorun screen (Main Board Utility CD) will appear. Click "Read me".

Patch Utility for Windows® 95

If you are running Windows® 95 (Win95, Win95+, Win95 OSR1: Windows 95 OEM Service Release 1, Win95 OSR2: Windows 95 OEM Service Release 2.0 or Win95 OSR2.1: Windows 95 OEM Service Release 2.0 plus USB Supplement), you need to run the patch utility.



Important

- 1. You must install this utility in Windows® 95 prior to installing any PCI/ISA drivers.*
- 2. Windows® 98 does not require the patch utility; therefore DO NOT install it in this operating system.*

Appendix A - System Error Message

When the BIOS encounters an error that requires the user to correct something, either a beep code will sound or a message will be displayed in a box in the middle of the screen and the message, PRESS F1 TO CONTINUE, CTRL-ALT-ESC or DEL TO ENTER SETUP, will be shown in the information box at the bottom. Enter Setup to correct the error.

A.1 POST Beep

There are two kinds of beep codes in the BIOS. One code indicates that a video error has occurred and the BIOS cannot initialize the video screen to display any additional information. This beep code consists of a single long beep followed by three short beeps. The other code indicates that a DRAM error has occurred. This beep code consists of a single long beep.

A.2 Error Messages

One or more of the following messages may be displayed if the BIOS detects an error during the POST. This list indicates the error messages for all Awards BIOSes:

CMOS BATTERY HAS FAILED

The CMOS battery is no longer functional. It should be replaced.



Caution:

Danger of explosion if battery incorrectly replaced. Replace only with the same or equivalent type recommended by the manufacturer. Dispose of used batteries according to the battery manufacturer's instructions.

CMOS CHECKSUM ERROR

Checksum of CMOS is incorrect. This can indicate that CMOS has become corrupt. This error may have been caused by a weak battery. Check the battery and replace if necessary.

DISPLAY SWITCH IS SET INCORRECTLY

The display switch on the motherboard can be set to either monochrome or color. This indicates the switch is set to a different

setting than indicated in Setup. Determine which setting is correct, either turn off the system and change the jumper or enter Setup and change the VIDEO selection.

FLOPPY DISK(S) fail (80)

Unable to reset floppy subsystem.

FLOPPY DISK(S) fail (40)

Floppy type mismatch.

Hard Disk(s) fail (80)

HDD reset failed.

Hard Disk(s) fail (40)

HDD controller diagnostics failed.

Hard Disk(s) fail (20)

HDD initialization error.

Hard Disk(s) fail (10)

Unable to recalibrate fixed disk.

Hard Disk(s) fail (08)

Sector Verify failed.

Keyboard is locked out - Unlock the key

The BIOS detects that the keyboard is locked. Keyboard controller is pulled low.

Keyboard error or no keyboard present

Cannot initialize the keyboard. Make sure the keyboard is attached correctly and no keys are being pressed during the boot.

Manufacturing POST loop

System will repeat POST procedure infinitely while the keyboard controller is pull low. This is also used for the M/B burn in test at the factory.

BIOS ROM checksum error - System halted

The checksum of ROM address F0000H-FFFFFFH is bad.

Memory test fail

The BIOS reports memory test fail if the memory has error(s).

Appendix B - Troubleshooting

B.1 Troubleshooting Checklist

This chapter of the manual is designed to help you with problems that you may encounter with your personal computer. To efficiently troubleshoot your system, treat each problem individually. This is to ensure an accurate diagnosis of the problem in case a problem has multiple causes.

Some of the most common things to check when you encounter problems while using your system are listed below.

1. The power switch of each peripheral device is turned on.
2. All cables and power cords are tightly connected.
3. The electrical outlet to which your peripheral devices are connected is working. Test the outlet by plugging in a lamp or other electrical device.
4. The monitor is turned on.
5. The display's brightness and contrast controls are adjusted properly.
6. All add-in boards in the expansion slots are seated securely.
7. Any add-in board you have installed is designed for your system and is set up correctly.

Monitor/Display

If the display screen remains dark after the system is turned on:

1. Make sure that the monitor's power switch is on.
2. Check that one end of the monitor's power cord is properly attached to the monitor and the other end is plugged into a working AC outlet. If necessary, try another outlet.
3. Check that the video input cable is properly attached to the monitor and the system's display adapter.
4. Adjust the brightness of the display by turning the monitor's brightness control knob.

The picture seems to be constantly moving.

1. The monitor has lost its vertical sync. Adjust the monitor's vertical sync.
2. Move away any objects, such as another monitor or fan, that may be creating a magnetic field around the display.
3. Make sure your video card's output frequencies are supported by this monitor.

The screen seems to be constantly wavering.

1. If the monitor is close to another monitor; the adjacent monitor may need to be turned off. Fluorescent lights adjacent to the monitor may also cause screen wavering.

Power Supply

When the computer is turned on, nothing happens.

1. Check that one end of the AC power cord is plugged into a live outlet and the other end properly plugged into the back of the system.
2. Make sure that the voltage selection switch on the back panel is set for the correct type of voltage you are using.
3. The power cord may have a "short" or "open". Inspect the cord and install a new one if necessary.

Floppy Drive

The computer cannot access the floppy drive.

1. The floppy diskette may not be formatted. Format the diskette and try again.
2. The diskette may be write-protected. Use a diskette that is not write-protected.
3. You may be writing to the wrong drive. Check the path statement to make sure you are writing to the targeted drive.
4. There is not enough space left on the diskette. Use another diskette with adequate storage space.

Hard Drive

Hard disk failure.

1. Make sure the correct drive type for the hard disk drive has been entered in the BIOS.
2. If the system is configured with two hard drives, make sure the bootable (first) hard drive is configured as Master and the second hard drive is configured as Slave. The master hard drive must have an active/bootable partition.

Excessively long formatting period.

1. If your hard drive takes an excessively long period of time to format, it is likely a cable connection problem. However, if your hard drive has a large capacity, it will take a longer time to format.

Parallel Port

The parallel printer doesn't respond when you try to print.

1. Make sure that your printer is turned on and that the printer is on-line.
2. Make sure your software is configured for the right type of printer attached.
3. Verify that the onboard LPT port's I/O address and IRQ settings are configured correctly.
4. Verify that the attached device works by attaching it to a parallel port that is working and configured correctly. If it works, the printer can be assumed to be in good condition. If the printer remains inoperative, replace the printer cable and try again.

Serial Port

The serial device (modem, printer) doesn't output anything or is outputting garbled characters.

1. Make sure that the serial device's power is turned on and that the device is on-line.
2. Verify that the device is plugged into the correct serial port on the rear of the computer:
3. Verify that the attached serial device works by attaching it to a serial port that is working and configured correctly. If the serial device does not work, either the cable or the serial device has a problem. If the serial device works, the problem may be due to the onboard I/O or the address setting.
4. Make sure the COM settings and I/O address are configured correctly.

Keyboard

Nothing happens when a key on the keyboard was pressed.

1. Make sure the keyboard is properly connected.
2. Make sure there are no objects resting on the keyboard and that no keys are pressed during the booting process.

System Board

1. Make sure the add-in card is seated securely in the expansion slot. If the add-in card is loose, power off the system, re-install the card and power up the system.
2. Check the jumper settings to ensure that the jumpers are properly set.
3. Verify that all memory modules are seated securely into the memory sockets.
4. Make sure the memory modules are in the correct locations.
5. If the board fails to function, place the board on a flat surface and seat all socketed components. Gently press each component into the socket.
6. If you made changes to the BIOS settings, re-enter setup and load the BIOS defaults.