



- 💣 The author assumes no responsibility for any errors or omissions that may appear in this document nor does the author make a commitment to update the information contained herein.
- 💣 Third-party brands and names are the property of their respective owners.
- 💣 Please do not remove any labels on motherboard, this may void the warranty of this motherboard.
- 💣 Due to rapid change in technology, some of the specifications might be out of date before publication of this booklet.



WARNING: *Never run the processor without the heatsink properly and firmly attached. PERMANENT DAMAGE WILL RESULT!*

Mise en garde : *Ne faites jamais tourner le processeur sans que le dissipateur de chaleur soit fix correctement et fermement. UN DOMMAGE PERMANENT EN RÉULTERA !*

Achtung: *Der Prozessor darf nur in Betrieb genommen werden, wenn der Wärmeableiter ordnungsgemäß und fest angebracht ist. DIES HAT EINEN PERMANENTEN SCHADEN ZUR FOLGE!*

Advertencia: *Nunca haga funcionar el procesador sin el disipador de calor instalado correcta y firmemente. ¡SE PRODUCIRÁ UN DAÑO PERMANENTE!*

Aviso: *Nunca execute o processador sem o dissipador de calor estar adequado e firmemente conectado. O RESULTADO SERÁ UM DANO PERMANENTE!*

警告: 將散熱板牢固地安裝到處理器上之前，不要運行處理器。過熱將永遠損壞處理器！

警告: 將散熱器牢固地安裝到處理器上之前，不要運行處理器。過熱將永遠損壞處理器！

경고: 히트싱크를 제대로 또 단단히 부착시키지 않은 채 프로세서를 구동시키지 마십시오. 영구적 고장이 발생합니다!

警告: 永久的な損傷を防ぐため、ヒートシンクを正しくしっかりと取り付けるまでは、プロセッサを動作させないようにしてください。

GA-6IWF Series
Socket 370 Processor Motherboard

USER'S MANUAL

Socket 370 Processor Motherboard

Rev. 1.0 First Edition

12ME-6IWF-1001

Table of Content

Revision History.....	6
Item Checklist	6
WARNING!	7
Chapter 1 Introduction	8
Summary of Features	8
GA-6IWF Series Motherboard Layout	10
Chapter 2 Hardware Installation Process	11
Step 1: Install the Central Processing Unit (CPU).....	12
Step1-1: CPU Installation	12
Step1-2:CPU Heat Sink Installation	13
Step 2: Install memory modules	14
Step 3: Install expansion cards	15
Step 4: Connect ribbon cables, cabinet wires, and power supply	16
Step4-1:I/O Back Panel Introduction	16
Step4-2: Connectors Introduction	18

Chapter 3 BIOS Setup	23
The Main Menu (For example: BIOS Ver. :F2)	24
Standard CMOS Features	26
BIOS Features Setup	29
Chipset Features Setup	32
Integrated Peripherals	34
Power Management Setup	41
PNP/PCI Configuration	45
PC Health Status	47
Frequency/Voltage Control	49
Load Fail-Safe Defaults	50
Load Optimized Defaults	51
Set Supervisor/User Password	52
Save & Exit Setup	53
Exit Without Saving	54
Chapter 4 Technical Reference	55
Block Diagram	55
@ BIOS Introduction	56
Easy Tunell™ Introduction	57
Chapter 5 Appendix	58

Revision History

Revision	Revision Note	Date
1.0	Initial release of the GA-6IWF Series motherboard user's manual.	Oct .2001

Item Checklist

- The GA-6IWF Series motherboard
- IDE cable x 1/ Floppy cable x 1
- CD for motherboard driver & utility (IUCD)
- GA-6IWF Series user's manual
- I/O Shield

WARNING!

Computer motherboards and expansion cards contain very delicate Integrated Circuit (IC) chips. To protect them against damage from static electricity, you should follow some precautions whenever you work on your computer.

1. Unplug your computer when working on the inside.
2. Use a grounded wrist strap before handling computer components. If you do not have one, touch both of your hands to a safely grounded object or to a metal object, such as the power supply case.
3. Hold components by the edges and try not touch the IC chips, leads or connectors, or other components.
4. Place components on a grounded antistatic pad or on the bag that came with the components whenever the components are separated from the system.
5. Ensure that the ATX power supply is switched off before you plug in or remove the ATX power connector on the motherboard.

Installing the motherboard to the chassis...

If the motherboard has mounting holes, but they don't line up with the holes on the base and there are no slots to attach the spacers, do not become alarmed you can still attach the spacers to the mounting holes. Just cut the bottom portion of the spacers (the spacer may be a little hard to cut off, so be careful of your hands). In this way you can still attach the motherboard to the base without worrying about short circuits. Sometimes you may need to use the plastic springs to isolate the screw from the motherboard PCB surface, because the circuit wire may be near by the hole. Be careful, don't let the screw contact any printed circuit write or parts on the PCB that are near the fixing hole, otherwise it may damage the board or cause board malfunctioning.

Chapter 1 Introduction

Summary of Features

Form Factor	<ul style="list-style-type: none"> • 19.1cm x 23.0cm Flex ATX size form factor, 4 layers PCB.
Motherboard	<ul style="list-style-type: none"> • GA-6IWF Series Motherboard GA-6IWFE and GA-6IWFL
CPU	<ul style="list-style-type: none"> • Socket 370 processor supports all new Pentium®III processors (FC-PGA & FC-PGA2 package) supports Celeron processors in FC-PGA & FC-PGA2 package supports 66/100/133MHz system bus frequency • 2nd cache depend on CPU
Chipset	<ul style="list-style-type: none"> • Intel 82810E HOST/AGP/SDRAM Controller • FW82801BA (ICH2)
Memory	<ul style="list-style-type: none"> • 2 168-pin DIMM sockets • Supports PC-100 SDRAM • Supports only 3.3V SDRAM DIMM • Supports up to 512MB SDRAM (Max)
I/O Control	<ul style="list-style-type: none"> • W83627HF
Slots	<ul style="list-style-type: none"> • 1 CNR(Communication and Networking Riser) Slot • 3 PCI slot supports 33MHz & PCI 2.2 compliant
On-Board IDE	<ul style="list-style-type: none"> • 2 IDE bus master (DMA33/ATA66/ATA100) IDE ports for up to 4 ATAPI devices • Supports PIO mode3,4 (UDMA 33/ATA66/ATA100) IDE & ATAPI CD-ROM
On-Board Peripherals	<ul style="list-style-type: none"> • 1 Floppy port supports 2 FDD with 360K, 720K, 1.2M, 1.44M and 2.88M bytes. • 1 Parallel port supports Normal/EPP/ECP mode • 1 Serial port (COMA) • 1 VGA port • 4 USB ports (Rear USB x 2, Front USB x 2) • 1 IrDA connector for IR

to be continued.....

Hardware Monitor	<ul style="list-style-type: none">• CPU/Power/System Fan Revolution detect• CPU temperature detect• System Voltage Detect
On-Board Sound	<ul style="list-style-type: none">• AC97 CODEC• Line In/Line Out/Mic In/CD In/Game Port
On-Board LAN	<ul style="list-style-type: none">• Build in ICH2 Chipset (KINNERETH 82562ET)*
PS/2 Connector	<ul style="list-style-type: none">• PS/2 Keyboard interface and PS/2 Mouse interace
BIOS	<ul style="list-style-type: none">• Licensed AWARD BIOS, 2M/4M* bit Flash ROM
Additional Features	<ul style="list-style-type: none">• STR(Suspend-To-RAM)• Wake on LAN• USB KB/Mouse wake up from S3-S5• Supports @BIOS™• Supports Easy Tunell™

- Please set the CPU host frequency in accordance with your processor's specifications. We don't recommend you to set the system bus frequency over the CPU's specification because these specific bus frequencies are not the standard specifications for CPU, chipset and most of the peripherals. Whether your system can run under these specific bus frequencies properly will depend on your hardware configurations, including CPU, Chipsets, SDRAM, Cards....etc.

*** Only for GA-6IWFL.

GA-6IWF Series Motherboard Layout

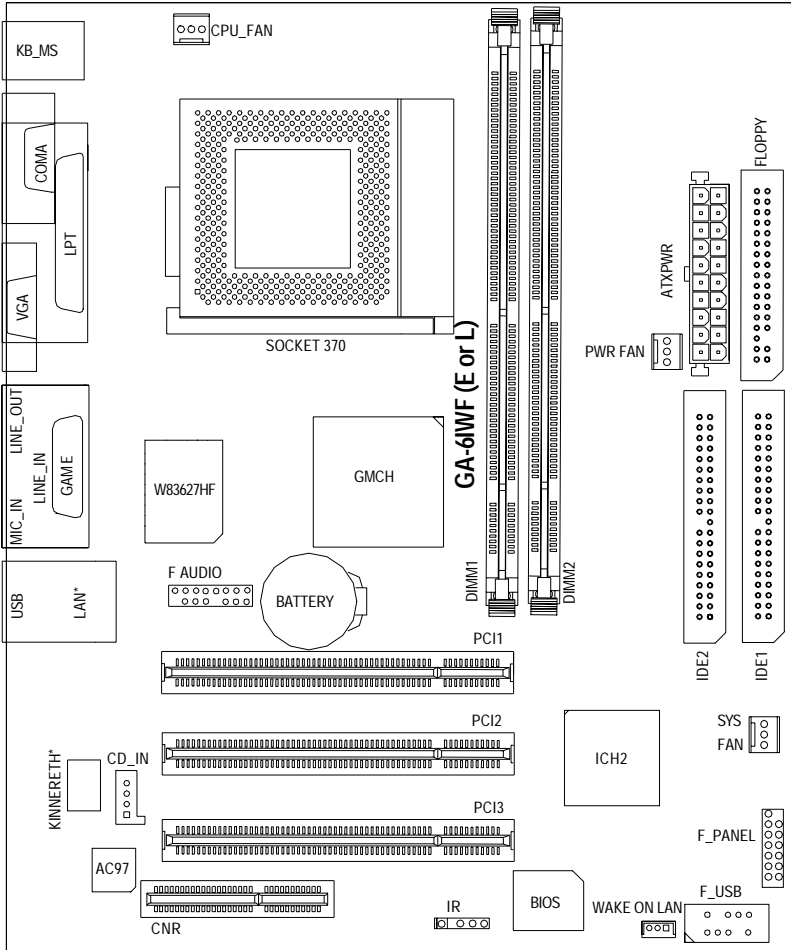

*** Only for GA-6IWF.L.

Chapter 2 Hardware Installation Process

To set up your computer, you must complete the following setups:

- Step 1- Install the Central Processing Unit (CPU)
- Step 2- Install memory modules
- Step 3- Install expansion cards
- Step 4- Connect ribbon cables, cabinet wires, and power supply
- Step 5- Setup BIOS software
- Step 6- Install supporting software tools

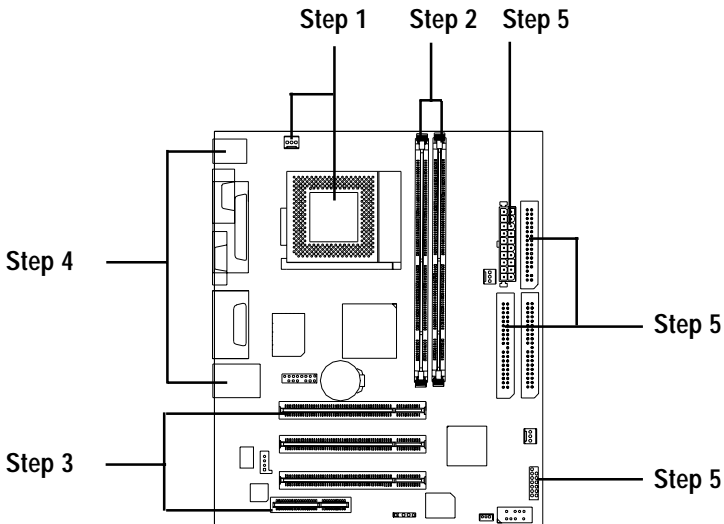

Step 1: Install the Central Processing Unit (CPU)

Step1-1: CPU Installation

For example: The newest Pentium III processor (FC-PGA2 package).



CPU Top View

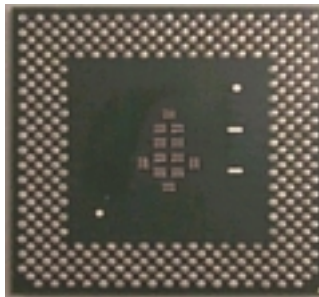

CPU Bottom View

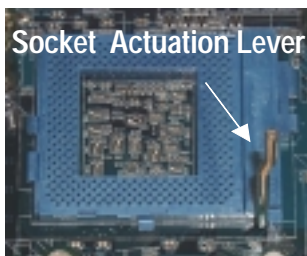

1. Pull up the CPU socket level and up to 90-degree angle.

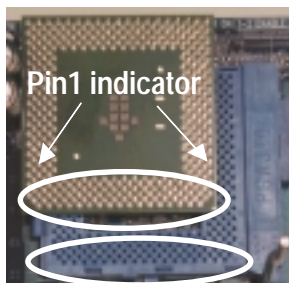

2. Locate Pin 1 in the socket and look for a (golden) cut edge on the CPU upper corner. Then insert the CPU into the socket.

- ⚠ Please make sure the CPU type is supported by the motherboard.
- ⚠ If you do not match the CPU socket Pin 1 and CPU cut edge well, it will cause improper installation. Please change the insert orientation.

Step1-2:CPU Heat Sink Installation



1. Press down the CPU socket lever and finish CPU installation.



2. Use qualified fan approved by Intel.

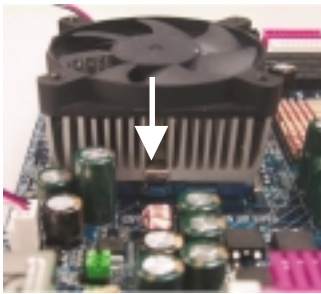

3. Fasten the heatsink supporting-base onto the CPU socket on the main-board.

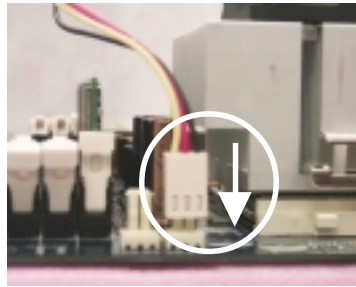

4. Make sure the CPU fan is plugged to the CPU fan connector, than install complete.

- 🔧 Please use Intel approved cooling fan.
- 🔧 We recommend you to apply the thermal paste to provide better heat conduction between your CPU and heatsink.
- 🔧 Make sure the CPU fan power cable is plugged in to the CPU fan connector, this completes the installation.
- 🔧 Please refer to CPU heat sink user's manual for more detail installation procedure.

Step 2: Install memory modules

The motherboard has 2 dual in-line memory module (DIMM) sockets support 4 banks. The BIOS will automatically detects memory type and size. To install the memory module, just push it vertically into the DIMM Slot .The DIMM module can only fit in one direction due to the two notch. Memory size can vary between sockets.



SDRAM

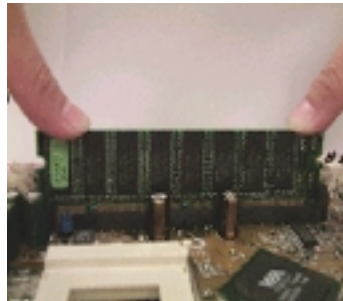
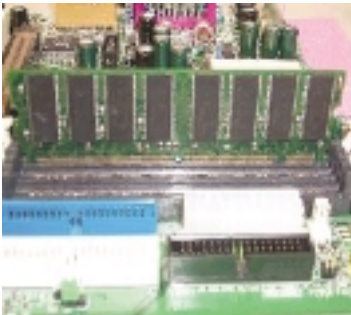

1. The DIMM slot has two notch, so the DIMM memory module can only fit in one direction.
2. Insert the DIMM memory module vertically into the DIMM slot. Then push it down.
3. Close the plastic clip at both edges of the DIMM slots to lock the DIMM module. Reverse the installation steps when you wish to remove the DIMM module.

- ⚠️ When STR/DIMM LED is ON, do not install/remove SDRAM from socket.
- ⚠️ Please note that the DIMM module can only fit in one direction due to the two notches. Wrong orientation will cause improper installation. Please change the insert orientation.

Step 3: Install expansion cards

1. Read the related expansion card's instruction document before install the expansion card into the computer.
2. Remove your computer's chassis cover, necessary screws and slot bracket from the computer.
3. Press the expansion card firmly into expansion slot in motherboard.
4. Be sure the metal contacts on the card are indeed seated in the slot.
5. Replace the screw to secure the slot bracket of the expansion card.
6. Replace your computer's chassis cover.
7. Power on the computer, if necessary, setup BIOS utility of expansion card from BIOS.
8. Install related driver from the operating system.

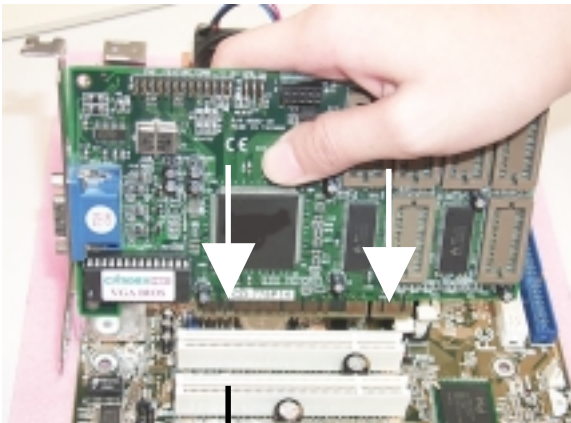

PCI Slot

Step 4: Connect ribbon cables, cabinet wires, and power supply

Step4-1:I/O Back Panel Introduction

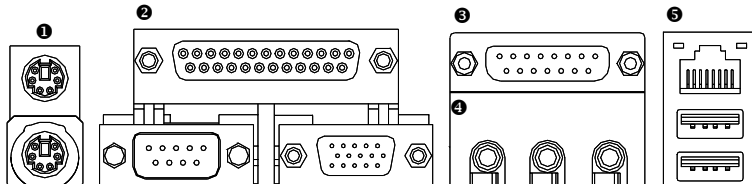

❶ PS/2 Keyboard and PS/2 Mouse Connector

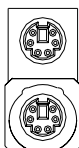

PS/2 Mouse Connector
(6 pin Female)

PS/2 Keyboard Connector
(6 pin Female)

➤ This connector supports standard PS/2 keyboard and PS/2 mouse.

❷ Parallel Port , Serial Port and VGA Port (LPT/COMA/VGA)

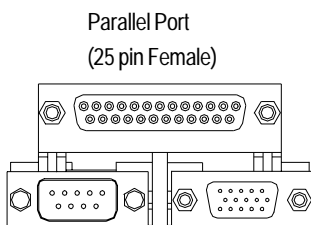

Parallel Port
(25 pin Female)

COMA
Serial Port
(9 pin Male)

VGA
VGA Port
(15 pin Female)

➤ This connector supports 1 standard COM port ,1 Parallel port and 1 VGA port. Device like printer can be connected to Parallel port ; mouse and modem etc can be connected to Serial ports.

3 Game /MIDI Ports

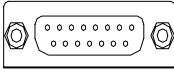

Joystick/ MIDI (15 pin Female)

- This connector supports joystick, MIDI keyboard and other relate audio devices.

4 Audio Connectors

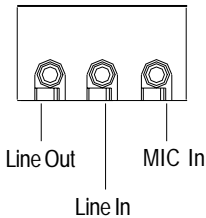

- After install onboard audio driver, you may connect speaker to Line Out jack, micro phone to MIC In jack. Device like CD-ROM , walkman etc can be connected to Line-In jack.

5 USB & LAN Connector

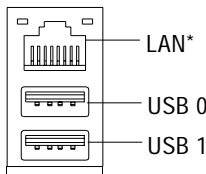

- Before you connect your device(s) into USB connector(s), please make sure your device(s) such as USB keyboard, mouse, scanner, zip, speaker..etc. Have a standard USB interface. Also make sure your OS (Win 95 with USB supplement, Win98, Windows 2000, Windows ME, Win NT with SP 6) supports USB controller. If your OS does not support USB controller, please contact OS vendor for possible patch or driver upgrade. For more information please contact your OS or device(s) vendors.

*** Only for GA-6IWFL.

Step4-2: Connectors Introduction

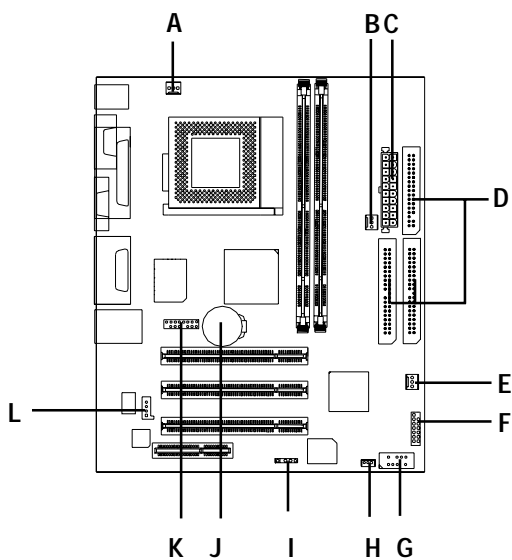

A) CPU FAN	H) WAKE ON LAN
B) PWR FAN	I) IR
C) ATXPWR	J) BATTERY
D) Floppy/IDE1/IDE2	K) F_AUDIO
E) SYS FAN	L) CD_IN
F) F_PANEL	
G) F_USB	

A) CPU_FAN (CPU_FAN Connector)



- The CPU fan connector supports Max. current up to 600 mA .

E) SYS_FAN (SYS_FAN Connector)



B) PWR_FAN (PWR_FAN Connector)



H) WAKE ON LAN

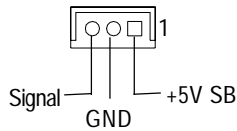

C) ATX PWR (ATX Power)

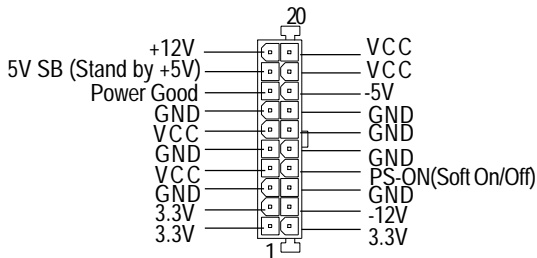

- AC power cord should only be connected to your power supply unit after ATX power cable and other related devices are firmly connected to the mainboard.

D) Floppy / IDE1 / IDE2

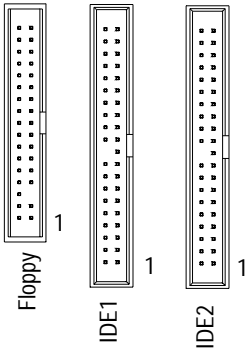

I) IR

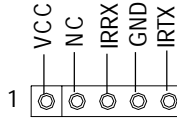

- Be careful with the polarity of the IR connector while you connect the IR. Please contact you nearest dealer for optional IR device.

K) Front Audio Connector

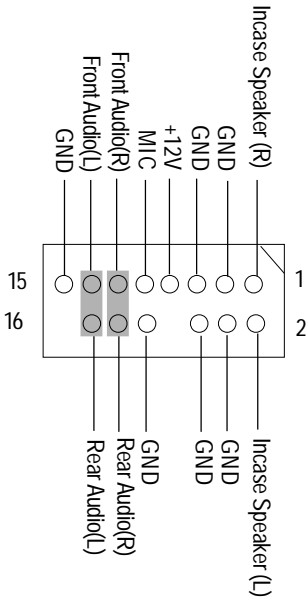

- If you want to use "Front Audio" connector, you must move 11-12,13-14 Jumper. In order to utilize the front audio header, your chassis must have front audio connector. Also please make sure the pin assigment on the cable is the same as the pin assigment on the MB header. To find out if the chassis you are buying support front audio connector, please contact your dealer.

G) F_USB

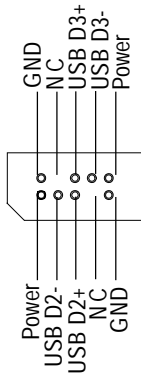

- Be careful with the polarity of the front panel USB connector. Check the pin assignment while you connect the front panel USB cable. Please contact your nearest dealer for optional front panel USB cable.

J) Battery

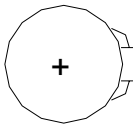

CAUTION

- ❖ Danger of explosion if battery is incorrectly replaced.
- ❖ Replace only with the same or equivalent type recommended by the manufacturer.
- ❖ Dispose of used batteries according to the manufacturer's instructions.

L) CD_IN

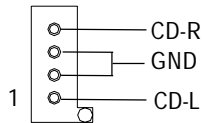

F) F_PANEL (2x7 pins jumper)

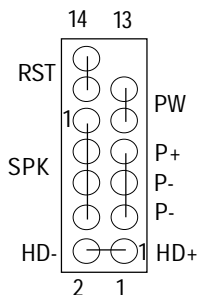

HD (IDE Hard Disk Active LED)	Pin 1: LED anode(+) Pin 2: LED cathode(-)
SPK (Speaker Connector)	Pin 1: VCC(+) Pin 2- Pin 3: NC Pin 4: Data(-)
RST (Reset Switch)	Open: Normal Operation Close: Reset Hardware System
P+P-P-(Power LED)	Pin 1: LED anode(+) Pin 2: LED cathode(-) Pin 3: LED cathode(-)
PW (Soft Power Connector)	Open: Normal Operation Close: Power On/Off

- Please connect the power LED, PC speaker, reset switch and power switch etc of your chassis front panel to the front panel jumper according to the pin assignment above.

Chapter 3 BIOS Setup

BIOS Setup is an overview of the BIOS Setup Program. The program that allows users to modify the basic system configuration. This type of information is stored in battery-backed CMOS RAM so that it retains the Setup information when the power is turned off.

ENTERINGSETUP

Power ON the computer and press immediately will allow you to enter Setup. If the message disappears before you respond and you still wish to enter Setup, restart the system to try again by turning it OFF then ON or pressing the "RESET" bottom on the system case. You may also restart by simultaneously press <Ctrl> - <Alt>- keys.

CONTROLKEYS

<↑>	Move to previous item
<↓>	Move to next item
<←>	Move to the item in the left hand
<→>	Move to the item in the right hand
<Esc>	Main Menu - Quit and not save changes into CMOS Status Page Setup Menu and Option Page Setup Menu - Exit current page and return to Main Menu
<+/PgUp>	Increase the numeric value or make changes
<-/PgDn>	Decrease the numeric value or make changes
<F1>	General help, only for Status Page Setup Menu and Option Page Setup Menu
<F2>	Reserved
<F3>	Reserved
<F4>	Reserved
<F5>	Restore the previous CMOS value from CMOS, only for Option Page Setup Menu
<F6>	Load the default CMOS value from BIOS default table, only for Option Page Setup Menu
<F7>	Load the Setup Defaults
<F8>	Reserved
<F9>	Reserved
<F10>	Save all the CMOS changes, only for Main Menu

GETTINGHELP

Main Menu

The on-line description of the highlighted setup function is displayed at the bottom of the screen.

Status Page Setup Menu / Option Page Setup Menu

Press F1 to pop up a small help window that describes the appropriate keys to use and the possible selections for the highlighted item. To exit the Help Window press <Esc>.

The Main Menu (For example: BIOS Ver. :F2)

Once you enter AWARD BIOS CMOS Setup Utility, the Main Menu (Figure 1) will appear on the screen. The Main Menu allows you to select from eight setup functions and two exit choices. Use arrow keys to select among the items and press <Enter> to accept or enter the sub-menu.

CMOS Setup Utility-Copyright (C) 1984-2001 Award Software

▶Standard CMOS Features	▶Frequency/Voltage Control
▶Advanced BIOS Features	Load Fail-Safe Defaults
▶Advanced Chipset Features	Load Optimized Defaults
▶Integrated Peripherals	Set Supervisor Password
▶Power Management Setup	Set User Password
▶PnP/PCI Configurations	Save & Exit Setup
▶PC Health Status	Exit Without Saving
ESC:Quit	↑↓→←:Select Item
F10:Save & Exit Setup	
Time, Date, Hard Disk Type...	

Figure 1: Main Menu

- **Standard CMOS Features**

This setup page includes all the items in standard compatible BIOS.

- **Advanced BIOS Features**

This setup page includes all the items of Award special enhanced features.

- **Advanced Chipset Features**

This setup page includes all the items of chipset special features.

- **Integrated Peripherals**
This setup page includes all onboard peripherals.
- **Power Management Setup**
This setup page includes all the items of Green function features.
- **PnP/PCI Configurations**
This setup page includes all the configurations of PCI & PnP ISA resources.
- **PC Health Status**
This setup page is the System auto detect Temperature, voltage, fan, speed.
- **Frequency/Voltage Control**
This setup page is control CPU's clock and frequency ratio.
- **Load Fail-Safe Defaults**
Fail-Safe Defaults indicates the value of the system parameters which the system would be in safe configuration.
- **Load Optimized Defaults**
Optimized Defaults indicates the value of the system parameters which the system would be in best performance configuration.
- **Set Supervisor password**
Change, set, or disable password. It allows you to limit access to the system and Setup, or just to Setup.
- **Set User password**
Change, set, or disable password. It allows you to limit access to the system.
- **Save & Exit Setup**
Save CMOS value settings to CMOS and exit setup.
- **Exit Without Saving**
Abandon all CMOS value changes and exit setup.

Standard CMOS Features

CMOS Setup Utility-Copyright (C) 1984-2001 Award Software

Standard CMOS Features

Date (mm:dd:yy)	Mon, Feb 21 2000	Item Help
Time (hh:mm:ss)	22:31:24	Menu Level
▶IDE Primary Master	Press Enter None	
▶IDE Primary Slave	Press Enter None	
▶IDE Secondary Master	Press Enter None	
▶IDE Secondary Slave	Press Enter None	
Drive A	1.44M, 3.5 in.	
Drive B	None	
Floppy 3 Mode Support	Disabled	
Halt On	All, But Keyboard	
Base Memory	640K	
Extended Memory	130048K	
Total Memory	131072K	
↑ ↓ → ← : Move Enter:Select +/-/PU/PD:Value F10:Save ESC:Exit F1:General Help F5:Previous Values F6:Fail-Safe Defaults F7:Optimized Defaults		

Figure 2: Standard CMOS Features

Date

The date format is <month>, <day>, <year>, <week>.

- ▶▶ Month The month, Jan. Through Dec.
- ▶▶ Day The day, from 1 to 31 (or the maximum allowed in the month)
- ▶▶ Year The year, from 1990 through 2099
- ▶▶ Week The week, from Sun to Sat, determined by the BIOS and is display only

☛ Time

The times format in <hour> <minute> <second>. The time is calculated base on the 24-hour military-time clock. For example, 1 p.m. is 13:00:00.

☛ Primary Master, Slave / Secondary Master, Slave

The category identifies the types of hard disk from drive C to F that has been installed in the computer. There are two types: auto type, and manual type. Manual type is user-definable; Auto type which will automatically detect HDD type.

Note that the specifications of your drive must match with the drive table. The hard disk will not work properly if you enter improper information for this category.

If you select User Type, related information will be asked to enter to the following items. Enter the information directly from the keyboard and press <Enter>. Such information should be provided in the documentation form your hard disk vendor or the system manufacturer.

▶▶ CYLS.	Number of cylinders
▶▶ HEADS	number of heads
▶▶ PRECOMP	write precomp
▶▶ LANDZONE	Landing zone
▶▶ SECTORS	number of sectors

If a hard disk has not been installed select NONE and press <Enter>.

☛ Floppy Drive A / Drive B

The category identifies the types of floppy disk drive A or drive B that has been installed in the computer.

▶▶ None	No floppy drive installed
▶▶ 360K, 5.25 in.	5.25 inch PC-type standard drive; 360K byte capacity.
▶▶ 1.2M, 5.25 in.	5.25 inch AT-type high-density drive; 1.2M byte capacity (3.5 inch when 3 Mode is Enabled).
▶▶ 720K, 3.5 in.	3.5 inch double-sided drive; 720K byte capacity
▶▶ 1.44M, 3.5 in.	3.5 inch double-sided drive; 1.44M byte capacity.
▶▶ 2.88M, 3.5 in.	3.5 inch double-sided drive; 2.88M byte capacity.

Floppy 3 Mode Support (for Japan Area)

- ▶▶ Disabled Normal Floppy Drive. (Default value)
- ▶▶ Drive A Drive A is 3 mode Floppy Drive.
- ▶▶ Drive B Drive B is 3 mode Floppy Drive.
- ▶▶ Both Drive A & B are 3 mode Floppy Drives.

Halt on

The category determines whether the computer will stop if an error is detected during power up.

- ▶▶ NO Errors The system boot will not stop for any error that may be detected and you will be prompted.
- ▶▶ All Errors Whenever the BIOS detects a non-fatal error the system will be stopped.
- ▶▶ All, But Keyboard The system boot will not stop for a keyboard error; it will stop for all other errors. (Default value)
- ▶▶ All, But Diskette The system boot will not stop for a disk error; it will stop for all other errors.
- ▶▶ All, But Disk/Key The system boot will not stop for a keyboard or disk error; it will stop for all other errors.

Memory

The category is display-only which is determined by POST (Power On Self Test) of the BIOS.

Base Memory

The POST of the BIOS will determine the amount of base (or conventional) memory installed in the system.

The value of the base memory is typically 512 K for systems with 512 K memory installed on the motherboard, or 640 K for systems with 640 K or more memory installed on the motherboard.

Extended Memory

The BIOS determines how much extended memory is present during the POST.

This is the amount of memory located above 1 MB in the CPU's memory address map.

BIOS Features Setup

CMOS Setup Utility-Copyright (C) 1984-2001 Award Software

Advanced BIOS Features

BIOS Flash Protection	Auto	Item Help
Processor Serial Number	Disabled	Menu Level
First Boot Device	Floppy	
Second Boot Device	HDD-0	
Third Boot Device	CDROM	
Boot Up Floppy Seek	Disabled	
Boot Up Num-Lock	On	
Password Check	Setup	
MPS Version Control For OS	1.4	
HDD S.M.A.R.T. Capability	Disabled	
↑↓ → ← : Move Enter:Select +/-/PU/PD:Value F10:Save ESC:Exit F1:General Help F5:Previous Values F6:Fail-Safe Defaults F7:Optimized Defaults		

Figure 3: Advanced BIOS Features

☞ BIOS Flash Protection

This field lets you determine the states that flash BIOS.

- ▶▶ Auto BIOS enables flash write access automatically when updating BIOS data/DMI/ESCD. (Default Value)
- ▶▶ Enabled During POST, DMI/ESCD would not be updated. But flash tools can update BIOS always.

☞ Processor Serial Number

- ▶▶ Enabled Pentium III Processor Serial Number .
- ▶▶ Disabled Disable this function.(Default Value)

☞ First / Second / Third Boot device

- ▶▶ Floppy Select your boot device priority by Floppy.
- ▶▶ LS120 Select your boot device priority by LS120.
- ▶▶ HDD-0-3 Select your boot device priority by HDD-0-3.

- ▶▶ SCSI Select your boot device priority by SCSI.
- ▶▶ CDROM Select your boot device priority by CDROM.
- ▶▶ ZIP Select your boot device priority by ZIP.
- ▶▶ USB-FDD Select your boot device priority by USB-FDD.
- ▶▶ USB-ZIP Select your boot device priority by USB-ZIP.
- ▶▶ USB-CDROM Select your boot device priority by USB-CDROM.
- ▶▶ USB-HDD Select your boot device priority by USB-HDD.
- ▶▶ LAN Select your boot device priority by LAN.
- ▶▶ Disabled Select your boot device priority by Disabled.

☞ **Boot Up Floppy Seek**

During POST, BIOS will determine the floppy disk drive installed is 40 or 80 tracks. 360 K type is 40 tracks 720 K, 1.2 M and 1.44 M are all 80 tracks.

- ▶▶ Enabled BIOS searches for floppy disk drive to determine it is 40 or 80 tracks. Note that BIOS can not tell from 720 K, 1.2 M or 1.44 M drive type as they are all 80tracks.
- ▶▶ Disabled BIOS will not search for the type of floppy disk drive by track number. Note that there will not be any warning message if the drive installed is 360 K. (Default value)

☞ **Boot Up NumLock**

- ▶▶ On Keypad is number keys. (Default value)
- ▶▶ Off Keypad is arrow keys.

☞ **Password Check**

This category allows you to limit access to the system and Setup, or just to Setup.

- ▶▶ System The system can not boot and can not access to Setup page will be denied if the correct password is not entered at the prompt.
- ▶▶ Setup The system will boot, but access to Setup will be denied if the correct password is not entered at the prompt. (Default value)

☞ **MPS Version Control For OS**

(Support Multi Processor Specification revision 1.4)

- ▶▶ 1.4 Support MPS Version 1.4 . (Default Value)
- ▶▶ 1.1 Support MPS Version 1.1.

☞ **HDD S.M.A.R.T. Capability**

- ▶▶ Enabled Enabled HDD S.M.A.R.T. Capability.
- ▶▶ Disabled Disabled HDD S.M.A.R.T. Capability. (Default value)

Chipset Features Setup

CMOS Setup Utility-Copyright (C) 1984-2001 Award Software

Advanced Chipset Features

SDRAM CAS Latency Time	Auto	Item Help
SDRAM Cycle Time Trac/Trc	Auto	Menu Level
SDRAM RAS-to-CAS Delay	Auto	
SDRAM RAS Precharge Time	Auto	
Delay Transaction	Enable	
AGP Graphics Aperture Size	64MB	
↑↓→←: Move Enter:Select +/-PU/PD:Value F10:Save ESC:Exit F1:General Help F5:Previous Values F6:Fail-Safe Defaults F7:Optimized Defaults		

Figure 4: Advanced Chipset Features

☞ SDRAM CAS latency Time

- ▶▶3 For Slower SDRAM DIMM module.
- ▶▶2 For Fastest SDRAM DIMM module.
- ▶▶Auto Set SDRAM CAS latency to Auto.(Default value)

☞ SDRAM Cycle Time Trac/Trc

- ▶▶5/7 Set SDRAM Cycle Time Trac/Trc to 5/7SCLKs.
- ▶▶6/8 Set SDRAM Cycle Time Trac/Trc to 6/8SCLKs.
- ▶▶Auto Set SDRAM Cycle Time Trac/Trc to Auto.(Default value)

☞ SDRAM RAS- to-CAS Delay

- ▶▶3 Set SDRAM RAS-to-CAS delay 3 SCLKs.
- ▶▶2 Set SDRAM RAS-to-CAS delay 2 SCLKs.
- ▶▶Auto Set SDRAM RAS-to-CAS delay to Auto.(Default value)

☞ SDRAM RAS Precharge Time

- ▶▶ 3 Set SDRAM RAS Precharge Time to 3.
- ▶▶ 2 Set SDRAM RAS Precharge Time to 2.
- ▶▶ Auto Set SDRAM RAS Precharge to Auto.(Default value)

☞ Delay Transaction

- ▶▶ Enabled Enabled PCI Delay Transaction. (Default Value)
- ▶▶ Disabled Disabled PCI Delay Transaction.

☞ AGP Graphics Aperture Size (MB)

- ▶▶ 64 Set AGP Graphics Aperture Size to 64 MB. (Default Value)
- ▶▶ Disabled Disable this function.

Integrated Peripherals

CMOS Setup Utility-Copyright (C) 1984-2001 Award Software

Integrated Peripherals

IDE1 Conductor Cable	Auto	Item Help
IDE2 Conductor Cable	Auto	Menu Level
On-Chip Primary PCI IDE	Enabled	
On-Chip Secondary PCI IDE	Enabled	
IDE Primary Master PIO	Auto	
IDE Primary Slave PIO	Auto	
IDE Secondary Master PIO	Auto	
IDE Secondary Slave PIO	Auto	
IDE Primary Master UDMA	Auto	
IDE Primary Slave UDMA	Auto	
IDE Secondary Master UDMA	Auto	
IDE Secondary Slave UDMA	Auto	
USB Controller	Enabled	
USB Keyboard Support	Disabled	
USB Mouse Support	Disabled	
Init Display First	PCI Slot	
AC97 Audio	Auto	
Mouse power on	Disabled	
Keyboard power on	Disabled	
※KB Power ON Password	Enter	
Onboard FDC Controller	Enabled	
Onboard Serial Port 1	3F8/IRQ4	
Onboard Serial Port 2	2F8/IRQ3	
UART Mode Select	Normal	
※RxD,TxD Active	Hi,Lo	
※IR Transaction Delay	Enabled	
※UR2 Duplex Mode	Half	
※Use IR Pins	IR-Rx2Tx2	
Onboard Parallel Port	378/IRQ7	
Parallel Port Mode	SPP	

×EPP Mode Select	EPP1.7	
×ECP Mode Use DMA	3	
AC BACK Function	Soft-Off	
Game Port Address	201	
Midi Port Address	330	
Midi Port IRQ	10	
↑↓→←: Move Enter:Select +/-/PU/PD:Value F10:Save ESC:Exit F1:General Help F5:Previous Values F6:Fail-Safe Defaults F7:Optimized Defaults		

Figure 5: Integrated Peripherals

☞ IDE 1 Conductor Cable

- ▶▶Auto Set IDE 1 Conductor cable to auto.(Default value)
- ▶▶ATA66/100 Set IDE 1 Conductor cable to ATA66/100.
- ▶▶ATA33 IDE 1 Conductor cable to ATA33.

☞ IDE 2 Conductor Cable

- ▶▶Auto Set IDE 2 Conductor cable to auto.(Default value)
- ▶▶ATA66/100 Set IDE 2 Conductor cable to ATA66/100.
- ▶▶ATA33 IDE 2 Conductor cable to ATA33.

☞ On-Chip Primary PCI IDE

- ▶▶Enabled Enable onboard 1st channel IDE port. (Default value)
- ▶▶Disabled Disable onboard 1st channel IDE port.

☞ On-Chip Secondary PCI IDE

- ▶▶Enabled Enable onboard 2nd channel IDE port. (Default value)
- ▶▶Disabled Disable onboard 2nd channel IDE port.

☞ IDE Primary Master PIO (for onboard IDE 1st channel)

- ▶▶Auto BIOS will automatically detect the IDE HDD Accessing mode.
(Default value)
- ▶▶Mode0-4 Manually set the IDE Accessing mode.

☞ **IDE Primary Slave PIO (for onboard IDE 1st channel)**

- ▶▶ Auto BIOS will automatically detect the IDE HDD Accessing mode.
(Default value)
- ▶▶ Mode0-4 Manually set the IDE Accessing mode.

☞ **IDE Secondary Master PIO (for onboard IDE 2nd channel)**

- ▶▶ Auto BIOS will automatically detect the IDE HDD Accessing mode.
(Default value)
- ▶▶ Mode0-4 Manually set the IDE Accessing mode.

☞ **IDE Primary Master UDMA**

- ▶▶ Auto BIOS will automatically detect the IDE HDD Accessing mode.
(Default value)
- ▶▶ Disabled Disable UDMA function.

☞ **IDE Primary Slave UDMA**

- ▶▶ Auto BIOS will automatically detect the IDE HDD Accessing mode.
(Default value)
- ▶▶ Disabled Disable UDMA function.

☞ **IDE Secondary Master UDMA**

- ▶▶ Auto BIOS will automatically detect the IDE HDD Accessing mode. (Default value)
- ▶▶ Disabled Disable UDMA function.

☞ **IDE Secondary Slave UDMA**

- ▶▶ Auto BIOS will automatically detect the IDE HDD Accessing mode. (Default value)
- ▶▶ Disabled Disable UDMA function.

☞ **USB Controller**

- ▶▶ Enabled Enabled USB Controller. (Default value)
- ▶▶ Disabled Disabled USB Controller.

☞ USB Keyboard Support

- ▶▶ Enabled Enabled USB Keyboard Support.
- ▶▶ Disabled Disabled USB Keyboard Support. (Default value)

☞ USB Mouse Support

- ▶▶ Enabled Enabled USB Mouse Support.
- ▶▶ Disabled Disabled USB Mouse Support. (Default value)

☞ Init Display First

- ▶▶ PCI Slot Set Init Display First to PCI Slot.(Default value)
- ▶▶ AGP Set Init Display First to AGP.

☞ AC97 Audio

- ▶▶ Auto BIOS will automatically detect onboard AC97 Audio or Creative CT5880 audio. (Default value)
- ▶▶ Disabled Disabled AC97 Audio.

☞ AC97 Modem

- ▶▶ Auto Bios will automatically detect onboard AC97 Modem. (Default value)
- ▶▶ Disabled Disabled AC97 Modem.

☞ Mouse Power On

- ▶▶ Disabled Disabled this function. (Default value)
- ▶▶ Mouse Click Power On by Mouse click.

☞ Keyboard Power On

- ▶▶ Password Enter from 1 to 5 characters to set the Keyboard Power On Password.
- ▶▶ Disabled Disabled this function. (Default value)
- ▶▶ Keyboard 98 If your keyboard have "POWER Key" button, you can press the key to power on your system.

☞ **KB Power ON Password**

- ▶▶ Enter Input password (from 1 to 5 characters) and press Enter to set the Key board Power On Password.

☞ **Onboard FDC Controller**

- ▶▶ Enabled Enable onboard FDC port. (Default value)
- ▶▶ Disabled Disable onboard FDC port.

☞ **Onboard Serial Port 1**

- ▶▶ Auto BIOS will automatically setup the port 1 address.
- ▶▶ 3F8/IRQ4 Enable onboard Serial port 1 and address is 3F8. (Default value)
- ▶▶ 2F8/IRQ3 Enable onboard Serial port 1 and address is 2F8.
- ▶▶ 3E8/IRQ4 Enable onboard Serial port 1 and address is 3E8.
- ▶▶ 2E8/IRQ3 Enable onboard Serial port 1 and address is 2E8.
- ▶▶ Disabled Disable onboard Serial port 1.

☞ **Onboard Serial Port 2**

- ▶▶ Auto BIOS will automatically setup the port 2 address.
- ▶▶ 3F8/IRQ4 Enable onboard Serial port 2 and address is 3F8.
- ▶▶ 2F8/IRQ3 Enable onboard Serial port 2 and address is 2F8. (Default Value)
- ▶▶ 3E8/IRQ4 Enable onboard Serial port 2 and address is 3E8.
- ▶▶ 2E8/IRQ3 Enable onboard Serial port 2 and address is 2E8.
- ▶▶ Disabled Disable onboard Serial port 2.

☞ **UART Mode Select**

(This item allows you to determine which Infra Red(IR) function of Onboard I/O chip)

- ▶▶ ASKIR Set onboard I/O chip UART to ASKIR Mode.
- ▶▶ IrDA Set onboard I/O chip UART to IrDA Mode.
- ▶▶ SCR Set onboard I/O chip UART to SCR Mode.
- ▶▶ Normal Set onboard I/O chip UART to Normal Mode. (Default Value)

☞ **RxD, TxD Active**

- ▶▶ Hi, Hi Set RxD,TxD Active to Hi, Hi.
- ▶▶ Hi, Lo Set RxD,TxD Active to Hi, Lo. (Default Value)
- ▶▶ Lo, Hi Set RxD,TxD Active to Lo, Hi.
- ▶▶ Lo, Lo Set RxD,TxD Active to Lo, Lo.

☞ **IR Transmission Delay**

- ▶▶ Enabled Enabled IR Transmission delay. (Default Value)
- ▶▶ Disabled Enabled IR Transmission delay.

☞ **Use IR Pins**

- ▶▶ IR-Rx2Tx2 Enable On Board LPT port and address is 378.(Default Value)
- ▶▶ RxD2,TxD2 Enable On Board LPT port and address is 278.

☞ **Onboard Parallel port**

- ▶▶ 378/IRQ7 Enable onboard LPT port and address is 378/IRQ7. (Default Value)
- ▶▶ 278/IRQ5 Enable onboard LPT port and address is 278/IRQ5.
- ▶▶ 3BC/IRQ7 Enable onboard LPT port and address is 3BC/IRQ7.
- ▶▶ Disabled Disable onboard LPT port.

☞ **Onboard Parallel Mode**

- ▶▶ Normal Using Parallel port as Normal.
- ▶▶ EPP Using Parallel port as Enhanced Parallel Port.
- ▶▶ ECP Using Parallel port as Extended Capabilities Port. (Default Value)
- ▶▶ ECP/EPP Using Parallel port as ECP & EPP mode.

☞ **Parallel Port EPP Type**

- ▶▶ EPP 1.9 EPP Version is 1.9. (Default Value)
- ▶▶ EPP 1.7 EPP Version is 1.7.

☞ **ECP Mode Use DMA**

- ▶▶ 3 ECP Mode Use DMA 3 (Default Value)
- ▶▶ 1 ECP Mode Use DMA 1

☞ **AC Back Function**

- ▶▶ Memory System power on depends on the status before AC lost.
- ▶▶ Soft-Off Always in Off state when AC back. (Default value)
- ▶▶ Full-On Always power on the system when AC back.

☞ **Game Port Address**

- ▶▶ Disabled Disabled this function.
- ▶▶ 201 Set Game Port Address to 201.(Default Value)
- ▶▶ 209 Set Game Port Address to 209.

☞ **Midi Port Address**

- ▶▶ Disabled Disabled this function.
- ▶▶ 330 Set Game Port Address to 330.(Default Value)
- ▶▶ 300 Set Game Port Address to 300.

☞ **Midi Port IRQ**

- ▶▶ 5 Set 5 for Midi Port IRQ.
- ▶▶ 10 Set 10 for Midi Port IRQ. (Default Value)

Power Management Setup

CMOS Setup Utility-Copyright (C) 1984-2001 Award Software

Power Management Setup

ACPI Suspend Type	S1(POS)	Item Help
Power Management	User Define	Menu Level
Video Off Method	DPMS	
Video Off In Suspend	Yes	
Suspend Type	Stop Grant	
MODEM Use IRQ	NA	
Suspend Mode	Disabled	
HDD Power Down	Disabled	
Soft-Off by PWR-BTTN	Instant-off	
PME Event Wake Up	Disabled	
ModemRingOn/WakeOnLan	Enabled	
× USB Device Wake-Up From S3	Disabled	
CPU Thermal-Throttling	50%	
Resume by Alarm	Disabled	
× Date(of Month) Alarm	Everyday	
× Time(hh:mm:ss) Alarm	0 0 0	
** Reload Global Timer Events **		
Primary IDE 0	Disabled	
Primary IDE 1	Disabled	
Secondary IDE 0	Disabled	
Secondary IDE 1	Disabled	
FDD,COM,LPT Port	Disabled	
PCI PIRQ[A-D]#	Disabled	
↑↓ → ← : Move Enter:Select +/-/PU/PD:Value F10:Save ESC:Exit F1:General Help F5:Previous Values F6:Fail-Safe Defaults F7:Optimized Defaults		

Figure 6: Power Management Setup

☞ **ACPI Suspend Type**

- ▶▶ S1(POS) Set ACPI suspend type is S1. (Default Value)
- ▶▶ S3(STR) Set ACPI suspend type is S3.

☞ **Power Management**

- ▶▶ User Define For configuring our own power management features. (Default Value)
- ▶▶ Min Saving Enable Green function.
- ▶▶ Man Saving Disable Green function.

☞ **Video off Method**

- ▶▶ V/H SYNC+Blank BIOS will turn off V/H-SYNC when gets into Green mode for Green monitor power saving.
- ▶▶ Blank Screen BIOS will only black monitor when gets into Green mode.
- ▶▶ DPMS BIOS will use DPMS Standard to control VGA card. (The Green type VGA card will turn off V/H-SYNC automatically.) (Default value)

☞ **Video Off In Suspend**

- ▶▶ Yes Set Suspend type is stop grant. (Default value)
- ▶▶ No SuspendSet Suspend type is Power on Suspend.

☞ **Suspend Type**

- ▶▶ Stop Grant Set Suspend type is stop grant. (Default value)
- ▶▶ PwrOn Suspend Set Suspend type is Power on Suspend.

☞ **MODEM Use IRQ**

- ▶▶ NA Set MODEM Use IRQ to NA.(Default Value)
- ▶▶ 3 Set MODEM Use IRQ to 3.
- ▶▶ 4 Set MODEM Use IRQ to 4.
- ▶▶ 5 Set MODEM Use IRQ to 5.
- ▶▶ 7 Set MODEM Use IRQ to 7.
- ▶▶ 9 Set MODEM Use IRQ to 9.
- ▶▶ 10 Set MODEM Use IRQ to 10.
- ▶▶ 11 Set MODEM Use IRQ to 11.

☞ Suspend Mode

- ▶▶ Disabled Disabled Suspend Mode. (Default Value)
- ▶▶ 1 min - 1 Hour Setup the timer to enter Suspend Mode.

☞ HDD Power Down

- ▶▶ Disabled Disabled HDD Power Down mode function. (Default Value)
- ▶▶ 1-15 mins. Enabled HDD Power Down mode between 1 to 15 mins.

☞ Soft-off by Power Button

- ▶▶ Instant off Soft switch ON/OFF for Power Button. (Default Value)
- ▶▶ Delay-4Sec Soft switch ON 4 Sec for Power off.

☞ PME Event Wake UP

- ▶▶ Disabled Disabled this function.
- ▶▶ Enabled Enabled PME Event Wake up. (Default Value)

☞ Modem Ring On/Wake On LAN

- ▶▶ Disabled Disabled Modem Ring on/wake on Lan function.
- ▶▶ Enabled Enabled Modem Ring on/wake on Lan. (Default Value)

☞ USB Device Wake-Up from S3

- ▶▶ Disabled Disabled USB Device Wake-Up from S3. (Default Value)
- ▶▶ Enabled Enabled USB Device Wake-Up from S3.

☞ CPU Thermal-Throttling

- ▶▶ 50.0% Monitor CPU Temp. will cause system slow down CPU Duty Cycle to 50.0%. (Default Value)
- ▶▶ 37.5% Monitor CPU Temp. will cause system slow down CPU Duty Cycle to 37.5%.
- ▶▶ 25.0% Monitor CPU Temp. will cause system slow down CPU Duty Cycle to 25.0%.
- ▶▶ 12.5% Monitor CPU Temp. will cause system slow down CPU Duty Cycle to 12.5%.
- ▶▶ 87.5% Monitor CPU Temp. will cause system slow down CPU Duty Cycle to 87.5%.
- ▶▶ 75.0% Monitor CPU Temp. will cause system slow down CPU Duty Cycle to 75.0%.
- ▶▶ 62.5% Monitor CPU Temp. will cause system slow down CPU Duty Cycle to 62.5%.

☞ **RTC Alarm by Resume**

You can set "RTC Alarm Resume" item to enabled and key in Data/time to power on system.

- ▶▶ Disabled Disable this function. (Default Value)
- ▶▶ Enabled Enable alarm function to POWER ON system.

If RTC Alarm Lead To Power On is Enabled.

RTC Alarm Date : Every Day,1~31

RTC Alarm Hour: 0~23

RTC Alarm Minute : 0~59

RTC Alarm Second : 0~59

☞ **Primary/Secondary IDE 0/1**

- ▶▶ Disabled Disabled this function. (Default value)
- ▶▶ Enabled Enabled monitor Primary/Secondary IDE 0/1 for Green event.

☞ **FDD,COM,LPT Port**

- ▶▶ Disabled Disabled this function. (Default value)
- ▶▶ Enabled Enabled monitor FDC,COM,LPT for Green event.

☞ **PCI PIRQ[A-D] #**

- ▶▶ Enabled Monitor PCI PIRQ[A-D]# IRQ Active.
- ▶▶ Disabled Ignore PCI PIRQ[A-D]# IRQ Active. (Default value)

PNP/PCI Configuration

CMOS Setup Utility-Copyright (C) 1984-2001 Award Software

PnP/PCI Configurations

PNP OS Installed	No	Item Help
		Menu Level
Resources Controlled By	Auto	
×IRQ Resources	Press Enter	
PCI1 IRQ Assignment	Auto	
PCI2 IRQ Assignment	Auto	
PCI3 IRQ Assignment	Auto	
↑↓→←: Move Enter:Select +/-/PU/PD:Value F10:Save ESC:Exit F1:General Help F5:Previous Values F6:Fail-Safe Defaults F7:Optimized Defaults		

Figure 7: PnP/PCI Configurations

☞ PNP OS Install

- ▶▶ No Disable this function. (Default Value)
- ▶▶ Yes Enabled PNP OS install.

☞ Reset Configuration Data

Advising BIOS clear PnP configuration data for usable value.

- ▶▶ Disabled Disable this function. (Default Value)
- ▶▶ Enabled Reset PnP configuration data in order to re-initialize ESCD for PnP device.

☞ PCI Slot1, 2, 3 IRQ Priority

- ▶▶ Auto The system will reserved a free IRQ for PCI slot 1, 2, 3, device. (Default Value)
- ▶▶ 3 The system will reserved IRQ3 for PCI slot 1, 2, 3 device if no legacy ISA device using IRQ3.
- ▶▶ 4 The system will reserved IRQ for PCI slot 1, 2, 3 device if no legacy ISA device using IRQ4.
- ▶▶ 5 The system will reserved IRQ5 for PCI slot 1, 2, 3 device if no legacy ISA device using IRQ5.
- ▶▶ 7 The system will reserved IRQ7 for PCI slot 1, 2, 3 device if no legacy ISA device using IRQ7.

- ▶▶9 The system will reserved IRQ9 for PCI slot 1, 2, 3 device if no legacy ISA device using IRQ9.
- ▶▶10 The system will reserved IRQ10 for PCI slot 1, 2, 3 device if no legacy ISA device using IRQ10.
- ▶▶11 The system will reserved IRQ11 for PCI slot 1, 2, 3 device if no legacy ISA device using IRQ11.

PC Health Status

CMOS Setup Utility-Copyright (C) 1984-2001 Award Software

PC Health Status

VCORE	1.792 V	Item Help
+3.3V	3.360V	Menu Level
+ 5V	5.053 V	
+12V	12.096V	
Current CPU Temperature	43°C/109°F	
Current CPU FAN Speed	5443 RPM	
Current POWER FAN Speed	0 RPM	
Current SYSTEM FAN speed	0 RPM	
CPU Warning Temperature	Disabled	
CPU FAN Fail Warning	Disabled	
POWER FAN Fail Warning	Disabled	
SYSTEM FAN Fail Warning	Disabled	
↑↓ → ← : Move Enter:Select +/-/PU/PD:Value F10:Save ESC:Exit F1:General Help F5:Previous Values F6:Fail-Safe Defaults F7:Optimized Defaults		

Figure8: PC Health Status

Current Voltage (V) VCORE / +3.3V / +5V / +12V

▶▶ Detect system's voltage status automatically.

Current CPU Temperature (°C / °F)

▶▶ Detect CPU Temp. automatically.

Current CPU FAN / POWER FAN / SYSTEM FAN Speed (RPM)

▶▶ Detect Fan speed status automatically.

☞ **CPU Warning Temperature**

- ▶▶ 60°C / 140°F Monitor CPU Temp. at 60°C / 140°F.
- ▶▶ 70°C / 158°F Monitor CPU Temp. at 70°C / 158°F.
- ▶▶ 80°C / 176°F Monitor CPU Temp. at 80°C / 176°F.
- ▶▶ 90°C / 194°F Monitor CPU Temp. at 90°C / 194°F.
- ▶▶ Disabled Disabled this function.(Default value)

☞ **Fan Fail Warning (CPU / POWER / SYSTEM)**

- ▶▶ Disabled Fan Fail Alarm Function Disabled. (Default value)
- ▶▶ Enabled Fan Fail Alarm Function Enabled.

Frequency/Voltage Control

CMOS Setup Utility-Copyright (C) 1984-2001 Award Software
 Frequency/Voltage Control

CPU Clock Ratio	Default	Item Help
		Menu Level
↑↓→←: Move Enter:Select +/-PU/PD:Value F10:Save ESC:Exit F1:General Help F5:Previous Values F6:Fail-Safe Defaults F7:Optimized Defaults		

Figure 9: Frequency/Voltage Control

CPU Clock Ratio

▶▶Default It's depends on CPU Clock Ratio.

Load Fail-Safe Defaults

CMOS Setup Utility-Copyright (C) 1984-2001 Award Software

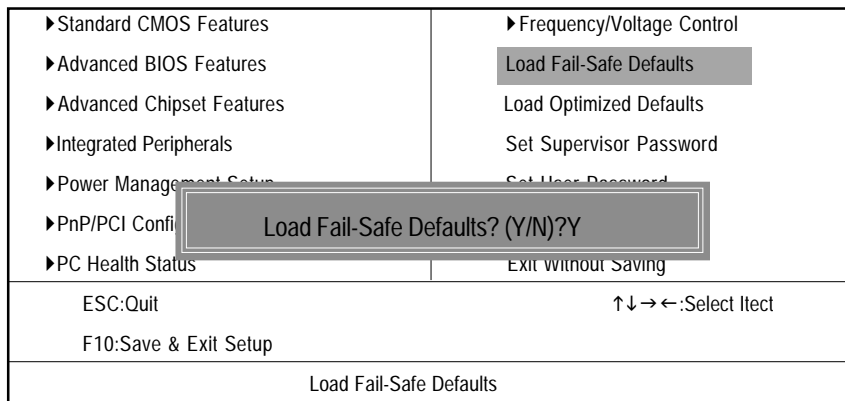

Figure 10: Load Fail-Safe Defaults

Load Fail-Safe Defaults

Fail-Safe defaults contain the most appropriate values of the system parameters that allow minimum system performance.

Load Optimized Defaults

CMOS Setup Utility-Copyright (C) 1984-2001 Award Software

▶Standard CMOS Features	▶Frequency/Voltage Control
▶Advanced BIOS Features	Load Fail-Safe Defaults
▶Advanced Chipset Features	Load Optimized Defaults
▶Integrated Peripherals	Set Supervisor Password
▶Power Management Setup	Set User Password
▶PnP/PCI Config	Load Optimized Defaults? (Y/N)?Y
▶PC Health Statu	
ESC:Quit	↑↓→←:Select Item
F10:Save & Exit Setup	
Load Optimized Defaults	

Figure 11: Load Optimized Defaults

Load Optimized Defaults

Selecting this field loads the factory defaults for BIOS and Chipset Features which the system automatically detects.

Set Supervisor/User Password

CMOS Setup Utility-Copyright (C) 1984-2001 Award Software

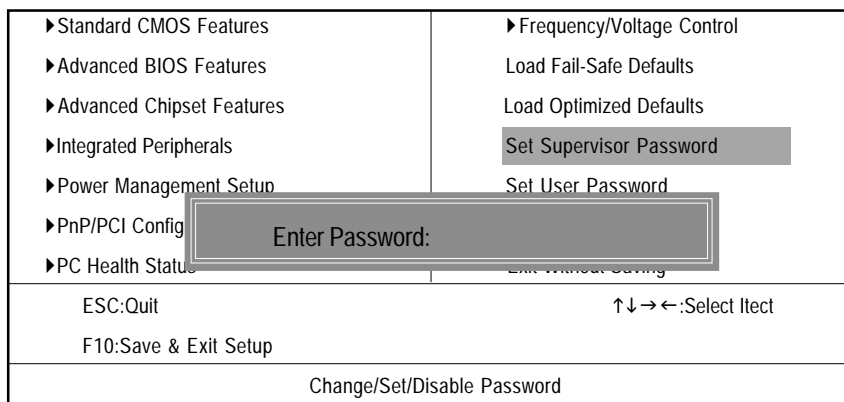

Figure 12: Password Setting

When you select this function, the following message will appear at the center of the screen to assist you in creating a password.

Type the password, up to eight characters, and press <Enter>. You will be asked to confirm the password. Type the password again and press <Enter>. You may also press <Esc> to abort the selection and not enter a password.

To disable password, just press <Enter> when you are prompted to enter password. A message "PASSWORD DISABLED" will appear to confirm the password being disabled. Once the password is disabled, the system will boot and you can enter Setup freely.

The BIOS Setup program allows you to specify two separate passwords: a SUPERVISOR PASSWORD and a USER PASSWORD. When disabled, anyone may access all BIOS Setup program function. When enabled, the Supervisor password is required for entering the BIOS Setup program and having full configuration fields, the User password is required to access only basic items.

If you select "System" at "Security Option" in Advance BIOS Features Menu, you will be prompted for the password every time the system is rebooted or any time you try to enter Setup Menu.

If you select "Setup" at "Security Option" in Advance BIOS Features Menu, you will be prompted only when you try to enter Setup.

Save & Exit Setup

CMOS Setup Utility-Copyright (C) 1984-2001 Award Software

▶Standard CMOS Features	▶Frequency/Voltage Control
▶Advanced BIOS Features	Load Fail-Safe Defaults
▶Advanced Chipset Features	Load Optimized Defaults
▶Integrated Peripherals	Set Supervisor Password
▶Power Management Setup	Set User Password
▶PnP/PCI Confir	Exit without Saving
▶PC Health Status	
Save to CMOS and EXIT (Y/N)? Y	
ESC:Quit	↑↓→←:Select Item
F10:Save & Exit Setup	
Save Data to CMOS	

Figure 13: Save & Exit Setup

Type "Y" will quit the Setup Utility and save the user setup value to RTC CMOS.

Type "N" will return to Setup Utility.

Exit Without Saving

CMOS Setup Utility-Copyright (C) 1984-2001 Award Software

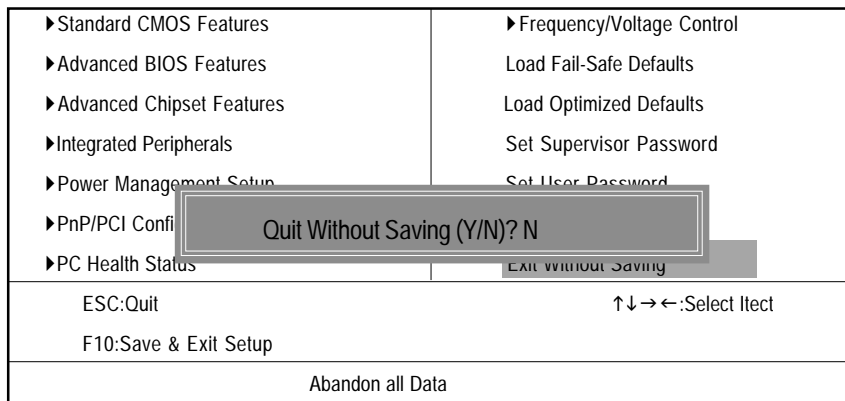

Figure 14: Exit Without Saving

Type "Y" will quit the Setup Utility without saving to RTC CMOS.

Type "N" will return to Setup Utility.

Chapter 4 Technical Reference

Block Diagram

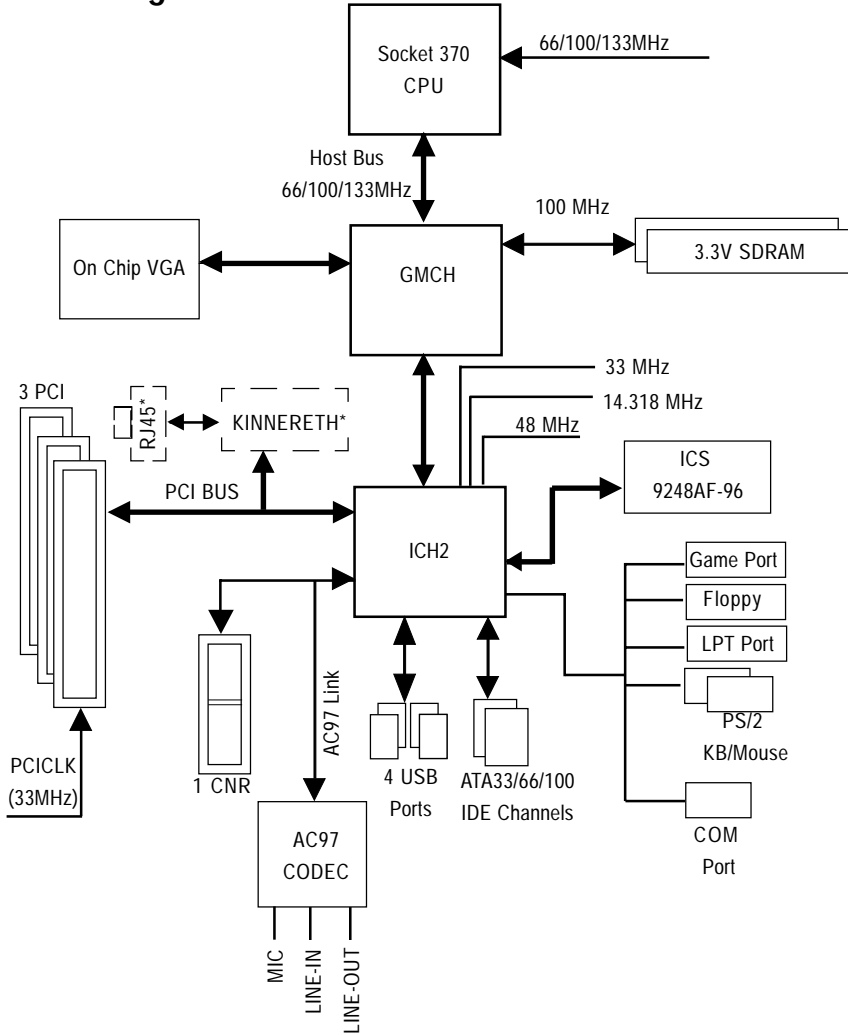

*** Only for GA-6IWFL.

@ BIOS Introduction

Gigabyte announces @ BIOS

Windows BIOS live update utility



Have you ever updated BIOS by yourself? Or like many other people, you just know what BIOS is, but always hesitate to update it? Because you think updating newest BIOS is unnecessary and actually you don't know how to update it.

Maybe not like others, you are very experienced in BIOS updating and spend quite a lot of time to do it. But of course you don't like to do it too much. First, download different BIOS from website and then switch the operating system to DOS mode. Secondly, use different flash utility to update BIOS. The above process is not a interesting job. Besides, always be carefully to store the BIOS source code correctly in your disks as if you update the wrong BIOS, it will be a nightmare.

Certainly, you wonder why motherboard vendors could not just do something right to save your time and effort and save you from the lousy BIOS updating work? Here it comes! Now Gigabyte announces @BIOS—the first Windows BIOS live update utility. This is a smart BIOS update software. It could help you to download the BIOS from internet and update it. Not like the other BIOS update software, it's a Windows utility. With the help of "@BIOS", BIOS updating is no more than a click.

Besides, no matter which mainboard you are using, if it's a Gigabyte's product*, @BIOS help you to maintain the BIOS. This utility could detect your correct mainboard model and help you to choose the BIOS accordingly. It then downloads the BIOS from the nearest Gigabyte ftp site automatically. There are several different choices; you could use "Internet Update" to download and update your BIOS directly. Or you may want to keep a backup for your current BIOS, just choose "Save Current BIOS" to save it first. You make a wise choice to use Gigabyte, and @BIOS update your BIOS smartly. You are now worry free from updating wrong BIOS, and capable to maintain and manage your BIOS easily. Again, Gigabyte's innovative product erects a milestone in mainboard industries.

For such a wonderful software, how much it costs? Impossible! It's free! Now, if you buy a Gigabyte's motherboard, you could find this amazing software in the attached driver CD. But please remember, connected to internet at first, then you could have a internet BIOS update from your Gigabyte @BIOS.

Easy TuneIII™ Introduction

Gigabyte announces *EasyTuneIII* Windows overdrive utility



“Overdrive” might be one of the most common issues in computer field. But have many users ever tried it? The answer is probably “no”. Because “overdrive” is thought to be very difficult and includes a lot of technical know-how, sometimes “over-

drive” is even considered as special skills found only in some enthusiasts.

But as to the experts in “overdrive”, what’s the truth? They may spend quite a lot of time and money to study, try and use many different hardware and software tools to do “overdrive”. And even with these technologies, they still learn that it’s quite a risk because the safety and stability of an “overdrive” system is unknown.

Now everything is different because of a Windows overdrive utility EasyTuneIII—announced by Gigabyte. This utility has totally changed the gaming rule of “overdrive”. This is the first overdrive utility suitable for both normal and power users. Users can choose either “Easy Mode” or “Advanced Mode” to run “overdrive” at their convenience. For users who choose “Easy Mode”, they just need to click “Auto Optimize” to have auto and immediate CPU overclocking. This software will then overdrive CPU speed automatically with the result being shown in the control panel. If someone prefers to “overdrive” by oneself, there is also another choice. Click “Advanced Mode” to enjoy “sport drive” class overclocking. In “Advanced Mode”, one can change the system bus speed in small increments to get ultimate system performance. And no matter which mainboard is used, if it’s a Gigabyte’s product”, EasyTuneIII helps to perform the best of system.

Besides, different from other traditional over-clocking methods, EasyTuneIII doesn’t require users to change neither BIOS nor hardware switch/jumper setting; on the other hand, they can do “overdrive” at only one click. Therefore, this is a safer way for “overdrive” as nothing is changed on software or hardware. If user runs EasyTuneIII over system’s limitation, the biggest lost is only to restart the computer again and the side effect is then well controlled. Moreover, if one well-performed system speed been tested in EasyTuneIII, user can “Save” this bus speed and “Load” it in next time. Obviously, Gigabyte EasyTuneIII has already turned the “overdrive” technology toward to a newer generation.

This wonderful software is now free bundled in Gigabyte motherboard attached driver CD. Users may make a test drive of “EasyTuneIII” to find out more amazing features by themselves.

Chapter 5 Appendix

Picture below are shown in Windows ME (IUCD driver version 1.9)

Appendix A: Intel 810 Chipset Driver Installation

A. Windows 9x/ME/2000/XP INF Update Utility:

Insert the driver CD-title that came with your motherboard into your CD-ROM driver, the driver CD-title will auto start and show the installation guide. If not, please double click the CD-ROM device icon in "My computer", and execute the setup.exe.



(1)

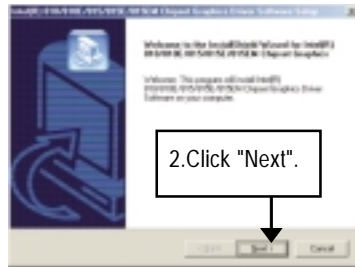

(2)

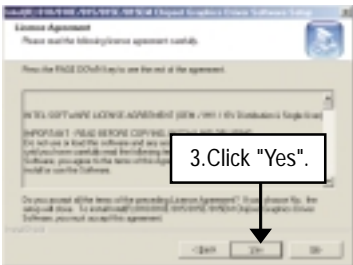

(3)

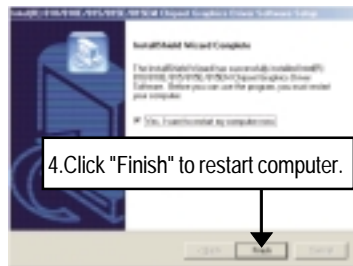

(4)

B. Intel Ultra ATA Storage Driver:

Insert the driver CD-title that came with your motherboard into your CD-ROM driver, the driver CD-title will auto start and show the installation guide. If not, please double click the CD-ROM device icon in "My computer", and execute the setup.exe.



(1)

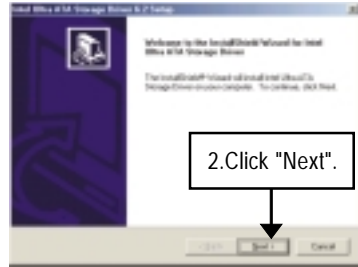

(2)

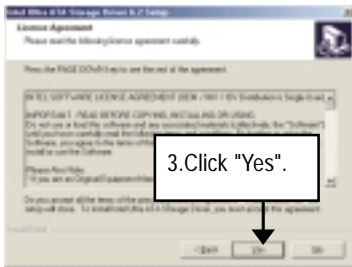

(3)

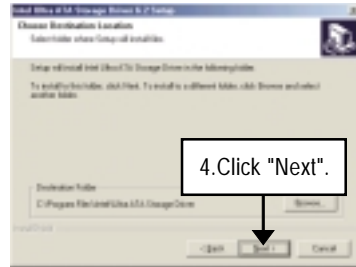

(4)

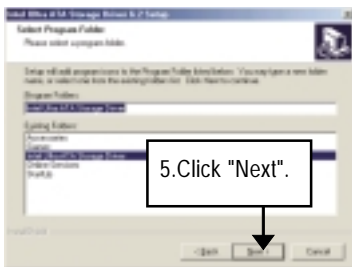

(5)

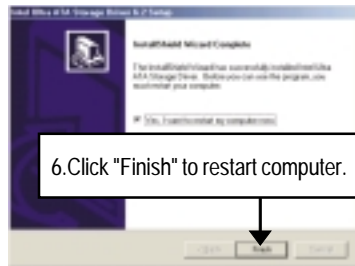

(6)

Appendix B: RealTek AC'97 Audio Driver

Insert the driver CD-title that came with your motherboard into your CD-ROM driver, the driver CD-title will auto start and show the installation guide. If not, please double click the CD-ROM device icon in "My computer", and execute the setup.exe.



(1)

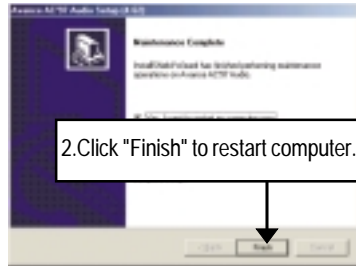

(2)

Appendix C: Intel 82562 Network Driver

Insert the driver CD-title that came with your motherboard into your CD-ROM driver, the driver CD-title will auto start and show the installation guide. If not, please double click the CD-ROM device icon in "My computer", and execute the setup.exe.

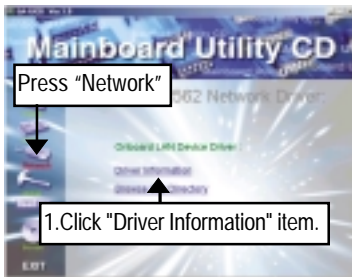

(3)

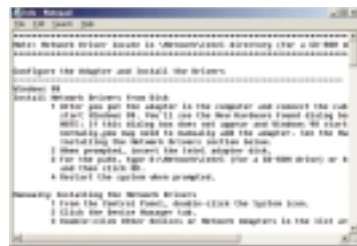

(4)

Appendix D: EasyTuneIII Utilities Installation

Insert the driver CD-title that came with your motherboard into your CD-ROM driver, the driver CD-title will auto start and show the installation guide. If not, please double click the CD-ROM device icon in "My computer", and execute the setup.exe.

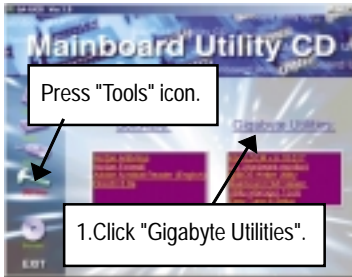

(1)

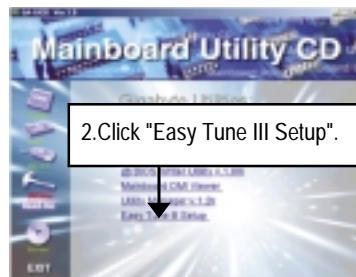

(2)

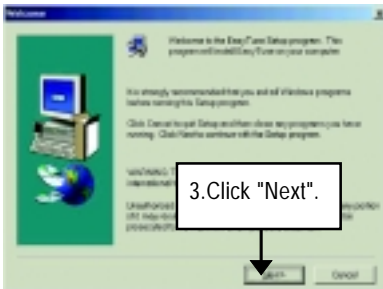
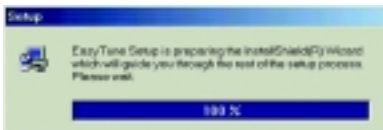

(3)

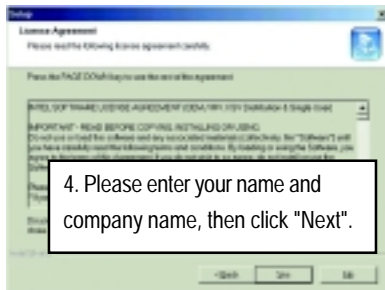

(4)

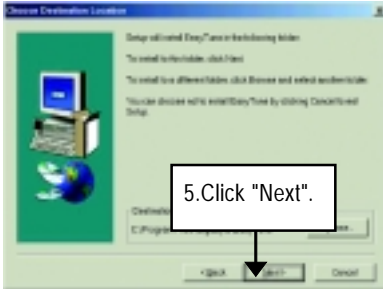

(5)

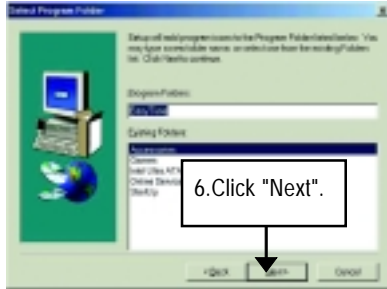

(6)

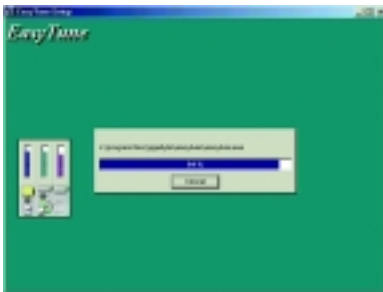

(7)

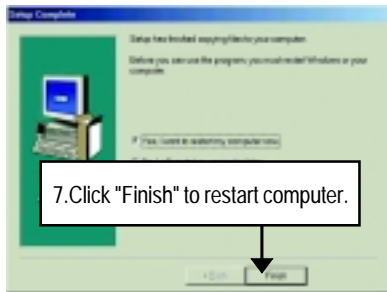

(8)

Appendix E: Issues To Beware Of When Installing CNR

Please use standard CNR card like the one in order to avoid mechanical problem. (See Figure A)

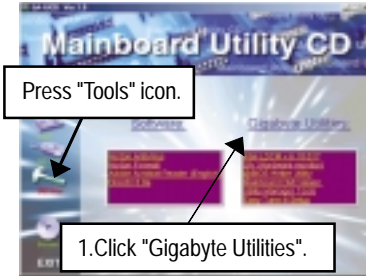

Figure A: Standard CNR Card

Appendix F: BIOS Flash Procedure

BIOS update procedure:

If your OS is Win9X, we recommend that you used Gigabyte @BIOS™ Program to flash BIOS.



(1)

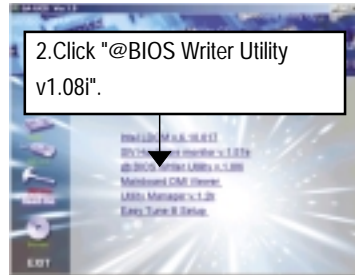

(2)

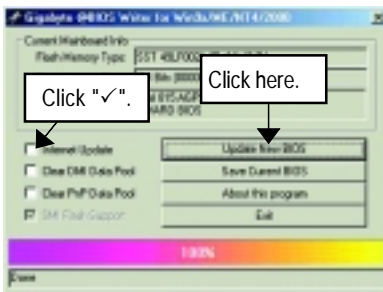

(3)

Methods and steps:

- I. Update BIOS through Internet
 - a. Click "Internet Update" icon
 - b. Click "Update New BIOS" icon
 - c. Select @BIOS™ sever ("Gigabyte @BIOSTM sever 1 in Taiwan" and "Gigabyte @BIOS™ sever 2 in Taiwan" are available for now, the others will be completed soon)
 - d. Select the exact model name on your motherboard
 - e. System will automatically download and update the BIOS.

II. Update BIOS NOT through Internet:

- a. Do not click "Internet Update" icon
- b. Click "Update New BIOS"
- c. Please select "All Files" in dialog box while opening the old file.
- d. Please search for BIOS unzip file, downloading from internet or any other methods (such as: 8ITXE.F1).
- e. Complete update process following the instruction.

III. Save BIOS

In the very beginning, there is "Save Current BIOS" icon shown in dialog box. It means to save the current BIOS version.

IV. Check out supported motherboard and Flash ROM:

In the very beginning, there is "About this program" icon shown in dialog box. It can help you check out which kind of motherboard and which brand of Flash ROM are supported.

Note:

- a. In method I, if it shows two or more motherboard's model names to be selected, please make sure your motherboard's model name again. Selecting wrong model name will cause the system unbooted.
- b. In method II, be sure that motherboard's model name in BIOS unzip file are the same as your motherboard's. Otherwise, your system won't boot.
- c. In method I, if the BIOS file you need cannot be found in @BIOS™ server, please go onto Gigabyte's web site for downloading and updating it according to method II.
- d. Please note that any interruption during updating will cause system unbooted

We use GA-7VTX motherboard and Flash841 BIOS flash utility as example.

Please flash the BIOS according to the following procedures if you are now under the DOS mode.

Flash BIOS Procedure:

STEP 1:

- (1) Please make sure you have set "Auto" for BIOS Feature Setup (BIOS Flash Protection). For more detail please refer to page 32.
- (2) Please make sure your system has installed the extraction utility such as winzip or pkunzip.
Firstly you have to install the extraction utility such as winzip or pkunzip for unzip the files. Both of these utilities are available on many shareware download pages like <http://www.shareware.cnet.com>

STEP 2: Make a DOS boot diskette. (See example: Windows 98 O.S.)

Beware: Windows ME/2000 are not allowed to make a DOS boot diskette.

- (1) With an available floppy disk in the floppy drive. Please leave the diskette "UN-write protected" type. Double click the "My Computer" icon from Desktop, then click "3.5 diskette (A)" and right click to select "Format (M)"

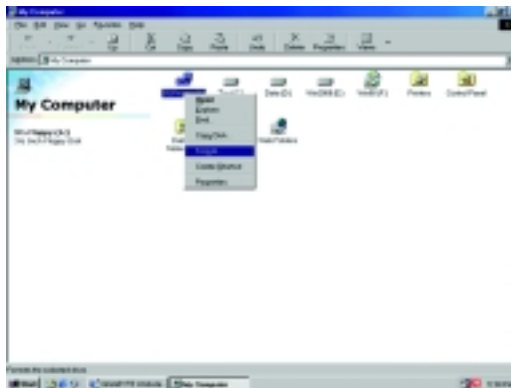

- (2) Select the "Quick (erase)" for Format Type, and pick both "Display summary when finished" and "Copy system files", after that press "Start". That will format the floppy and transfer the needed system files to it.

Beware: This procedure will erase all the prior data on that floppy, so please proceed accordingly.

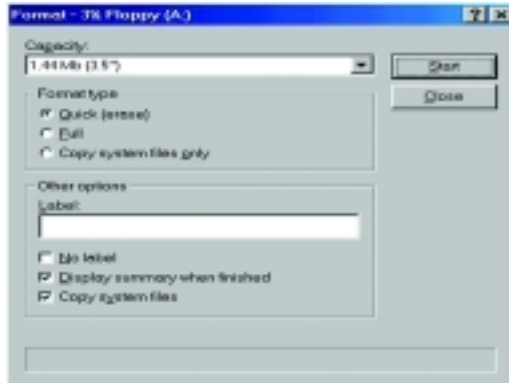

- (3) After the floppy has been formatted completely, please press "Close".



STEP 3: Download BIOS and BIOS utility program.

(1) Please go to Gigabyte website <http://www.gigabyte.com.tw/index.html>, and click "Support".



(2) From Support zone, click the "Motherboards BIOS & Drivers".

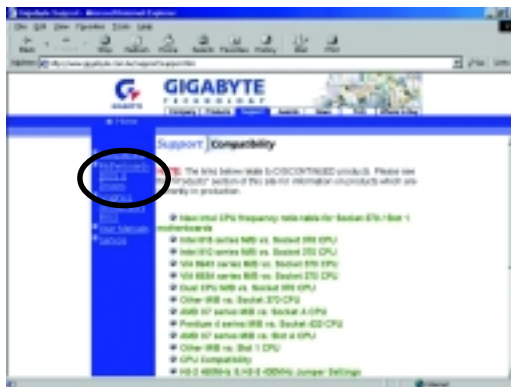

- (3) We use GA-7VTX motherboard as example. Please select GA-7VTX by Model or Chipset optional menu to obtain BIOS flash files.

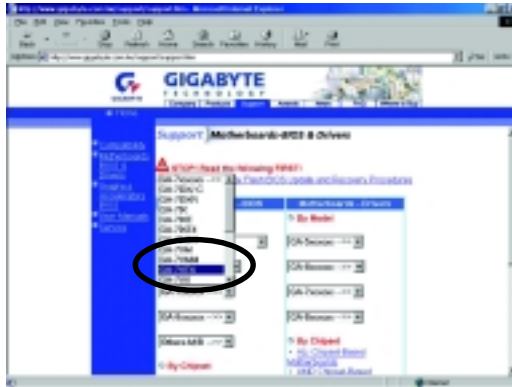

- (4) Select an appropriate BIOS version (For example: F4), and click to download the file. It will pop up a file download screen, then select the "Open this file from its current location" and press "OK".

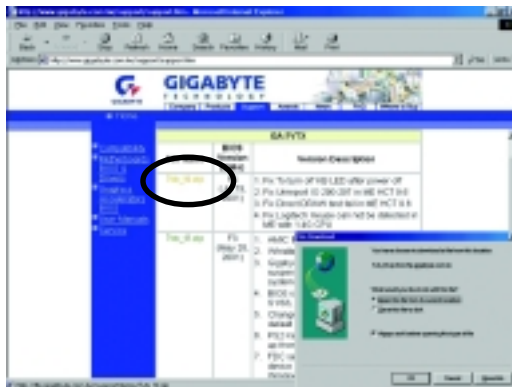

- (5) At this time the screen shows the following picture, please click "Extract" button to unzip the files.

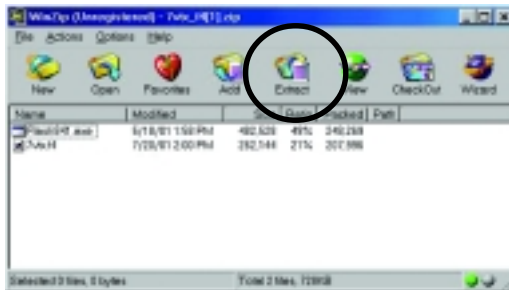

- (6) Please extract the download files into the clean bootable floppy disk A mentioned in STEP 2, and press "Extract".

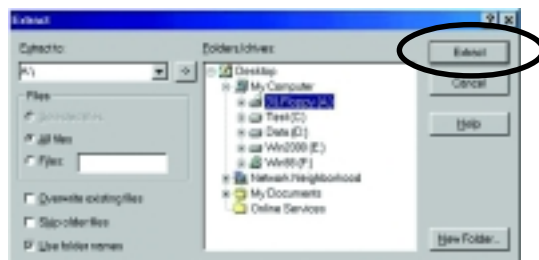

STEP 4: Make sure the system will boot from the floppy disk.

- (1) Insert the floppy disk (contains bootable program and unzip file) into the floppy drive A. Then, restart the system. The system will boot from the floppy disk. Please press key to enter BIOS setup main menu when system is boot up.



- (2) Once you enter the BIOS setup utility, the main menu will appear on the screen. Use the arrows to highlight the item "BIOS FEATURES SETUP".

AMIBIOS SIMPLE SETUP UTILITY - VERSION 1.24b (C) 1999 American Megatrends, Inc. All Rights Reserved	
STANDARD CMOS SETUP BIOS FEATURES SETUP CHIPSET FEATURES SETUP POWER MANAGEMENT SETUP PNP / PCI CONFIGURATION LOAD BIOS DEFAULTS LOAD SETUP DEFAULTS	INTEGRATED PERIPHERALS HARDWARE MONITOR & MISC SETUP SUPERVISOR PASSWORD USER PASSWORD IDE HDD AUTO DETECTION SAVE & EXIT SETUP EXIT WITHOUT SAVING
ESC: Quit ↑↓←→ : Select Item (Shift)F2 : Change Color F5: Old Values F6: Load BIOS Defaults F7: Load Setup Defaults F10: Save & Exit	
Time, Date , Hard Disk Type...	

- (3) Press "Enter" to enter "BIOS FEATURES SETUP" menu. Use the arrows to highlight the item "1st Boot Device", and then use the "Page Up" or "Page Down" keys to select "Floppy".

AMIBIOS SETUP - BIOS FEATURES SETUP	
(C) 2001 American Megatrends, Inc. All Rights Reserved	
1st Boot Device : Floppy	
2nd Boot Device : IDE-0	
3rd Boot Device : CDROM	
S.M.A.R.T. for Hard Disks : Disabled	
BootUp Num-Lock : On	ESC: Quit ↑↓←→: Select Item
Floppy Drive Seek : Disabled	F1 : Help PU/PD/+/- : Modify
Password Check : Setup	F5 : Old Values (Shift)F2: Color
	F6 : Load BIOS Defaults
	F7 : Load Setup Defaults

- (4) Press "ESC" to go back to previous screen. Use the arrows to highlight the item "SAVE & EXIT SETUP" then press "Enter". System will ask "SAVE to CMOS and EXIT (Y/N)?" Press "Y" and "Enter" keys to confirm. Now the system will reboot automatically, the new BIOS setting will be taken effect next boot-up.

AMIBIOS SIMPLE SETUP UTILITY - VERSION 1.24b	
(C) 2001 American Megatrends, Inc. All Rights Reserved	
STANDARD CMOS SETUP	INTEGRATED PERIPHERALS
BIOS FEATURES SETUP	HARDWARE MONITOR & MISC SETUP
CHIPSET FEATURES SETUP	SUPERVISOR PASSWORD
POWER MANAGEMENT SETUP	USER PASSWORD
PNP / PCI CONF	Save to CMOS and EXIT (Y/N)? Y
LOAD BIOS DEFAULTS	SAVE & EXIT SETUP
LOAD SETUP DEFAULTS	EXIT WITHOUT SAVING
ESC: Quit ↑↓←→ : Select Item (Shift)F2 : Change Color F5: Old Values	
F6: Load BIOS Defaults F7: Load Setup Defaults F10: Save & Exit	
Save Data to CMOS & Exit SETUP	

STEP 5: BIOS flashing.

- (1) After the system boot from floppy disk, type "A:\> dir/w" and press "Enter" to check the entire files in floppy A. Then type the "BIOS flash utility" and "BIOS file" after A:\>. In this case you have to type "A:\> Flash841 7VTX.F4" and then press "Enter".

```
Starting Windows 98...

Microsoft(R) Windows98
  © Copyright Microsoft Corp 1981-1999

A:\> dir/w
  Volume in drive A has no label
  Volume Serial Number is 16EB-353D
  Directory of A:\
COMMAND.COM      7VTX.F4  FLASH841.EXE
      3 file(s)    838,954 bytes
      0 dir(s)    324,608 bytes free

A:\> Flash841 7VTX.F4
```

- (2) Now screen appears the following Flash Utility main menu. Press "Enter", the highlighted item will locate on the model name of the right-upper screen. Right after that, press "Enter" to start BIOS Flash Utility.

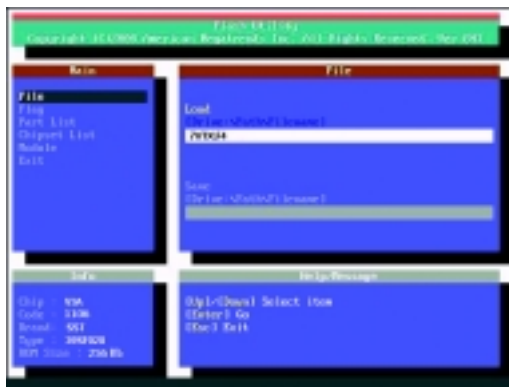

- (3) It will pop up a screen and asks "Are you sure to flash the BIOS?" Press [Enter] to continue the procedure, or press [ESC] to quit.

Beware: Please do not turn off the system while you are upgrading BIOS. It will render your BIOS corrupted and system totally inoperative.

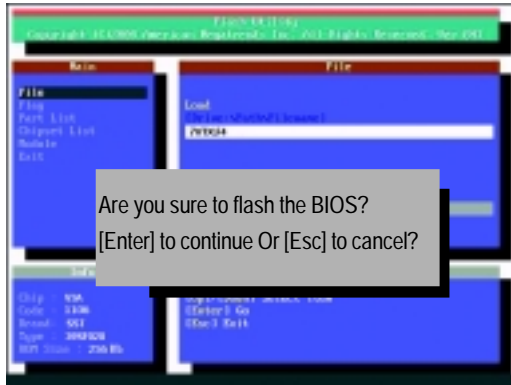

- (4) The BIOS flash completed. Please press [ESC] to exit Flash Utility.

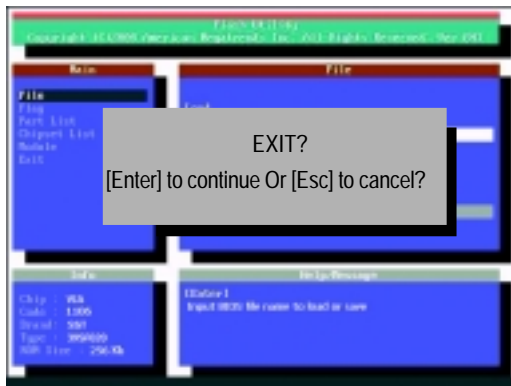

STEP 6: Load BIOS defaults.

Normally the system redetects all devices after BIOS has been upgraded. Therefore, we highly recommend reloading the BIOS defaults after BIOS has been upgraded. This important step resets everything after the flash.

- (1) Take out the floppy diskette from floppy drive, and then restart the system. The boot up screen will indicate your motherboard model and current BIOS version.



- (2) Don't forget to press key to enter BIOS setup again when system is boot up. Use the arrows to highlight the item "LOAD SETUP DEFAULTS" then press "Enter". System will ask "Load Setup Defaults (Y/N)?" Press "Y" and "Enter" keys to confirm.

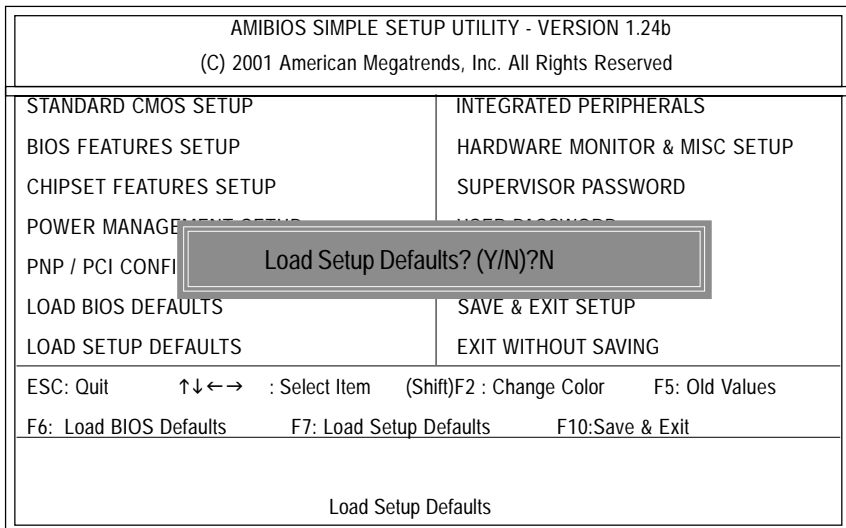

- (3) Use the arrows to highlight the item "SAVE & EXIT SETUP" and press "Enter". System will ask "SAVE to CMOS and EXIT (Y/N)?" Press "Y" and "Enter" keys to confirm. Now the system will reboot automatically, the new BIOS setting will be taken effect next boot-up.

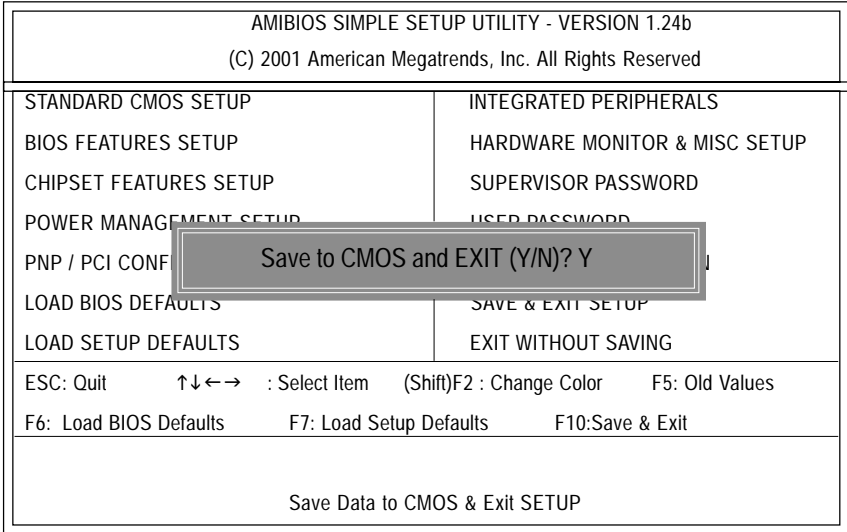

- (4) Congratulate you have accomplished the BIOS flash procedure.

Appendix G: Acronyms

Acronyms	Meaning
ACPI	Advanced Configuration and Power Interface
APM	Advanced Power Management
AGP	Accelerated Graphics Port
AMR	Audio Modem Riser
ACR	Advanced Communications Riser
BBS	BIOS Boot Specification
BIOS	Basic Input / Output System
CPU	Central Processing Unit
CMOS	Complementary Metal Oxide Semiconductor
CRIMM	Continuity RIMM
CNR	Communication and Networking Riser
DMA	Direct Memory Access
DMI	Desktop Management Interface
DIMM	Dual Inline Memory Module
DRM	Dual Retention Mechanism
DRAM	Dynamic Random Access Memory
DDR	Double Data Rate
ECP	Extended Capabilities Port
ESCD	Extended System Configuration Data
ECC	Error Checking and Correcting
EMC	Electromagnetic Compatibility
EPP	Enhanced Parallel Port
ESD	Electrostatic Discharge
FDD	Floppy Disk Device
FSB	Front Side Bus
HDD	Hard Disk Device
IDE	Integrated Dual Channel Enhanced
IRQ	Interrupt Request
I/O	Input / Output
IOAPIC	Input Output Advanced Programmable Input Controller
ISA	Industry Standard Architecture

to be continued.....

GA-6IWF Series Motherboard

Acronyms	Meaning
LAN	Local Area Network
LBA	Logical Block Addressing
LED	Light Emitting Diode
MHz	Megahertz
MIDI	Musical Interface Digital Interface
MTH	Memory Translator Hub
MPT	Memory Protocol Translator
NIC	Network Interface Card
OS	Operating System
OEM	Original Equipment Manufacturer
PAC	PCI A.G.P. Controller
POST	Power-On Self Test
PCI	Peripheral Component Interconnect
RIMM	Rambus in-line Memory Module
SCI	Special Circumstance Instructions
SECC	Single Edge Contact Cartridge
SRAM	Static Random Access Memory
SMP	Symmetric Multi-Processing
SMI	System Management Interrupt
USB	Universal Serial Bus
VID	Voltage ID

 **Technical Support/RMA Sheet**

Customer/Country:	Company:	Phone No.:
Contact Person:	E-mail Add. :	

Model name/Lot Number:	PCB revision:
BIOS version:	O.S./A.S.:

Hardware Configuration	Mfs.	Model name	Size:	Driver/Utility:
CPU				
Memory				
Brand				
Video Card				
Audio Card				
HDD				
CD-ROM / DVD-ROM				
Modem				
Network				
AMR / CNR				
Keyboard				
Mouse				
Power supply				
Other Device				

Problem Description:



DECLARATION OF CONFORMITY

Per FCC Part 2 Section 2.1077(a)



Responsible Party Name: G.B.T.INC.

**Address: 18305 Valley Blvd., Suite#A LA
Puent, CA 91744**

Phone/FaxNo: (818) 854-9338/ (818) 854-9339

hereby declares that the product

ProductName: Motherboard

ModelNumber: GA-6IWFE/GA-6IWFL

Conforms to the following specifications:

FCC Part 15, Subpart B, Section 15.107(a) and Section 15.109(a),
Class B Digital Device

Supplementary Information:

This device complies with part 15 of the FCC Rules. Operation is subject to the following two conditions: (1) This device may not cause harmful and (2) this device must accept any inference received, including that may cause undesired operation.

Representative Person's Name: ERIC LU

Signature: Eric Lu

Date: Oct. 31, 2001

Declaration of Conformity

We, Manufacturer/Importer
(full address)

G.B.T. Technology Trading GmbH
Ausschlagler Weg 41, 1F, 20537 Hamburg, Germany

declare that the product
(description of the apparatus, system, installation to which it refers)

Mother Board

GA-6IWFE/GA-6IWFL
is in conformity with

(reference to the specification under which conformity is declared)
in accordance with 89/336 EEC-EMC Directive

- | | | | |
|---------------------------------------------------------------------------------------------------------------|------------------------------------------------------------------------------------------------------------------------------------------------------------|--------------------------------------------------------------------------------------------------|----------------------------------------------------------------------------------------------------------------------------------------------------------------|
| <input type="checkbox"/> EN 55011 | Limits and methods of measurement of radio disturbance characteristics of industrial, scientific and medical (ISM) high frequency equipment | <input type="checkbox"/> EN 61000-3-2*
<input checked="" type="checkbox"/> EN 60555-2 | Disturbances in supply systems cause by household appliances and similar electrical equipment "Harmonics" |
| <input type="checkbox"/> EN 55013 | Limits and methods of measurement of radio disturbance characteristics of broadcast receivers and associated equipment | <input type="checkbox"/> EN 61000-3-3*
<input checked="" type="checkbox"/> EN 60555-3 | Disturbances in supply systems cause by household appliances and similar electrical equipment "Voltage fluctuations" |
| <input type="checkbox"/> EN 55014 | Limits and methods of measurement of radio disturbance characteristics of household electrical appliances, portable tools and similar electrical apparatus | <input checked="" type="checkbox"/> EN 50081-1
<input checked="" type="checkbox"/> EN 50082-1 | Generic emission standard Part 1:
Residual commercial and light industry

Generic immunity standard Part 1:
Residual commercial and light industry |
| <input type="checkbox"/> EN 55015 | Limits and methods of measurement of radio disturbance characteristics of fluorescent lamps and luminaries | <input type="checkbox"/> EN 55081-2 | Generic emission standard Part 2:
Industrial environment |
| <input type="checkbox"/> EN 55020 | Immunity from radio interference of broadcast receivers and associated equipment | <input type="checkbox"/> EN 55082-2 | Generic emission standard Part 2:
Industrial environment |
| <input checked="" type="checkbox"/> EN 55022 | Limits and methods of measurement of radio disturbance characteristics of information technology equipment | <input type="checkbox"/> ENV 55104 | Immunity requirements for household appliances tools and similar apparatus |
| <input type="checkbox"/> DIN VDE 0855
<input type="checkbox"/> part 10
<input type="checkbox"/> part 12 | Cabled distribution systems; Equipment for receiving and/or distribution from sound and television signals | <input type="checkbox"/> EN50091-2 | EMC requirements for uninterruptible power systems (UPS) |

CE marking



(EC conformity marking)

The manufacturer also declares the conformity of above mentioned product with the actual required safety standards in accordance with LVD 73/23 EEC

- | | | | |
|-----------------------------------|---------------------------------------------------------------------------------------------------------------|-------------------------------------|--|
| <input type="checkbox"/> EN 60065 | Safety requirements for mains operated electronic and related apparatus for household and similar general use | <input type="checkbox"/> EN 60950 | |
| <input type="checkbox"/> EN 60335 | Safety of household and similar electrical appliances | <input type="checkbox"/> EN 50091-1 | |

Manufacturer/Importer

(Stamp)

Date : Oct. 31, 2001

Signature: **Rex Lin**
Name: **Rex Lin**