

FCC Compliance Statement:

<p>DECLARATION OF CONFORMITY Per FCC Part 2 Section 2.1077(a)</p> <p>FCC</p> <p>Responsible Party Name: G.B.T. INC. Address: 18205 Valley Blvd., Suite#A LA Puente, CA 91744 Phone/Fax No: (818) 854-9338/ (818) 854-9339</p> <p>hereby declares that the product Product Name: Mother Board Model Number: GA-6WMZ7</p> <p>Conforms to the following specifications: FCC Part 15, Subpart B, Section 15.107(a) and Section 15.109(a), Class B Digital Device.</p> <p>Supplementary Information: This device complies with part 15 of the FCC Rules. Operation is subject to the following two conditions: (1) This device may not cause harmful and (2) this device must accept any interference received, including that may cause undesired operation.</p> <p>Representative Person's Name: <u>ERIC LY</u> Signature: <u>Eric Ly</u> Date: <u>Dec. 15, 1999</u></p>
--

This equipment has been tested and found to comply with limits for a Class B digital device , pursuant to Part 15 of the FCC rules. These limits are designed to provide reasonable protection against harmful interference in residential installations. This equipment generates, uses, and can radiate radio frequency energy, and if not installed and used in accordance with the instructions, may cause harmful interference to radio communications. However, there is no guarantee that interference will not occur in a particular installation. If this equipment does cause interference to radio or television equipment reception, which can be

determined by turning the equipment off and on, the user is encouraged to try to correct the interference by one or more of the following measures:

- Reorient or relocate the receiving antenna
- Move the equipment away from the receiver
- Plug the equipment into an outlet on a circuit different from that to which the receiver is connected
- Consult the dealer or an experienced radio/television technician for additional suggestions

You are cautioned that any change or modifications to the equipment not expressly approve by the party responsible for compliance could void Your authority to operate such equipment.

This device complies with Part 15 of the FCC Rules. Operation is subjected to the following two conditions 1) this device may not cause harmful interference and 2) this device must accept any interference received, including interference that may cause undesired operation.

Declaration of Conformity

We, Manufacturer/Importer
(full address)

G.B.T. Technology Trading GmbH
Ausschlager Weg 41, 1F, 20537 Hamburg, Germany

declare that the product
(description of the apparatus, system, installation to which it refers)

Mother Board
GA-6WMZ7

is in conformity with
(reference to the specification under which conformity is declared)
in accordance with 89/336 EEC-EMC Directive

- | | | | |
|---|--|--|--|
| <input type="checkbox"/> EN 55011 | Limits and methods of measurement of radio disturbance characteristics of industrial, scientific and medical (ISM) high frequency equipment | <input checked="" type="checkbox"/> EN 61000-3-2*
<input checked="" type="checkbox"/> EN60555-2 | Disturbances in supply systems caused by household appliances and similar electrical equipment "Harmonics" |
| <input type="checkbox"/> EN55013 | Limits and methods of measurement of radio disturbance characteristics of broadcast receivers and associated equipment | <input type="checkbox"/> EN61000-3-3*
<input checked="" type="checkbox"/> EN60555-3 | Disturbances in supply systems caused by household appliances and similar electrical equipment "Voltage fluctuations" |
| <input type="checkbox"/> EN 55014 | Limits and methods of measurement of radio disturbance characteristics of household electrical appliances, portable tools and similar electrical apparatus | <input checked="" type="checkbox"/> EN 50081-1
<input checked="" type="checkbox"/> EN 50082-1 | Generic emission standard Part 1: Residual, commercial and light industry
Generic immunity standard Part 1: Residual, commercial and light industry |
| <input type="checkbox"/> EN 55015 | Limits and methods of measurement of radio disturbance characteristics of fluorescent lamps and luminaries | <input type="checkbox"/> EN 55081-2 | Generic emission standard Part 2: Industrial environment |
| <input type="checkbox"/> EN 55020 | Immunity from radio interference of broadcast receivers and associated equipment | <input type="checkbox"/> EN 55082-2 | Generic immunity standard Part 2: Industrial environment |
| <input checked="" type="checkbox"/> EN 55022 | Limits and methods of measurement of radio disturbance characteristics of information technology equipment | <input type="checkbox"/> ENV 55104 | Immunity requirements for household appliances tools and similar apparatus |
| <input type="checkbox"/> DIN VDE 0855
<input type="checkbox"/> part 10
<input type="checkbox"/> part 12 | Cabled distribution systems; Equipment for receiving and/or distribution from sound and television signals | <input type="checkbox"/> EN 50091- 2 | EMC requirements for uninterruptible power systems (UPS) |

CE marking



(EC conformity marking)

**The manufacturer also declares the conformity of above mentioned product
with the actual required safety standards in accordance with LVD 73/23 EEC**

- | | | | |
|-----------------------------------|---|-------------------------------------|---|
| <input type="checkbox"/> EN 60065 | Safety requirements for mains operated electronic and related apparatus for household and similar general use | <input type="checkbox"/> EN 60950 | Safety for information technology equipment including electrical business equipment |
| <input type="checkbox"/> EN 60335 | Safety of household and similar electrical appliances | <input type="checkbox"/> EN 50091-1 | General and Safety requirements for uninterruptible power systems (UPS) |

Manufacturer/Importer

Signature : Rex Lin

Name : Rex Lin

(Stamp)

Date : Dec. 15, 1999

6WMZ7 Series
Intel[®] 810 Socket 370 Motherboard

USER'S MANUAL

INTEL[®] 810 Socket 370 Processor MAINBOARD

R-21-01-091207

How this manual is organized

This manual is divided into the following sections:

1) Revision List	Manual revision information
2) Item Checklist	Product item list
3) Features	Product information & specification
4) Hardware Setup	Instructions on setting up the motherboard
5) Performance & Block Diagram	Product Performance & Block Diagram
6) Suspend to RAM	Instructions STR installation
7) BIOS Setup	Instructions on setting up the BIOS software
8) Appendix	General reference

Table of Content

Revision History	P.1
Item Checklist	P.2
Summary of Features	P.3
6WMZ7 Series Motherboard Layout	P.5
Page Index for CPU Speed Setup / Connectors / Panel and Jumper Definition	P.6
Performance List	P.29
Block Diagram	P.30
Suspend to RAM Installation	P.31
Memory Installation	P.37
Page Index for BIOS Setup	P.38
Appendix	P.73

Revision History

Revision	Revision Note	Date
2.1	Initial release of the 6WMZ7 Series motherboard user's manual.	Dec.1999

The author assumes no responsibility for any errors or omissions that may appear in this document nor does the author make a commitment to update the information contained herein. Third-party brands and names are the property of their respective owners.

Item Checklist

- The 6WMZ7 Series Motherboard
- Cable for IDE / Floppy device
- Diskettes or CD (IUCD) for motherboard utilities
- Internal COM2 Cable (Optional)
- Internal USB Cable (Optional)
- Cable for SCSI device
- 6WMZ7 Series User's Manual

Summary of Features

Form factor	<ul style="list-style-type: none"> • 24.6 cm x 21.1 cm Micro ATX SIZE form factor, 4 layers PCB.
CPU	<ul style="list-style-type: none"> • Socket 370 Processor • 128 KB 2nd cache in CPU(Depend on CPU)
Chipset	<p>Intel[®] GMCH82810 ,consisting of:</p> <ul style="list-style-type: none"> • 82810/82810-DC100/82810E Graphics and memory Controller Hub(GMCH) • 82801AA I/O Controller Hub(ICH)
Clock Generator	<ul style="list-style-type: none"> • Supports 66 / 100 / 133MHz • 66 / 100 / 133MHz clocks (133MHz only GMCH82810E support)
Memory	<ul style="list-style-type: none"> • 2 168-pin DIMM Sockets • Supports PC-100 SDRAM 16MB-512MB • Supports only 3.3V SDRAM DIMM
I/O Control	<ul style="list-style-type: none"> • Winbond 83627
Slots	<ul style="list-style-type: none"> • 1 AMR • 3 32-bit Master PCI Bus slots • 1 TV/DFP • 1 16-bit ISA Bus slots (Optional)
On-Board IDE	<ul style="list-style-type: none"> • An IDE controller on the Intel[®] 82801AA (ICH) PCI chipset provides IDE HDD/ CD-ROM with PIO, Bus Master and Ultra DMA33/ATA66 operation modes • Can connect up to four IDE devices
On-Board Peripherals	<ul style="list-style-type: none"> • 1 Floppy port supports 2 FDD with 360K, 720K,1.2M, 1.44M and 2.88M bytes • 1 Parallel ports supports SPP/EPP/ECP mode • 2 Serial Ports (COMA & COMB) • 2 USB ports • 4MB Display Cache RAM (Optional for 82810-DC100/82810E) • 1 IrDA connector for IR/CIR
Hardware Monitor (Optional)	<ul style="list-style-type: none"> • CPU/Power Supply/Chassis Fan Revolution detect • CPU Fan Control • System Voltage Detect • CPU Overheat Warning • Chassis Intrusion Detect • Display Actual Current Voltage

Summary Of Features

To be continued...

On-board Sound	<ul style="list-style-type: none">• YAMAHA YMF-744 (Optional) and AC'97 code• Line In / Line Out / Mic In / AUX In / CD In / TEL / SPDIF / Game Port
On-Board LAN	<ul style="list-style-type: none">• 82559(Optional)
PS/2 Connector	<ul style="list-style-type: none">• PS/2[®] Keyboard interface and PS/2[®] Mouse interface
BIOS	<ul style="list-style-type: none">• Licensed AWARD BIOS, 4M bit FLASH ROM
Additional Features	<ul style="list-style-type: none">• Internal/External Modem Wake up• Keyboard Password Wake up• LAN Wake up• USB KB/Mouse Wake up from STR• Support STR Function• System after AC back
Drivers & Utilities	<ul style="list-style-type: none">• Display/Bus Master/Audio/Network Driver• Patch 95/98 Utility• DirectX 6.1• Intel[®] LDCM[®]• Adobe[®] Acrobat Reader

6WMZ7 Series Motherboard Layout

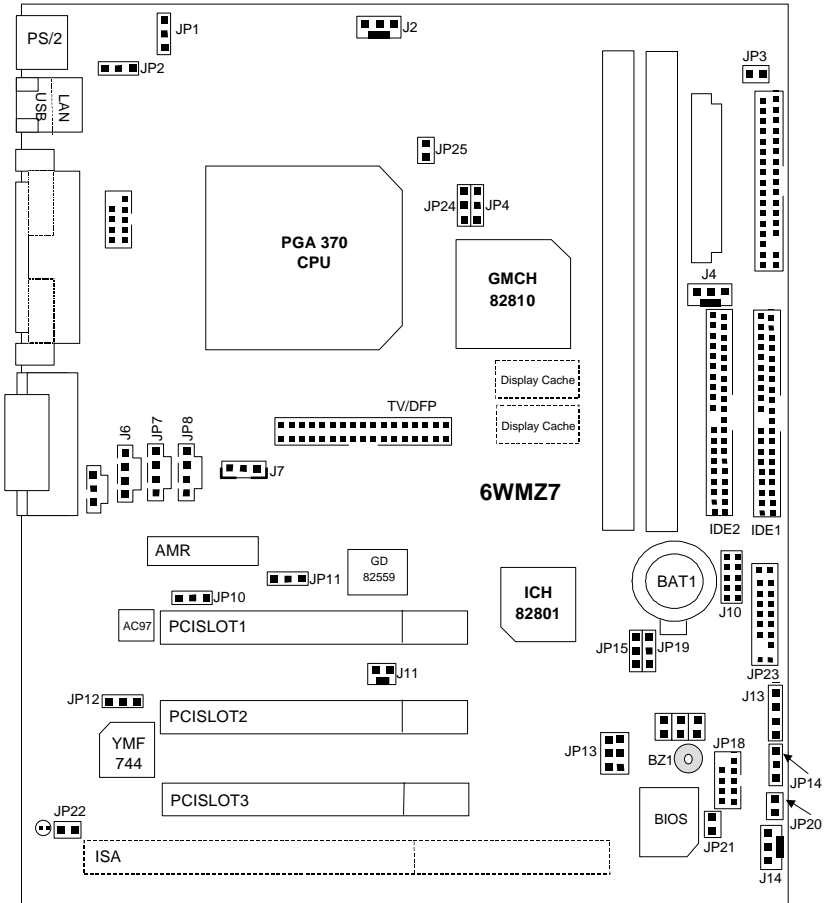

Page Index for CPU Speed Setup/Connectors/Panel and Jumper Definition	Page
CPU Speed Setup	P.7
Connectors	P.8
Game & Audio Port	P.8
COMA / VGA / LPT Port	P.8
COMB Port	P.9
USB & LAN Connector	P.9
TV/DFP	P.10
PS/2 Keyboard & PS/2 Mouse Connector	P.10
CPU / Power Cooling FAN Power Connector	P.11
System Cooling FAN Power Connector	P.12
ATX Power	P.12
JP18 (Front Panel USB Port)	P.13
J10 (IR/CIR)	P.13
Floppy Port	P.14
IDE 1(Primary)/ IDE 2(Secondary) Port	P.14
J11 (Ring Power On)	P.15
J7 (Wake On LAN)	P.15
J6 (CD Audio Line In)	P.16
JP7 (AUX IN)	P.16
JP8 (TEL)	P.17
JP6 (SPDIF)	P.17
JP22 (STR LED Connector & DIMM LED)	P.18
J13 (Speaker Jumper)	P.18
Panel and Jumper Definition	P.19
JP23 (2x11 pins jumper)	P.19
JP1 (Keyboard Power On)	P.20
JP2 (USB Device Wake up Selection)	P.20
JP19 (Clear CMOS Function)	P.21
JP15 (Safe mode/Recovery/Normal)	P.21
JP17 (Case Open)	P.22
J12 (Buzzer Enable)[Optional]	P.22
JP16 (Timeout Reboot Function)	P.23
JP21 (Top Block Lock)	P.23
JP13 (USB Port Selection)	P.24
JP12 (Onboard Sound Function Selection)	P.24
JP10 (AMR Select)	P.25
JP3 (LAN Power On & STR Connector)	P.25
JP14 (Power LED)	P.26
JP20 (Green LED)	P.26
JP11 (Onboard LAN Function)	P.27
JP25 (Cyrix CPU Turbo Function)[Optional]	P.27
BAT 1	P.28

CPU Speed Setup

The system bus frequency can be switched at 66MHz, 100MHz, 133MHz and Auto by adjusting JP4/JP24 (See Figure 1). The CPU Frequency is control by BIOS.

- ⚠ The CPU speed must match with the frequency RATIO. It will cause system hanging up if the frequency RATIO is higher than that of CPU.

JP4/JP24 : CPU Speed Setup

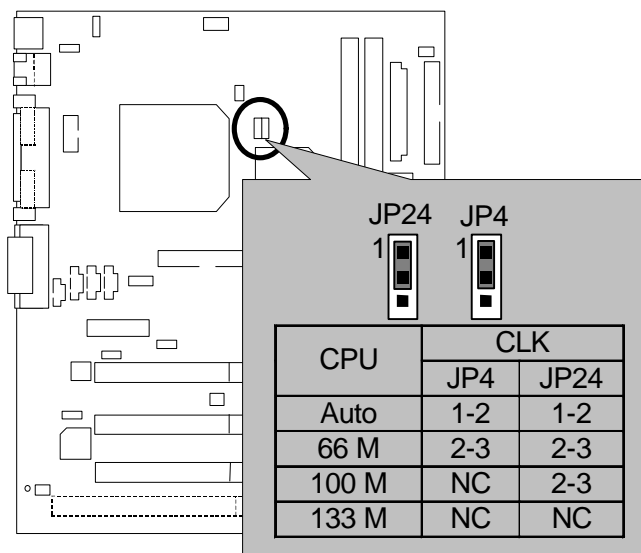
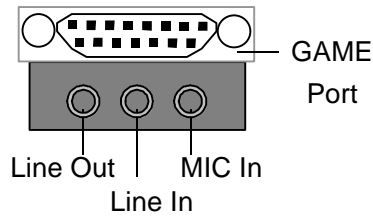
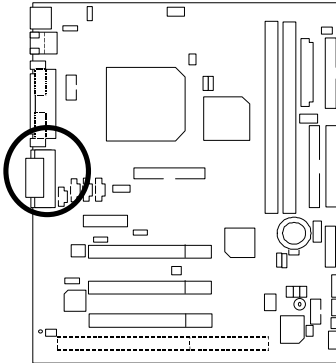

Figure 1

- ★ Note: Please set the CPU host frequency in accordance with your processor's specifications. We don't recommend you to set the system bus frequency over the CPU's specification because these specific bus frequencies are not the standard specifications for CPU, chipset and most of the peripherals. Whether your system can run under these specific bus frequencies properly will depend on your hardware configurations, including CPU, Chipsets, SDRAM, Cards... etc.
- ★ Note : JP24 is only available when the motherboard use 82810E chipset.
- ★ Note : 133MHz only 82810E support.

Connectors

Game & Audio Port



COM A / VGA / LPT Port

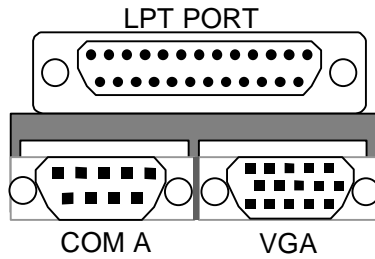
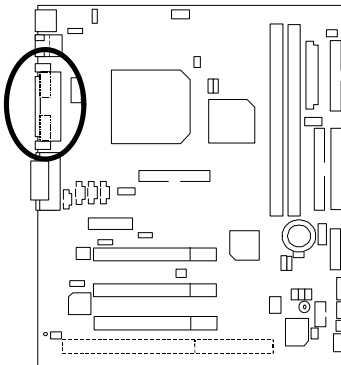

COMB Port

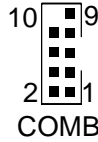
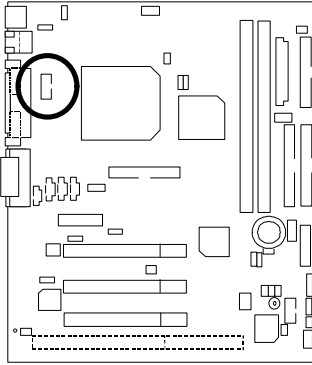

USB & LAN Connector

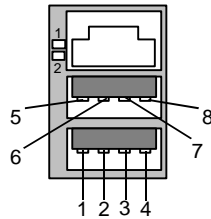
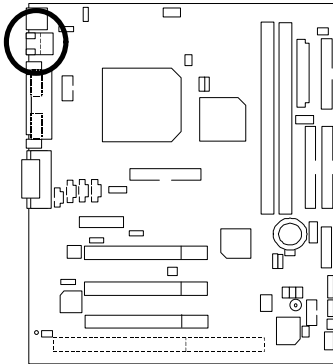

Pin No.	Definition
1	USB V0
2	USB D0-
3	USB D0+
4	GND
5	USB V1
6	USB D1-
7	USB D1+
8	GND

- 1 – Green LED
(LAN Link LED)
- 2 - Yellow LED
(LAN Active LED)

TV/DFP : TV-Out / Digital Flat Panel Daughter card connector.

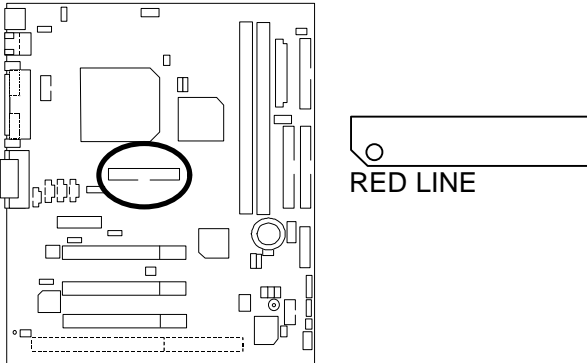

PS/2 Keyboard & PS/2 Mouse Connector

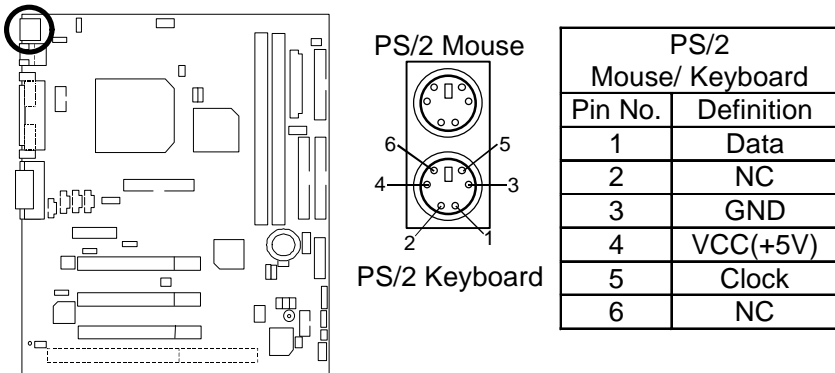

CPU Cooling FAN Power Connector

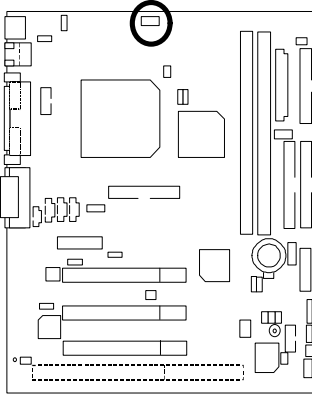

Pin No.	Definition
1	GND
2	+12V
3	SENSE

Power Cooling FAN Power Connector

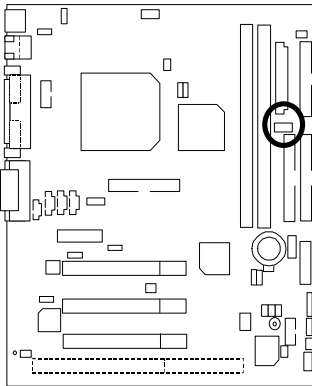

Pin No.	Definition
1	GND
2	+12V
3	SENSE

System Cooling FAN Power Connector

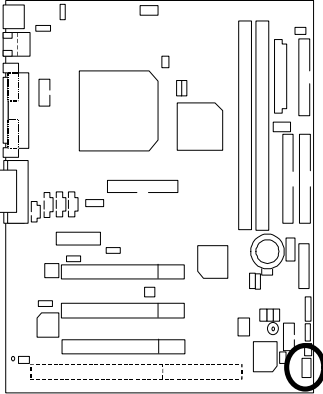

Pin No.	Definition
1	GND
2	+12V
3	SENSE

ATX Power

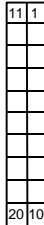
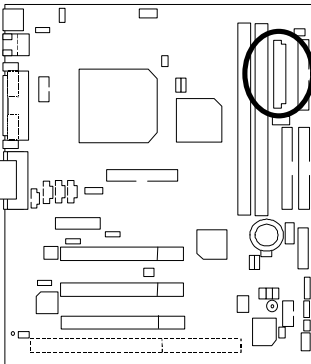

Pin No.	Definition
3,5,7,13,15-17	GND
1,2,11	3.3V
4,6,19,20	VCC
10	+12V
12	-12V
18	-5V
8	Power Good
9	5V SB stand by+5V
14	PS-ON(Soft On/Off)

JP18 : Front Panel USB Port

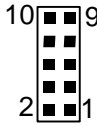
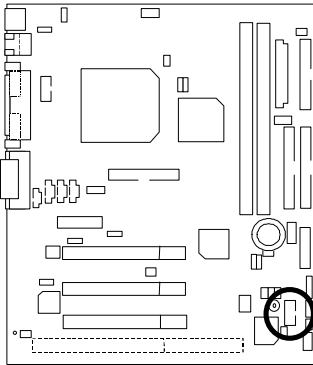

Pin No.	Definition
1,4,5,10	NC
2	+5V
3,7,9	GND
6	USBP0+
8	USBP0-

J10 : IR/CIR

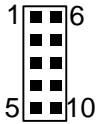
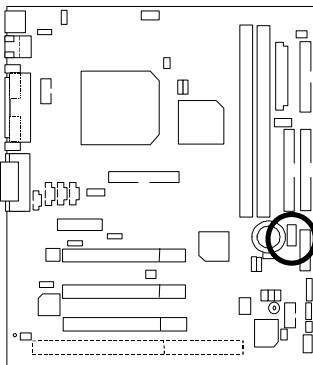

Pin No.	Definition
1	VCC
2	NC
3	IRRX
4	GND
5	IRTX
6	NC
7	CIRRX
8	VCC
9	NC
10	NC

Floppy Port

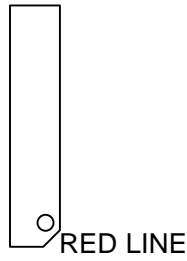
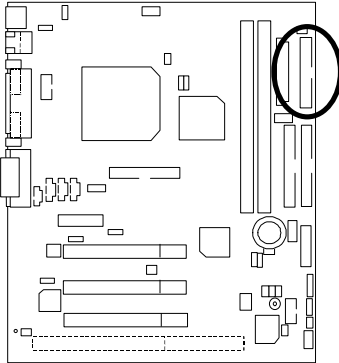

IDE1(Primary) , IDE2 (Secondary) Port

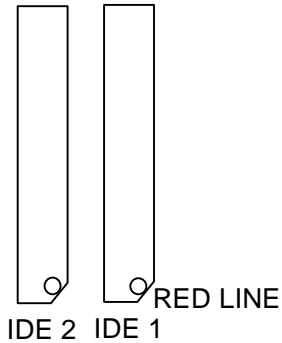
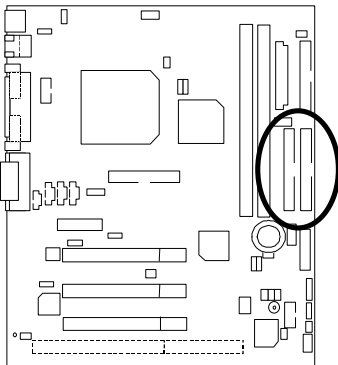

J11 : Ring Power On (Internal Modem Card Wake Up)

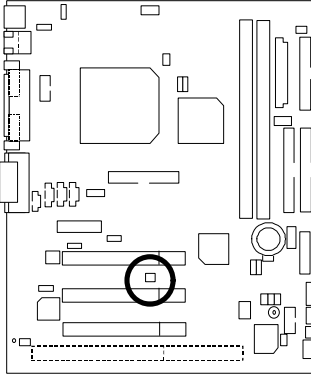

Pin No.	Definition
1	Signal
2	GND

J7 : Wake on LAN

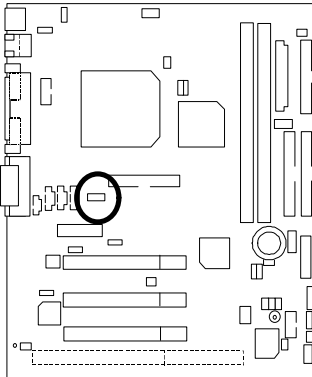

Pin No.	Definition
1	+5V SB
2	GND
3	Signal

J6 : CD Audio Line In

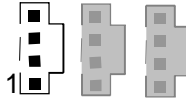
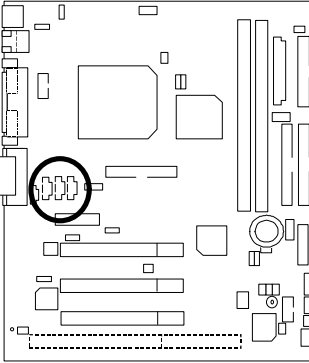

Pin No.	Definition
1	CD-L
2	GND
3	GND
4	CD-R

JP7 : AUX IN

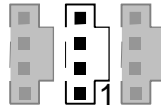
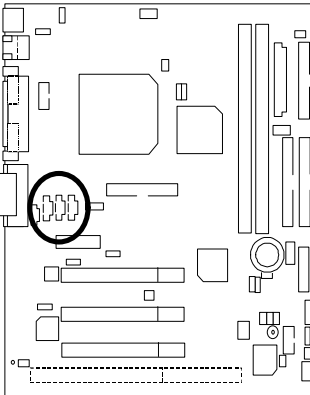

Pin No.	Definition
1	AUX-L
2	GND
3	GND
4	AUX-R

JP8 : TEL: The connector is for Modem with internal voice connector

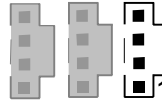
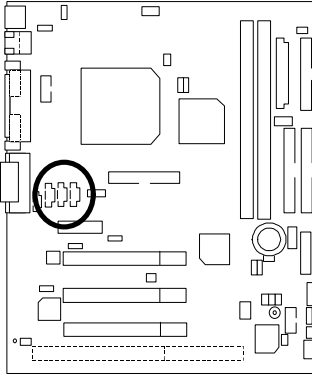

Pin No.	Definition
1	Signal-In
2	GND
3	GND
4	Signal-Out

JP6 : SPDIF(The SPDIF output is capable of providing digital audio to external speakers or compressed AC3 data to an external Dobby digital decoder.)

★ Note : JP6 is only available when the motherboard use YMF744.

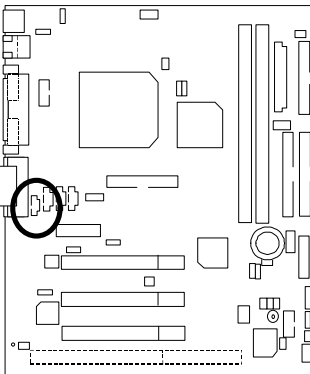

Pin No.	Definition
1	VCC
2	SPD OUT
3	GND

JP22 : STR LED Connector & DIMM LED

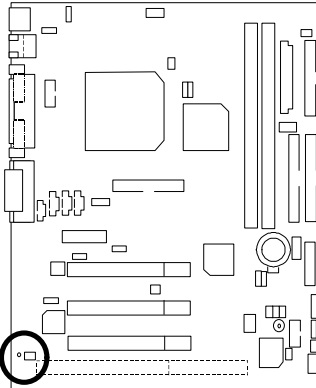

STR LED Connector External



J13 : Speaker Jumper

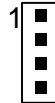
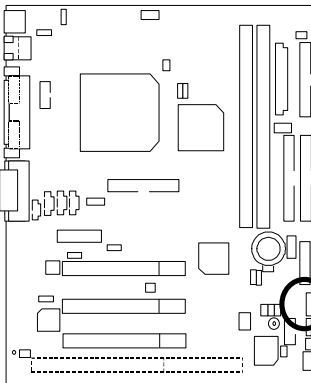

Pin No.	Definition
1	VCC(+)
2-3	NC
4	Data(-)

Panel and Jumper Definition

JP23 : For 2X11 Pins Jumper

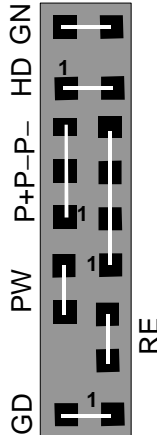
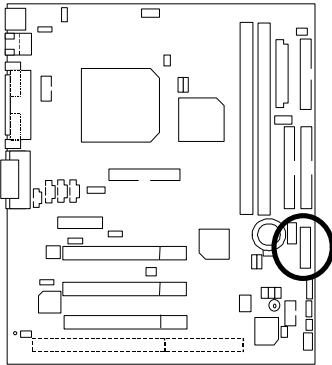

GN (Green Switch)	Open: Normal Operation Close: Entering Green Mode
GD (Green LED)	Pin 1: LED anode(+) Pin 2: LED cathode(-)
HD (IDE Hard Disk Active LED)	Pin 1: LED anode(+) Pin 2: LED cathode(-)
SPK (Speaker Connector)	Pin 1: VCC(+) Pin 2- Pin 3: NC Pin 4: Data(-)
RE (Reset Switch)	Open: Normal Operation Close: Reset Hardware System
P+P-P-(Power LED)	Pin 1: LED anode(+) Pin 2: LED cathode(-) Pin 3: LED cathode(-)
PW (Soft Power Connector)	Open: Normal Operation Close: Power On/Off

JP1 : Keyboard Power On

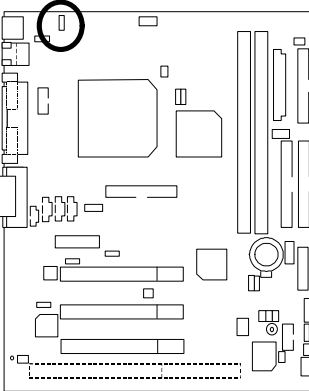

Pin No.	Definition
1-2 close	Keyboard Power on Enabled
2-3 close	Keyboard Power on Disabled (Default)

JP2 : USB Device Wake up Selection

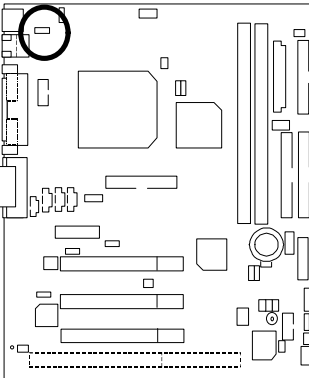

Pin No.	Definition
1-2 close	Enabled USB Device Wake up
2-3 close	Disabled USB Device Wake up(Default)

(If you want to use **"USB KB/Mouse Wake from S3"** function, you have to set the BIOS setting "USB KB/Mouse Wake from S3" enabled, and the jumper **"JP2"** enabled).
 *(Power on the computer and as soon as memory counting starts, press . You will enter BIOS Setup. Select the item **"POWER MANAGEMENT SETUP"**, then select **"USB KB/Mouse Wake from S3"**. Remember to save the setting by pressing "ESC" and choose the "SAVE & EXIT SETUP" option.)

JP19 : Clear CMOS Function

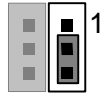
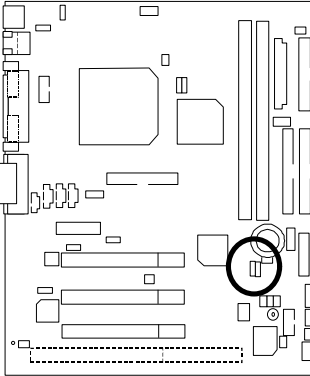

Pin No.	Definition
1-2 close	Clear CMOS
2-3 close	Normal (Default)

JP15 : Recovery/Safe mode/Normal

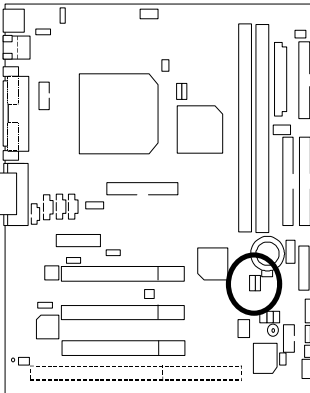

Pin No.	Definition
1-2close	Normal(Default)
2-3close	Safe mode
1-2-3open	Recovery

JP17 : Case Open

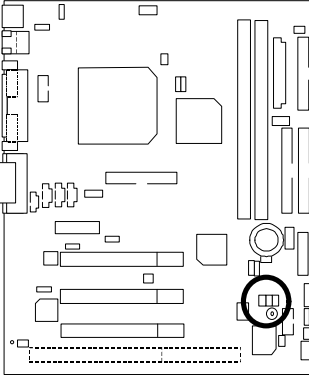

Pin No.	Definition
1	Signal
2	GND

J12 : Buzzer Enable (Optional)

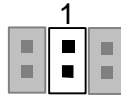
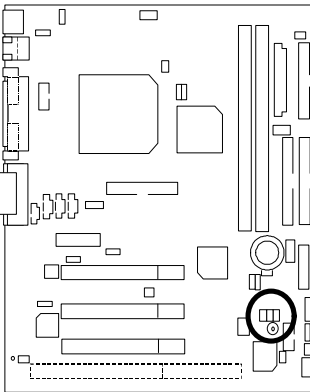

Pin No.	Definition
Open	Internal Buzzer Disable
Close	Internal Buzzer Enable (Default)

JP16 : Timeout Reboot Function

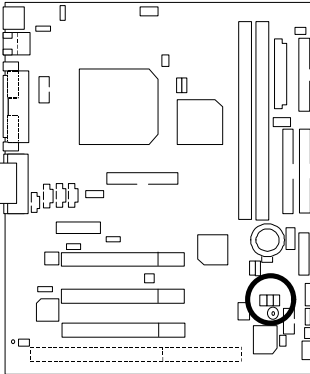

Pin No.	Definition
Open	Timeout reboot
Close	No Reboot on timeout

JP21 : Top Block Lock

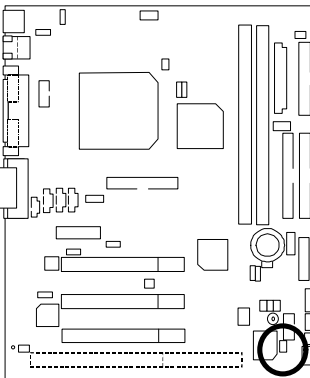

Pin No.	Definition
Open	TBL Lock
Close	Unlock

JP13 : USB Port Selection

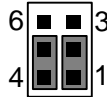
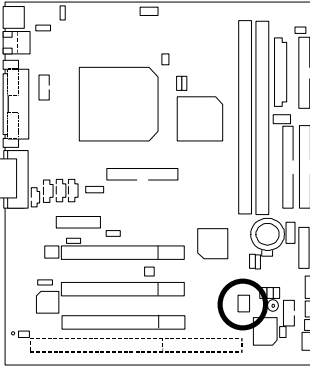

Front Panel USB Enable	Back Panel USB Enable
FPUSB(Default)	BPUSB
1-2close	2-3close
4-5close	5-6close

JP12 : Onboard Sound Function Selection

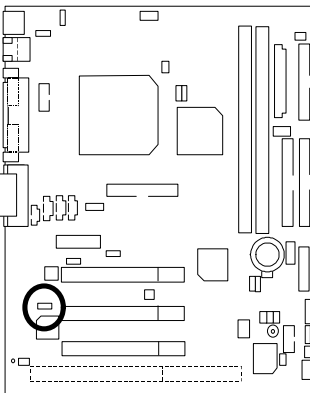

Pin No.	Definition
1-2 close	Disable Onboard Sound
2-3 close	Enable Onboard Sound (Default)

JP10 : AMR Select

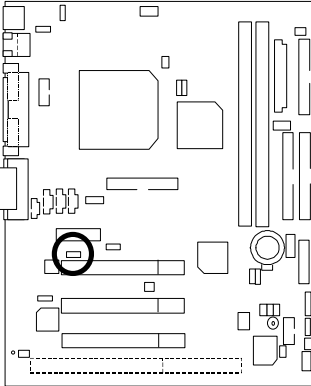

Pin No.	Definition
1-2close	AMR Secondary
2-3close	AC'97 Disabled (Disabled Onboard CODEC)

JP3 : LAN Power On & STR Connector

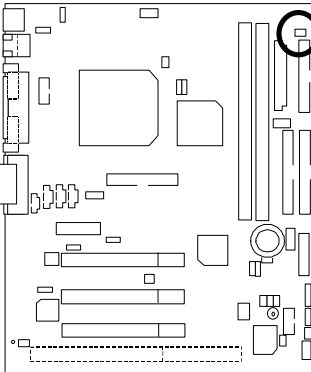

Pin No.	Definition
Open	Disable LAN Power On & STR(Default)
Close	Enable LAN Power On & STR

JP14 : Power LED

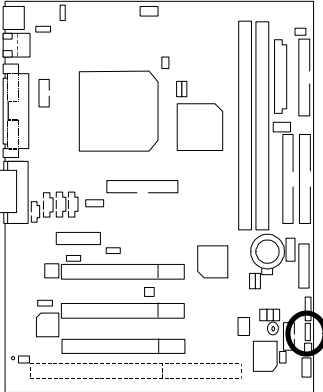

Pin No.	Definition
1	LED anode(+)
2	LED cathode(-)
3	LED cathode(-)

JP20 : Green LED

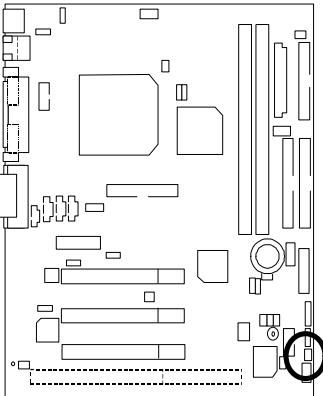

Pin No.	Definition
1	LED anode(-)
2	LED cathode(+)

JP11 : Onboard LAN Function

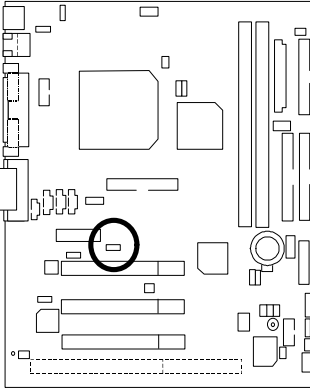

Pin No.	Definition
1-2 short	Onboard LAN Disable
2-3 short	Onboard LAN Enable (Default)

JP25 : Cyrix CPU Turbo Function (Optional)

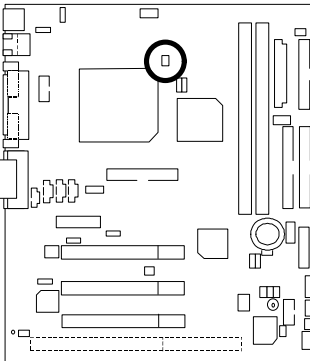

Pin No.	Definition
Open	Normal
Close	Turbo

BAT1 : Battery

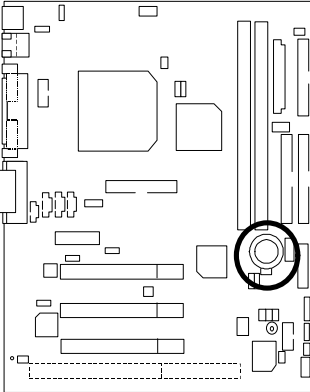

- ⚠ Danger of explosion if battery is incorrectly replaced.
- ⚠ Replace only with the same or equivalent type recommended by the manufacturer.
- ⚠ Dispose of used batteries according to the manufacturer's instructions.

Performance List

The following performance data list is the testing results of some popular benchmark testing programs.

These data are just referred by users, and there is no responsibility for different testing data values gotten by users. (The different Hardware & Software configuration will result in different benchmark testing results.)

- CPU Intel® Celeron™ 533MHz processor,
Intel® Coppermine 600MHz processor
- DRAM (128x1) MB SDRAM (LGS GM72V66841ET7J)
- CACHE SIZE 128 KB included in CPU
- DISPLAY Onboard Intel Corporation 810 Graphics Controller Hub (4MB SDRAM)
- STORAGE Onboard IDE (Quantum KA13600AT)
- O.S. Windows NT™ 4.0 SPK5
- DRIVER Display Driver at 1024 x 768 65536 colors 75Hz.
Intel Ultra ATA Storage Driver V5.0 Engineering Sample
, Build 12i (v5.00.0012i)

Processor	Intel® Celeron™ 533(66x8)	Intel® Coppermine 600(100x6)	Intel® Coppermine 600(133x4.5)
Winbench99			
CPU mark 99	38.2	54.2	54.3
FPU Winmark 99	2860	3230	3230
Business Disk Winmark 99	4390	5100	5630
Hi-End Disk Winmark 99	12100	12800	13000
Business Graphics Winmark 99	140	183	175
Hi-End Graphics Winmark 99	356	477	485
Winstone99			
Business Winstone99	29.8	35.5	36
Hi-End Winstone99	27.1	33.1	32.9

Block Diagram

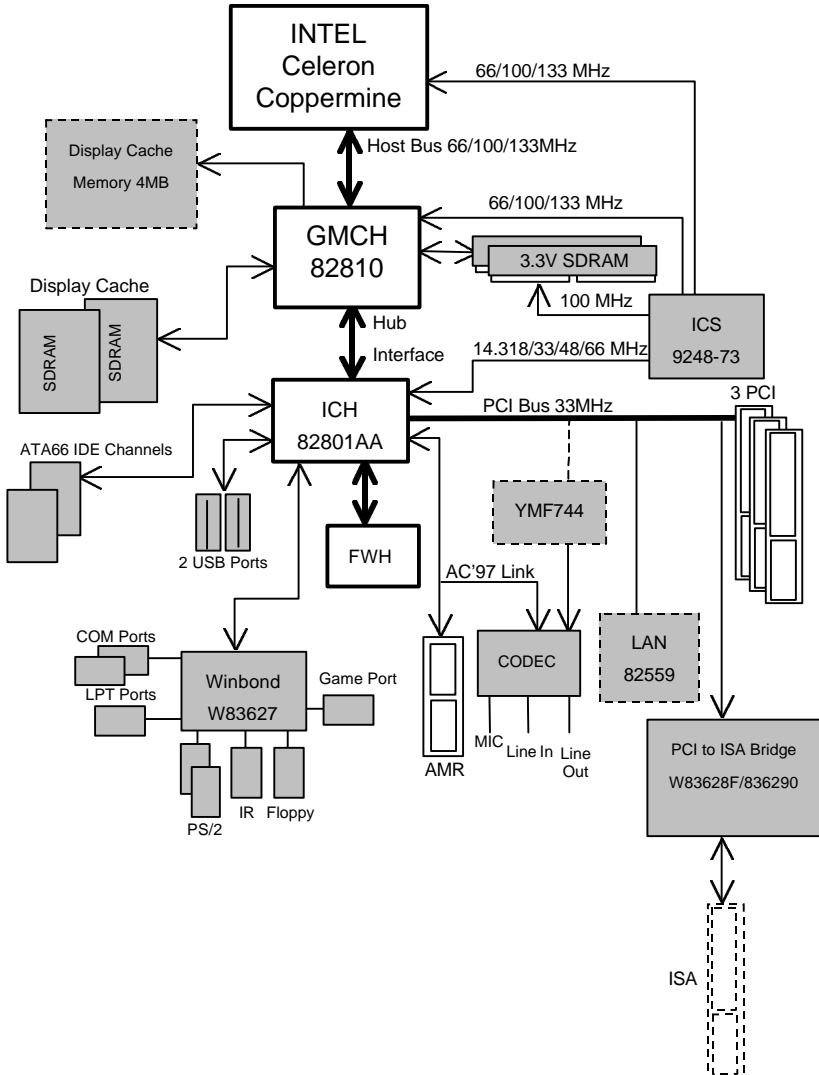

Suspend to RAM Installation

A.1 Introduce STR function:

Suspend-to-RAM (STR) is a Windows 98 ACPI sleep mode function. When recovering from STR (S3) sleep mode, the system is able, in just a few seconds, to retrieve the last "state" of the system before it went to sleep and recover to that state. The "state" is stored in memory (RAM) before the system goes to sleep. During STR sleep mode, your system uses only enough energy to maintain critical information and system functions, primarily the system state and the ability to recognize various "wake up" triggers or signals, respectively.

A.2 STR function Installation

Please use the following steps to complete the STR function installation.

Step-By-Step Setup

Step 1:

To utilize the STR function, the system must be in Windows 98 ACPI mode.

Putting Windows 98 into ACPI mode is fairly easy.

Setup with Windows 98 CD:

- A. Insert the Windows 98 CD into your CD-ROM drive, select Start, and then Run.
- B. Type (without quotes) **"D:\setup /p j"** in the window provided. Hit the enter key or click OK.
- C. After setup completes, remove the CD, and reboot your system
(This manual assumes that your CD-ROM device drive letter is D:).

Step 2:

(If you want to use STR Function, please set jumper JP3 Closed.)

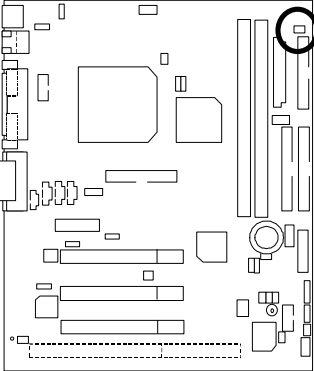

Pin No.	Definition
Open	Disable LAN Power On & STR
Close	Enable LAN Power On & STR(Default)

Step 3:

Power on the computer and as soon as memory counting starts, press . You will enter BIOS Setup. Select the item "**POWER MANAGEMENT SETUP**", then select "**ACPI Suspend Type:S3 (Suspend to RAM)**". Remember to save the settings by pressing "ESC" and choose the "**SAVE & EXIT SETUP**" option.

Congratulation! You have completed the installation and now can use the STR function.

6WMZ7 Series Motherboard

2. Define the system “power on” button to initiate STR sleep mode:

A. Double click “My Computer” and then “Control Panel”

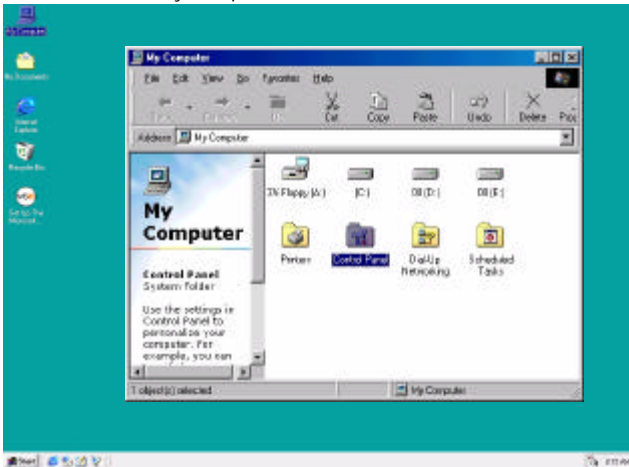

B. Double click the “Power Management” item.

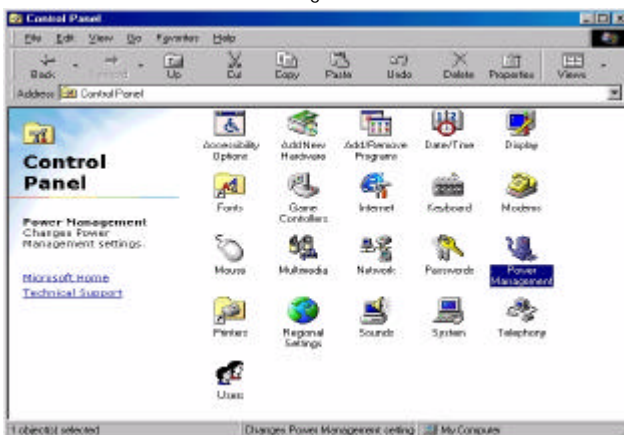

C. Select the “Advanced” tab and “Standby” mode in Power Buttons.

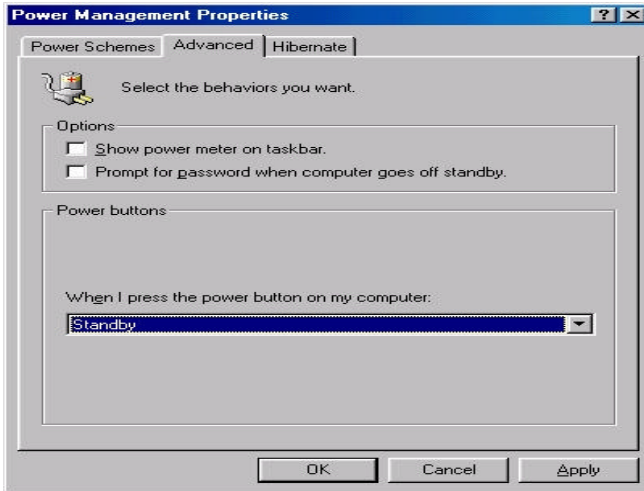

Step 4:

Restart your computer to complete setup.

Now when you want to enter STR sleep mode, just momentarily press the “Power on” button..

A.4 How to recover from the STR sleep mode?

There are seven ways to “wake up” the system:

1. Press the “Power On” button.
2. Use the “Keyboard Power On” function.
3. Use the “Mouse Power On” function.
4. Use the “Resume by Alarm” function.
5. Use the “Modem Ring On” function.
6. Use the “Wake On LAN” function.
7. Use the “USB Device Wake up” function.

A.5 Notices :

In order for STR to function properly, several hardware and software requirements must be satisfied:

- A. Your ATX power supply must comply with the ATX 2.01 specification (provide more than 720 mA 5V Stand-By current).
 - B. Your SDRAM must be PC-100 compliant.
2. Jumper JP22 is provided to connect to the STR LED in your system chassis. [Your chassis may not provide this feature.] The STR LED will be illuminated when your system is in STR sleep mode.

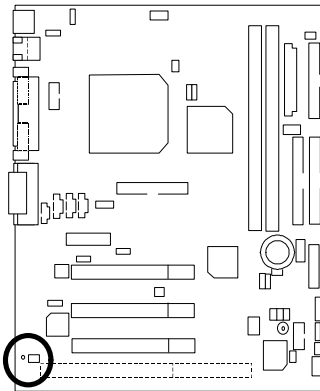

STR LED Connector External



1

RAM Indicator LED1

Memory Installation

The motherboard has 2 dual inline memory module (DIMM) sockets. The BIOS will automatically detects memory type and size. To install the memory module, just push it vertically into the DIMM Slot .The DIMM module can only fit in one direction due to the two notch. Memory size can vary between sockets.

Install memory in any combination table:

DIMM	168-pin SDRAM DIMM Modules	
DIMM1	Supports 16 / 32 / 64 / 128 / 256 MB	X 1 pcs
DIMM2	Supports 16 / 32 / 64 / 128 / 256 MB	X 1 pcs

 Page Index for BIOS Setup	Page
The Main Menu	P.40
Standard CMOS Features	P.43
Advanced BIOS Features	P.47
Advanced Chipset Features	P.51
Integrated Peripherals	P.53
Power Management Setup	P.59
PnP/ PCI Configuration	P.63
PC Health status	P.65
Frequency / Voltage Control	P.67
Load Fail-Safe Defaults	P.68
Load Optimized Defaults	P.69
Set Supervisor / User Password	P.70
SAVE to CMOS and EXIT	P.71
EXIT Without Saving	P.72

BIOS Setup

BIOS Setup is an overview of the BIOS Setup Program. The program that allows users to modify the basic system configuration. This type of information is stored in battery-backed CMOS RAM so that it retains the Setup information when the power is turned off.

ENTERING SETUP

Power ON the computer and press immediately will allow you to enter Setup. If the message disappears before you respond and you still wish to enter Setup, restart the system to try again by turning it OFF then ON or pressing the "RESET" bottom on the system case. You may also restart by simultaneously press <Ctrl> – <Alt>– keys.

CONTROL KEYS

<↑>	Move to previous item
<↓>	Move to next item
<←>	Move to the item in the left hand
<→>	Move to the item in the right hand
<Esc>	Main Menu - Quit and not save changes into CMOS Status Page Setup Menu and Option Page Setup Menu - Exit current page and return to Main Menu
<+/PgUp>	Increase the numeric value or make changes
<-/PgDn>	Decrease the numeric value or make changes
<F1>	General help, only for Status Page Setup Menu and Option Page Setup Menu
<F2>	Reserved
<F3>	Reserved
<F4>	Reserved
<F5>	Restore the previous CMOS value from CMOS, only for Option Page Setup Menu
<F6>	Load the default CMOS value from BIOS default table, only for Option Page Setup Menu
<F7>	Load the Optimized Defaults
<F8>	Reserved
<F9>	Reserved
<F10>	Save all the CMOS changes, only for Main Menu

GETTING HELP

Main Menu

The on-line description of the highlighted setup function is displayed at the bottom of the screen.

Status Page Setup Menu / Option Page Setup Menu

Press F1 to pop up a small help window that describes the appropriate keys to use and the possible selections for the highlighted item. To exit the Help Window press <Esc>.

The Main Menu

Once you enter Award BIOS CMOS Setup Utility, the Main Menu (Figure 2) will appear on the screen. The Main Menu allows you to select from nine setup functions and two exit choices. Use arrow keys to select among the items and press <Enter> to accept or enter the sub-menu.

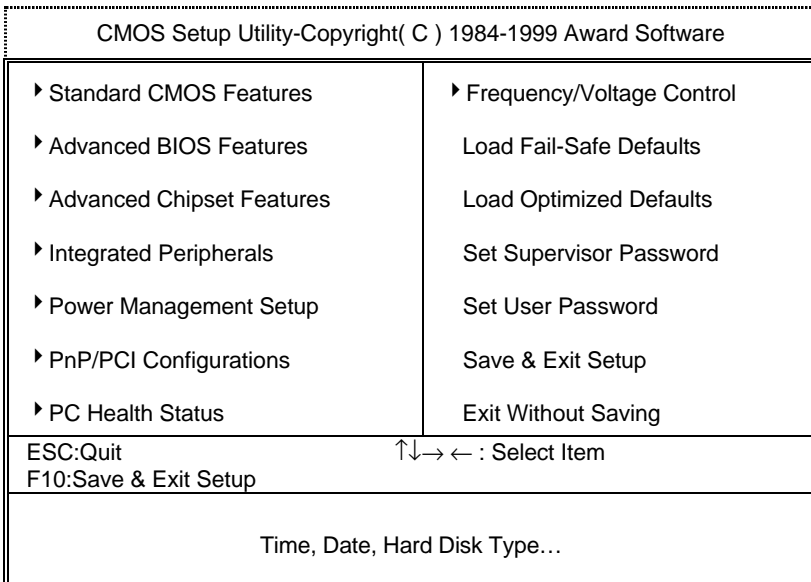

Figure 2: Main Menu

- **Standard CMOS Features**

This setup page includes all the items in standard compatible BIOS.

- **Advanced BIOS Features**

This setup page includes all the items of Award special enhanced features.

- **Advanced Chipset Features**

This setup page includes all the items of chipset special features.

- **Integrated Peripherals**

This setup page includes all onboard peripherals.

- **Power Management Setup**

This setup page includes all the items of Green function features.

- **PnP/PCI Configurations**

This setup page includes all the configurations of PCI & PnP ISA resources.

- **PC Health Status**

This setup page is the System auto detect Temperature, voltage , fan, speed.

- **Frequency/Voltage Control**

This setup page is control CPU' s clock and frequency ratio.

- **Load Fail-Safe Defaults**

Fail-Safe Defaults indicates the value of the system parameters which the system would be in safe configuration.

- **Load Optimized Defaults**

Optimized Defaults indicates the value of the system parameters which the system would be in best performance configuration.

- **Set Supervisor password**

Change, set, or disable password. It allows you to limit access to the system and Setup, or just to Setup.

- **Set User password**

Change, set, or disable password. It allows you to limit access to the system.

- **Save & Exit Setup**
Save CMOS value settings to CMOS and exit setup.
- **Exit Without Saving**
Abandon all CMOS value changes and exit setup.

Standard CMOS Features

The items in Standard CMOS Setup Menu (Figure 3) are divided into 9 categories. Each category includes no, one or more than one setup items. Use the arrows to highlight the item and then use the <PgUp> or <PgDn> keys to select the value you want in each item.

CMOS Setup Utility-Copyright(C) 1984-1999 Award Software Standard CMOS Features		
Date (mm:dd:yy)	Thu , Jan 7 1999	Item Help
Time (hh:mm:ss)	2 : 31 : 24	
▶ IDE Primary Master	Press Enter None	Menu Level ▶
▶ IDE Primary Slave	Press Enter None	Change the
▶ IDE Secondary Master	Press Enter None	Day, month,
▶ IDE Secondary Slave	Press Enter None	Year and
		century
Drive A	1.44M, 3.5 in.	
Drive B	None	
Floppy 3 Mode Support	Disabled	
Video	EGA / VGA	
Halt On	All, But Keyboard	
Base Memory	640K	
Extended Memory	63488K	
Total Memory	64512K	
↑↓→ ←:Move Enter:Select +/-/PU/PD:Value F10:Save ESC:Exit F1:General Help F5:Previous Values F6:Fail-Safe Defaults F7:Optimized Defaults		

Figure 3: Standard CMOS Features

• Date

The date format is <day>, <month> <date> <year>.

day	The day, from Sun to Sat, determined by the BIOS and is display-only
month	The month, Jan. Through Dec.
date	The date, from 1 to 31 (or the maximum allowed in the month)
year	The year, from 1994 through 2079

- **Time**

The times format in <hour> <minute> <second>. The time is calculated base on the 24-hour military-time clock. For example, 1 p.m. is 13:00:00.

- **IDE Primary Master, Slave / Secondary Master, Slave**

The category identifies the types of hard disk from drive C to F that has been installed in the computer. There are two types: auto type, and user definable type. User type is user-definable; Auto type which will automatically detect HDD type.

Note that the specifications of your drive must match with the drive table. The hard disk will not work properly if you enter improper information for this category.

If you select User Type, related information will be asked to enter to the following items. Enter the information directly from the keyboard and press <Enter>. Such information should be provided in the documentation form your hard disk vendor or the system manufacturer.

CYLS.	Number of cylinders
HEADS	number of heads
PRECOMP	write precomp
LANDZONE	Landing zone
SECTORS	number of sectors

If a hard disk has not been installed select NONE and press <Enter>.

- **Drive A type / Drive B type**

The category identifies the types of floppy disk drive A or drive B that has been installed in the computer.

None	No floppy drive installed
360K, 5.25 in.	5.25 inch PC-type standard drive; 360K byte capacity.
1.2M, 5.25 in.	5.25 inch AT-type high-density drive; 1.2M byte capacity (3.5 inch when 3 Mode is Enabled).
720K, 3.5 in.	3.5 inch double-sided drive; 720K byte capacity
1.44M, 3.5 in.	3.5 inch double-sided drive; 1.44M byte capacity.
2.88M, 3.5 in.	3.5 inch double-sided drive; 2.88M byte capacity.

- **Floppy 3 Mode Support (for Japan Area)**

Disabled	Normal Floppy Drive.
Drive A	Drive A is 3 mode Floppy Drive.
Drive B	Drive B is 3 mode Floppy Drive.
Both	Drive A & B are 3 mode Floppy Drives.

- **Video**

The category detects the type of adapter used for the primary system monitor that must match your video display card and monitor. Although secondary monitors are supported, you do not have to select the type in setup.

EGA/VGA	Enhanced Graphics Adapter/Video Graphics Array. For EGA, VGA, SVGA, or PGA monitor adapters
CGA 40	Color Graphics Adapter, power up in 40 column mode
CGA 80	Color Graphics Adapter, power up in 80 column mode
MONO	Monochrome adapter, includes high resolution monochrome adapters

- **Halt on**

The category determines whether the computer will stop if an error is detected during power up.

NO Errors	The system boot will not stop for any error that may be detected and you will be prompted
All Errors	Whenever the BIOS detects a non-fatal error the system will be stopped
All, But Keyboard	The system boot will not stop for a keyboard error; it will stop for all other errors
All, But Diskette	The system boot will not stop for a disk error; it will stop for all other errors
All, But Disk/Key	The system boot will not stop for a keyboard or disk error; it will stop for all other errors

- **Memory**

The category is display-only which is determined by POST (Power On Self Test) of the BIOS.

Base Memory

The POST of the BIOS will determine the amount of base (or conventional) memory installed in the system.

The value of the base memory is typically 512 K for systems with 512 K memory installed on the motherboard, or 640 K for systems with 640 K or more memory installed on the motherboard.

Extended Memory

The BIOS determines how much extended memory is present during the POST.

This is the amount of memory located above 1 MB in the CPU's memory address map.

Advanced BIOS Features

CMOS Setup Utility-Copyright(C) 1984-1999 Award Software Advanced BIOS Features		
Virus Warning	Disabled	Item Help
CPU Cache	Enabled	Menu Level ▶
CPU L2 Cache ECC Checking	Disabled	Allows you to
Quick Power On Self Test	Enabled	choose the VIRUS
First Boot Device	Floppy	Warning feature
Second Boot Device	HDD-0	For IDE Hard disk
Third Boot Device	LS/ZIP	Boot sector
Boot Other Device	Enabled	Protection. If this
Swap Floppy Drive	Disabled	Function is enable
Boot Up Floppy Seek	Enabled	And someone
Boot Up NumLock Status	On	Attempt to write
Gate A20 Option	Fast	Data into this area
Typematic Rate Setting	Disabled	, BIOS will show
Typematic Rate (Chars/Sec)	6	A warning
Typematic Delay (Msec)	250	Message on
Security Option	Setup	Screen and alarm
OS Select For DRAM >64MB	Non-OS2	beep
HDD S.M.A.R.T. Capability	Disabled	
Report No FDD For WIN 95	No	

↑↓→ ←:Move Enter:Select +/-/PU/PD:Value F10:Save ESC:Exit F1:General Help
F5:Previous Values F6:Fail-Safe Defaults F7:Optimized Defaults

Figure 4: Advanced BIOS Features

- **Virus Warning**

If it is set to enable, the category will flash on the screen when there is any attempt to write to the boot sector or partition table of the hard disk drive. The system will halt and the following error message will appear in the mean time. You can run anti-virus program to locate the problem.

Enabled	Activate automatically when the system boots up causing a warning message to appear when anything attempts to access the boot sector or hard disk partition table.
Disabled	No warning message to appear when anything attempts to access the boot sector or hard disk partition table. (Default value)

- **CPU Cache**

These two categories speed up memory access. However, it depends on CPU / chipset design.

Enabled	Enable cache. (Default value)
Disabled	Disable cache.

- **CPU L2 Cache ECC Checking**

Enabled	Enable CPU L2 Cache ECC Checking.
Disabled	Disable CPU L2 Cache ECC Checking. (Default value)

- **Quick Power On Self Test**

This category speeds up Power On Self Test (POST) after you power on the computer. If it is set to Enable, BIOS will shorten or skip some check items during POST.

Enabled	Enable quick POST. (Default value)
Disabled	Normal POST.

- **First / Second / Third Boot device**

Floppy	Select your boot device priority by Floppy.
LS/ZIP	Select your boot device priority by LS/ZIP.
HDD-0-3	Select your boot device priority by HDD-0-3.
SCSI	Select your boot device priority by SCSI.
CDROM	Select your boot device priority by CDROM.
Disable	Disable this function.
LAN	Select your boot device priority by LAN.

- **Boot other device**

Enabled	Enabled select your boot device priority function. (Default value)
Disabled	Disabled this function.

- **Swap Floppy Drive**

Enabled	Floppy A & B will be swapped under DOS.
Disabled	Floppy A & B will be normal definition. (Default value)

- **Boot Up Floppy Seek**

During POST, BIOS will determine the floppy disk drive installed is 40 or 80 tracks. 360 K type is 40 tracks 720 K, 1.2 M and 1.44 M are all 80 tracks.

Enabled	BIOS searches for floppy disk drive to determine it is 40 or 80 tracks. Note that BIOS can not tell from 720 K, 1.2 M or 1.44 M drive type as they are all 80 tracks. (Default value)
Disabled	BIOS will not search for the type of floppy disk drive by track number. Note that there will not be any warning message if the drive installed is 360 K.

- **Boot Up NumLock Status**

On	Keypad is number keys. (Default value)
Off	Keypad is arrow keys.

- **Gate A20 Option**

Normal	Set Gate A20 Option is Normal.
Fast	Set Gate A20 Option is Fast. (Default value)

- **Typematic Rate Setting**

Enabled	Enable Keyboard Typematic rate setting.
Disabled	Disable Keyboard Typematic rate setting. (Default value)

- **Typematic Rate (Chars / Sec.)**

6-30	Set the maximum Typematic rate from 6 chars. Per second to 30 characters. Per second. (Default value:6)
------	--

- **Typematic Delay (Msec.)**

250-1000	Set the time delay from first key to repeat the same key in to computer. (Default value:250)
----------	---

- **Security Option**

This category allows you to limit access to the system and Setup, or just to Setup.

System	The system can not boot and can not access to Setup page will be denied if the correct password is not entered at the prompt.
Setup	The system will boot, but access to Setup will be denied if the correct password is not entered at the prompt. (Default value)

- **OS Select For DRAM>64MB**

Non-OS2	Using non-OS2 operating system. (Default value)
OS2	Using OS2 operating system and DRAM>64MB.

- **HDD S.M.A.R.T. Capability**

Enabled	Enabled HDD S.M.A.R.T. Capability.
Disabled	Disabled HDD S.M.A.R.T. Capability. (Default value)

- **Report No FDD For WIN 95**

No	Assign IRQ6 For FDD. (Default value)
Yes	FDD Detect IRQ6 Automatically.

Advanced Chipset Features

CMOS Setup Utility-Copyright(C) 1984-1999 Award Software
Advanced Chipset Features

SDRAM CAS Latency Time	Auto	Item Help
SDRAM Cycle Time Tras/Trc	5/7	
SDRAM RAS-to-CAS Delay	2	Menu Level ▶
SDRAM RAS Precharge Time	2	
SDRAM Buffer Strength	Auto	
DRAM Page Closing Policy	Precharge Bank	
System BIOS Cacheable	Enabled	
Video BIOS Cacheable	Enabled	
Delayed Transaction	Disabled	
On-Chip Video Window Size	64MB	
Local Memory Frequency	100MHz	
* Onboard Display Cache Setting *		
Initial Display Cache	Enabled	
Display Cache Timing	Auto	

↑↓ → ←: Move Enter: Select +/-/PU/PD: Value F10: Save ESC: Exit F1: General Help
F5: Previous Values F6: Fail-Safe Defaults F7: Optimized Defaults

Figure 5: Advanced Chipset Features

- **SDRAM CAS latency Time**

Auto	Set SDRAM CAS latency Time to Auto. (Default value)
3	For 67 / 83 MHz SDRAM DIMM module.
2	For 100 MHz SDRAM DIMM module.

- **SDRAM Cycle Time Tras/Trc**

6/8	Set DRAM Tras/Trc Cycle time is 6/8 SCLks.
5/7	Set DRAM Tras/Trc Cycle time is 5/7 SCLks. (Default value)

- **SDRAM RAS-to-CAS delay**

3	Set SDRAM RAS-to-CAS delay 3 SCLks.
2	Set SDRAM RAS-to-CAS delay 2 SCLks. (Default value)

- **SDRAM RAS Precharge**

3	Set SDRAM RAS Precharge is 3.
2	Set SDRAM RAS Precharge is 2. (Default value)

- **SDRAM Buffer Strength**

Auto	Set SDRAM Buffer Strength is Auto. (Default Value)
Auto+1	Set SDRAM Buffer Strength is Auto+1.
Auto-1	Set SDRAM Buffer Strength is Auto-1.

- **DRAM Page Closing Policy**

Precharge Bank	Closing Policy Precharge Bank. (Default value)
Precharge All	Closing Policy Precharge All.

- **System BIOS Cacheable**

Enabled	Enable System BIOS Cacheable. (Default value)
Disabled	Disable System BIOS Cacheable.

- **Video BIOS Cacheable**

Enabled	Enable video BIOS Cacheable. (Default value)
Disabled	Disable video BIOS Cacheable.

- **Delayed Transaction**

Disabled	Normal operation. (Default value)
Enabled	For slow speed ISA device in system.

- **On-Chip Video Window Size**

32MB	Set Graphics Aperture Size to 32MB.
64MB	Set Graphics Aperture Size to 64MB. (Default value)

- **Local Memory Frequency (For 82810E)**

100MHz	Set Local Memory Frequency to 100MHz. (Default value)
133MHz	Set Local Memory Frequency to 133MHz.

- **Initialize Display Cache**

Disabled	Disabled Initialize Display Cache.
Enabled	Enabled Initialize Display Cache. (Default value)

Auto	Set Display Cache Timing to Auto. (Default value)
Fast	Set Display Cache Timing to Fast.
Normal	Set Display Cache Timing to Normal.

Integrated Peripherals

CMOS Setup Utility-Copyright(C) 1984-1999 Award Software Integrated Peripherals		
		Item Help
On-Chip Primary PCI IDE	Enabled	Menu Level ▶
On-Chip Secondary PCI IDE	Enabled	
IDE Primary Master PIO	Auto	
IDE Primary Slave PIO	Auto	
IDE Secondary Master PIO	Auto	
IDE Secondary Slave PIO	Auto	
IDE Primary Master UDMA	Auto	
IDE Primary Slave UDMA	Auto	
IDE Secondary Master UDMA	Auto	
IDE Secondary Slave UDMA	Auto	
USB Controller	Enabled	
USB Keyboard Support	Disabled	
Init Display First	PCI Slot	
AC97 Audio	Auto	
AC97 Modem	Auto	
IDE HDD Block Mode	Enabled	
POWER ON Function	BUTTON ONLY	
*KB Power ON Password	Enter	
Onboard FDC Controller	Enabled	
Onboard Serial Port 1	Auto	
Onboard Serial Port 2	Auto	
UART Mode Select	Normal	
*RxD, TxD Active	Hi,Lo	
*IR Transmittiion delay	Enabled	
Onboard Parallel Port	378/IRQ7	
Parallel Port Mode	SPP	
*EPP Mode Select	EPP1.7	
*ECP Mode Use DMA	3	
Game Port Address	201	
Midi Port Address	330	
Midi Port IRQ	10	

↑↓→←:Move Enter:Select +/-/PU/PD:Value F10:Save ESC:Exit F1:General Help
F5:Previous Values F6:Fail-Safe Defaults F7:Optimized Defaults

Figure 6: Integrated Peripherals

- **On-Chip Primary PCI IDE**

Enabled	Enable onboard 1st channel IDE port. (Default value)
Disabled	Disable onboard 1st channel IDE port.

- **On-**

Enabled	Enable onboard 2nd channel IDE port. (Default value)
Disabled	Disable onboard 2nd channel IDE port.

nel)

	BIOS will automatically detect the IDE HDD Accessing mode. (Default value)
Mode0-4	

- **IDE Primary Slave PIO (for onboard IDE 1st channel)**

Auto	BIOS will automatically detect the IDE HDD Accessing mode. (Default value)
Mode0-4	Manually set the IDE Accessing mode.

- **IDE Secondary Master PIO (for onboard IDE 2nd channel)**

	BIOS will automatically detect the IDE HDD Accessing mode. (Default value)
Mode0-4	Manually set the IDE Accessing mode.

Auto	BIOS will automatically detect the IDE HDD Accessing mode.
	Manually set the

- **IDE Primary Master UDMA**

Auto	BIOS will automatically detect the IDE HDD Accessing mode. (Default value)
Disabled	Disable UDMA function.

- **IDE Primary Slave UDMA**

uto	(Default value)
Disabled	Disable UDMA function.

- **IDE Secondary Master UDMA**

Auto	BIOS will automatically detect the IDE HDD Accessing mode. (Default value)
Disabled	Disable UDMA function.

-

Auto	BIOS will automatically detect the IDE HDD Accessing mode.
	Disable UDMA function.

- **USB Controller**

Enabled	Enable USB Controller. (Default value)
Disabled	Disable USB Controller.

- **USB Keyboard Support**

Enabled	Enable USB Keyboard Support.
Disabled	Disable USB Keyboard Support. (Default value)

- **Init Display First**

PCI Slot	Set Init Display First to PCI Slot. (Default value)
Onboard	Set Init Display First to onboard AGP.

-

Auto	Set AC'97 Audio to Auto. (Default value)
Enabled	Enabled AC'97 Audio.
	Disabled AC'97 Audio.

- **AC'97 Modem**

Auto	Set AC'97 Modem to Auto. (Default value)
Enabled	Enabled AC'97 Modem.
Disabled	Disabled AC'97 Modem.

- **IDE HDD Block Mode**

Enabled	Enable IDE HDD Block Mode. (Default value)
Disabled	Disable IDE HDD Block Mode.

- **POWER ON Function**

Password	Enter from 1 to 5 characters to set the Keyboard Power On Password.
Mouse Left	Double click twice on PS/2 left bottom.
	Double click twice on PS/2 right bottom.
BUTTON ONLY	If your keyboard have "POWER Key" button, you can press the key to power on your system. (Default value)
Keyboard 98	Windows 98 keyboard "Power" key.

- **Onboard FDC Controller**

Enabled	Enable onboard FDC port. (Default value)
Disabled	Disable onboard FDC port.

- **Onboard Serial Port 1**

Auto	BIOS will automatically setup the port 1 address. (Default value)
3F8/IRQ4	Enable onboard Serial port 1 and address is 3F8.
2F8/IRQ3	Enable onboard Serial port 1 and address is 2F8.
3E8/IRQ4	
2E8/IRQ3	Enable onboard Serial port 1 and address is 2E8.
Disabled	Disable onboard Serial port 1.

-

Auto	BIOS will automatically setup the port 2 address. (Default value)
3F8/IRQ4	Enable onboard Serial port 2 and address is 3F8.
2F8/IRQ3	Enable onboard Serial port 2 and address is 2F8.
	Enable onboard Serial port 2 and address is 3E8.
2E8/IRQ3	Enable onboard Serial port 2 and address is 2E8.
Disabled	Disable onboard Serial port 2.

- **UART Mode Select**

(This item allows you to determine which Infra Red(IR) function of Onboard I/O chip)

	Onboard I/O chip supports ASKIR.
IrDA	Onboard I/O chip supports IrDA.
	Onboard I/O chip supports Normal.

- **RxD , TxD Active**

Hi, Hi	RxD set Hi, TxD set Hi.
Hi, Lo	RxD set Hi, TxD set Lo. (Default value)
Lo, Hi	RxD set Lo, TxD set Hi.
Lo, Lo	RxD set Lo, TxD set Lo.

- **IR Transmittiion delay**

Enabled	Set IR Transmittiion delay Enabled. (Default value)
Disabled	Set IR Transmittiion delay Disabled.

- **Onboard Parallel port**

378/IRQ7	Enable onboard LPT port and address is 378/IRQ7. (Default value)
278/IRQ5	Enable onboard LPT port and address is 278/IRQ5.
Disabled	Disable onboard LPT port.
3BC/IRQ7	Enable onboard LPT port and address is 3BC/IRQ7.

- **Parallel Port Mode**

SPP	Using Parallel port as Standard Parallel Port. (Default value)
EPP	Using Parallel port as Enhanced Parallel Port.
ECP	Using Parallel port as Extended Capabilities Port.
ECP+EPP	Using Parallel port as ECP & EPP mode.

- **EPP Mode Select**

EPP 1.9	EPP Version is 1.9.
EPP 1.7	EPP Version is 1.7. (Default value)

- **ECP Mode Use DMA**

1	Set ECP Mode Use DMA is 1.
3	Set ECP Mode Use DMA is 3. (Default value)

- **Game Port Address**

Disabled	Disabled On Board Game Port.
201	Set onboard game port is 201. (Default value)
209	Set onboard game port is 209.

- **Midi Port Address**

	Disabled On Board Midi Port.
300	
330	Set On Board Midi Port is 330. (Default value)

- **Midi Port IRQ**

5	
	Set 10 for Midi Port IRQ.

Power Management Setup

CMOS Setup Utility-Copyright(C) 1984-1999 Award Software Power Management Setup		
ACPI Suspend Type	S1(PowerOn Suspend)	
Power Management	User Define	
Video Off Method		Menu Level ▶
Video Off In Suspend	Yes	
MODE		
Suspend Mode	Disabled	
Soft Off by PWR BTTN	Instant off	
AC BACK Function	Memory	
-		
ModemRingOn/WakeOnLan	Enabled	
USB KB/M		
CPU Thermal Throttling	50%	
* Date(of Month) Alarm	0	
Primary IDE 1	Disabled	
Secondary IDE 1	Disabled	
PCI PIRQ[A D]#	Enabled	

↑↓→ ←:Move Enter:Select +/-PU/PD:Value F10:Save ESC:Exit F1:General Help
F5:Previous Values F6:Fail-Safe Defaults F7:Optimized Defaults

Figure 7: Power Management Setup

- **ACPI Suspend Type**

S1(PowerOn Suspend)	Set ACPI Suspend type is S1. (Default value)
S3(Suspend to RAM)	Set ACPI Suspend type is S3.

- **Power Management**

User Define	For configuring our own power management features. (Default value)
Min Saving	Enable Green function.
Max Saving	Disable Green function.

- **Video off Method**

V/H SYNC+Blank	BIOS will turn off V/H-SYNC when gets into Green mode for Green monitor power saving.
Blank Screen	BIOS will only black monitor when gets into Green mode.
DPMS	BIOS will use DPMS Standard to control VGA card. (The Green type VGA card will turn off V/H-SYNC automatically.) (Default value)

- **Video Off In Suspend**

Yes	Enabled video off in suspend. (Default value)
No	Disabled video off in suspend.

- **Suspend Type**

	Set Suspend type is stop grant.
	Set Suspend type is Power on suspend.

- **MODEM Use IRQ**

NA	Set MODEM Use IRQ to NA..
3	Set MODEM Use IRQ to 3.
4	Set MODEM Use IRQ to 4. (Default value)
5	Set MODEM Use IRQ to 5.
	Set MODEM Use IRQ to 7.
9	Set MODEM Use IRQ to 9.
10	
11	Set MODEM Use IRQ to 11.

- **Suspend Mode**

	Disable Suspend Mode.
1 min - 1 Hour	Setup the timer to enter Suspend Mode.

- **HDD Power Down**

Disabled	Disable HDD Power Down mode function. (Default value)
1-15 mins.	Enable HDD Power Down mode between 1 to 15 mins.

- **Soft-off by PWR-BTTN (Instant-off)**

Instant-off	Soft switch ON/OFF for POWER ON/OFF. (Default value)
Delay 4 Sec.	Soft switch ON 4sec. for POWER OFF.

- **Power LED in Suspend**

Blinking	Set Power LED in Suspend at Blinking mode. (Default value)
On	Set Power LED in Suspend at On mode.
Off/Dual	Set Power LED in Suspend at Off/Dual color mode.

- **AC Back Function**

Memory	This function depends on computer status. (Default value)
Soft-Off	Set System Soft-Off Status.
Full-On	Set System Full-On Status.

- **Wake-Up by PCI card**

Disabled	Disabled this function.
Enabled	Enabled wake-up by PCI card. (Default value)

- **ModemRingOn / WakeOnLan**

Disabled	Disable these functions.
Enabled	Enable these functions. (Default value)

- **FAN Off In Suspend**

Disabled	Disable this function.
Enabled	Stop CPU FAN when entering Suspend mode. (Default value)

Disabled	Disabled this function. (Default value)
Enabled	Enabled USB KB/Mouse Wake From S3 function.

• **CPU Thermal Throttling**

	Monitor CPU Temp. will cause system slow down CPU Duty Cycle to
75.0%	Monitor CPU Temp. will cause system slow down CPU Duty Cycle to 75.0%.
62.5%	mp. will cause system slow down CPU Duty Cycle to 62.5%.
	Monitor CPU Temp. will cause system slow down CPU Duty Cycle to (Default value)
37.5%	Monitor CPU Temp. will cause system slow down CPU Duty Cycle to 37.5%.
25.0%	emp. will cause system slow down CPU Duty Cycle to 25.0%.
	Monitor CPU Temp. will cause system slow down CPU Duty Cycle to

• **Resume by Alarm**

Disabled	Disable this function. (Default value)
Enabled	Enable alarm function to POWER ON system.

If the default value is Enabled.

Date (of Month) Alarm :	0~31
Time (hh: mm: ss) Alarm :	(0~23) : (0~59) : (0~59)

• **Primary IDE 0/1**

Disabled	(Default value)
Enabled	

• **Secondary IDE 0/1**

Disabled	Disable this function. (Default value)
Enabled	Enable monitor Secondary IDE 0/1 for Green event.

• **FDD/COM/LPT Port**

Disabled	Disable this function.
Enabled	Enable monitor FDC/COM/LPT for Green event. (Default value)

• **PCI PIRQ[A-**

Enabled	Monitor PCI PIRQ[A- (Default value)
Disabled	IRQ[A-

PnP/PCI Configurations

CMOS Setup Utility-Copyright(C) 1984-1999 Award Software
PnP/PCI Configurations

PNP OS Installed	No	Item Help
Reset Configuration Data	Disabled	
Resources Controlled By	Auto (ESCD)	Menu Level ▶
* IRQ Resources	Press Enter	
*DMA Resources	Press Enter	
*Memory Resources	Press Enter	
PCI/VGA Palette Snoop	Disabled	Select Yes if you Are using a Plug And Play capable Operating system Select No if you Need the BIOS to Configure non- Boot devices

↑↓→ ← Move Enter:Select +/-PU/PD:Value F10:Save ESC:Exit F1:General Help
 F5:Previous Values F6:Fail-Safe Defaults F7:Optimized Defaults

Figure 8: PnP/PCI Configuration

• **PNP OS Installed**

	Enable PNP OS Installed function.
No	Disable PNP OS Installed function. (Default value)

- **Reset Configuration Data**

Disabled	Disable this function. (Default value)
ESCD	Clear PnP information in ESCD.
	Update Desktop Management Information data.
Both	Clear PnP information in ESCD & update DMI data.

- **Resources Controlled by**

Manual	User can set the PnP resource (I/O Address, IRQ & DMA channels) used by legacy ISA DEVICE.
Auto(ESCD)	BIOS automatically use these PnP rescuers. (Default value)

- **,12,14,15),DMA(0,1,3,5,6,7) assigned to Legacy ISA or "PCI/ISA PnP)**

Legacy ISA	
	The resource is used by PCI/ISA PnP device (PCI or ISA).

- **Reserved Memory Base**

N/A	(Default value)
C800 ~ DC00	

- **PCI/VGA Palette Snoop**

Enabled	For having Video Card on ISA Bus and VGA Card on PCI Bus.
Disabled	For VGA Card only. (Default value)

PC Health Status

CMOS Setup Utility-Copyright(C) 1984-1999 Award Software		
PC Health Status		
		Item Help
Reset Case Open Status	Disabled	
Case Opened	Yes	
Current CPU Temperature	47°C/116°F	
CPU FAN Speed	4891 RPM	
Power FAN Speed	0 RPM	
System FAN Speed	0 RPM	
VCORE	2.08 V	
VGTL	1.50 V	
VCC3	3.45 V	
+ 5V	5.10 V	
+12V	12.28 V	
- 12V	-12.52 V	
- 5V	- 5.09 V	
VBAT	3.13 V	
5VSB	5.33 V	
CPU Warning Temperature	70°C/158°F	
Shutdown Temperature	75°C/167°F	
CPU FAN Fail Alarm	Disabled	
Power FAN Fail Alarm	Disabled	
System FAN Fail Alarm	Disabled	

↑↓→←:Move Enter:Select +/-PU/PD:Value F10:Save ESC:Exit F1:General Help
F5:Previous Values F6:Fail-Safe Defaults F7:Optimized Defaults

Figure 9: PC Health Status

- **Reset Case Open Status**

- **Case Opened**

If the case is closed, "Case Opened" will show "No".

If the case have been opened, "Case Opened" will show "Yes".

If you want to reset "Case Opened" value, set "Reset Case Open Status" to "Enabled" and save CMOS, your computer will restart.

- **Current CPU Temperature (°C / °F)**

Detect CPU Temp. automatically.

-
- - ± ±
 - ° °

70°C / 158°F	Monitor CPU Temp. at 70°C / 158°F. (Default value)
75°C / 167°F	Monitor CPU Temp. at 75°C / 167°F.
Disabled	Disabled this function.

- **Shutdown Temp. (°C / °F)**

(This function will be effective only for the operating systems that support ACPI Function.)

Disabled	Normal Operation
65°C / 149°F	Monitor CPU Temp. at 65°C / 149°F, if Temp. > 65°C / 149°F system will automatically power off .
70°C / 158°F	Monitor CPU Temp. at 70°C / 158°F, if Temp. > 70°C / 158°F system will automatically power off .
75°C / 167°F	Monitor CPU Temp. at 75°C / 167°F, if Temp. > 75°C / 167°F system will automatically power off . (Default value)

- **Fan Fail Alarm**

CPU / Power / System

Disabled	Fan Fail Alarm Function Disabled. (Default value)
Enabled	Fan Fail Alarm Function Enabled.

Frequency/Voltage Control

CMOS Setup Utility-Copyright(C) 1984-1999 Award Software
Frequency/Voltage Control

Auto Detect DIMM/PCI Clk	Enabled	Item Help
Spread Spectrum	Disabled	
CPU Type CELERON(TM)	200	Menu Level ▶

↑↓→← Move Enter: Select +/-PU/PD: Value F10: Save ESC: Exit F1: General Help
F5: Previous Values F6: Fail-Safe Defaults F7: Optimized Defaults

Figure 10: Frequency/Voltage Control

- Auto Detect DIMM/PCI Clk**

Disabled	Disabled Auto Detect DIMM/PCI Clk.
Enabled	Enabled Auto Detect DIMM/PCI Clk. (Default value)

- Spread Spectrum**

Disabled	Disabled this function. (Default value)
0.25% (Cntr)	Set Spread Spectrum to 0.25%(Center spread).
0.50%(Down)	Set Spread Spectrum to 0.50%(Down spread).

- CPU Type CELERON(TM)**

1. System Bus Speed : 66MHz

200 / 233 / 266 / 300 / 333 / 366 / 400 / 433 / 466 / 500 / 533

2. System Bus Speed : 100MHz

300 / 350 / 400 / 450 / 500 / 550 / 600 / 650 / 700 / 750 / 800

3. System Bus Speed : 133MHz

400 / 466 / 533 / 600 / 666 / 733 / 800 / 866 / 933 / 1000 / 1066

Load Fail-Safe Defaults

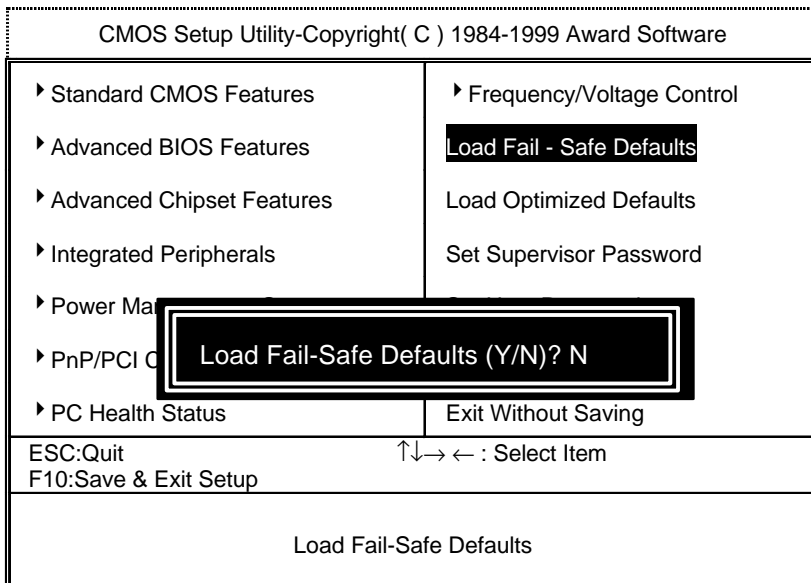

Figure 11: Load Fail-Safe Defaults

- **Load Fail-Safe Defaults**

Fail-Safe defaults contain the most appropriate values of the system parameters that allow minimum system performance.

Load Optimized Defaults

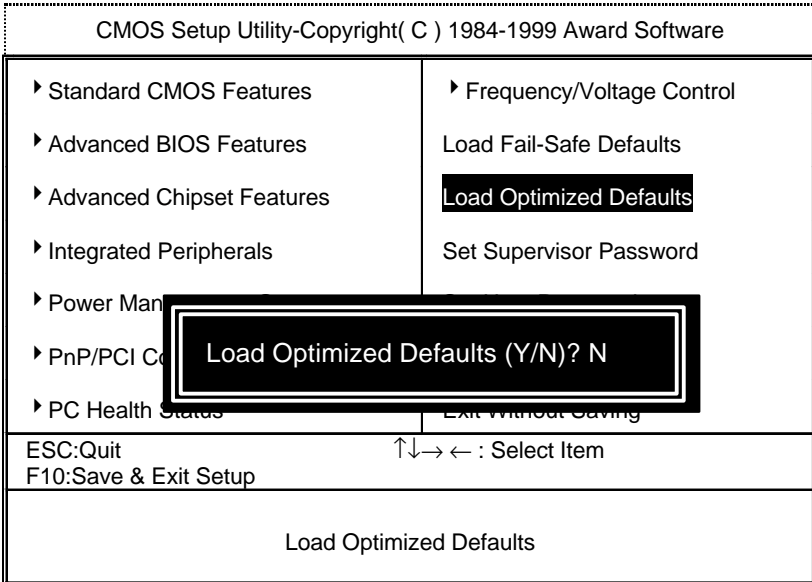

Figure 12: Load Optimized Defaults

- **Load Optimized Defaults**

Selecting this field loads the factory defaults for BIOS and Chipset Features which the system automatically detects.

Set Supervisor / User Password

When you select this function, the following message will appear at the center of the screen to assist you in creating a password.

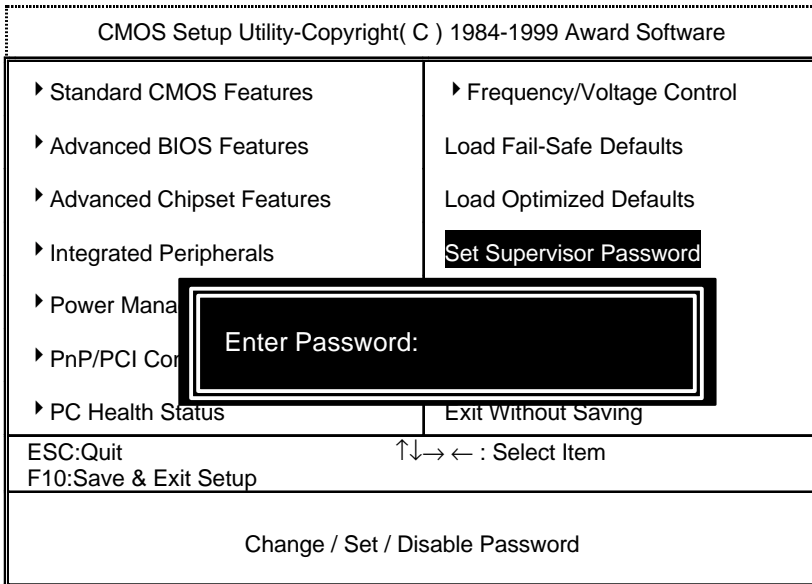

Figure 13: Password Setting

Type the password, up to eight characters, and press <Enter>. The password typed now will clear the previously entered password from CMOS memory. You will be asked to confirm the password. Type the password again and press <Enter>. You may also press <Esc> to abort the selection and not enter a password.

To disable password, just press <Enter> when you are prompted to enter password. A message "PASSWORD DISABLED" will appear to confirm the password being disabled. Once the password is disabled, the system will boot and you can enter Setup freely.

If you select System at Security Option in BIOS Features Setup Menu, you will be prompted for the password every time the system is rebooted or any time you try to enter Setup Menu. If you select Setup at Security Option in BIOS Features Setup Menu, you will be prompted only when you try to enter Setup.

Save & Exit Setup

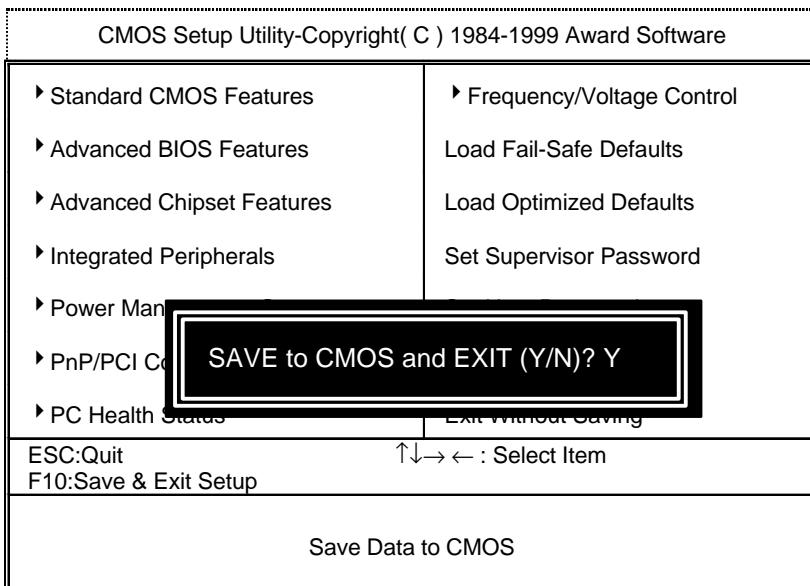

Figure 14: Save & Exit Setup

Type "Y" will quit the Setup Utility and save the user setup value to RTC CMOS.

Type "N" will return to Setup Utility.

Exit Without Saving

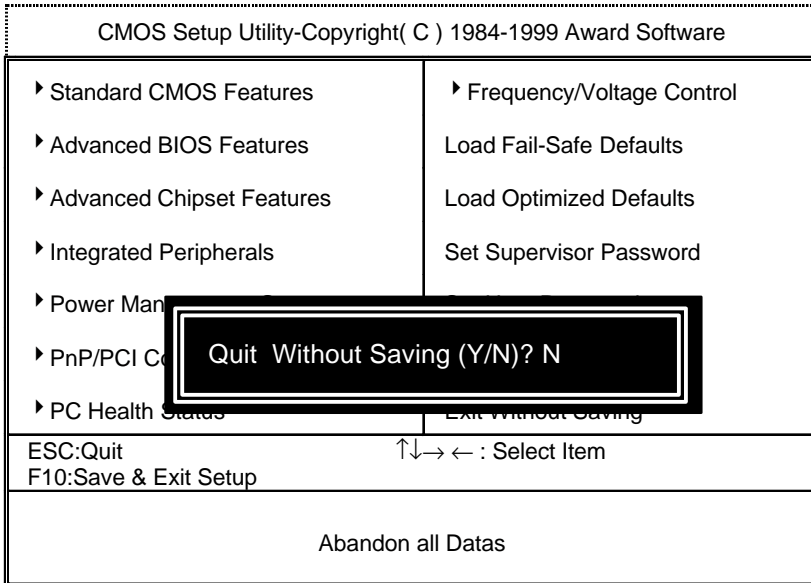

Figure 15: Exit Without Saving

Type "Y" will quit the Setup Utility without saving to RTC CMOS.

Type "N" will return to Setup Utility.

Appendix

Appendix A : Onboard Driver Installation Procedure

(In this manual, we assume that your CD-ROM Drive letter to be Drive D:)
Please reference IUCD CD directory D: \ Manual \ Whitney 810.pdf

Appendix B : 810 INF update utility can't find ICHxIDE.cat file automatically

1. After the installation of Windows 98 is completed, run the Setup.exe of INF update utility.
2. System restarts.
3. System starts to recognize every new component.
4. System will stop and prompt users to specify the location of ICHxIDE.cat file.
5. The system will not find the location of ICHxIDE.cat automatically.

Resolution:

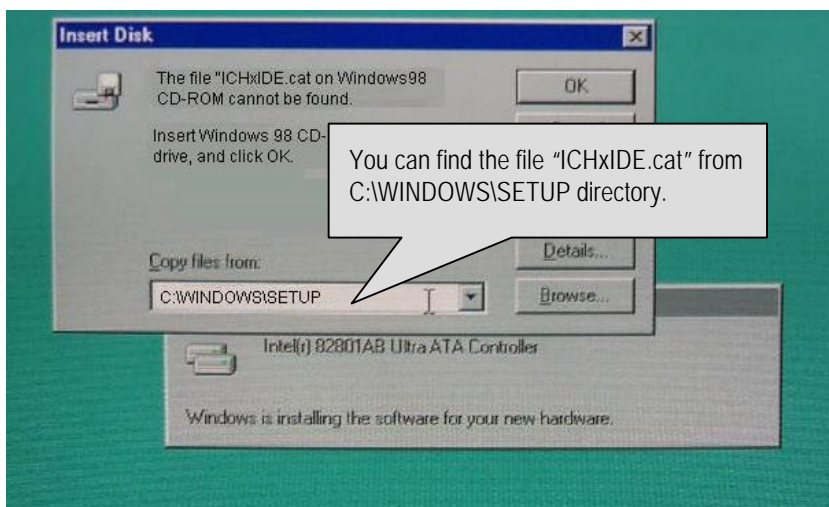

Appendix C : BIOS Flash Procedure

BIOS update procedure:

- ✓ Please check your BIOS vendor (AMI or AWARD) on the motherboard.
- ✓ It is recommended you copy the AWDFlash.exe or AMIFlash.exe in driver CD (D:\>Utility\BIOSFlash) and the BIOS binary files into the directory you made in your hard disk. `ie:C:\>Utility\ (C:\>Utility : denotes the driver and the directory where you put the flash utilities and BIOS file in.)`
- ✓ Restart your computer into MS-DOS mode or command prompt only for Win95/98, go into the directory where the new BIOS file are located use the utility AWDFlash.exe or AMIFlash.exe to update the BIOS.
- ✓ Type the following command once you have enter the directory where all the files are located
`C:\utility\ AWDFlash or AMIFlash <filename of the BIOS binary file intended for flashing>`
- ✓ Once the process is finished, reboot the system

●Note : Please download the newest BIOS from our website (www.gigabyte.com.tw) or contact your local dealer for the file.

Appendix D : Acronyms

Acro.	Meaning	Acro.	Meaning	Acro.	Meaning
ACPI	Advanced configuration and power interface	ECC	Error checking and correcting	IRQ	Interrupt request
POST	Power-on self test	IDE	Integrated dual channel enhanced	NIC	Network interface card
LAN	Local area network	SCI	Special circumstance instructions	A.G.P.	Accelerated graphics port
ECP	Extended capabilities port	LBA	Logical block addressing	S.E.C.C	Single edge contact cartridge
APM	Advanced power management	EMC	Electromagnetic compatibility	LED	Light emitting diode
DMA	Direct memory access	BIOS	Basic input / output system	EPP	Enhanced parallel port
MHz	Megahertz	SMI	System management interrupt	CMOS	Complementary metal oxide semiconductor
ESCD	Extended system configuration data	I/O	Input / Output	DMI	Desktop Management Interface
CPU	Central processing unit	ESD	Electrostatic DISCHARGE	MIDI	Musical interface digital interface
SMP	Symmetric multi-processing	OEM	Original equipment manufacturer	IOAPIC	Input Output Advanced Programmable Input Controller
USB	Universal serial bus	SRAM	Static random access memory	DIMM	Dual inline memory module
OS	Operating System	VID	Voltage ID	DRAM	Dynamic random access memory
					To be continued

Acro.	Meaning	Acro.	Meaning	Acro.	Meaning
DRM	Dual retention mechanism	PAC	<u>P</u> CI <u>A</u> .G.P. <u>c</u> ontroller	PCI	Peripheral component interconnect
ISA	Industry standard architecture	AMR	Audio Modem Riser	RIMM	Rambus In-line Memory Midule
CRIMM	Continuity RIMM				