

## FCC Compliance Statement:

<p align="center"><b>DECLARATION OF CONFORMITY</b> Per FCC Part 2 Section 2.107(a)</p> <p align="center"><b>FC</b></p> <p>Responsible Party Name: G.B.T. INC.</p> <p align="center">Address: 18365 Valley Blvd., Suite#A LA Puente, CA 91744</p> <p align="center">Phone/Fax No: (818) 854-9338 / (818) 854-9339</p> <p>hereby declares that the product</p> <p>Product Name: Mother Board</p> <p>Model Number: GA-60XM7</p> <p>Conforms to the following specifications:</p> <p>FCC Part 15, Subpart B, Section 15.107(a) and Section 15.109(a), Class B Digital Device.</p> <p><b>Supplementary Information:</b></p> <p><small>This device complies with part 15 of the FCC Rules. Operation is subject to the following two conditions: (1) This device may not cause harmful and (2) this device must accept any interference received, including that may cause undesired operation.</small></p> <p>Representative Person's Name: <u>ERIC LU</u></p> <p>Signature: <u>Eric Lu</u></p> <p>Date: <u>Jun 13, 2000</u></p>
---

This equipment has been tested and found to comply with limits for a Class B digital device, pursuant to Part 15 of the FCC rules. These limits are designed to provide reasonable protection against harmful interference in residential installations. This equipment generates, uses, and can radiate radio frequency energy, and if not installed and used in accordance with the instructions, may cause harmful interference to radio communications. However, there is no guarantee that interference will not occur in a particular installation. If this equipment does cause interference to radio or television equipment reception, which can be

determined by turning the equipment off and on, the user is encouraged to try to correct the interference by one or more of the following measures:

- Reorient or relocate the receiving antenna
- Move the equipment away from the receiver
- Plug the equipment into an outlet on a circuit different from that to which the receiver is connected
- Consult the dealer or an experienced radio/television technician for additional suggestions

You are cautioned that any change or modifications to the equipment not expressly approve by the party responsible for compliance could void Your authority to operate such equipment.

This device complies with Part 15 of the FCC Rules. Operation is subjected to the following two conditions 1) this device may not cause harmful interference and 2) this device must accept any interference received, including interference that may cause undesired operation.

# Declaration of Conformity

We, Manufacturer/Importer  
(full address)

**G.B.T. Technology Trading GmbH**  
**Ausschlagler Weg 41, 1F, 20537 Hamburg, Germany**

declare that the product  
( description of the apparatus, system, installation to which it refers)

**Mother Board**  
GA-6OXM7

is in conformity with  
(reference to the specification under which conformity is declared)  
in accordance with 89/336 EEC-EMC Directive

- |   |  |  |  |
|---|--|--|--|
| <input type="checkbox"/> EN 55011   | Limits and methods of measurement of radio disturbance characteristics of industrial, scientific and medical (ISM high frequency equipment                 | <input checked="" type="checkbox"/> EN 61000-3-2*<br><input checked="" type="checkbox"/> EN60555-2 | Disturbances in supply systems caused by household appliances and similar electrical equipment "Harmonics"   |
| <input type="checkbox"/> EN55013  | Limits and methods of measurement of radio disturbance characteristics of broadcast receivers and associated equipment                                     | <input type="checkbox"/> EN61000-3-3*<br><input checked="" type="checkbox"/> EN60555-3             | Disturbances in supply systems caused by household appliances and similar electrical equipment "Voltage fluctuations"                                  |
| <input type="checkbox"/> EN 55014   | Limits and methods of measurement of radio disturbance characteristics of household electrical appliances, portable tools and similar electrical apparatus | <input checked="" type="checkbox"/> EN 50081-1<br><input checked="" type="checkbox"/> EN 50082-1   | Generic emission standard Part 1: Residual, commercial and light industry<br>Generic immunity standard Part 1: Residual, commercial and light industry |
| <input type="checkbox"/> EN 55015   | Limits and methods of measurement of radio disturbance characteristics of fluorescent lamps and luminaries   | <input type="checkbox"/> EN 55081-2  | Generic emission standard Part 2: Industrial environment   |
| <input type="checkbox"/> EN 55020   | Immunity from radio interference of broadcast receivers and associated equipment   | <input type="checkbox"/> EN 55082-2  | Generic immunity standard Part 2: Industrial environment   |
| <input checked="" type="checkbox"/> EN 55022  | Limits and methods of measurement of radio disturbance characteristics of information technology equipment   | <input type="checkbox"/> ENV 55104   | Immunity requirements for household appliances tools and similar apparatus   |
| <input type="checkbox"/> DIN VDE 0855<br><input type="checkbox"/> part 10<br><input type="checkbox"/> part 12 | Cabled distribution systems; Equipment for receiving and/or <b>distribution</b> from sound and television signals  | <input type="checkbox"/> EN 50091- 2   | EMC requirements for uninterruptible power systems (UPS)   |
| <input checked="" type="checkbox"/> CE marking  |  |                 | (EC conformity marking)  |

**The manufacturer also declares the conformity of above mentioned product with the actual required safety standards in accordance with LVD 73/23 EEC**

- |                                   |   |                                     |   |
|-----------------------------------|---|-------------------------------------|---|
| <input type="checkbox"/> EN 60065 | Safety requirements for mains operated electronic and related apparatus for household and similar general use | <input type="checkbox"/> EN 60950   | Safety for information technology equipment including electrical business equipment |
| <input type="checkbox"/> EN 60335 | Safety of household and similar electrical appliances   | <input type="checkbox"/> EN 50091-1 | General and Safety requirements for uninterruptible power systems (UPS)             |

Manufacturer/Importer

Signature : Rex Lin  
Name : Rex Lin

(Stamp)

Date: Jun. 13, 2000

**60XM7 Series**  
**Socket 370 Processor Motherboard**

**USER'S MANUAL**

Socket 370 Processor Motherboard  
REV. 2.0 Second Edition  
R-20-02-001127



## How This Manual Is Organized

This manual is divided into the following sections:

<b>1) Revision History</b>	Manual revision information
<b>2) Item Checklist</b>	Product item list
<b>3) Features</b>	Product information & specification
<b>4) Hardware Setup</b>	Instructions on setting up the motherboard
<b>5) Performance &amp; Block Diagram</b>	Product performance & block diagram
<b>6) Suspend to RAM</b>	Instructions STR installation
<b>7) Four Speaker &amp; SPDIF</b>	Four Speaker & SPDIF introduction
<b>8) @BIOS™ &amp; EasyTuneIII™</b>	@BIOS™ & EasyTuneIII™ introduction
<b>9) BIOS Setup</b>	Instructions on setting up the BIOS software
<b>10) Appendix</b>	General reference



## Table Of Content

Revision History	P.1
Item Checklist	P.2
Summary of Features	P.3
60XM7 Series Motherboard Layout	P.5
Page Index for CPU Speed Setup/Connectors/Panel and Jumper Definition	P.6
Performance List	P.31
Block Diagram	P.32
Suspend to RAM Installation (Optional)	P.33
Introduce Dual BIOS (Optional)	P.39
Four Speaker & SPDIF Introduction (Optional)	P.46
@BIOS™ Introduction	P.51
EasyTuneIII™ Introduction	P.52
Memory Installation	P.54
Page Index for BIOS Setup	P.55
Appendix	P.93

## Revision History

Revision	Revision Note	Date
1.2	Initial release of the 6OXM7 Series motherboard user's manual.	May.2000
1.2	Second release of the 6OXM7 Series motherboard user's manual.	Jun.2000
1.2	Third release of the 6OXM7 Series motherboard user's manual.	Jun.2000
1.2	Fourth release of the 6OXM7 Series motherboard user's manual.	Jul.2000
2.0	Initial release of the 6OXM7 Series motherboard user's manual.	Aug.2000
2.0	Second release of the 6OXM7 Series motherboard user's manual.	Nov.2000

The author assumes no responsibility for any errors or omissions that may appear in this document nor does the author make a commitment to update the information contained herein.

Third-party brands and names are the property of their respective owners.



---

## Item Checklist

- The 60XM7 Series motherboard
- Cable for IDE / floppy device
- Diskettes or CD (IUCD) for motherboard driver & utility
- 60XM7 Series user's manual

## Summary Of Features

Form Factor	<ul style="list-style-type: none"> <li>30.5 cm x 21.5 cm ATX Size form factor, 4 layers PCB.</li> </ul>
CPU	<ul style="list-style-type: none"> <li>Socket 370 processor           <ul style="list-style-type: none"> <li>Intel Pentium® III 100/133MHz FSB, FC-PGA</li> <li>Intel Celeron™ 66MHz FSB, FC-PGA</li> </ul> </li> <li>2nd cache in CPU (Depend on CPU)</li> </ul>
Chipset	<ul style="list-style-type: none"> <li>Intel 815 HOST / AGP / SDRAM Controller</li> <li>82801AA I/O Controller Hub (ICH)</li> </ul>
Clock Generator	<ul style="list-style-type: none"> <li>ICS 9250-25</li> <li>66/100/133 MHz system bus speeds</li> </ul>
Memory	<ul style="list-style-type: none"> <li>4 168-pin DIMM sockets (DIMM 4 is optional)</li> <li>Supports PC-100 / PC-133 SDRAM</li> <li>Supports up to 512MB(Max)</li> <li>Supports only 3.3V SDRAM DIMM</li> </ul>
I/O Control	<ul style="list-style-type: none"> <li>IT8712</li> </ul>
Slots	<ul style="list-style-type: none"> <li>1 AGP Slot Supports 4X mode &amp; AGP 2.0 compliant</li> <li>1 DFP /TV</li> <li>6 PCI Slot Supports 33MHz &amp; PCI 2.2 compliant</li> <li>1 AMR (Audio Modem Riser)Slot</li> </ul>
On-Board IDE	<ul style="list-style-type: none"> <li>Supports PIO mode 3, 4, UDMA33/ATA66 IDE &amp; ATAPI CD-ROM</li> <li>2 IDE bus master (UDMA 33/ ATA 66) IDE ports for up to 4 ATAPI devices</li> </ul>
On-Board Peripherals	<ul style="list-style-type: none"> <li>1 floppy port supports 2 FDD with 360K, 720K, 1.2M, 1.44M and 2.88M bytes</li> <li>1 parallel ports supports SPP/EPP/ECP mode</li> <li>2 serial ports (COM A &amp; COM B)</li> <li>2 USB ports</li> <li>1 IrDA connector for IR/CIR</li> </ul>
Hardware Monitor	<ul style="list-style-type: none"> <li>CPU/Power Supply/System fan revolution detect</li> <li>CPU temperature detect</li> <li>System voltage detect</li> <li>CPU overheat shutdown detect</li> </ul>

To be continued...

---

Summary of Features

On-Board Sound	<ul style="list-style-type: none"><li>• Creative CT5880 sound (Optional)</li><li>• AC'97 CODEC</li><li>• Line In / Line Out / Mic In / AUX In / CD In / TEL / SPDIF(Optional) /Game Port / Four Speaker(Optional)</li></ul>
PS/2 Connector	<ul style="list-style-type: none"><li>• PS/2 keyboard interface and PS/2 mouse interface</li></ul>
BIOS	<ul style="list-style-type: none"><li>• Licensed AWARD BIOS, 4M bit flash ROM</li><li>• Support Dual BIOS (Optional)</li></ul>
Additional Features	<ul style="list-style-type: none"><li>• Supports Wake-on-LAN (WOL)</li><li>• Supports Internal / External modem wake up</li><li>• Includes 3 fan power connectors</li><li>• Poly fuse for keyboard over-current protection</li><li>• Support @BIOS™ and EasyTuneIII™</li></ul>

# 60XM7 Series Motherboard Layout

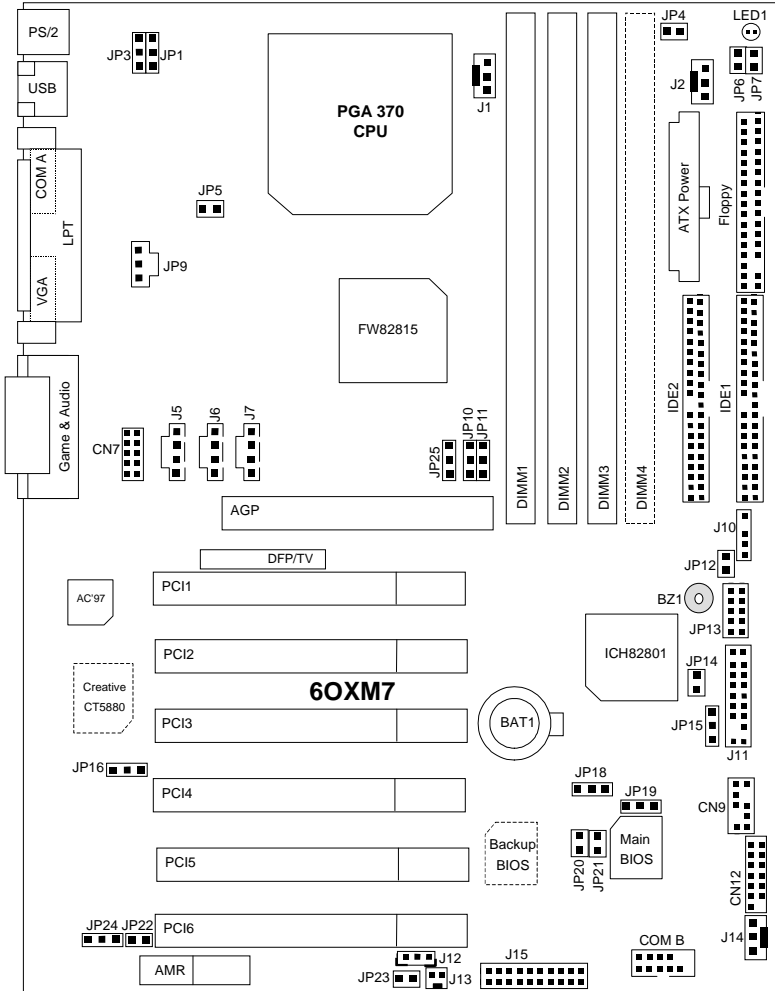

 Page Index for CPU Speed Setup/Connectors/Panel and Jumper Definition	Page
CPU Speed Setup	P.8
Connectors	P.9
Game & Audio Port	P.9
COM A / COM B / VGA / LPT Port	P.9
USB Connector	P.10
PS/2 Keyboard & PS/2 Mouse Connector	P.10
J1 (CPU Fan)	P.11
J2 (Power Fan)	P.11
J14 (System Fan)	P.12
ATX Power	P.12
JP13 (IR/CIR)	P.13
Floppy Port	P.13
IDE 1(Primary)/ IDE 2(Secondary) Port	P.14
J13 (Ring Power On)	P.14
J12 (Wake on LAN)	P.15
J7 (TEL)	P.15
J6 (AUX_IN)	P.16
J5 (CD Audio Line In)	P.16
JP9 (SPDIF) [Optional]	P.17
JP7 (STR LED Connector) & LED 1 (DIMM LED) [Optional]	P.17
CN9 (Front USB Port) [Optional]	P.18
J10 (Extra SMBUS)	P.18
CN7 (Front Audio) [Optional]	P.19
CN8 (DFP/TV Out Connector)	P.19
J15 (IA Port) [Optional]	P.20
CN12 (SCR)	P.20
Panel and Jumper Definition	P.21
J11 (2x11 Pins Jumper)	P.21
JP18 (Clear CMOS Function)	P.22
JP4 (STR Enable) [Optional]	P.22
JP16 (Onboard Sound Function Selection) [Optional]	P.23
JP3 (PS/2 Keyboard Power On)	P.23
JP1 (Rear USB Device Wake up Selection)	P.24
JP22 (Case Open)	P.24
JP20 (FWH Flash Write Protection)	P.25
JP21 (Top Block Lock)	P.25
JP5 (Over Voltage CPU Speed up)	P.26

## 6OXM7 Series Motherboard

---

JP6 (DIMM Over Voltage) [Optional]	P.26
JP12 (Internal Buzzer Connector) [Optional]	P.27
JP14 (Timeout Reboot Function)	P.27
JP15 (Safe mode / Recovery / Normal)	P.28
JP19 (Front USB Device Wake up Selection) [Optional]	P.28
JP23 (PCI/AGP 3VAUX)	P.29
JP24 (AMR Selection) [Optional]	P.29
BAT1 (Battery)	P.30

## CPU Speed Setup

The system bus frequency can be switched at 66MHz, 100MHz, 133MHz and Auto by adjusting JP10/JP11/JP25 (See Figure 1). The CPU Frequency is control by BIOS.

⚡\* The CPU speed must match with the frequency RATIO. It will cause system hanging up if the frequency RATIO is higher than that of CPU.

JP10/JP11/JP25: CPU Speed Setup (Optional)

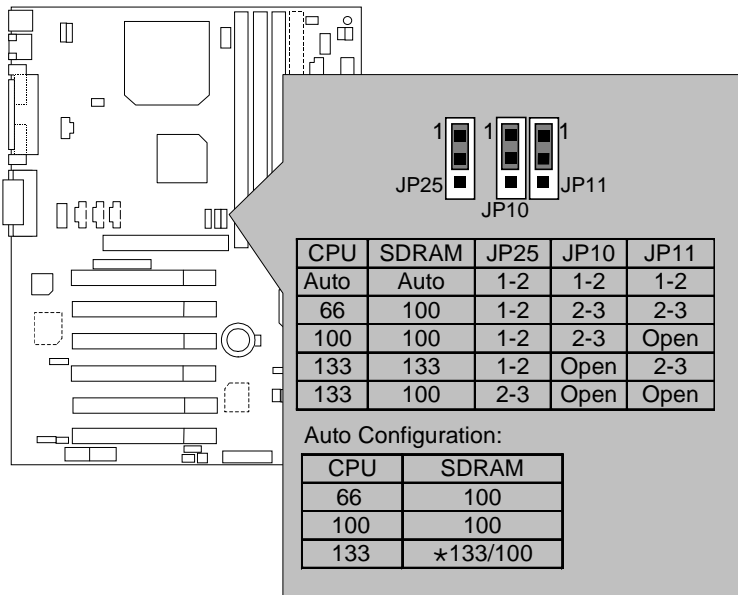

Figure 1

★ If the CPU FSB is 133 FSB, the frequency of the SDRAM can be determined by SDRAM's SPD or setting in BIOS.

⚡\* If JP10, JP11, JP25 is not present, FSB will be determined automatically. If these 3 jumpers are available, you can choose at 66MHz, 100MHz, 133MHz and Auto.

⚡\*Note: Please set the CPU host frequency in accordance with your processor's specifications. We don't recommend you to set the system bus frequency over the CPU's specification because these specific bus frequencies are not the standard specifications for CPU, chipset and most of the peripherals. Whether your system can run under these specific bus frequencies properly will depend on your hardware configurations, including CPU, Chipsets, SDRAM, Cards....etc.

# Connectors

## Game & Audio Port

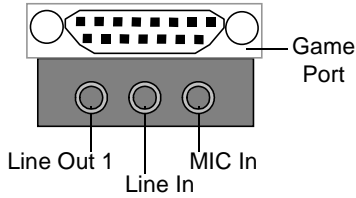
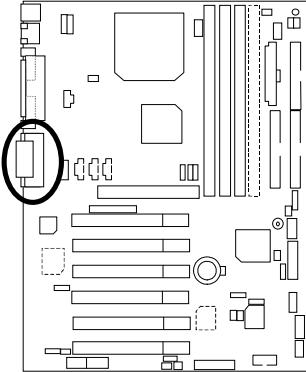

Line Out 1: Line Out or SPDIF (The SPDIF output is capable of providing digital audio to external speakers or compressed AC3 data to an external Dolby digital decoder). In general, Line Out 1 is normally Line Out, when it output digital signal, it will be change to SPDIF Out automatically (see page 48 for more information). Line In: In general, Line In is normally Line In. When you select "Four Speaker" in Creative application (see page 46 for more information), Line In will be change to Line Out 2, then you can plug 2 pairs stereo speaker into Line Out 1 and Line In simultaneously.

## COM A / COM B / VGA / LPT Port

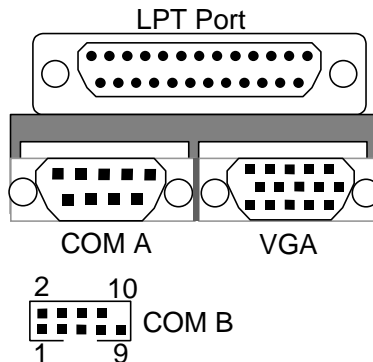
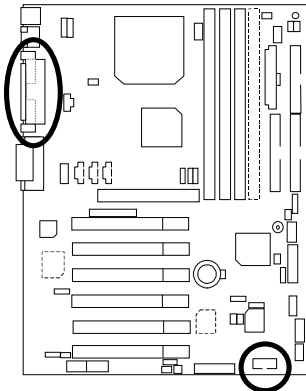



## USB Connector

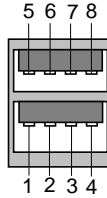
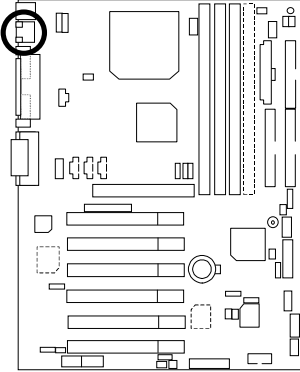

Pin No.	Definition
1	USB V0
2	USB D0-
3	USB D0+
4	GND
5	USB V1
6	USB D1-
7	USB D1+
8	GND

## PS/2 Keyboard &amp; PS/2 Mouse Connector

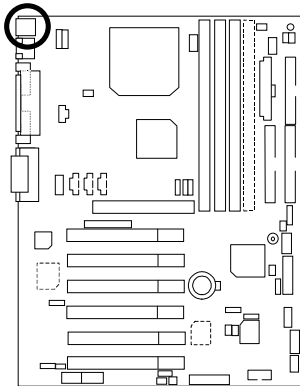

PS/2 Mouse

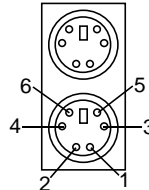

PS/2 Keyboard

PS/2 Mouse/ Keyboard	
Pin No.	Definition
1	Data
2	NC
3	GND
4	VCC (+5V)
5	Clock
6	NC

### J1: CPU Fan

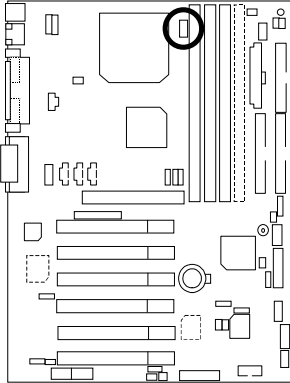

Pin No.	Definition
1	GND
2	+12V
3	SENSE

### J2: Power Fan

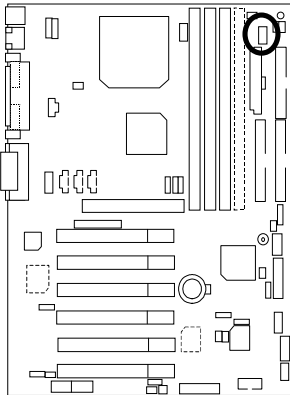

Pin No.	Definition
1	GND
2	+12V
3	SENSE

## J14: System Fan

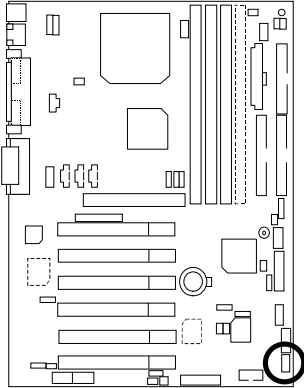

Pin No.	Definition
1	GND
2	+12V
3	SENSE

## ATX Power

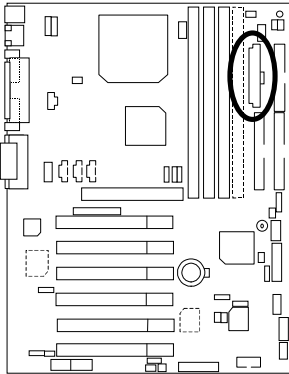

Pin No.	Definition
3,5,7,13,15-17	GND
1,2,11	3.3V
4,6,19,20	VCC
10	+12V
12	-12V
18	-5V
8	Power Good
9	5V SB stand by+5V
14	PS-ON(Soft On/Off)

### JP13: IR/CIR

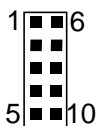
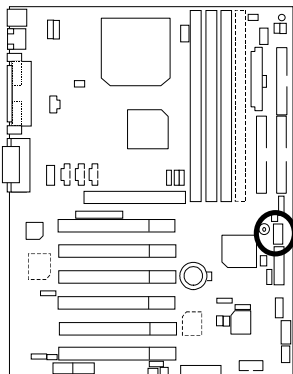

Pin No.	Definition
1	VCC
2	NC
3	IRRX
4	GND
5	IRTX
6	NC
7	CIRRX
8	VCC
9	NC
10	NC

### Floppy Port

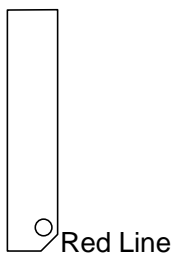
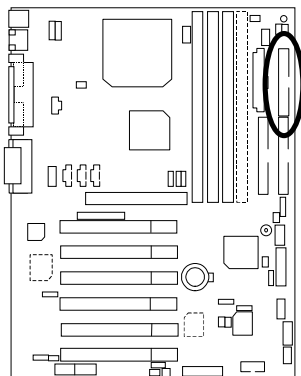

## IDE1 (Primary), IDE2 (Secondary) Port

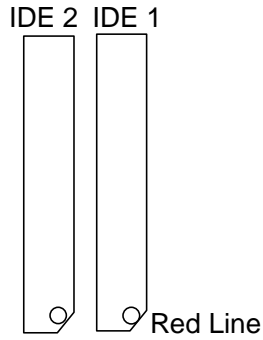
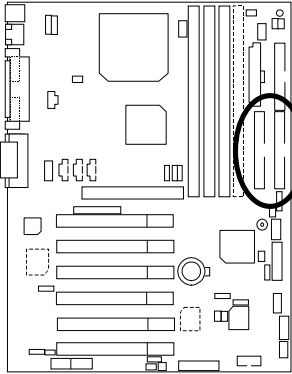

## J13: Ring Power On (Internal Modem Card Wake Up)

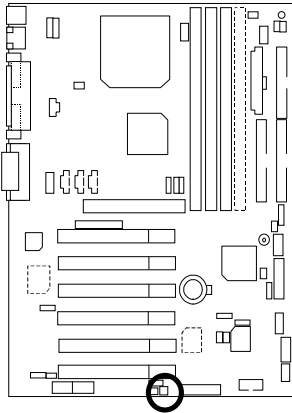

Pin No.	Definition
1	Signal
2	GND

### J12: Wake On LAN

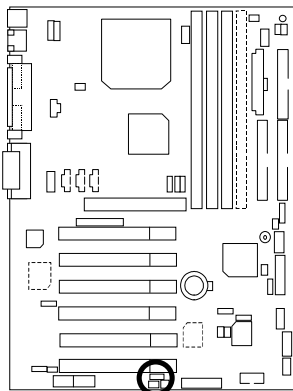

Pin No.	Definition
1	+5V SB
2	GND
3	Signal

### J7: TEL: The connector is for Modem with internal voice connector

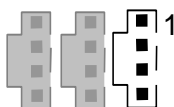
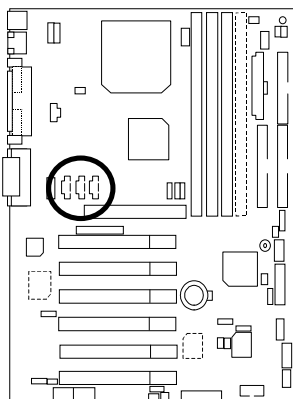

Pin No.	Definition
1	Signal-In
2	GND
3	GND
4	Signal-Out

## J6: AUX\_IN

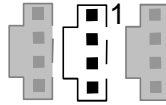
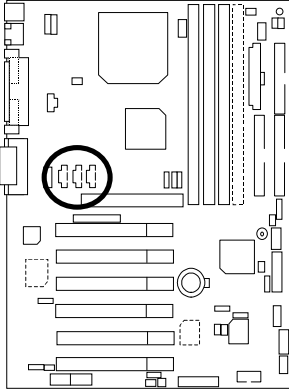

Pin No.	Definition
1	AUX-L
2	GND
3	GND
4	AUX-R

## J5: CD Audio Line In

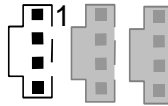
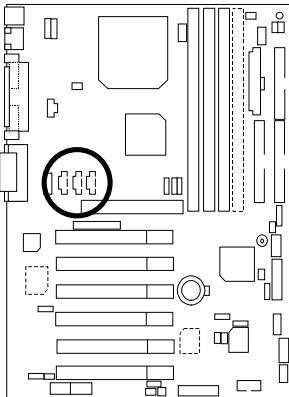

Pin No.	Definition
1	CD-L
2	GND
3	GND
4	CD-R

JP9: SPDIF (The SPDIF output is capable of providing digital audio to external speakers or compressed AC3 data to an external Dolby digital decoder.) [Optional]

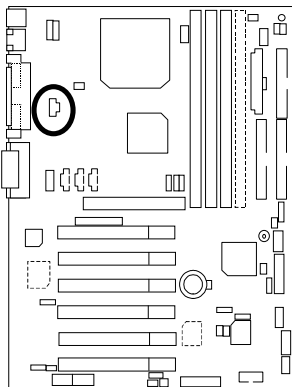

Pin No.	Definition
1	VCC
2	SPDIF OUT
3	GND

JP7: STR LED Connector & LED1: DIMM LED (Optional)

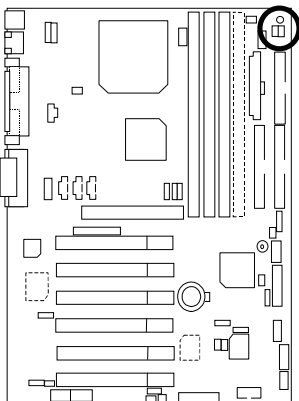

DIMM LED



STR LED Connector External



### CN9: Front USB Port (Optional)

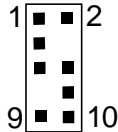
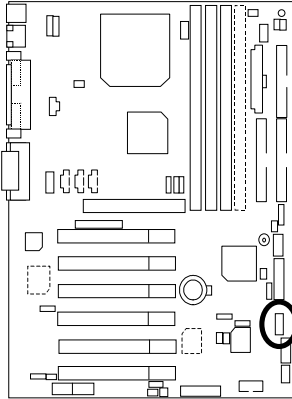

Pin No.	Definition
1	+5V
2	GND
3	USB D2-
4	NC
5	USB D2+
6	USB D3+
7	NC
8	USB D3-
9	GND
10	+5V

### J10: Extra SMBUS

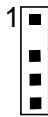
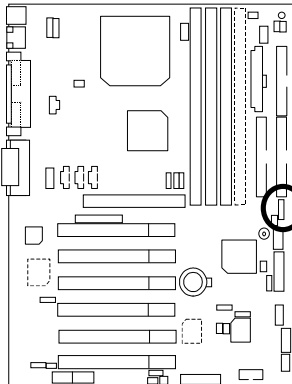

Pin No.	Definition
1	SMB CLK
2	NC
3	GND
4	SMB DATA
5	+5V

CN7: Front Audio (Optional)

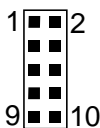
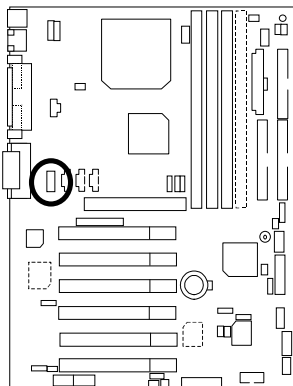

Pin No.	Definition
1	Line-out (R)
2	Line-out (L)
3, 4	GND
5	Line-in/2nd Line-out (R)
6	Line-in (L)/2nd Line-out (L)
7, 8, 10	GND
9	Mic-in

CN8: DFP/TV Out Connector

\*Use only for Gigabyte Digital Flat Panel/TV-Out Daughter card (GA-DFP-x).

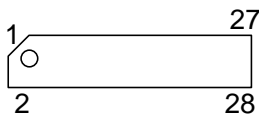
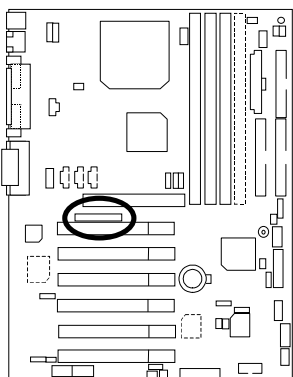

### J15: IA Port (Optional)

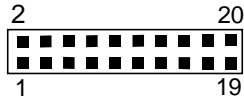
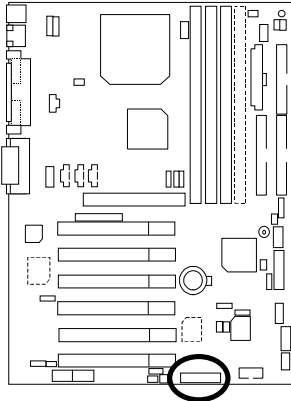

Pin No.	Definition
1	Giga-byte web-site
2	Internet
3	Finance
4	Entertainment
5	Shopping
6	Searching
7	People
8	E-mail
9	Play-pause
10	Forward
11	Rewind
12	Eject
13	Stop
14	Mute
15	Mic Volume up
16	Mic Volume down
17	Speaker Volume up
18	Speaker Volume down
19	Ground
20	NC

### CN12: SCR: Smart Card Reader

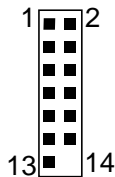
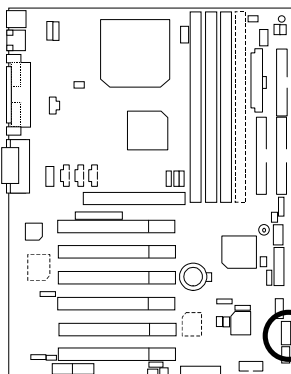

Pin No.	Definition
1	VCC
2,3,4,8,13	NC
5,6,10,12	DATA
7	Clock
9,14	NC
11	GND

## Panel And Jumper Definition

J11: For 2x11 Pins Jumper

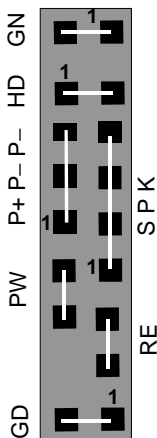
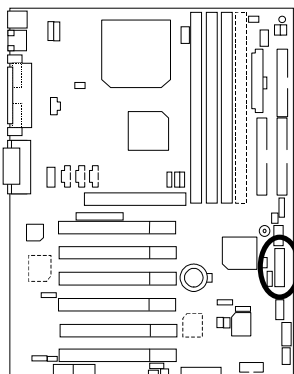

GN (Green Switch)	Open: Normal Operation Close: Entering Green Mode
GD (Green LED)	Pin 1: LED anode(+) Pin 2: LED cathode(-)
HD (IDE Hard Disk Active LED)	Pin 1: LED anode(+) Pin 2: LED cathode(-)
SPK (Speaker Connector)	Pin 1: VCC(+) Pin 2- Pin 3: NC Pin 4: Data(-)
RE (Reset Switch)	Open: Normal Operation Close: Reset Hardware System
P+P-P-(Power LED)	Pin 1: LED anode(+) Pin 2: LED cathode(-) Pin 3: LED cathode(-)
PW (Soft Power Connector)	Open: Normal Operation Close: Power On/Off

### JP18: Clear CMOS Function

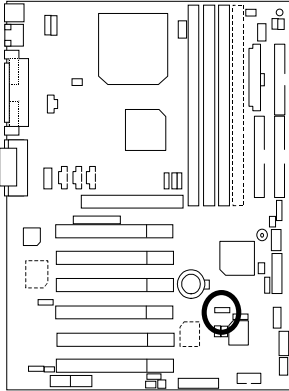

Pin No.	Definition
1-2 close	Clear CMOS
2-3 close	Normal (Default)

### JP4: STR Enable (Optional)

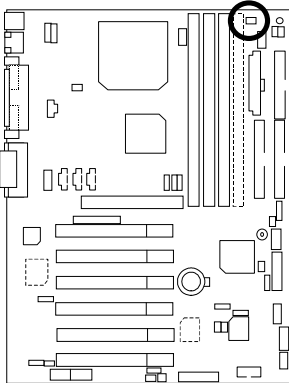

Pin No.	Definition
Open	STR Disabled (Default)
Close	STR Enabled

### JP16: Onboard Sound Function Selection (Optional)

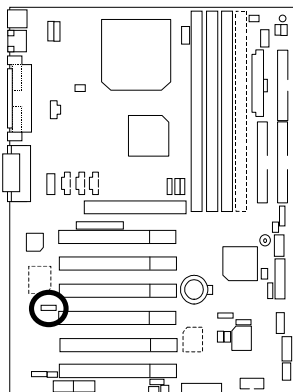

Pin No.	Definition
1-2 close	Enabled Onboard Sound (Default)
2-3 close	Disable Onboard Sound

### JP3: PS/2 Keyboard Power On

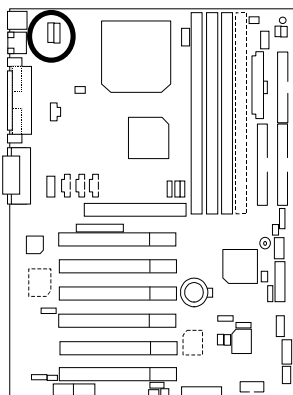

Pin No.	Definition
1-2 close	PS/2 Keyboard Power on Enabled
2-3 close	Normal (Default)

JP1: Rear USB Device Wake up Selection (USB Connector → CN2)

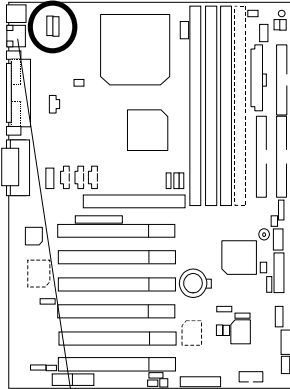

CN2



Pin No.	Definition
1-2 close	Enabled Rear USB Device Wake up
2-3 close	Normal (Default)

(If you want to use “**USB KB/Mouse Wake from S3**” function, you have to set the BIOS setting “**USB KB/Mouse Wake from S3**” enabled, and the jumper “**JP1&JP4**” enabled).  
 \*(Power on the computer and as soon as memory counting starts, press <Del>. You will enter BIOS Setup. Select the item “**POWER MANAGEMENT SETUP**”, then select “**USB KB/Mouse Wake from S3: Enabled**”. Remember to save the setting by pressing “ESC” and choose the “**SAVE & EXIT SETUP**” option.)

JP22: Case Open

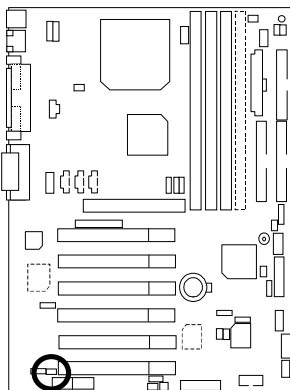

Pin No.	Definition
1	Signal
2	GND

## JP20: FWH Flash Write Protection

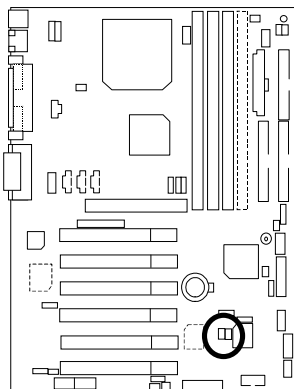

Pin No.	Definition
Open	Normal (Default)
Close	Write Protection

● Please set Jumper JP20 to “Open” to enabled BIOS write function when you update new BIOS or new device.

## JP21: Top Block Lock

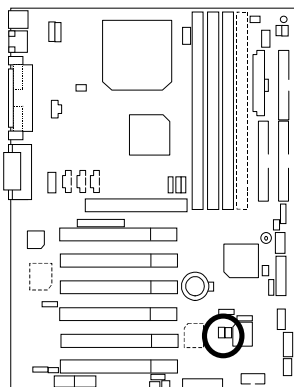

Pin No.	Definition
Open	Top Block Lock
Close	Top Block Unlock (Default)



**JP5: Over Voltage CPU Speed Up (Magic Booster)**  
 (When JP5 set "Close", CPU Voltage is rising 10%)

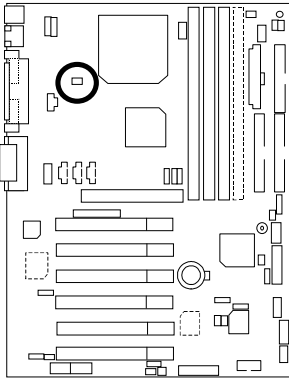

Pin No.	Definition
Close	Turbo [Voltage enhance 10%] for over clock use
Open	Normal (Default)

**JP6: DIMM Over Voltage (Optional)**

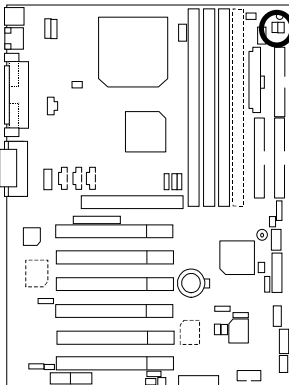

Pin No.	Definition
Close	Enabled DIMM Over Voltage
Open	Disabled DIMM Over Voltage (Default)

### JP12: Internal Buzzer Connector (Optional)

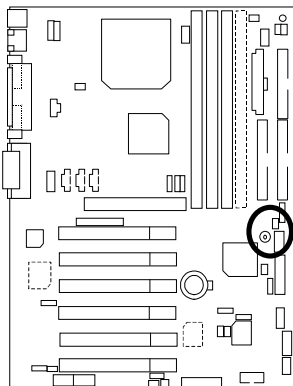

Pin No.	Definition
Open	Internal Buzzer Disabled
Close	Internal Buzzer Enabled (Default)

### JP14: Timeout Reboot Function

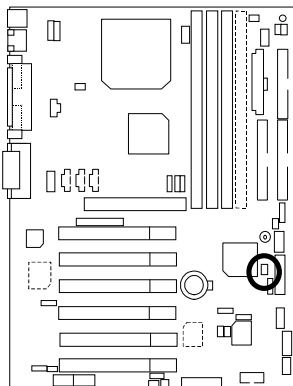

Pin No.	Definition
Open	Timeout Reboot
Close	No Reboot on Timeout

### JP15: Safe mode/Recovery/Normal

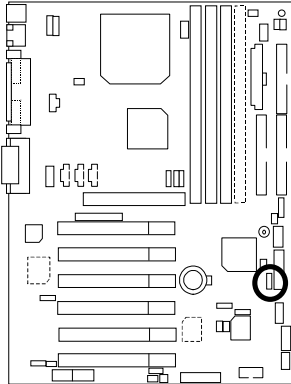

Pin No.	Definition
1-2close	Normal (Default)
2-3close	Safe mode
1-2-3open	Recovery

### JP19: Front USB Device Wake up Selection(USB Port → CN9)[Optional]

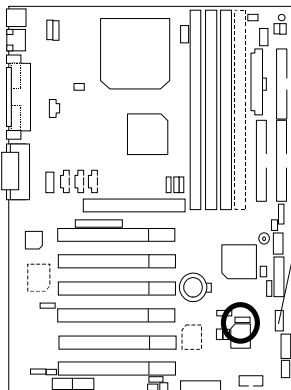

Pin No.	Definition
1-2 close	Enabled Front USB Device Wake up
2-3 close	Normal (Default)

(If you want to use “**USB KB/Mouse Wake from S3**” function, you have to set the BIOS setting “USB KB/Mouse Wake from S3” enabled, and the jumper “**JP19&JP4**” enabled).  
 \*(Power on the computer and as soon as memory counting starts, press <Del>. You will enter BIOS Setup. Select the item “**POWER MANAGEMENT SETUP**”, then select “**USB KB/Mouse Wake from S3: Enabled**”. Remember to save the setting by pressing “ESC” and choose the “**SAVE & EXIT SETUP**” option.)

### JP23: PCI/AGP 3VAUX

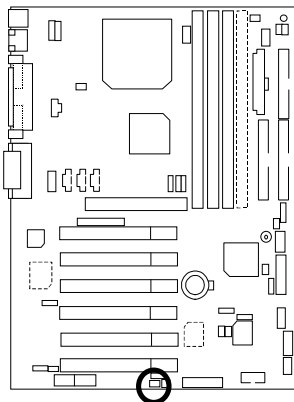

Pin No.	Definition
Open	Disabled PCI/AGP 3VAUX Function
Close	Enabled PCI/AGP 3VAUX (Default)

### JP24: AMR Selection (Optional)

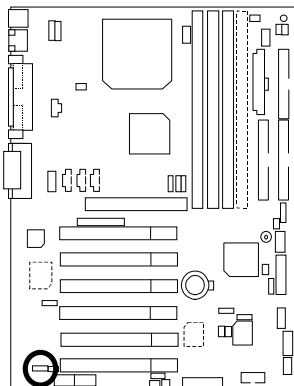

Pin No.	Definition
1-2close	AMR Secondary
2-3close	AMR Primary AC'97 Disabled (Default) (Disabled Onboard CODEC)

## BAT1: Battery

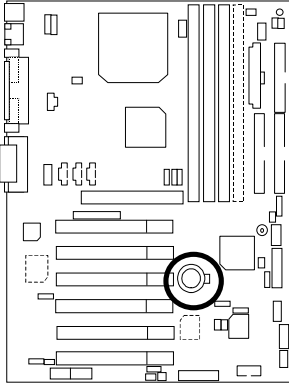

### CAUTION

- ⚠ Danger of explosion if battery is incorrectly replaced.
- ⚠ Replace only with the same or equivalent type recommended by the manufacturer.
- ⚠ Dispose of used batteries according to the manufacturer's instructions.

## Performance List

The following performance data list is the testing results of some popular benchmark testing programs.

These data are just referred by users, and there is no responsibility for different testing data values gotten by users. (The different Hardware & Software configuration will result in different benchmark testing results.)

- CPU Intel Socket 370 Processor
- DRAM (128 x 2) MB SDRAM (Buffalo KM48S8030CT-GA)
- CACHE SIZE 128 KB included in CPU (Celeron);  
256 KB included in CPU (Pentium® !!!)
- DISPLAY On board AGP
- STORAGE Onboard IDE (Quantum KA13600AT) (13.6GB)
- O.S. Windows NT™ 4.0 (SP6a)
- DRIVER Display Driver at 1024 x 768 x 16M x 75Hz

Processor	Intel Pentium® !!! Socket 370		Intel Celeron™ Socket 370	
	866MHz (133x6.5)	850MHz (100x8.5)	600MHz (66x9)	350MHz (100x3.5)
<b>Winbench99</b>				
CPU mark99	75.8	69.1	41.5	29
FPU Winmark 99	4610	4520	3190	1880
Business Disk Winmark 99	5480	5140	4840	4490
Hi-End Disk Winmark 99	12900	12500	12100	12300
Business Graphics Winmark 99	133	113	98.4	91.7
Hi-End Graphics Winmark 99	607	552	381	266
<b>Winstone99</b>				
Business Winstone99	40.2	37.2	29.3	25.3
Hi-End Winstone99	48.8	45	32.8	25.6

☛ If you wish to maximize the performance of your system, please refer to the detail on P.67

# Block Diagram

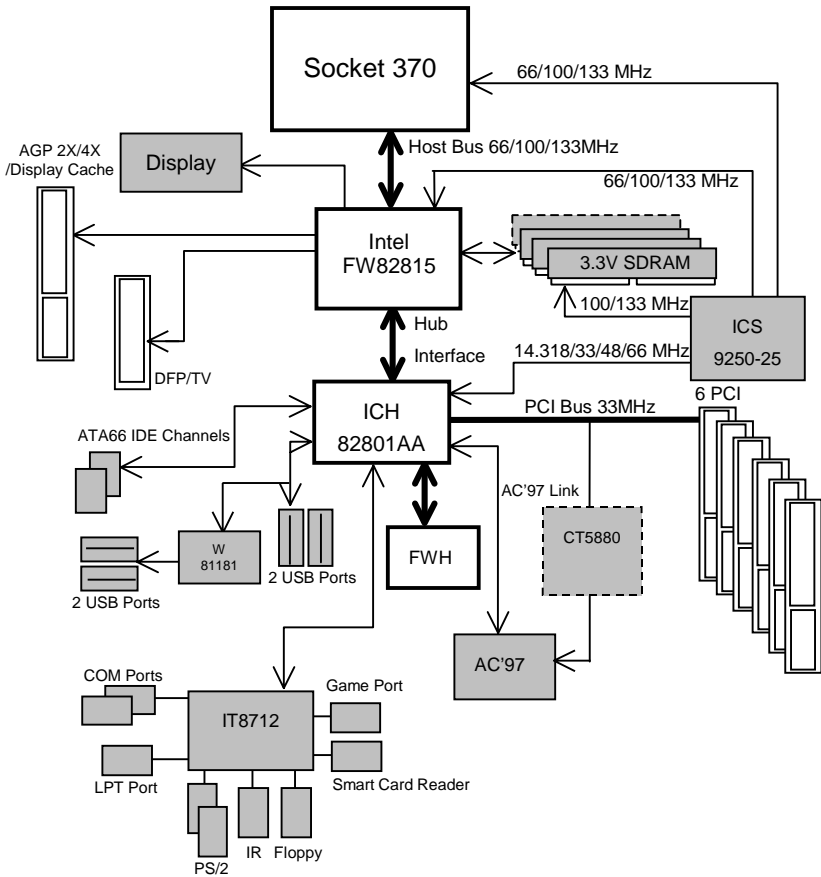

## Suspend To RAM Installation (Optional)

### A.1 Introduce STR function:

Suspend-to-RAM (STR) is a Windows 98 ACPI sleep mode function. When recovering from STR (S3) sleep mode, the system is able, in just a few seconds, to retrieve the last "state" of the system before it went to sleep and recover to that state. The "state" is stored in memory (RAM) before the system goes to sleep. During STR sleep mode, your system uses only enough energy to maintain critical information and system functions, primarily the system state and the ability to recognize various "wake up" triggers or signals, respectively.

### A.2 STR function Installation

Please use the following steps to complete the STR function installation.

#### Step-By-Step Setup

##### Step 1:

To utilize the STR function, the system must be in Windows 98 ACPI mode.

Putting Windows 98 into ACPI mode is fairly easy.

#### Setup with Windows 98 CD:

- A. Insert the Windows 98 CD into your CD-ROM drive, select Start, and then Run.
- B. Type (without quotes) "**D:\setup** " in the window provided. Hit the enter key or click OK.
- C. After setup completes, remove the CD, and reboot your system  
(This manual assumes that your CD-ROM device drive letter is D:).



**Step 2:**

(If you want to use STR Function, please set jumper JP4 Closed.)

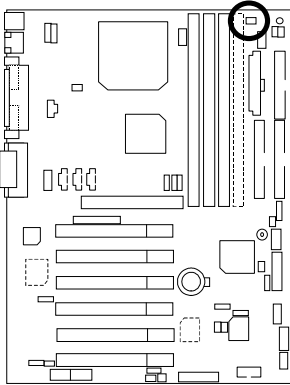

Pin No.	Definition
Open	STR Disabled (Default)
Close	STR Enabled

**Step 3:**

Power on the computer and as soon as memory counting starts, press <Del>. You will enter BIOS Setup. Select the item **"POWER MANAGEMENT SETUP"**, then select **"ACPI Suspend Type: S3 (Suspend to RAM)"**. Remember to save the settings by pressing "ESC" and choose the **"SAVE & EXIT SETUP"** option.

Congratulation! You have completed the installation and now can use the STR function.

### A.3 How to put your system into STR mode?

There are two ways to accomplish this:

1. Choose the "Stand by" item in the "Shut Down Windows" area.
  - A. Press the "Start" button and then select "Shut Down"



- B. Choose the "Stand by" item and press "OK"

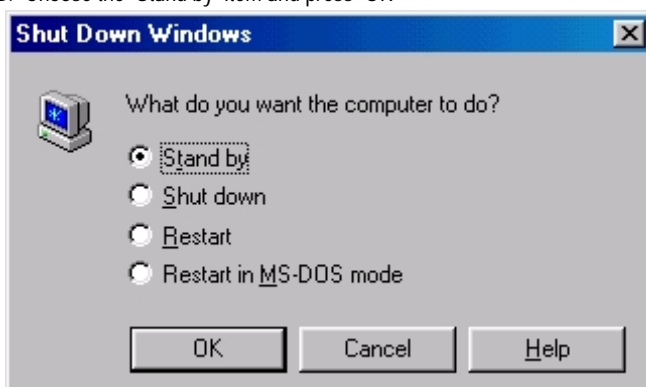

2. Define the system "power on" button to initiate STR sleep mode:

A. Double click "My Computer" and then "Control Panel"

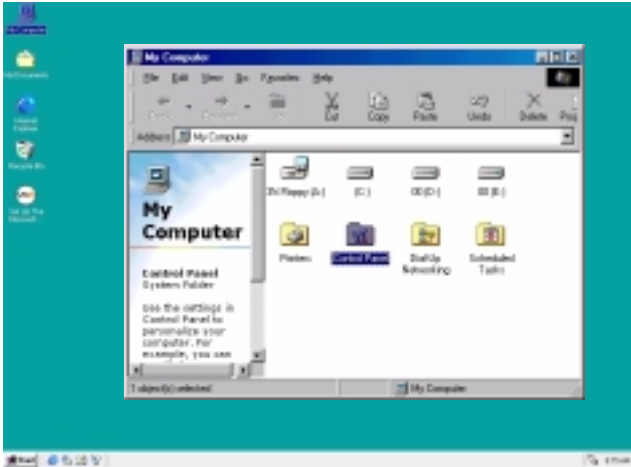

B. Double click the "Power Management" item.

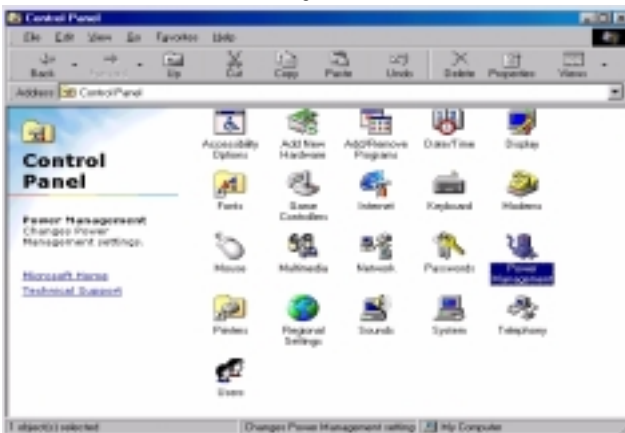

C. Select the "Advanced" tab and "Standby" mode in Power Buttons.

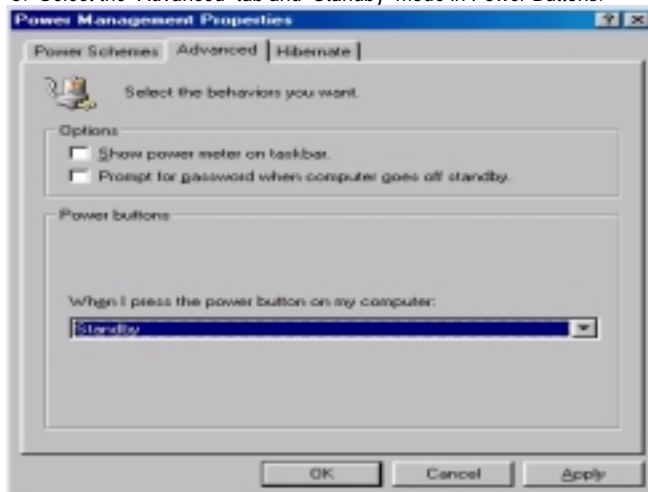

D. Restart your computer to complete setup.

Now when you want to enter STR sleep mode, just momentarily press the "Power on" button.

#### A.4 How to recover from the STR sleep mode?

There are seven ways to "wake up" the system:

1. Press the "Power On" button.
2. Use the "PS/2 Keyboard Power On" function.
3. Use the "Mouse Power On" function.
4. Use the "Resume by Alarm" function.
5. Use the "Modem Ring On" function.
6. Use the "Wake On LAN" function.
7. Use the "USB Device Wake up" function.

**A.5 Notices:**

1. In order for STR to function properly, several hardware and software requirements must be satisfied:
  - A. Your ATX power supply must comply with the ATX 2.01 specification (provide more than 720 mA 5V Stand-By current).
  - B. Your SDRAM must be PC-100 compliant.
2. Jumper JP7 is provided to connect to the STR LED in your system chassis. [Your chassis may not provide this feature.] The STR LED will be illuminated when your system is in STR sleep mode.

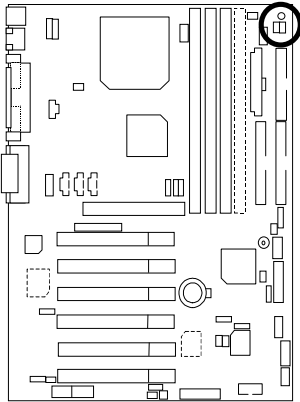

DIMM LED



STR LED Connector External

## Introduce Dual BIOS (Optional)

### A. What is Dual BIOS Technology?

Dual BIOS means that there are two system BIOS (ROM) on the motherboard, one is the Main BIOS and the other is Backup BIOS. Under the normal circumstances, the system works on the Main BIOS. If the Main BIOS is corrupted or damaged, the Backup BIOS can take over while the system is powered on. This means that your PC will still be able to run stably as if nothing has happened in your BIOS.

### B. How to use Dual BIOS?

#### a. Boot Screen

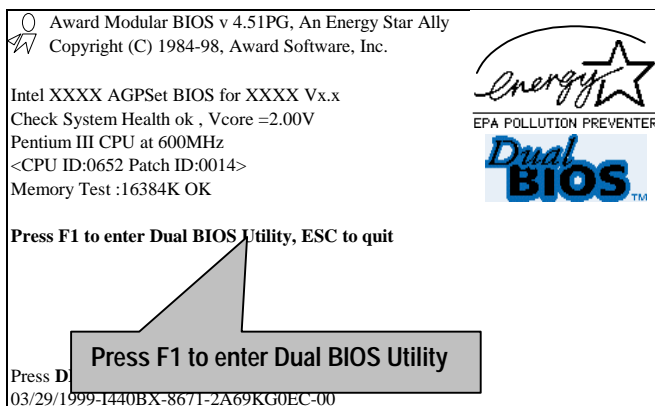

b. Dual BIOS Utility

Dual BIOS Utility V6.60.g.01K (C) 1999, Gigabyte Technology Co., LTD.	
Wide Range Protection	:Disabled
Halt On BIOS Defects	:Disabled
Auto Recovery	:Enabled
Boot From	:Main BIOS
BIOS Recovery	:Main to Backup
F3: Load Default	F5:Start BIOS Recovery
F7: Save And Restart	F9:Exit Without Saving
Use <Space> key to toggle setup	

c. Dual BIOS Item explanation:

**Wide Range Protection: Disabled(Default), Enabled**

*Status 1:*

If any failure (ex. Update ESCD failure, checksum error or reset...) occurs in the Main BIOS , just before the Operating System is loaded and after the power is on, and that the Wide Range Protection is set to "Enable", the PC will boot from Backup BIOS automatically.

*Status 2:*

If the ROM BIOS on peripherals cards(ex. SCSI Cards, LAN Cards,..) emits signals to request restart of the system after the user make any alteration on it, the boot up BIOS will not be changed to the Backup BIOS.

**Halt On BIOS Defects : Disabled(Default), Enabled**

If the BIOS occurs a checksum error or the Main BIOS occurs a WIDE RANGE PROTECTION error and Halt On BIOS Defects set to Enable, the PC will show messages on the boot screen, and the system will pause and wait for the user's instruction.

If Auto Recovery :**Disabled**, it will show *<or the other key to continue.>*

If Auto Recovery :**Enabled**, it will show *<or the other key to Auto Recover.>*

**Auto Recovery : Enabled(Default), Disabled**

When one of the Main BIOS or Backup BIOS occurs checksum failure, the working BIOS will automatically recover the BIOS of checksum failure.

(In the Power Management Setup of the BIOS Setting, if ACPI Suspend Type is set to Suspend to RAM, the Auto Recovery will be set to Enable automatically.)

(If you want to enter the BIOS setting, please press "Del" key when the boot screen appears.)

**Boot From : Main BIOS(Default), Backup BIOS**

*Status 1:*

The user can set to boot from main BIOS or Backup BIOS.

*Status 2:*

If one of the main BIOS or the Backup BIOS fails, this item "*Boot From : Main BIOS(Default)*" will become gray and will not be changed by user.

**BIOS Recovery : Main to Backup**

Auto recovery message:

***BIOS Recovery: Main to Backup***

The means that the Main BIOS works normally and could automatically recover the Backup BIOS.

***BIOS Recovery: Backup to Main***

The means that the Backup BIOS works normally and could automatically recover the Main BIOS.

(This auto recovery utility is set by system automatically and can't be changed by user.)





## DualBIOS™ Technology FAQ

GIGABYTE Technology is pleased to introduce DualBIOS technology, a hot spare for your system BIOS. This newest "Value-added" feature, in a long series of innovations from GIGABYTE, is available on GA-60XM7 Series motherboard. Future GIGABYTE motherboards will also incorporate this innovation.

### **What's DualBIOS™?**

On GIGABYTE motherboards with DualBIOS there are physically two BIOS chips. For simplicity we'll call one your "Main BIOS" and the other we'll call your "Backup" BIOS (your "hot spare"). If your Main BIOS fails, the Backup BIOS almost automatically takes over on your next system boot. Almost automatically and with virtually zero down time! Whether the problem is a failure in flashing your BIOS or a virus or a catastrophic failure of the Main BIOS chip, the result is the same - the Backup BIOS backs you up, almost automatically.

**I. Q: What is DualBIOS™ technology?**

**Answer:**

DualBIOS technology is a patented technology from Giga-Byte Technology. The concept of this technology is based on the redundancy and fault tolerance theory. DualBIOS™ technology simply means there are two system BIOSes (ROM) integrated onto the motherboard. One is a main BIOS, and the other is a backup BIOS. The mainboard will operate normally with the main BIOS, however, if the main BIOS is corrupt or damaged for various reasons, the backup BIOS will be automatically used when the system powered-On. Your PC will operate as before the main BIOS was damaged, and is completely transparent to the user.

**II. Q: Why does anyone need a motherboard with DualBIOS™ technology?**

**Answer:**

In today's systems there are more and more BIOS failures. The most common reasons are virus attacks, BIOS upgrade failures, and/or deterioration of the BIOS (ROM) chip itself.

1. New computer viruses are being found that attack and destroy the system BIOS. They may corrupt your BIOS code, causing your PC to be unstable or even not boot normally.
2. BIOS data will be corrupted if a power loss/surge occurs, or if a user resets the system, or if the power button is pressed during the process of performing a system BIOS upgrade.
3. If a user mistakenly updates their mainboard with the incorrect BIOS file, then the system may not be able to boot correctly. This may cause the PC system hang in operation or during boot.
4. A flash ROM's life cycle is limited according to electronic characteristics. The modern PC utilizes the Plug and Play BIOS, and is updated regularly. If a user changes peripherals often, there is a slight chance of damage to the flash ROM.

With Giga-Byte Technology's patented DualBIOS™ technology you can reduce the possibility of hangs during system boot up, and/or loss BIOS data due to above reasons. This new technology will eliminate valuable system down time and costly repair bills cause by BIOS failures.

### **III. Q: How does DualBIOS™ technology work?**

#### **Answer:**

1. DualBIOS™ technology provides a wide range of protection during the boot up procedure. It protects your BIOS during system POST, ESCD update, and even all the way to PNP detection/assignment.
2. DualBIOS™ provides automatic recovery for the BIOS. When the first BIOS used during boot up does not complete or if a BIOS checksum error occurs, boot-up is still possible. In the DualBIOS™ utility, the "Auto Recovery" option will guarantee that if either the main BIOS or backup BIOS is corrupted, the DualBIOS™ technology will use the good BIOS and correct the wrong BIOS automatically.
3. DualBIOS™ provides manual recovery for the BIOS. DualBIOS™ technology contains a built-in flash utility, which can flash your system BIOS from backup to main and/or visa versa. There is no need for an OS-dependent flash utility program.
4. DualBIOS™ contains a one-way flash utility. The built-in one-way flash utility will ensure that the corrupt BIOS is not mistaken as the good BIOS during recovery and that the correct BIOS (main vs. backup) will be flashed. This will prevent the good BIOS from being flashed.

### **IV. Q: Who Needs DualBIOS™ technology?**

#### **Answer:**

1. Every user should have DualBIOS™ technology due to the advancement of computer viruses. Everyday, there are new BIOS-type viruses discovered that will destroy your system BIOS. Most commercial products on the market do not have solutions to guard against this type of virus intrusion. The DualBIOS™ technology will provide a state-of-the-art solution to protect your PC:  
Case I.) Vicious computer viruses may wipe out your entire system BIOS. With a conventional single system BIOS PC, the PC will not be functional until it is sent for repairs.  
Case II.) If the "Auto Recovery" option is enabled in the DualBIOS™ utility, and if a virus corrupts your system BIOS, the backup BIOS will automatically reboot the system and correct the main BIOS.  
Case III.) A user may override booting from the main system BIOS. The DualBIOS™ utility may be entered to manually change the boot sequence to boot from the backup BIOS.

2. During or after a BIOS upgrade, if DualBIOS™ detects that the main BIOS is corrupt, the backup BIOS will take over the boot-up process automatically. Moreover, it will verify the main and backup BIOS checksums when booting-up. DualBIOS™ technology examines the checksum of the main and backup BIOS while the system is powered on to guarantee your BIOS operates properly.
3. Power Users will have the advantage of having two BIOS versions on their mainboard. The benefit is being able to select either version BIOS to suit the performance system needs.
4. Flexibility for high-end desktop PCs and workstation/servers. In the DualBIOS™ utility, the option can be set, "Halt On When BIOS Defects," to be enabled to halt your system with a warning message that the main BIOS has been corrupted. Most workstation/servers require constant operation to guarantee services have not been interrupted. In this situation, the "Halt On When BIOS Defects" message may be disabled to avoid system pauses during normal booting. Another advantage you gain from Giga-Byte's DualBIOS™ technology is the ability to upgrade from dual 2 Mbit BIOS to dual 4 Mbit BIOS in the future if extra BIOS storage is need.

## Four Speaker & SPDIF Introduction (Optional)

### Four Speaker Introduction

#### A. What is Four Speaker?

The Creative CT5880 audio chip can support 4 speaker output, if you select "Four speaker" out, Line in will be change to another line out.

#### B. How to use Four Speaker?

- a. Press the audio icon and then select "Configuration 3D Audio".

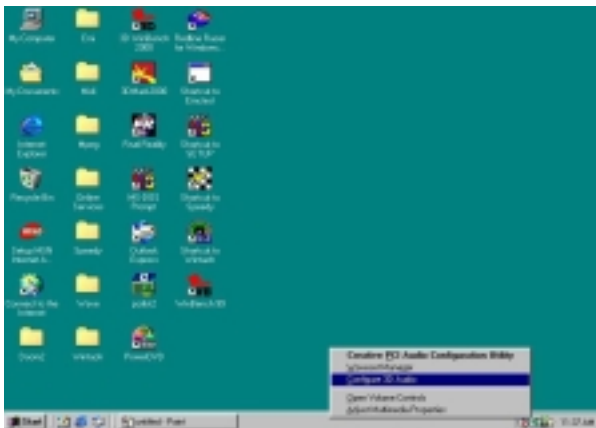

- b. Two speaker (Default).

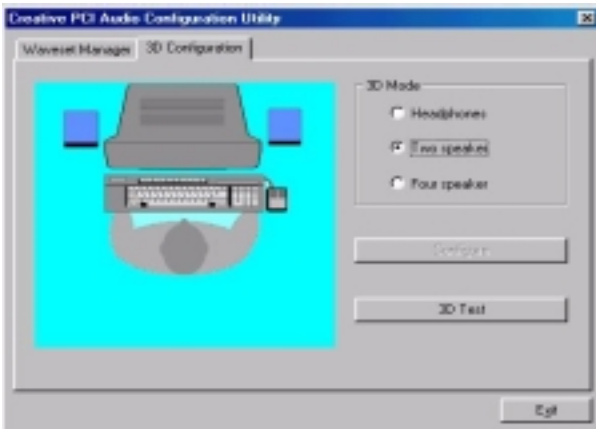

c. Click "Four speaker" item.



### C. Four Speaker Application

The four speaker function will only support in application software that use Microsoft DirectX and Creative EAX. For example, the game titles, software DVD player and MP3 player. Those software support Microsoft DirectX, so they can support four speaker output.

## SPDIF Introduction

### A. What is SPDIF?

The SPDIF output is capable of providing digital audio to external speakers or compressed AC3 data to an external Dolby digital decoder.

### B. How to use SPDIF?

a. Press your mouse right button in "My Computer" and then select the "Properties" item.

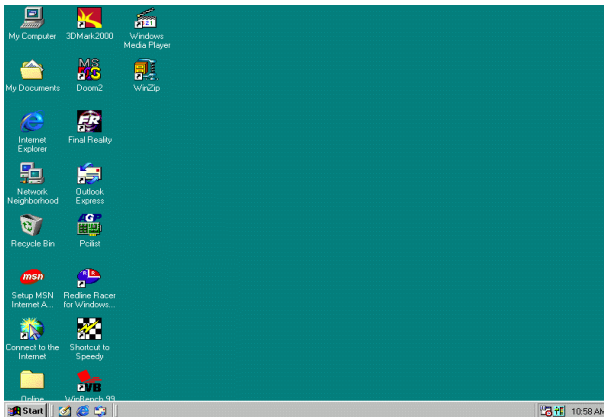

b. Click "Device Manager" item.

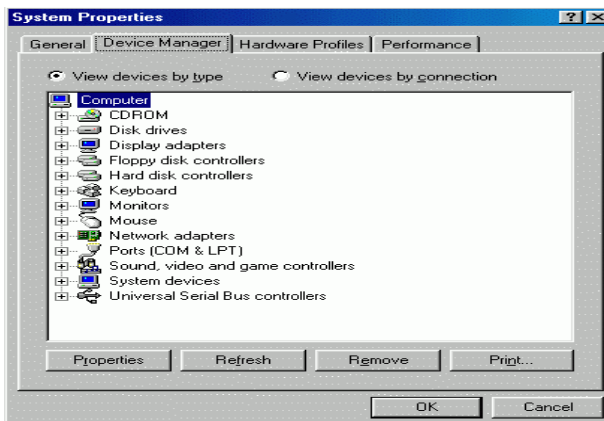

## 60XM7 Series Motherboard

---

- c. Press "Sound, video and game controllers" item and then select the "Creative Sound Blaster PCI128" item.

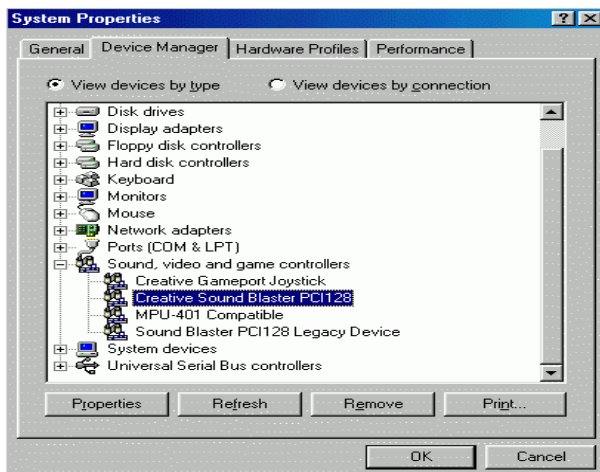

- d. Press "Settings" item and then select the "Output Mode" item.

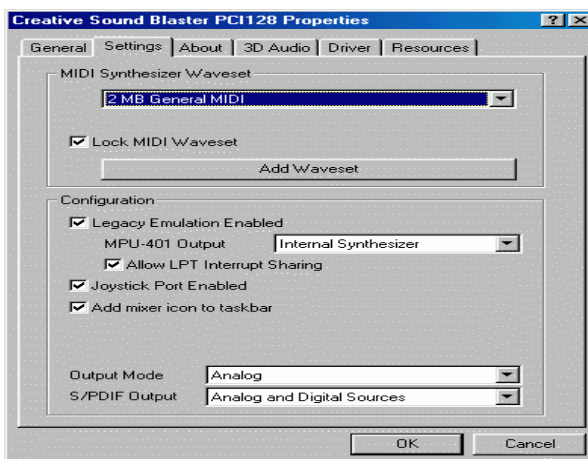



e. Click "Digital" item, Line Out will be change to SPDIF Out.

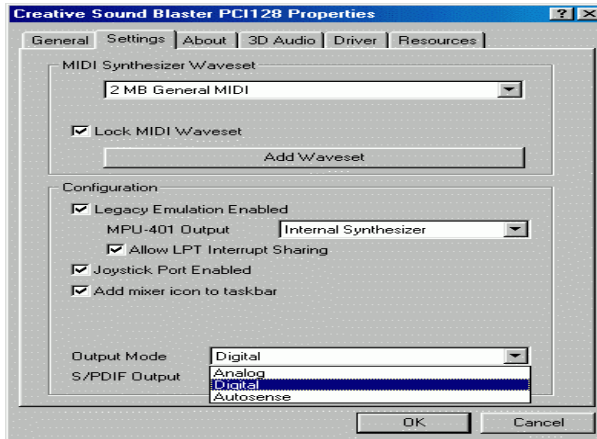

f. Recommend you to select "Autosense", it will auto detect the audio jack you plug in to Line Out is mono or stereo, and then change to SPDIF Out or Speaker out automatically.

## @BIOS™ Introduction

### Gigabyte announces @BIOS™ Windows BIOS live update utility



Have you ever updated BIOS by yourself? Or like many other people, you just know what BIOS is, but always hesitate to update it? Because you think updating newest BIOS is unnecessary and actually you don't know how to update it.

Maybe not like others, you are very experienced in BIOS updating and spend quite a lot of time to do it. But of course you don't like to do it too much. First, download different BIOS from website and then switch the operating system to DOS mode. Secondly, use different flash utility to update BIOS. The above process is not a interesting job. Besides, always be carefully to store the BIOS source code correctly in your disks as if you update the wrong BIOS, it will be a nightmare.

Certainly, you wonder why motherboard vendors could not just do something right to save your time and effort and save you from the lousy BIOS updating work? Here it comes! Now Gigabyte announces @BIOS™ --the first Windows BIOS live update utility. This is a smart BIOS update software. It could help you to download the BIOS from internet and update it. Not like the other BIOS update software, it's a Windows utility. With the help of "@BIOS™", BIOS updating is no more than a click.

Besides, no matter which mainboard you are using, if it's a Gigabyte's product\*, @BIOS™ help you to maintain the BIOS. This utility could detect your correct mainboard model and help you to choose the BIOS accordingly. It then downloads the BIOS from the nearest Gigabyte ftp site automatically. There are several different choices; you could use "Internet Update" to download and update your BIOS directly. Or you may want to keep a backup for your current BIOS, just choose "Save Current BIOS" to save it first. You make a wise choice to use Gigabyte, and @BIOS™ update your BIOS smartly. You are now worry free from updating wrong BIOS, and capable to maintain and manage your BIOS easily. Again, Gigabyte's innovative product erects a milestone in mainboard industries.

For such a wonderful software, how much it costs? Impossible! It's free! Now, if you buy a Gigabyte's motherboard, you could find this amazing software in the attached driver CD. But please remember, connected to internet at first, then you could have a internet BIOS update from your Gigabyte @BIOS™.

## EasyTuneIII™ Introduction

### Gigabyte announces **EasyTuneIII™** Windows overdrive utility



“Overdrive” might be one of the most common issues in computer field. But have many users ever tried it? The answer is probably “no”. Because “overdrive” is thought to be very difficult and includes a lot of technical know-how, sometimes “overdrive” is even considered as special skills found only in some enthusiasts.

But as to the experts in “overdrive”, what’s the truth? They may spend quite a lot of time and money to study, try and use many different hardware and software tools to do “overdrive”. And even with these technologies, they still learn that it’s quite a risk because the safety and stability of an “overdrive” system is unknown.

Now everything is different because of a Windows overdrive utility EasyTuneIII™ --announced by Gigabyte. This utility has totally changed the gaming rule of “overdrive”. This is the first overdrive utility suitable for both normal and power users. Users can choose either “Easy Mode” or “Advanced Mode” to run “overdrive” at their convenience. For users who choose “Easy Mode”, they just need to click “Auto Optimize” to have auto and immediate CPU overclocking. This software will then overdrive CPU speed automatically with the result being shown in the control panel. If someone prefers to “overdrive” by oneself, there is also another choice. Click “Advanced Mode” to enjoy “sport drive” class overclocking. In “Advanced Mode”, one can change the system bus speed in small increments to get ultimate system performance. And no matter which mainboard is used, if it’s a Gigabyte’s product\*, EasyTuneIII™ helps to perform the best of system.

Besides, different from other traditional over-clocking methods, EasyTuneIII™ doesn’t require users to change neither BIOS nor hardware switch/ jumper setting; on the other hand, they can do “overdrive” at only one click. Therefore, this is a safer way for “overdrive” as nothing is changed on software or hardware. If user runs EasyTuneIII™ over system’s limitation, the biggest lost is only to restart the computer again and the side effect is then well controlled. Moreover, if one well-performed system speed been tested in EasyTuneIII™, user can “Save” this bus speed and “Load” it in next time. Obviously, Gigabyte EasyTuneIII™ has already turned the

"overdrive" technology toward to a newer generation.

This wonderful software is now free bundled in Gigabyte motherboard attached driver CD. Users may make a test drive of "EasyTuneIII™" to find out more amazing features by themselves.

For further technical information, please link to: <http://www.gigabyte.com.tw>

**※ Note: If your IUCD version is 1.6 or below, please visit our website and download the latest EasyTuneIII™ version.**



## Memory Installation

The motherboard has 4 dual inline memory module (DIMM) sockets support 6 banks. The BIOS will automatically detects memory type and size. To install the memory module, just push it vertically into the DIMM Slot .The DIMM module can only fit in one direction due to the two notch. Memory size can vary between sockets.

Install memory in any combination table:

Location	168-pin SDRAM DIMM Modules	Note
DIMM1 (Bank 0,1)	Single – Sided	
	Double – Sided	
DIMM2 (Bank 2,3)	Single – Sided	
	Double – Sided	
DIMM3 (Bank 4,5)	Single – Sided	DIMM4 have only single-sided
	Double – Sided	DIMM4 must be empty
DIMM4 (Bank 4,5)	Single – Sided	DIMM3 must install single-sided
	Double – Sided	DIMM3 must be empty
Total System Memory (Max 512MB)		

★ Supports 16 / 32 / 64 / 128 / 256/ 512 MB SDRAM DIMM Modules.

● Note:

1. DIMM 4 is optional.
2. When you're using single-sided memory on DIMM4, you must use single-sided memory on DIMM3. If you use double-sided memory on DIMM4, please do not insert any memory on DIMM3.

## 60XM7 Series Motherboard

---

 Page Index for BIOS Setup	Page
The Main Menu	P.57
Standard CMOS Features	P.60
Advanced BIOS Features	P.64
Advanced Chipset Features	P.67
Integrated Peripherals	P.73
Power Management Setup	P.79
PnP / PCI Configurations	P.83
PC Health Status	P.85
Frequency / Voltage Control	P.87
Load Fail-Safe Defaults	P.88
Load Optimized Defaults	P.89
Set Supervisor / User Password	P.90
Save & Exit Setup	P.91
EXIT Without Saving	P.92



## BIOS Setup

BIOS Setup is an overview of the BIOS Setup Program. The program that allows users to modify the basic system configuration. This type of information is stored in battery-backed CMOS RAM so that it retains the Setup information when the power is turned off.

### ENTERING SETUP

Power ON the computer and press <Del> immediately will allow you to enter Setup. If the message disappears before you respond and you still wish to enter Setup, restart the system to try again by turning it OFF then ON or pressing the "RESET" bottom on the system case. You may also restart by simultaneously press <Ctrl> – <Alt>– <Del> keys.

### CONTROL KEYS

<↑>	Move to previous item
<↓>	Move to next item
<<<>	Move to the item in the left hand
<>>>	Move to the item in the right hand
<Esc>	Main Menu - Quit and not save changes into CMOS Status Page Setup Menu and Option Page Setup Menu - Exit current page and return to Main Menu
<+/PgUp>	Increase the numeric value or make changes
<-/PgDn>	Decrease the numeric value or make changes
<F1>	General help, only for Status Page Setup Menu and Option Page Setup Menu
<F2>	Reserved
<F3>	Reserved
<F4>	Reserved
<F5>	Restore the previous CMOS value from CMOS, only for Option Page Setup Menu
<F6>	Load the default CMOS value from BIOS default table, only for Option Page Setup Menu
<F7>	Load the Optimized Defaults
<F8>	Reserved
<F9>	Reserved
<F10>	Save all the CMOS changes, only for Main Menu

## GETTING HELP

### Main Menu

The on-line description of the highlighted setup function is displayed at the bottom of the screen.

### Status Page Setup Menu / Option Page Setup Menu

Press F1 to pop up a small help window that describes the appropriate keys to use and the possible selections for the highlighted item. To exit the Help Window press <Esc>.

## The Main Menu

Once you enter Award BIOS CMOS Setup Utility, the Main Menu (Figure 2) will appear on the screen. The Main Menu allows you to select from nine setup functions and two exit choices. Use arrow keys to select among the items and press <Enter> to accept or enter the sub-menu.

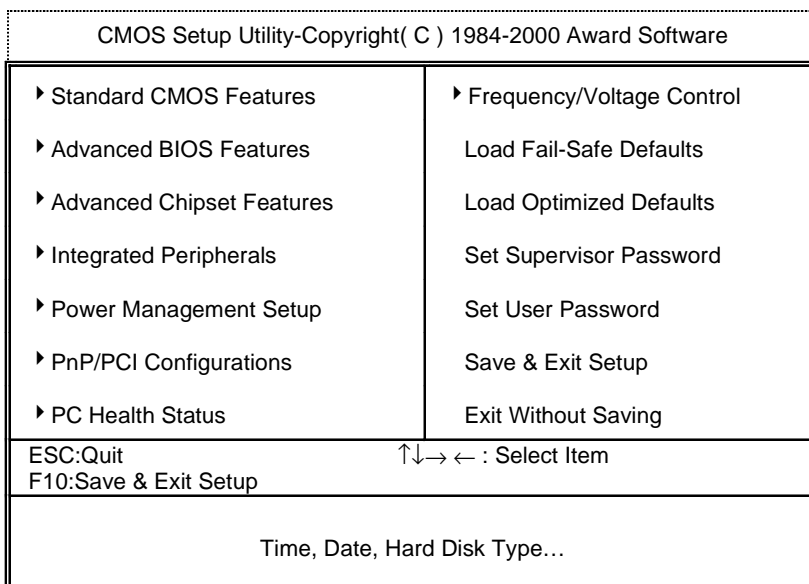

Figure 2: Main Menu

- **Standard CMOS Features**

This setup page includes all the items in standard compatible BIOS.

- **Advanced BIOS Features**

This setup page includes all the items of Award special enhanced features.

- **Advanced Chipset Features**

This setup page includes all the items of chipset special features.

- **Integrated Peripherals**

This setup page includes all onboard peripherals.

- **Power Management Setup**

This setup page includes all the items of Green function features.

- **PnP/PCI Configurations**

This setup page includes all the configurations of PCI & PnP ISA resources.

- **PC Health Status**

This setup page is the System auto detect Temperature, voltage, fan, speed.

- **Frequency/Voltage Control**

This setup page is control CPU's clock and frequency ratio.

- **Load Fail-Safe Defaults**

Fail-Safe Defaults indicates the value of the system parameters which the system would be in safe configuration.

- **Load Optimized Defaults**

Optimized Defaults indicates the value of the system parameters which the system would be in best performance configuration.

- **Set Supervisor password**

Change, set, or disable password. It allows you to limit access to the system and Setup, or just to Setup.

- **Set User password**

Change, set, or disable password. It allows you to limit access to the system.

- **Save & Exit Setup**

Save CMOS value settings to CMOS and exit setup.

- **Exit Without Saving**

Abandon all CMOS value changes and exit setup.

## Standard CMOS Features

The items in Standard CMOS Setup Menu (Figure 3) are divided into 9 categories. Each category includes no, one or more than one setup items. Use the arrows to highlight the item and then use the <PgUp> or <PgDn> keys to select the value you want in each item.

CMOS Setup Utility-Copyright( C ) 1984-2000 Award Software Standard CMOS Features		
Date (mm:dd:yy)	Mon , Feb 21 2000	Item Help
Time (hh:mm:ss)	2 : 31 : 24	
▶ IDE Primary Master	Press Enter None	Menu Level ▶
▶ IDE Primary Slave	Press Enter None	Change the
▶ IDE Secondary Master	Press Enter None	Day, month,
▶ IDE Secondary Slave	Press Enter None	Year and
		century
Drive A	1.44M, 3.5 in.	
Drive B	None	
Floppy 3 Mode Support	Disabled	
Video	EGA / VGA	
Halt On	All, But Keyboard	
Base Memory	640K	
Extended Memory	63488K	
Total Memory	64512K	
↑↓→←:Move Enter:Select +/-/PU/PD:Value F10:Save ESC:Exit F1:General Help F5:Previous Values F6:Fail-Safe Defaults F7:Optimized Defaults		

Figure 3: Standard CMOS Features

- **Date**

The date format is <week>, <month> <day> <year>.

Week	The week, from Sun to Sat, determined by the BIOS and is display-only
Month	The month, Jan. Through Dec.
Day	The day, from 1 to 31 (or the maximum allowed in the month)
Year	The year, from 1994 through 2079

- **Time**

The times format in <hour> <minute> <second>. The time is calculated base on the 24-hour military-time clock. For example, 1 p.m. is 13:00:00.

- **IDE Primary Master, Slave / Secondary Master, Slave**

The category identifies the types of hard disk from drive C to F that has been installed in the computer. There are two types: auto type, and manual type. Manual type is user-definable; Auto type which will automatically detect HDD type.

Note that the specifications of your drive must match with the drive table. The hard disk will not work properly if you enter improper information for this category.

If you select User Type, related information will be asked to enter to the following items. Enter the information directly from the keyboard and press <Enter>. Such information should be provided in the documentation form your hard disk vendor or the system manufacturer.

CYLS.	Number of cylinders
HEADS	number of heads
PRECOMP	write precomp
LANDZONE	Landing zone
SECTORS	number of sectors

If a hard disk has not been installed select NONE and press <Enter>.

- **Drive A / Drive B**

The category identifies the types of floppy disk drive A or drive B that has been installed in the computer.

None	No floppy drive installed
360K, 5.25 in.	5.25 inch PC-type standard drive; 360K byte capacity.
1.2M, 5.25 in.	5.25 inch AT-type high-density drive; 1.2M byte capacity (3.5 inch when 3 Mode is Enabled).
720K, 3.5 in.	3.5 inch double-sided drive; 720K byte capacity
1.44M, 3.5 in.	3.5 inch double-sided drive; 1.44M byte capacity.
2.88M, 3.5 in.	3.5 inch double-sided drive; 2.88M byte capacity.

- **Floppy 3 Mode Support (for Japan Area)**

Disabled	Normal Floppy Drive. <b>(Default value)</b>
Drive A	Drive A is 3 mode Floppy Drive.
Drive B	Drive B is 3 mode Floppy Drive.
Both	Drive A & B are 3 mode Floppy Drives.

- **Video**

The category detects the type of adapter used for the primary system monitor that must match your video display card and monitor. Although secondary monitors are supported, you do not have to select the type in setup.

EGA/VGA	Enhanced Graphics Adapter/Video Graphics Array. For EGA, VGA, SVGA, or PGA monitor adapters
CGA 40	Color Graphics Adapter, power up in 40 column mode
CGA 80	Color Graphics Adapter, power up in 80 column mode
MONO	Monochrome adapter, includes high resolution monochrome adapters

- **Halt on**

The category determines whether the computer will stop if an error is detected during power up.

NO Errors	The system boot will not stop for any error that may be detected and you will be prompted.
All Errors	Whenever the BIOS detects a non-fatal error the system will be stopped.
All, But Keyboard	The system boot will not stop for a keyboard error; it will stop for all other errors. <b>(Default value)</b>
All, But Diskette	The system boot will not stop for a disk error; it will stop for all other errors.
All, But Disk/Key	The system boot will not stop for a keyboard or disk error; it will stop for all other errors.

- **Memory**

The category is display-only which is determined by POST (Power On Self Test) of the BIOS.

**Base Memory**

The POST of the BIOS will determine the amount of base (or conventional) memory installed in the system.

The value of the base memory is typically 512 K for systems with 512 K memory installed on the motherboard, or 640 K for systems with 640 K or more memory installed on the motherboard.

**Extended Memory**

The BIOS determines how much extended memory is present during the POST.

This is the amount of memory located above 1 MB in the CPU's memory address map.



## Advanced BIOS Features

CMOS Setup Utility-Copyright( C ) 1984-2000 Award Software Advanced BIOS Features		
		Item Help
Virus Warning	Disabled	<b>Menu Level ▶</b> Allows you to choose the VIRUS Warning feature For IDE Hard disk Boot sector Protection. If this Function is enable And someone Attempt to write Data into this area , BIOS will show A warning Message on Screen and alarm beep
BIOS Flash Protection	Disabled	
※Processor Number Feature	Enabled	
First Boot Device	Floppy	
Second Boot Device	HDD-0	
Third Boot Device	LS120	
Boot Up Floppy Seek	Enabled	
Boot Up NumLock Status	On	
Security Option	Setup	
HDD S.M.A.R.T. Capability	Disabled	
Report No FDD For WIN 95	No	

↑↓→←:Move Enter:Select +/-PU/PD:Value F10:Save ESC:Exit F1:General Help  
F5:Previous Values F6:Fail-Safe Defaults F7:Optimized Defaults

Figure 4: Advanced BIOS Features

※System will detect automatically and show up when you install the Pentium® !!! processor.

- **Virus Warning**

If it is set to enable, the category will flash on the screen when there is any attempt to write to the boot sector or partition table of the hard disk drive. The system will halt and the following error message will appear in the mean time. You can run anti-virus program to locate the problem.

Enabled	Activate automatically when the system boots up causing a warning message to appear when anything attempts to access the boot sector or hard disk partition table.
Disabled	No warning message to appear when anything attempts to access the boot sector or hard disk partition table. <b>(Default value)</b>

- **BIOS Flash Protection**

Enabled	Enabled BIOS Flash Protection.
Disabled	Disabled BIOS Flash Protection. <b>(Default Value)</b>

- **Processor Number Feature**

This item will show up when you install the Pentium® !!! processor.

Enabled	Pentium® !!! Processor Number Feature. <b>(Default value)</b>
Disabled	Disabled this function.

- **First / Second / Third Boot device**

Floppy	Select your boot device priority by Floppy.
LS120	Select your boot device priority by LS120.
ZIP	Select your boot device priority by ZIP.
HDD-0-3	Select your boot device priority by HDD-0-3.
SCSI	Select your boot device priority by SCSI.
CDROM	Select your boot device priority by CDROM.
Disable	Disable this function.
LAN	Select your boot device priority by LAN.

- **Boot Up Floppy Seek**

During POST, BIOS will determine the floppy disk drive installed is 40 or 80 tracks. 360 K type is 40 tracks 720 K, 1.2 M and 1.44 M are all 80 tracks.

Enabled	BIOS searches for floppy disk drive to determine it is 40 or 80 tracks. Note that BIOS can not tell from 720 K, 1.2 M or 1.44 M drive type as they are all 80 tracks. <b>(Default value)</b>
Disabled	BIOS will not search for the type of floppy disk drive by track number. Note that there will not be any warning message if the drive installed is 360 K.

- **Boot Up NumLock Status**

On	Keypad is number keys. <b>(Default value)</b>
Off	Keypad is arrow keys.

- **Security Option**

This category allows you to limit access to the system and Setup, or just to Setup.

System	The system can not boot and can not access to Setup page will be denied if the correct password is not entered at the prompt.
Setup	The system will boot, but access to Setup will be denied if the correct password is not entered at the prompt. <b>(Default value)</b>

- **HDD S.M.A.R.T. Capability**

Enabled	Enabled HDD S.M.A.R.T. Capability.
Disabled	Disabled HDD S.M.A.R.T. Capability. <b>(Default value)</b>

- **Report No FDD For WIN 95**

No	Assign IRQ6 For FDD. <b>(Default value)</b>
Yes	FDD Detect IRQ6 Automatically.

## Advanced Chipset Features

CMOS Setup Utility-Copyright( C ) 1984-2000 Award Software Advanced Chipset Features		
		Item Help
Top Performance	Disabled	
SDRAM Timing Control	Auto	
※ SDRAM CAS Latency Time	3	Menu Level ▶
※ SDRAM Cycle Time Tras/Trc	7/9	
※ SDRAM RAS-to-CAS Delay	3	
※ SDRAM RAS Precharge Time	3	
Delayed Transaction	Enabled	
On-Chip Video Window Size	64MB	
AGP Graphics Aperture Size	64MB	
♣Display Cache Frequency	133MHz	
◆System Memory Frequency	Auto	
*Onboard Display Cache Setting*		
♣Initial Display Cache	Enabled	
♣Display Cache Timing	Auto	
SDRAM Buffer Strength	Auto	
X SWE#, SCAS#, SRAS, SMAA, SBS	Default	
X SMD[63:0], SDQM[7:0]	Default	
X SMAA#[7:4] (Rows 0/1)	Default	
X SMAB#[7:4] (Rows 2/3)	Default	
X SMAC#[7:4] (Rows 4/5)	Default	
X SCS[0]# (Row 0)	Default	
X SCS[1]# (Row 1)	Default	
X SCS[2]# (Row 2)	Default	
X SCS[3]# (Row 3)	Default	
X SCS[4]# (Row 4)	Default	
X SCS[5]# (Row 5)	Default	
X SCKE[0]# (Row 0)	Default	
X SCKE[1]# (Row 1)	Default	
X SCKE[2]# (Row 2)	Default	
X SCKE[3]# (Row 3)	Default	
X SCKE[4]# (Row 4)	Default	
X SCKE[5]# (Row 5)	Default	

↑↓→ ←:Move Enter:Select +/-/PU/PD:Value F10:Save ESC:Exit F1:General Help  
F5:Previous Values F6:Fail-Safe Defaults F7:Optimized Defaults

Figure 5: Advanced Chipset Features

- ※ These four items will be available when "SDRAM Timing Control" is set to Manual.
- ◆ This item will be shown when the system bus frequency is 133MHz.
- ♣ These three items will only be shown when you install GA-AIMM card.

- **Top Performance**

If you wish to maximize the performance of your system, set "Top Performance" as "Enabled".

Disabled	Disabled this function. <b>(Default Value)</b>
Enabled	Enabled Top Performance function.

- **SDRAM Timing Control**

Auto	Set SDRAM Timing Control to Auto. <b>(Default value)</b>
Manual	Set SDRAM Timing Control to Manual.

- **SDRAM CAS latency Time**

3	For Slower SDRAM DIMM module. <b>(Default Value)</b>
2	For Fastest SDRAM DIMM module.

- **SDRAM Cycle Time Tras/Trc**

7/9	Set SDRAM Tras/Trc Cycle time to 7/9 SCLKs. <b>(Default value)</b>
5/7	Set SDRAM Tras/Trc Cycle time to 5/7 SCLKs.

- **SDRAM RAS-to-CAS delay**

3	Set SDRAM RAS-to-CAS delay 3 SCLKs. <b>(Default value)</b>
2	Set SDRAM RAS-to-CAS delay 2 SCLKs.

- **SDRAM RAS Precharge Time**

3	Set SDRAM RAS Precharge Time to 3. <b>(Default value)</b>
2	Set SDRAM RAS Precharge Time to 2.

- **Delayed Transaction**

Disabled	Normal operation.
Enabled	For slow speed ISA device in system. <b>(Default value)</b>

- **On-Chip Video Window Size**

32MB	Set On-Chip Video Window Size to 32MB.
64MB	Set On-Chip Video Window Size to 64MB. <b>(Default value)</b>

- **AGP Graphics Aperture Size**

32 MB	Set AGP Graphics Aperture Size to 32MB.
64 MB	Set AGP Graphics Aperture Size to 64MB. <b>(Default Value)</b>

- **Display Cache Frequency**

100MHz	Set Display Cache Frequency to 100MHz.
133MHz	Set Display Cache Frequency to 133MHz. <b>(Default value)</b>

- **System Memory Frequency**

Auto	Set System Memory Frequency to Auto. <b>(Default value)</b>
100MHz	Set System Memory Frequency to 100MHz.
133MHz	Set System Memory Frequency to 133MHz.

- **Initial Display Cache**

Disabled	Disabled Initial Display Cache.
Enabled	Enabled Initial Display Cache. <b>(Default value)</b>

- **Display Cache Timing**

Auto	Set Display Cache Timing to Auto. <b>(Default value)</b>
Fast	Set Display Cache Timing to Fast.
Normal	Set Display Cache Timing to Normal.

- **SDRAM Buffer Strength**

Auto	Set SDRAM Buffer Strength to Auto. <b>(Default value)</b>
Manual	Set SDRAM Buffer Strength to Manual.

- **SWE#, SCAS#, SRAS#, SMAA, SBS**

Default	Set SWE#, SCAS#, SRAS#, SMAA, SBS to Default. <b>(Default value)</b>
1.7x	Set SWE#, SCAS#, SRAS#, SMAA, SBS to 1.7x.
0.7x	Set SWE#, SCAS#, SRAS#, SMAA, SBS to 0.7x.
1.0x	Set SWE#, SCAS#, SRAS#, SMAA, SBS to 1.0x.

- **SMD[63:0], SDQM[7:0]**

Default	Set SMD[63:0], SDQM[7:0] to Default. <b>(Default value)</b>
1.7x	Set SMD[63:0], SDQM[7:0] to 1.7x.
0.7x	Set SMD[63:0], SDQM[7:0] to 0.7x.
1.0x	Set SMD[63:0], SDQM[7:0] to 1.0x.

- **SMAA#[7:4] (Rows 0/1)**

Default	Set SMAA#[7:4] (Rows 0/1) to Default. <b>(Default value)</b>
2.7x	Set SMAA#[7:4] (Rows 0/1) to 2.7x.

1.7x	Set SMAA#[7:4] (Rows 0/1) to 1.7x.
1.0x	Set SMAA#[7:4] (Rows 0/1) to 1.0x.

- **SMAB#[7:4] (Rows 2/3)**

Default	Set SMAB#[7:4] (Rows 2/3) to Default. <b>(Default value)</b>
2.7x	Set SMAB#[7:4] (Rows 2/3) to 2.7x.
1.7x	Set SMAB#[7:4] (Rows 2/3) to 1.7x.
1.0x	Set SMAB#[7:4] (Rows 2/3) to 1.0x.

- **SMAC#[7:4] (Rows 4/5)**

Default	Set SMAC#[7:4] (Rows 4/5) to Default. <b>(Default value)</b>
2.7x	Set SMAC#[7:4] (Rows 4/5) to 2.7x.
1.7x	Set SMAC#[7:4] (Rows 4/5) to 1.7x.
1.0x	Set SMAC#[7:4] (Rows 4/5) to 1.0x.

- **SCS[0]# (Row 0)**

Default	Set SCS[0]# (Row 0) to Default. <b>(Default value)</b>
1.7x	Set SCS[0]# (Row 0) to 1.7x.
1.0x	Set SCS[0]# (Row 0) to 1.0x.

- **SCS[1]# (Row 1)**

Default	Set SCS[1]# (Row 1) to Default. <b>(Default value)</b>
1.7x	Set SCS[1]# (Row 1) to 1.7x.
1.0x	Set SCS[1]# (Row 1) to 1.0x.

- **SCS[2]# (Row 2)**

Default	Set SCS[2]# (Row 2) to Default. <b>(Default value)</b>
1.7x	Set SCS[2]# (Row 2) to 1.7x.
1.0x	Set SCS[2]# (Row 2) to 1.0x.

- **SCS[3]# (Row 3)**

Default	Set SCS[3]# (Row 3) to Default. <b>(Default value)</b>
1.7x	Set SCS[3]# (Row 3) to 1.7x.
1.0x	Set SCS[3]# (Row 3) to 1.0x.

- **SCS[4]# (Row 4)**

Default	Set SCS[4]# (Row 4) to Default. <b>(Default value)</b>
1.7x	Set SCS[4]# (Row 4) to 1.7x.
1.0x	Set SCS[4]# (Row 4) to 1.0x.

- **SCS[5]# (Row 5)**

Default	Set SCS[5]# (Row 5) to Default. <b>(Default value)</b>
1.7x	Set SCS[5]# (Row 5) to 1.7x.
1.0x	Set SCS[5]# (Row 5) to 1.0x.

- **SCKE[0]# (Row 0)**

Default	Set SCKE[0]# (Row 0) to Default. <b>(Default value)</b>
2.7x	Set SCKE[0]# (Row 0) to 2.7x.
1.7x	Set SCKE[0]# (Row 0) to 1.7x.

- **SCKE[1]# (Row 1)**

Default	Set SCKE[1]# (Row 1) to Default. <b>(Default value)</b>
2.7x	Set SCKE[1]# (Row 1) to 2.7x.
1.7x	Set SCKE[1]# (Row 1) to 1.7x.

- **SCKE[2]# (Row 2)**

Default	Set SCKE[2]# (Row 2) to Default. <b>(Default value)</b>
2.7x	Set SCKE[2]# (Row 2) to 2.7x.
1.7x	Set SCKE[2]# (Row 2) to 1.7x.

- **SCKE[3]# (Row 3)**

Default	Set SCKE[3]# (Row 3) to Default. <b>(Default value)</b>
2.7x	Set SCKE[3]# (Row 3) to 2.7x.
1.7x	Set SCKE[3]# (Row 3) to 1.7x.

- **SCKE[4]# (Row 4)**

Default	Set SCKE[4]# (Row 4) to Default. <b>(Default value)</b>
2.7x	Set SCKE[4]# (Row 4) to 2.7x.
1.7x	Set SCKE[4]# (Row 4) to 1.7x.



---

- **SCKE[5]# (Row 5)**

Default	Set SCKE[5]# (Row 5) to Default. <b>(Default value)</b>
2.7x	Set SCKE[5]# (Row 5) to 2.7x.
1.7x	Set SCKE[5]# (Row 5) to 1.7x.

## Integrated Peripherals

CMOS Setup Utility-Copyright( C ) 1984-2000 Award Software		
Integrated Peripherals		
On-Chip Primary PCI IDE	Enabled	Item Help
On-Chip Secondary PCI IDE	Enabled	
IDE Primary Master PIO	Auto	Menu Level ▶
IDE Primary Slave PIO	Auto	
IDE Secondary Master PIO	Auto	
IDE Secondary Slave PIO	Auto	
IDE Primary Master UDMA	Auto	
IDE Primary Slave UDMA	Auto	
IDE Secondary Master UDMA	Auto	
IDE Secondary Slave UDMA	Auto	
USB Controller	Enabled	
USB Keyboard Support	Disabled	
USB Mouse Support	Disabled	
Init Display First	PCI Slot	
AC97 Audio	Auto	
AC97 Modem	Auto	
IDE HDD Block Mode	Enabled	
POWER ON by Keyboard	Disabled	
X KB Power ON Password	Enter	
POWER ON by Mouse	Disabled	
Onboard FDC Controller	Enabled	
Onboard Serial Port 1	3F8/IRQ4	
Onboard Serial Port 2	2F8/IRQ3	
UART Mode Select	Normal	
× UR2 Duplex Mode	Half	
Onboard Parallel Port	378/IRQ7	
Parallel Port Mode	SPP	
AC BACK Function	Soft-Off	
◆ Game Port Address	201	
◆ Midi Port Address	330	
◆ Midi Port IRQ	10	
CIR Port Address	Disabled	
* CIR Port IRQ	11	

↑↓→←:Move Enter:Select +/-/PU/PD:Value F10:Save ESC:Exit F1:General Help  
F5:Previous Values F6:Fail-Safe Defaults F7:Optimized Defaults

Figure 6: Integrated Peripherals

- ※ This item will be available when "UART Mode Select" is set to IrDA or ASKIR.
- \* This item will be available when "CIR Port Address" is set to 310 or 320.
- ◆ These three items will be shown when there are only AC'97 CODEC sound.

- **On-Chip Primary PCI IDE**

Enabled	Enable onboard 1st channel IDE port. <b>(Default value)</b>
Disabled	Disable onboard 1st channel IDE port.

- **On-Chip Secondary PCI IDE**

Enabled	Enable onboard 2nd channel IDE port. <b>(Default value)</b>
Disabled	Disable onboard 2nd channel IDE port.

- **IDE Primary Master PIO (for onboard IDE 1st channel)**

Auto	BIOS will automatically detect the IDE HDD Accessing mode. <b>(Default value)</b>
Mode0-4	Manually set the IDE Accessing mode.

- **IDE Primary Slave PIO (for onboard IDE 1st channel)**

Auto	BIOS will automatically detect the IDE HDD Accessing mode. <b>(Default value)</b>
Mode0-4	Manually set the IDE Accessing mode.

- **IDE Secondary Master PIO (for onboard IDE 2nd channel)**

Auto	BIOS will automatically detect the IDE HDD Accessing mode. <b>(Default value)</b>
Mode0-4	Manually set the IDE Accessing mode.

- **IDE Secondary Slave PIO (for onboard IDE 2nd channel)**

Auto	BIOS will automatically detect the IDE HDD Accessing mode. <b>(Default value)</b>
Mode0-4	Manually set the IDE Accessing mode.

- **IDE Primary Master UDMA**

Auto	BIOS will automatically detect the IDE HDD Accessing mode. <b>(Default value)</b>
Disabled	Disable UDMA function.

- **IDE Primary Slave UDMA**

Auto	BIOS will automatically detect the IDE HDD Accessing mode. <b>(Default value)</b>
Disabled	Disable UDMA function.

- **IDE Secondary Master UDMA**

Auto	BIOS will automatically detect the IDE HDD Accessing mode. <b>(Default value)</b>
Disabled	Disable UDMA function.

- **IDE Secondary Slave UDMA**

Auto	BIOS will automatically detect the IDE HDD Accessing mode. <b>(Default value)</b>
Disabled	Disable UDMA function.

- **USB Controller**

Enabled	Enable USB Controller. <b>(Default value)</b>
Disabled	Disable USB Controller.

- **USB Keyboard Support**

Enabled	Enabled USB Keyboard Support.
Disabled	Disabled USB Keyboard Support. <b>(Default value)</b>

- **USB Mouse Support**

Enabled	Enabled USB Mouse Support.
Disabled	Disabled USB Mouse Support. <b>(Default value)</b>

- **Init Display First**

PCI Slot	Set Init Display First to PCI Slot. <b>(Default value)</b>
Onboard/AGP	Set Init Display First to onboard/AGP.

- **AC97 Audio**

Auto	BIOS will automatically detect onboard AC97 Audio or Creative CT5880 audio. <b>(Default value)</b>
Disabled	Disabled AC97 Audio.

- **AC97 Modem**

Auto	Bios will automatically detect onboard AC97 Modem. <b>(Default value)</b>
Disabled	Disabled AC97 Modem.

- **IDE HDD Block Mode**

Enabled	Enable IDE HDD Block Mode. <b>(Default value)</b>
Disabled	Disable IDE HDD Block Mode.

- **POWER ON by Keyboard**

Password	Enter from 1 to 5 characters to set the Keyboard Power On Password.
Disabled	Disabled this function. <b>(Default value)</b>
Keyboard 98	If your keyboard have "POWER Key" button, you can press the key to power on your system.

- **KB Power ON Password**

Enter	Enter from 1 to 5 characters to set the Keyboard Power On Password.
-------	---

- **POWER ON by Mouse**

Mouse Click	Double click on PS/2 mouse left button.
Disabled	Disabled this function. <b>(Default value)</b>

- **Onboard FDC Controller**

Enabled	Enable onboard FDC port. <b>(Default value)</b>
Disabled	Disable onboard FDC port.

- **Onboard Serial Port 1**

Auto	BIOS will automatically setup the port 1 address.
3F8/IRQ4	Enable onboard Serial port 1 and address is 3F8. <b>(Default value)</b>
2F8/IRQ3	Enable onboard Serial port 1 and address is 2F8.
3E8/IRQ4	Enable onboard Serial port 1 and address is 3E8.
2E8/IRQ3	Enable onboard Serial port 1 and address is 2E8.
Disabled	Disable onboard Serial port 1.

- **Onboard Serial Port 2**

Auto	BIOS will automatically setup the port 2 address.
3F8/IRQ4	Enable onboard Serial port 2 and address is 3F8.
2F8/IRQ3	Enable onboard Serial port 2 and address is 2F8. <b>(Default Value)</b>
3E8/IRQ4	Enable onboard Serial port 2 and address is 3E8.
2E8/IRQ3	Enable onboard Serial port 2 and address is 2E8.
Disabled	Disable onboard Serial port 2.

- **UART Mode Select**

(This item allows you to determine which Infra Red(IR) function of Onboard I/O chip)

ASKIR	Set onboard I/O chip UART to ASKIR Mode.
IrDA	Set onboard I/O chip UART to IrDA Mode.
SCR	Set onboard I/O chip UART to SCR Mode.
Normal	Set onboard I/O chip UART to Normal Mode. <b>(Default Value)</b>

- **UR2 Duplex Mode**

Half	IR Function Duplex Half. <b>(Default Value)</b>
Full	IR Function Duplex Full.

- **Onboard Parallel port**

378/IRQ7	Enable onboard LPT port and address is 378/IRQ7. <b>(Default Value)</b>
278/IRQ5	Enable onboard LPT port and address is 278/IRQ5.
Disabled	Disable onboard LPT port.
3BC/IRQ7	Enable onboard LPT port and address is 3BC/IRQ7.

- **Parallel Port Mode**

SPP	Using Parallel port as Standard Parallel Port. <b>(Default Value)</b>
EPP	Using Parallel port as Enhanced Parallel Port.
ECP	Using Parallel port as Extended Capabilities Port.
ECP+EPP	Using Parallel port as ECP & EPP mode.

- **AC Back Function**

Memory	This function depends on computer status.
Soft-Off	Set System Soft-Off Status. <b>(Default value)</b>
Full-On	Set System Full-On Status.

- **Game Port Address**

Disabled	Disabled this function.
201	Set onboard game port is 201. <b>(Default value)</b>
209	Set onboard game port is 209.

- **Midi Port Address**

Disabled	Disabled On Board Midi Port.
300	Set On Board Midi Port is 300.
330	Set On Board Midi Port is 330. <b>(Default value)</b>

---

- **Midi Port IRQ**

5	Set 5 for Midi Port IRQ.
10	Set 10 for Midi Port IRQ. <b>(Default value)</b>

- **CIR Port Address**

Disabled	Disabled this function. <b>(Default Value)</b>
310	Set CIR Port Address to 310.
320	Set CIR Port Address to 320.

- **CIR Port IRQ**

5	Set 5 for CIR Port IRQ.
11	Set 11 for CIR Port IRQ. <b>(Default Value)</b>

## Power Management Setup

CMOS Setup Utility-Copyright( C ) 1984-2000 Award Software Power Management Setup		
*ACPI Suspend Type	S1(PowerOn suspend)	Item Help
Video Off Method	DPMS	Menu Level ▶
Suspend Type	Stop Grant	
MODEM Use IRQ	4	
Suspend Mode	Disabled	
HDD Power Down	Disabled	
Soft-Off by PWR-BTTN	Instant-off	
Power LED in Suspend	Blinking	
Wake-Up by PCI card	Enabled	
ModemRingOn/WakeOnLan	Enabled	
*USB KB/Mouse Wake From S3	Disabled	
FAN Off In Suspend	Enabled	
CPU Thermal-Throttling	50%	
Resume by Alarm	Disabled	
X Date(of Month) Alarm	Everyday	
X Time(hh:mm:ss) Alarm	0 0 0	
** Reload Global Timer Events **		
Primary IDE 0	Disabled	
Primary IDE 1	Disabled	
Secondary IDE 0	Disabled	
Secondary IDE 1	Disabled	
FDD,COM,LPT Port	Disabled	
PCI PIRQ[A-D]#	Disabled	

↑↓→←:Move Enter:Select +/-/PU/PD:Value F10:Save ESC:Exit F1:General Help  
F5:Previous Values F6:Fail-Safe Defaults F7:Optimized Defaults

Figure 7: Power Management Setup

\*These two items will be shown when the system support STR function.

### ● ACPI Suspend Type

S1(PowerOn Suspend)	Set ACPI Suspend type to S1. (Default value)
S3(Suspend to RAM)	Set ACPI Suspend type to S3.



- **Video off Method**

V/H SYNC+Blank	BIOS will turn off V/H-SYNC when gets into Green mode for Green monitor power saving.
Blank Screen	BIOS will only black monitor when gets into Green mode.
DPMS	BIOS will use DPMS Standard to control VGA card. (The Green type VGA card will turn off V/H-SYNC automatically.) <b>(Default value)</b>

- **Suspend Type**

Stop Grant	Set Suspend type to stop grant. <b>(Default value)</b>
PwrOn Suspend	Set Suspend type to Power on Suspend.

- **MODEM Use IRQ**

NA	Set MODEM Use IRQ to NA.
3	Set MODEM Use IRQ to 3.
4	Set MODEM Use IRQ to 4. <b>(Default value)</b>
5	Set MODEM Use IRQ to 5.
7	Set MODEM Use IRQ to 7.
9	Set MODEM Use IRQ to 9.
10	Set MODEM Use IRQ to 10.
11	Set MODEM Use IRQ to 11.

- **Suspend Mode**

Disabled	Disabled Suspend Mode. <b>(Default value)</b>
1 min - 1 Hour	Setup the timer to enter Suspend Mode.

- **HDD Power Down**

Disabled	Disabled HDD Power Down mode function. <b>(Default value)</b>
1-15 mins.	Enabled HDD Power Down mode between 1 to 15 mins.

- **Soft-off by PWR-BTTN**

Instant-off	Soft switch ON/OFF for POWER ON/OFF. <b>(Default value)</b>
Delay 4 Sec.	Soft switch ON 4sec. for POWER OFF.

- **Power LED in Suspend**

Blinking	Set Power LED in Suspend at Blinking mode. <b>(Default value)</b>
On	Set Power LED in Suspend at On mode.
Off/Dual	Set Power LED in Suspend at Off/Dual color mode.

- **Wake-Up by PCI card**

Disabled	Disabled this function.
Enabled	Enabled wake-up by PCI card. <b>(Default value)</b>

- **ModemRingOn / WakeOnLan**

Disabled	Disabled these functions.
Enabled	Enabled these functions. <b>(Default value)</b>

- **USB KB/Mouse Wake From S3**

Disabled	Disabled this function. <b>(Default value)</b>
Enabled	Enabled USB KB/Mouse Wake From S3 function.

- **FAN Off In Suspend**

Disabled	Disabled this function.
Enabled	Stop CPU FAN when entering Suspend mode. <b>(Default value)</b>

- **CPU Thermal-Throttling**

87.5%	Monitor CPU Temp. will cause system slow down CPU Duty Cycle to 87.5%.
75.0%	Monitor CPU Temp. will cause system slow down CPU Duty Cycle to 75.0%.
62.5%	Monitor CPU Temp. will cause system slow down CPU Duty Cycle to 62.5%.
50.0%	Monitor CPU Temp. will cause system slow down CPU Duty Cycle to <b>50.0%. (Default value)</b>
37.5%	Monitor CPU Temp. will cause system slow down CPU Duty Cycle to 37.5%.
25.0%	Monitor CPU Temp. will cause system slow down CPU Duty Cycle to 25.0%.
12.5%	Monitor CPU Temp. will cause system slow down CPU Duty Cycle to 12.5%.

- **Resume by Alarm**

You can set "Resume by Alarm" item to Enabled and key in date/time to power on system.

Disabled	Disable this function. <b>(Default value)</b>
Enabled	Enable alarm function to POWER ON system.

If the default value is Enabled.

Date ( of Month) Alarm :	Everyday, 1~31
Time ( hh: mm: ss) Alarm :	(0~23) : (0~59) : (0~59)

- **Primary IDE 0/1**

Disabled	Disabled this function. <b>(Default value)</b>
Enabled	Enabled monitor Primary IDE 0/1 for Green event.

- **Secondary IDE 0/1**

Disabled	Disabled this function. <b>(Default value)</b>
Enabled	Enabled monitor Secondary IDE 0/1 for Green event.

- **FDD,COM,LPT Port**

Disabled	Disabled this function. <b>(Default value)</b>
Enabled	Enabled monitor FDD,COM,LPT for Green event.

- **PCI PIRQ[A-D] #**

Enabled	Monitor PCI PIRQ[A-D]# IRQ Active.
Disabled	Ignore PCI PIRQ[A-D]# IRQ Active. <b>(Default value)</b>

## PnP/PCI Configurations

CMOS Setup Utility-Copyright( C ) 1984-2000 Award Software PnP/PCI Configurations		
Reset Configuration Data	Disabled	Item Help
Resources Controlled By <b>X IRQ Resources</b>	Auto (ESCD) <b>Press Enter</b>	Menu Level ▶
PCI/VGA Palette Snoop	Disabled	When resources are controlled manually, assign each system interrupt a type, depending on the type of device using the interrupt

↑↓→ ← Move Enter: Select +/-PU/PD: Value F10: Save ESC: Exit F1: General Help  
F5: Previous Values F6: Fail-Safe Defaults F7: Optimized Defaults

Figure 8: PnP/PCI Configurations

- **Reset Configuration Data**

Disabled	Disabled this function. <b>(Default value)</b>
ESCD	Clear PnP information in ESCD.
DMI	Update Desktop Management Information data.
Both	Clear PnP information in ESCD & update DMI data.

- **Resources Controlled by**

Manual	User can set the PnP resource (I/O Address, IRQ & DMA channels) used by legacy ISA DEVICE.
Auto (ESCD)	BIOS automatically use these PnP rescuers. <b>(Default value)</b>

- **IRQ ( 3,4,5,7,9,10,11,12,15 )**

PCI Device	The resource is used by PCI device.
Reserved	Set the resource to reserved.

---

- **PCI/VGA Palette Snoop**

Enabled	For having Video Card on ISA Bus and VGA Card on PCI Bus.
Disabled	For VGA Card only. <b>(Default value)</b>

## PC Health Status

CMOS Setup Utility-Copyright( C ) 1984-2000 Award Software		
PC Health Status		
		Item Help
Reset Case Open Status	Disabled	
Case Opened	No	
VCORE	1.600 V	Menu Level ▶
VGTL	1.424 V	
VCC3	3.264 V	
+ 5V	5.053 V	
+12V	12.160V	
- 12V	-12.280 V	
5VSB(V)	5.026 V	
VBAT(V)	3.168 V	
Current CPU Temperature	31°C	
CPU FAN Speed	5443 RPM	
Power FAN Speed	0 RPM	
System FAN speed	0 RPM	
CPU Temperature Select	80°C/176°F	
Shutdown Temperature	Disabled	
CPU FAN Fail Alarm	Disabled	
Power FAN Fail Alarm	Disabled	
System FAN Fail Alarm	Disabled	

↑↓→ ← Move Enter:Select +/-PU/PD:Value F10:Save ESC:Exit F1:General Help  
F5:Previous Values F6:Fail-Safe Defaults F7:Optimized Defaults

Figure 9: PC Health Status

- **Reset Case Open Status**

- **Case Opened**

If the case is closed, "Case Opened" will show "No".

If the case have been opened, "Case Opened" will show "Yes".

If you want to reset "Case Opened" value, set "Reset Case Open Status" to "Enabled" and save CMOS, your computer will restart.

- **Current Voltage (V) VCORE / VGTL/ VCC3 / ±12V / +5V / 5VSB / VBAT**

Detect system's voltage status automatically.

- **Current CPU Temperature**

Detect CPU Temp. automatically.

- **CPU FAN / Power FAN / System FAN Speed (RPM)**

Detect Fan speed status automatically.

- **CPU Temperature Select (°C / °F)**

65°C / 149°F	Monitor CPU Temp. at 65°C / 149°F.
70°C / 158°F	Monitor CPU Temp. at 70°C / 158°F.
75°C / 167°F	Monitor CPU Temp. at 75°C / 167°F.
80°C / 176°F	Monitor CPU Temp. at 80°C / 176°F. <b>(Default value)</b>
85°C / 185°F	Monitor CPU Temp. at 85°C / 185°F.
90°C / 194°F	Monitor CPU Temp. at 90°C / 194°F.
95°C / 203°F	Monitor CPU Temp. at 95°C / 203°F.
Disabled	Disabled this function.

- **Shutdown Temperature (°C / °F)**

(This function will be effective only for the operating systems that support ACPI Function.)

Disabled	Normal Operation. <b>(Default value)</b>
65°C / 149°F	Monitor CPU Temp. at 65°C / 149°F, if Temp. > 65°C / 149°F system will automatically power off.
70°C / 158°F	Monitor CPU Temp. at 70°C / 158°F, if Temp. > 70°C / 158°F system will automatically power off.
75°C / 167°F	Monitor CPU Temp. at 75°C / 167°F, if Temp. > 75°C / 167°F system will automatically power off.
80°C / 176°F	Monitor CPU Temp. at 80°C / 176°F, if Temp. > 80°C / 176°F system will automatically power off.
85°C / 185°F	Monitor CPU Temp. at 85°C / 185°F, if Temp. > 85°C / 185°F system will automatically power off.
90°C / 194°F	Monitor CPU Temp. at 90°C / 194°F, if Temp. > 90°C / 194°F system will automatically power off.
95°C / 203°F	Monitor CPU Temp. at 95°C / 203°F, if Temp. > 95°C / 203°F system will automatically power off.

- **Fan Fail Alarm**

CPU / Power / System

Disabled	Fan Fail Alarm Function Disabled. <b>(Default value)</b>
Enabled	Fan Fail Alarm Function Enabled.

## Frequency/Voltage Control

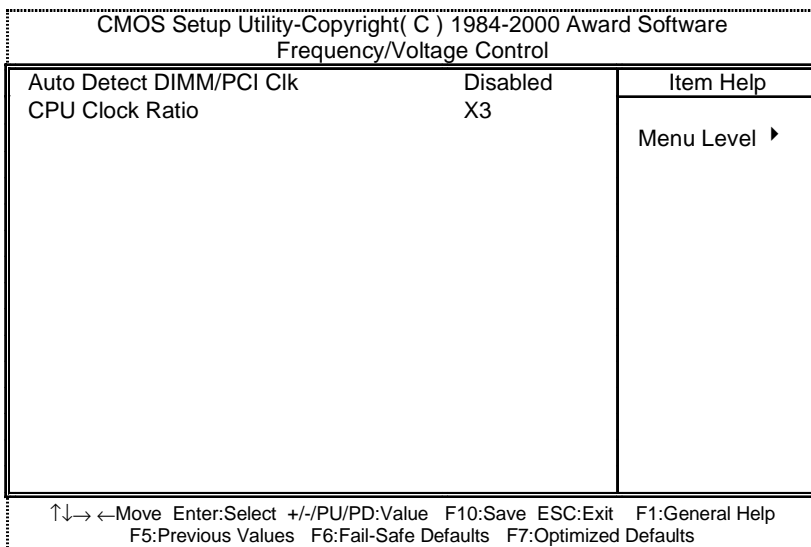

Figure 10: Frequency/Voltage Control

- **Auto Detect DIMM/PCI Clk**

Disabled	Disabled Auto Detect DIMM/PCI Clk. <b>(Default value)</b>
Enabled	Enabled Auto Detect DIMM/PCI Clk.

- **CPU Clock Ratio**

This option will not be shown if you are using a CPU with the locked ratio.

X3/X3.5/X4/X4.5/X5/X5.5/X6/X6.5/X7/X7.5/X8
--



## Load Fail-Safe Defaults

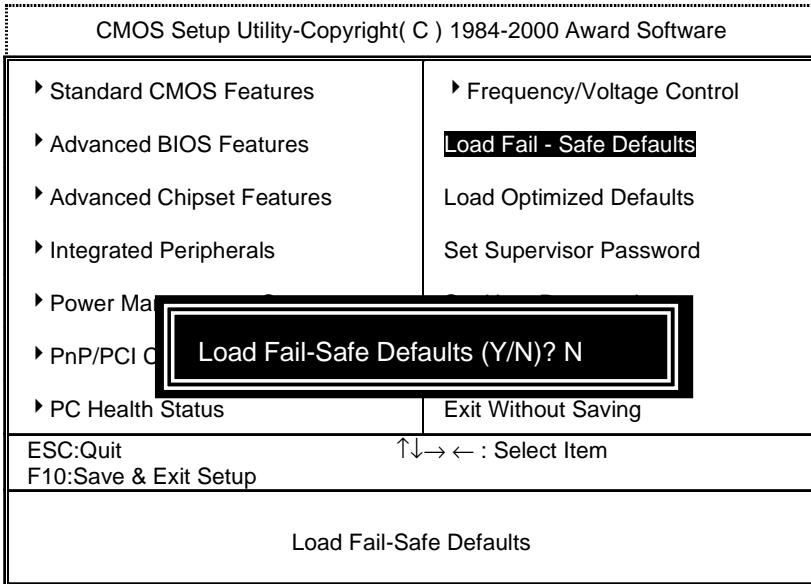

Figure 11: Load Fail-Safe Defaults

- **Load Fail-Safe Defaults**

Fail-Safe defaults contain the most appropriate values of the system parameters that allow minimum system performance.

## Load Optimized Defaults

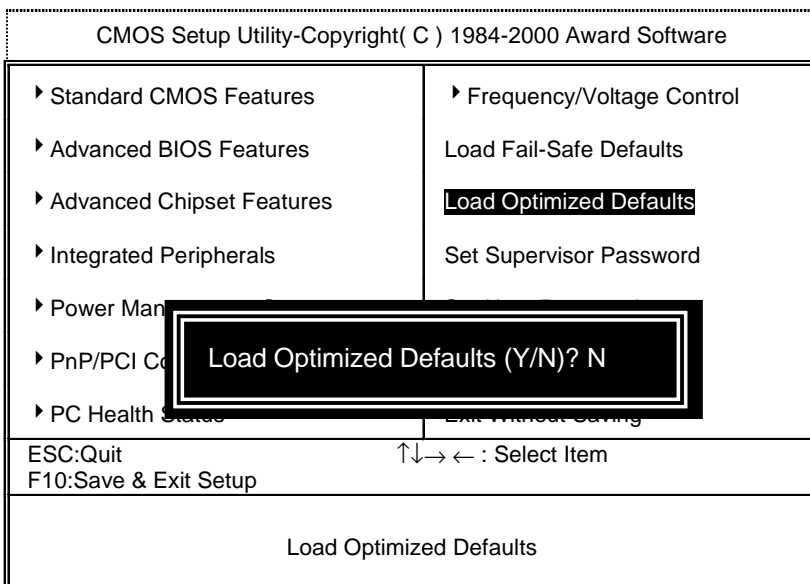

Figure 12: Load Optimized Defaults

- **Load Optimized Defaults**

Selecting this field loads the factory defaults for BIOS and Chipset Features which the system automatically detects.

## Set Supervisor / User Password

When you select this function, the following message will appear at the center of the screen to assist you in creating a password.

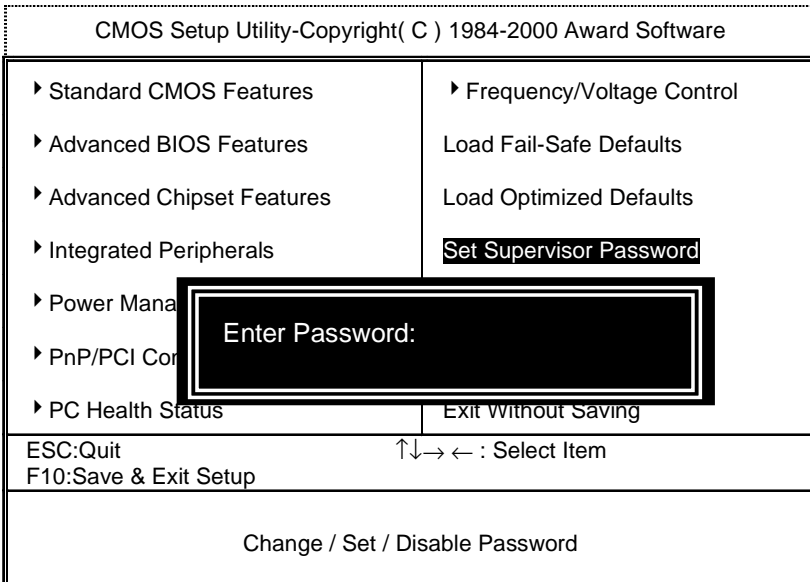

Figure 13: Password Setting

Type the password, up to eight characters, and press <Enter>. You will be asked to confirm the password. Type the password again and press <Enter>. You may also press <Esc> to abort the selection and not enter a password.

To disable password, just press <Enter> when you are prompted to enter password. A message **"PASSWORD DISABLED"** will appear to confirm the password being disabled. Once the password is disabled, the system will boot and you can enter Setup freely.

The BIOS Setup program allows you to specify two separate passwords: a **SUPERVISOR PASSWORD** and a **USER PASSWORD**. When disabled, anyone may access all BIOS Setup program function. When enabled, the Supervisor password is required for entering the BIOS Setup program and having full configuration fields, the User password is required to access only basic items.

If you select **"System"** at **"Security Option"** in Advanced BIOS Feature Menu, you will be prompted for the password every time the system is rebooted or any time you try to enter Setup Menu.

If you select **"Setup"** at **"Security Option"** in Advanced BIOS Feature Menu, you will be prompted only when you try to enter Setup.

## Save & Exit Setup

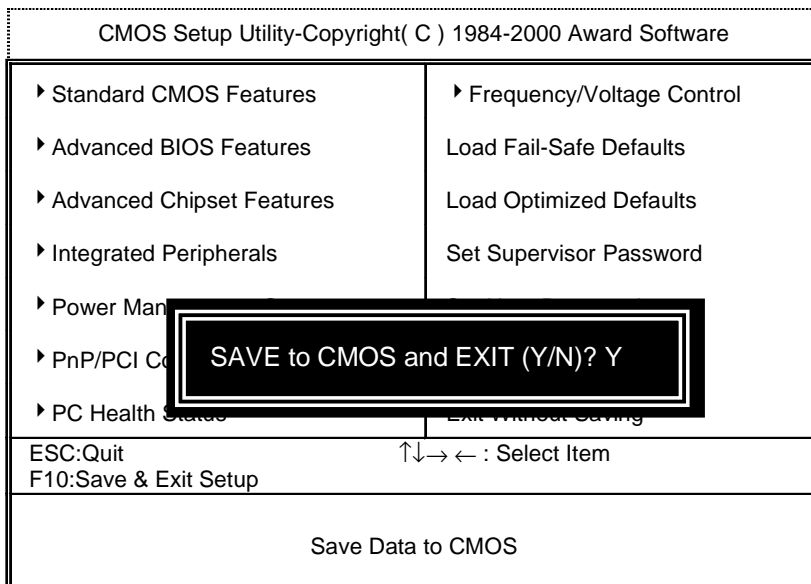

Figure 14: Save & Exit Setup

Type "Y" will quit the Setup Utility and save the user setup value to RTC CMOS.

Type "N" will return to Setup Utility.

## Exit Without Saving

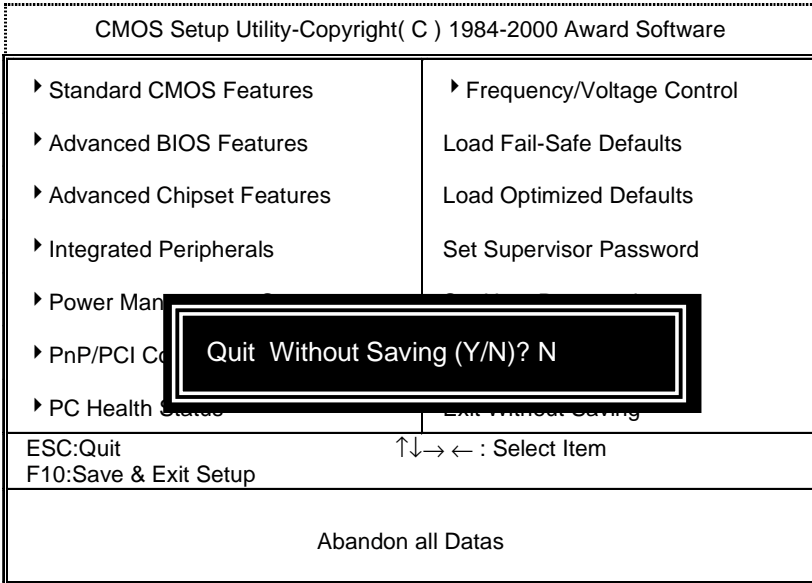

Figure 15: Exit Without Saving

Type "Y" will quit the Setup Utility without saving to RTC CMOS.

Type "N" will return to Setup Utility.

# Appendix

## Appendix A: Intel 815 Chipsets Driver Installation

### A. Windows 9x INF Update Utility

Insert the support CD that came with your motherboard into your CD-ROM drive or double-click the CD drive icon in **My Computer** to bring up the setup screen.

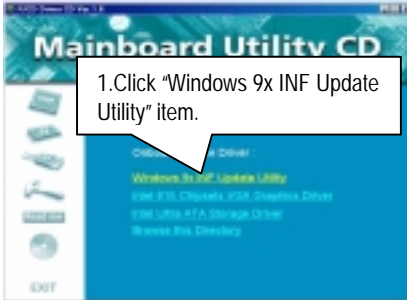

(1)

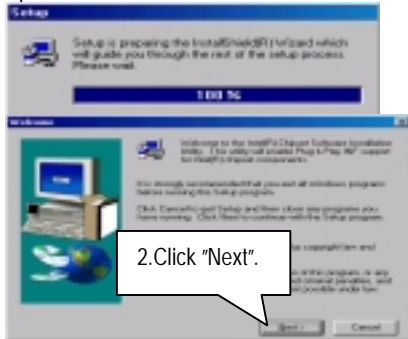

(2)

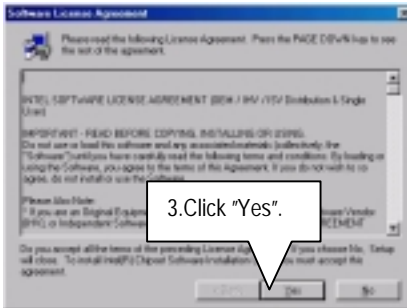

(3)

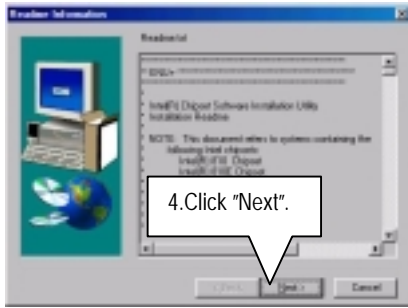

(4)



(5)

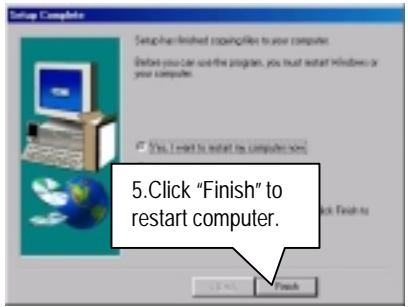

(6)

## B: Intel 815 Chipsets VGA Graphics Driver Installation

Insert the support CD that came with your motherboard into your CD-ROM drive or double-click the CD drive icon in **My Computer** to bring up the setup screen.

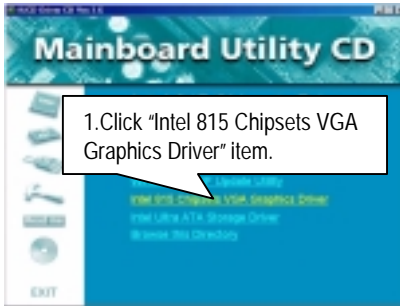

(1)

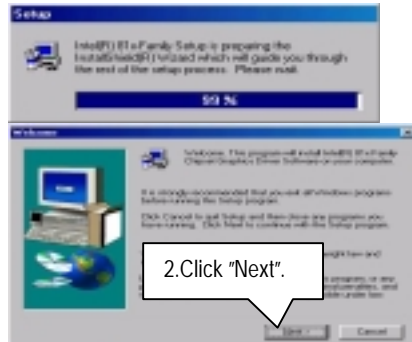

(2)

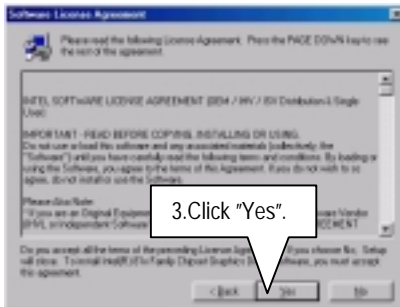

(3)



(4)



(5)

### C. Intel Ultra ATA Storage Driver Installation

Insert the support CD that came with your motherboard into your CD-ROM drive or double-click the CD drive icon in **My Computer** to bring up the setup screen.



(1)

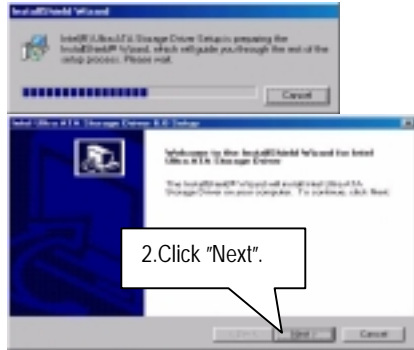

(2)

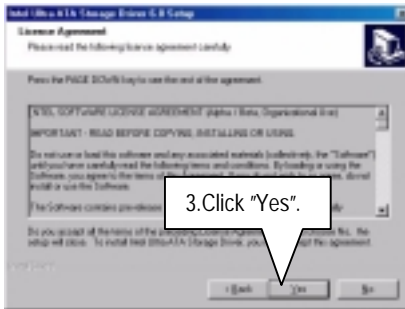

(3)

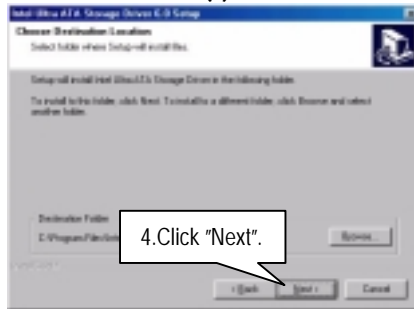

(4)

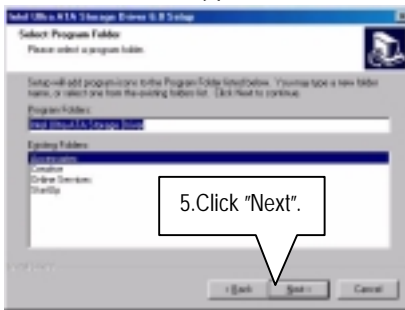

(5)

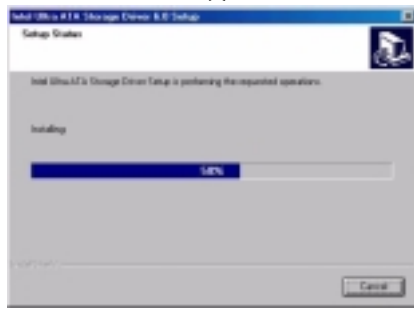

(6)



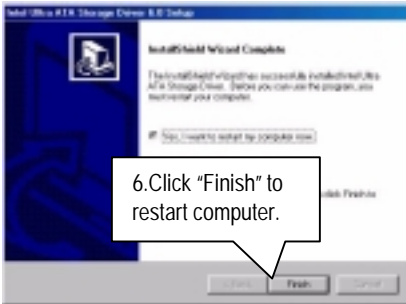

(7)

### Appendix B: Creative Sound Driver Installation (Optional)

Insert the support CD that came with your motherboard into your CD-ROM driver or double-click the CD driver icon in My Computer to bring up the screen.



(1)

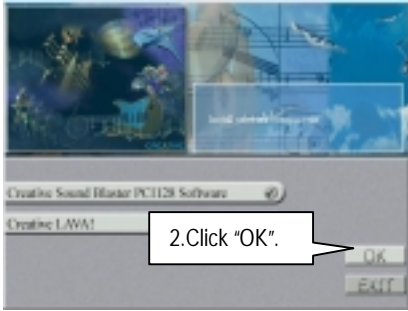

(2)

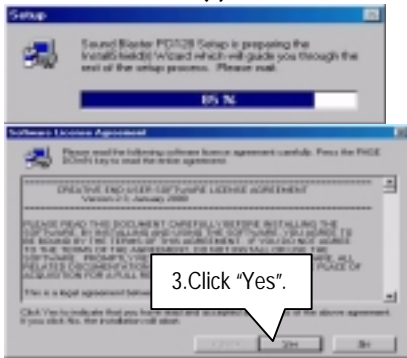

(3)

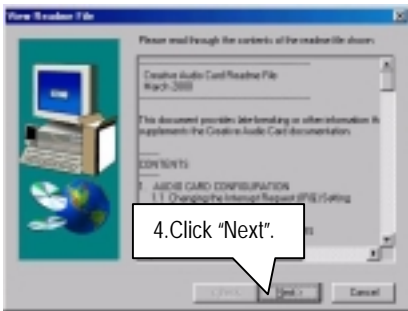

(4)

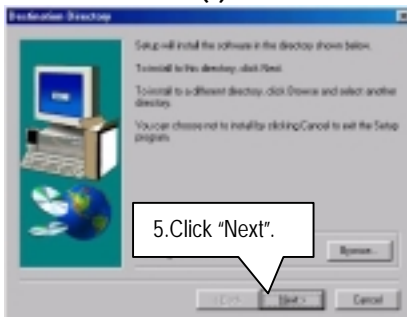

(5)

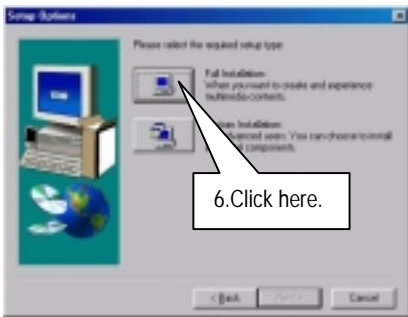

(6)

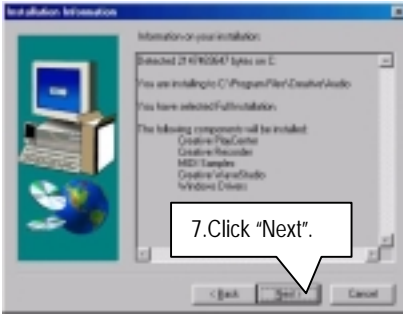

(7)



(8)

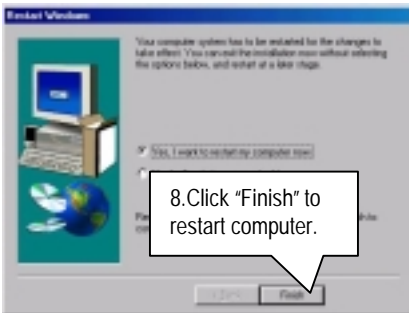

(9)

### Appendix C: SigmaTel AC'97 Audio Driver Installation (Optional)

Insert the support CD that came with your motherboard into your CD-ROM drive or double-click the CD drive icon in **My Computer** to bring up the setup screen.

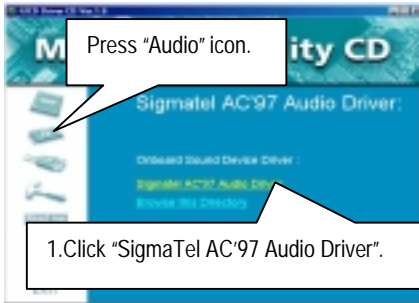

(1)

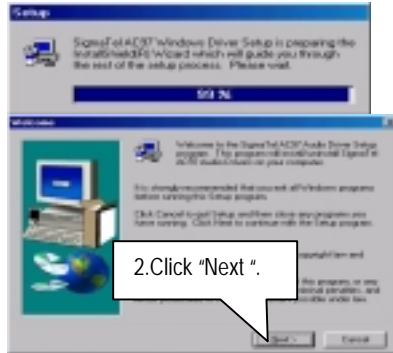

(2)

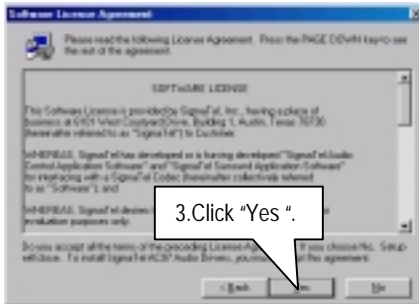

(3)

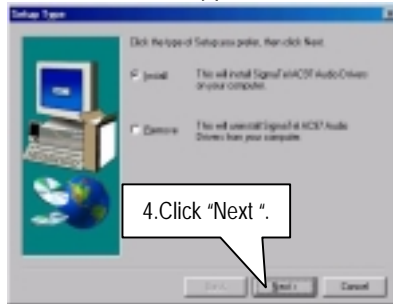

(4)



(5)

## Appendix D: EasyTuneIII™ Setup

Insert the support CD that came with your motherboard into your CD-ROM driver or double -click the CD driver icon in My Computer to bring up the screen.

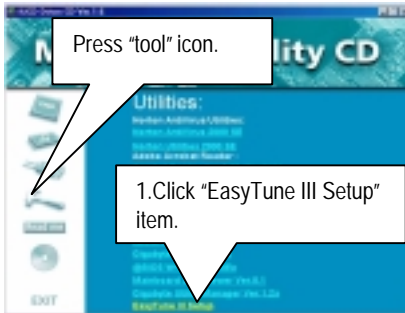

(1)

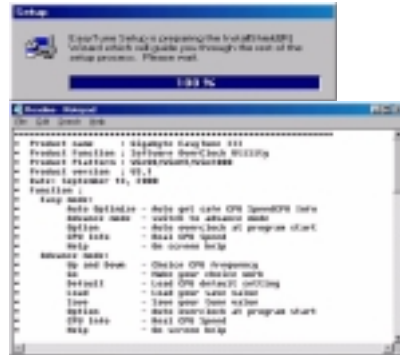

(2)

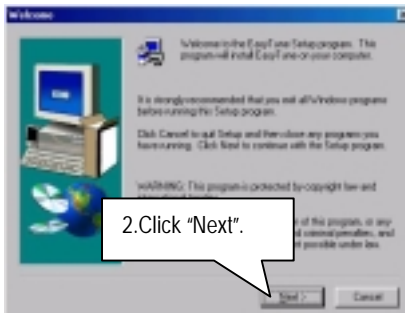

(3)

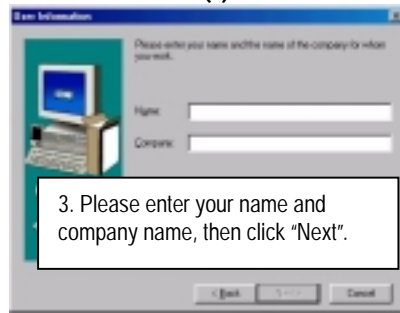

(4)

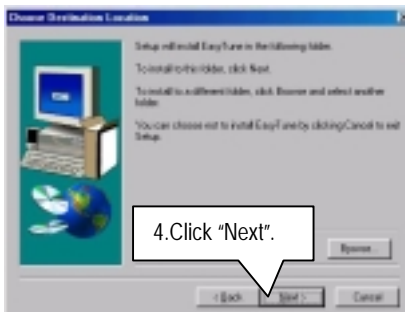

(5)

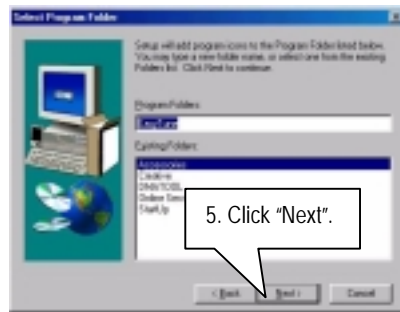

(6)

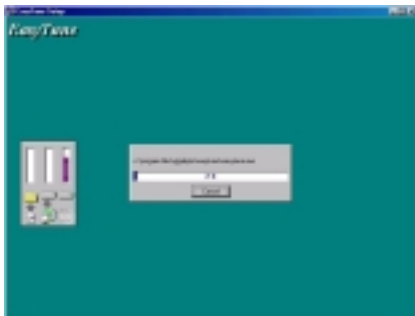

(7)

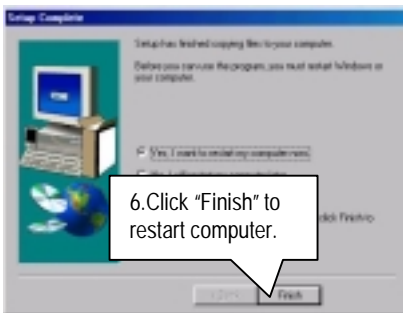

(8)

## Appendix E: BIOS Flash Procedure

BIOS update procedure:

If your OS is Win9X, we recommend that you used Gigabyte @BIOS™ Program to flash BIOS.

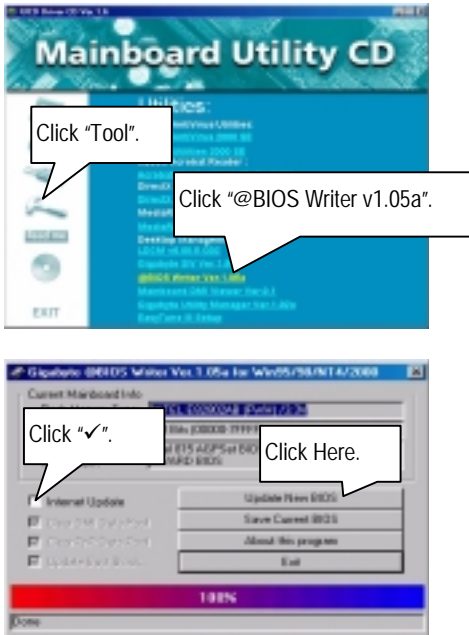

Methods and steps:

- I. Update BIOS through Internet
  - a. Click "Internet Update" icon
  - b. Click "Update New BIOS" icon
  - c. Select @BIOS™ sever ( "Gigabyte @BIOS™ sever 1 in Taiwan" and "Gigabyte @BIOS™ sever 2 in Taiwan" are available for now, the others will be completed soon)
  - d. Select the exact model name on your motherboard
  - e. System will automatically download and update the BIOS.

II. Update BIOS **NOT** through Internet:

- a. **Do not** click "Internet Update" icon
- b. Click "Update New BIOS"
- c. Please select "All Files" in dialog box while opening the old file.
- d. Please search for BIOS unzip file, downloading from internet or any other methods (such as: 60XM7.F1).
- e. Complete update process following the instruction.

III. Save BIOS

In the very beginning, there is "Save Current BIOS" icon shown in dialog box. It means to save the current BIOS version.

IV. Check out supported motherboard and Flash ROM:

In the very beginning, there is "About this program" icon shown in dialog box. It can help you check out which kind of motherboard and which brand of Flash ROM are supported.

Note:

- a. In method I, if it shows two or more motherboard's model names to be selected, please make sure your motherboard's model name again. Selecting name will cause the system unbooted.
- b. In method II, be sure that motherboard's model name in BIOS unzip file are the same as your motherboard's. Otherwise, your system won't boot.
- c. In method I, if the BIOS file you need cannot be found in @BIOS™ server, please go onto Gigabyte's web site for downloading and updating it according to method II.
- d. Please note that any intercorruption during updating will cause system unbooted



---

Or else you can select flash BIOS in DOS mode.

☛ Please check your **BIOS vendor (AMI or AWARD)**, your **motherboard name** and **PCB version** on the motherboard.

1. Format a bootable system floppy diskette by the command "**format a:/s**" in command mode.
2. Visit the Gigabyte website at [http:// www.gigabyte.com.tw](http://www.gigabyte.com.tw) ,Select the BIOS file you need and download it to your bootable floppy diskette.
3. Insert the bootable diskette containing the BIOS file into the floppy diskette driver.
4. Assuming that the floppy diskette driver is A, reboot the system by using the A: driver. At the A: > prompt, run the BIOS upgraded file by executing the Flash BIOS utility and the BIOS file with its appropriate extension.

Example: *(AMI tool) (Where 6oxm7.f1 is name of the BIOS file name)*

A:>flashxxx.exe 6oxm7.f1 ↵

Example: *(Award tool) (Where 6oxm7.f1 is name of the BIOS file name)*

A:>Awdflash.exe 6oxm7.f1 ↵

5. Upon pressing the <Enter> key, a flash memory writer menu will appear on screen. Enter the new BIOS file name with its extension filename into the text box after file name to program.
6. If you want to save the old BIOS file(perform as soon as system is operational, this is recommended), select Y to **DO YOU WANT TO SAVE BIOS**, then type the old BIOS filename and the extension after filename to save: This option allows you to copy the contents of the flash memory chip onto a diskette, giving you a backup copy of the original motherboard BIOS in case you need to re-install it. Select N to **DO YOU WANT TO SAVE BIOS**, if you don't want to save the old BIOS file.
7. After the decision to save the old BIOS file or not is made, select Y to **ARE YOU SURE TO PROGRAM** when the next menu appear; wait until a message showing Power Off or Reset the system appears. Then turn off your system.
8. Remove the diskette and restart your system.
9. Hold down <Delete> key to enter BIOS setup. You must select "Load Setup BIOS Default" to activate the new BIOS, then you may set other item from the main menu.

## Appendix F: Issues To Beware Of When Installing AMR

Please use inverse AMR card like the one in order to avoid mechanical problem. (See Figure A)

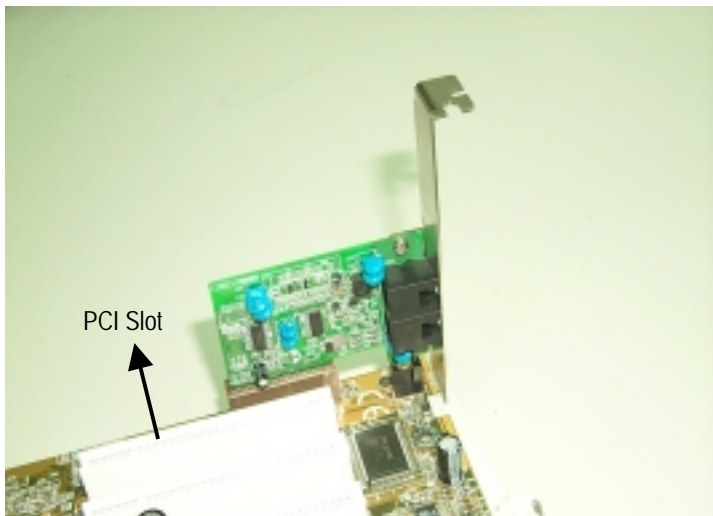

Figure A: Inverse AMR Card (Default)

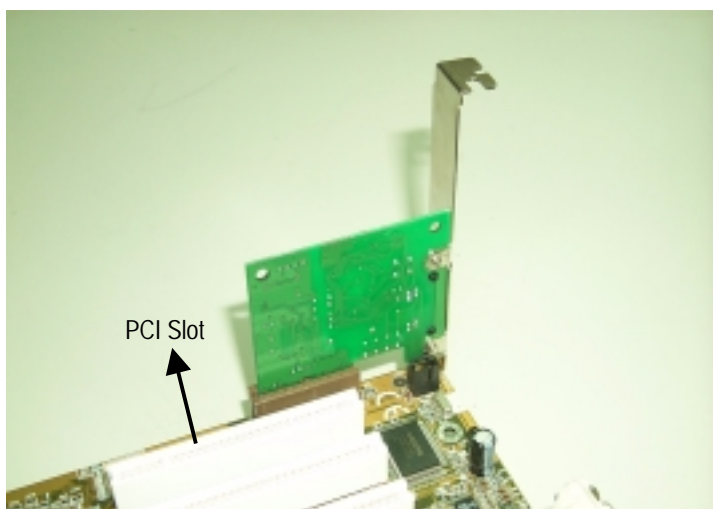
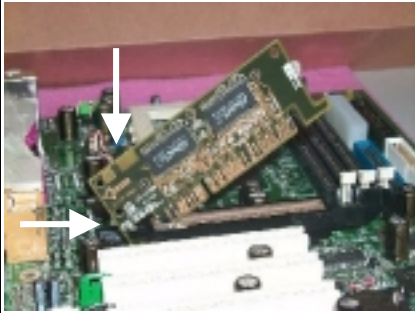

Figure B: Non inverse AMR Card

**Appendix G: Issues To Beware Of When Installing GA-AIMM Card (Optional)****Install:**

1. Insert the card at an angle as shown below. Push the card forward a little making sure it's tight.



2. Push the card down as per picture below.

**Remove:**

3. Push the extruding piece of the AGP retention module out. Pull the card from the tip.

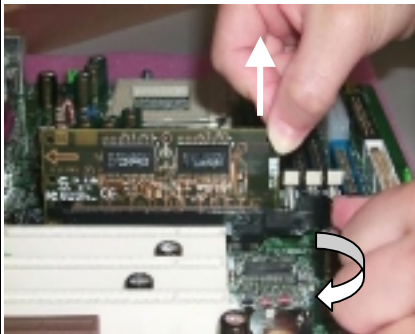

4. Lift up the card and remove from the slot.

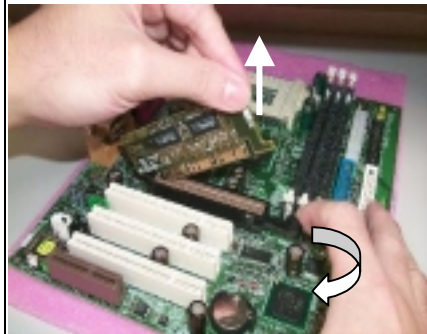

## Appendix H: Acronyms

Acronyms	Meaning
ACPI	Advanced Configuration and Power Interface
POST	Power-On Self Test
LAN	Local Area Network
ECP	Extended Capabilities Port
APM	Advanced Power Management
DMA	Direct Memory Access
MHz	Megahertz
ESCD	Extended System Configuration Data
CPU	Central Processing Unit
SMP	Symmetric Multi-Processing
USB	Universal Serial Bus
OS	Operating System
ECC	Error Checking and Correcting
IDE	Integrated Dual Channel Enhanced
SCI	Special Circumstance Instructions
LBA	Logical Block Addressing
EMC	Electromagnetic Compatibility
BIOS	Basic Input / Output System
SMI	System Management Interrupt
IRQ	Interrupt Request
NIC	Network Interface Card
A.G.P.	Accelerated Graphics Port
S.E.C.C.	Single Edge Contact Cartridge
LED	Light Emitting Diode
EPP	Enhanced Parallel Port
CMOS	Complementary Metal Oxide Semiconductor
I/O	Input / Output
ESD	Electrostatic Discharge
OEM	Original Equipment Manufacturer
SRAM	Static Random Access Memory
VID	Voltage ID
DMI	Desktop Management Interface
MIDI	Musical Interface Digital Interface
IOAPIC	Input Output Advanced Programmable Input Controller
DIMM	Dual Inline Memory Module
DRAM	Dynamic Random Access Memory
PAC	PCI A.G.P. Controller
AMR	Audio Modem Riser

To be continued...

---

Acronyms	Meaning
PCI	Peripheral Component Interconnect
RIMM	Rambus in-line Memory Module
DRM	Dual Retention Mechanism
ISA	Industry Standard Architecture
MTH	Memory Translator Hub
CRIMM	Continuity RIMM