

## FCC Compliance Statement:

<p style="text-align: center;"><b>DECLARATION OF CONFORMITY</b> Per FCC Part 2 Section 2.107(a)</p> <p style="text-align: center;"><b>FC</b></p> <p>Responsible Party Name: G.B.T. INC.</p> <p style="text-align: center;">Address: 18365 Valley Blvd., Suite#A LA Puente, CA 91744</p> <p style="text-align: center;">Phone/Fax No: (818) 854-9338 / (818) 854-9339</p> <p>hereby declares that the product</p> <p style="text-align: center;">Product Name: Mother Board</p> <p style="text-align: center;">Model Number: GA-6EXDR</p> <p>Conforms to the following specifications:</p> <p style="text-align: center;">FCC Part 15, Subpart B, Section 15.107(a) and Section 15.109(a), Class B Digital Device.</p> <p><b>Supplementary Information:</b></p> <p style="text-align: center;"><small>This device complies with part 15 of the FCC Rules. Operation is subject to the following two conditions: (1) This device may not cause harmful and (2) this device must accept any interference received, including that may cause undesired operation.</small></p> <p>Representative Person's Name: <u>ERIC LI</u></p> <p>Signature: <u>Eric Li</u></p> <p>Date: <u>May 20, 2001</u></p>
---

This equipment has been tested and found to comply with limits for a Class B digital device, pursuant to Part 15 of the FCC rules. These limits are designed to provide reasonable protection against harmful interference in residential installations. This equipment generates, uses, and can radiate radio frequency energy, and if not installed and used in accordance with the instructions, may cause harmful interference to radio communications. However, there is no guarantee that interference will not occur in a particular installation. If this equipment does cause interference to radio or television equipment reception, which can be

determined by turning the equipment off and on, the user is encouraged to try to correct the interference by one or more of the following measures:

- Reorient or relocate the receiving antenna
- Move the equipment away from the receiver
- Plug the equipment into an outlet on a circuit different from that to which the receiver is connected
- Consult the dealer or an experienced radio/television technician for additional suggestions

You are cautioned that any change or modifications to the equipment not expressly approve by the party responsible for compliance could void Your authority to operate such equipment.

This device complies with Part 15 of the FCC Rules. Operation is subjected to the following two conditions 1) this device may not cause harmful interference and 2) this device must accept any interference received, including interference that may cause undesired operation.

# Declaration of Conformity

We, Manufacturer/Importer  
(full address)

**G.B.T. Technology Trading GmbH**  
**Ausschlagler Weg 41, 1F, 20537 Hamburg, Germany**

declare that the product  
( description of the apparatus, system, installation to which it refers)

**Mother Board**  
GA-6EXDR

is in conformity with  
(reference to the specification under which conformity is declared)  
in accordance with 89/336 EEC-EMC Directive

- |   |  |  |  |
|---|--|--|--|
| <input type="checkbox"/> EN 55011   | Limits and methods of measurement of radio disturbance characteristics of industrial, scientific and medical (ISM high frequency equipment                 | <input type="checkbox"/> EN 61000-3-2*<br><input checked="" type="checkbox"/> EN60555-2          | Disturbances in supply systems caused by household appliances and similar electrical equipment "Harmonics"   |
| <input type="checkbox"/> EN55013  | Limits and methods of measurement of radio disturbance characteristics of broadcast receivers and associated equipment                                     | <input type="checkbox"/> EN61000-3-3*<br><input checked="" type="checkbox"/> EN60555-3           | Disturbances in supply systems caused by household appliances and similar electrical equipment "Voltage fluctuations"                                  |
| <input type="checkbox"/> EN 55014   | Limits and methods of measurement of radio disturbance characteristics of household electrical appliances, portable tools and similar electrical apparatus | <input checked="" type="checkbox"/> EN 50081-1<br><input checked="" type="checkbox"/> EN 50082-1 | Generic emission standard Part 1: Residual, commercial and light industry<br>Generic immunity standard Part 1: Residual, commercial and light industry |
| <input type="checkbox"/> EN 55015   | Limits and methods of measurement of radio disturbance characteristics of fluorescent lamps and luminaries   | <input type="checkbox"/> EN 55081-2  | Generic emission standard Part 2: Industrial environment   |
| <input type="checkbox"/> EN 55020   | Immunity from radio interference of broadcast receivers and associated equipment   | <input type="checkbox"/> EN 55082-2  | Generic immunity standard Part 2: Industrial environment   |
| <input checked="" type="checkbox"/> EN 55022  | Limits and methods of measurement of radio disturbance characteristics of information technology equipment   | <input type="checkbox"/> ENV 55104   | Immunity requirements for household appliances tools and similar apparatus   |
| <input type="checkbox"/> DIN VDE 0855<br><input type="checkbox"/> part 10<br><input type="checkbox"/> part 12 | Cabled distribution systems; Equipment for receiving and/or distribution from sound and television signals   | <input type="checkbox"/> EN 50091- 2   | EMC requirements for uninterruptible power systems (UPS)   |

CE marking



(EC conformity marking)

**The manufacturer also declares the conformity of above mentioned product with the actual required safety standards in accordance with LVD 73/23 EEC**

- |                                   |   |                                     |   |
|-----------------------------------|---|-------------------------------------|---|
| <input type="checkbox"/> EN 60065 | Safety requirements for mains operated electronic and related apparatus for household and similar general use | <input type="checkbox"/> EN 60950   | Safety for information technology equipment including electrical business equipment |
| <input type="checkbox"/> EN 60335 | Safety of household and similar electrical appliances   | <input type="checkbox"/> EN 50091-1 | General and Safety requirements for uninterruptible power systems (UPS)             |

Manufacturer/Importer

Signature : Rex Lin  
Name : Rex Lin

(Stamp)

Date : May, 20, 2001

**6EXDR**

**Socket 370 Dual Processors Motherboard**

# **USER'S MANUAL**

Socket 370 Dual Processors Motherboard  
REV. 1.0 First Edition  
R-10-01-010430



## How This Manual Is Organized

This manual is divided into the following sections:

<b>1) Revision History</b>	Manual revision information
<b>2) Item Checklist</b>	Product item list
<b>3) Features</b>	Product information & specification
<b>4) Hardware Setup</b>	Instructions on setting up the motherboard
<b>5) Performance &amp; Block Diagram</b>	Product performance & block diagram
<b>6) Advanced Networking Services</b>	For Windows NT*4 and Windows 2000 (Teaming)
<b>7) BIOS Setup</b>	Instructions on setting up the BIOS software
<b>8) Appendix</b>	General reference



## Table Of Content

Revision History	P.1
Item Checklist	P.2
Summary of Features	P.3
6EXDR Motherboard Layout	P.5
Page Index for CPU Speed Setup/Connectors/Panel and Jumper Definition	P.6
Performance List	P.26
Block Diagram	P.27
Advanced Networking Services for Windows NT* 4 and Windows 2000 (Teaming)	P.28
Memory Installation	P.34
DIMM QVL List	P.34
Page Index for BIOS Setup	P.35
Appendix	P.60

## Revision History

Revision	Revision Note	Date
1.0	Initial release of the 6EXDR motherboard user's manual.	Apr. 2001

The author assumes no responsibility for any errors or omissions that may appear in this document nor does the author make a commitment to update the information contained herein. Third-party brands and names are the property of their respective owners.



---

## Item Checklist

- The 6EXDR motherboard
- Cable for SCSI U160 / ATA33 / Floppy device
- Diskettes or CD (Driver CD) for motherboard driver & utility
- 6EXDR user's manual
- Internal COM B Cable (Optional)
- Internal Chassis Cable (Optional)

## Summary Of Features

Form Factor	<ul style="list-style-type: none"> <li>• 30.4 cm x 24.3 cm ATX size form factor, 6 layers PCB.</li> <li>• 250 watt or higher power supply required</li> </ul>
CPU	<ul style="list-style-type: none"> <li>• Dual ZIF PGA370 Socket</li> <li>• Intel Pentium III FC-PGA</li> <li>• Two onboard VRMs (VRM 8.4 spec V2.5)</li> <li>• 100/133 MHz Front Side Bus support</li> </ul>
Chipset	<ul style="list-style-type: none"> <li>• ServerWorks ServerSet™III LE Chipset</li> <li>• Integrated I/O APIC</li> <li>• Full peer-to-peer support</li> </ul>
Memory	<ul style="list-style-type: none"> <li>• Four 25° angled 168-pin DIMM sockets</li> <li>• Support only 3.3V PC-100/PC133 registered 72 bit ECC type SDRAM DIMM.</li> <li>• Maximum up to 4 GB.</li> </ul>
I/O Controller	<ul style="list-style-type: none"> <li>• NS PC97317VUL Super I/O Chip</li> </ul>
Slots	<ul style="list-style-type: none"> <li>• Two PCI slots supports 33MHz &amp; PCI 2.2 compliant</li> <li>• Two PCI-64bit/66Mhz slots &amp; PCI 2.2 compliant</li> <li>• PCI Raiser Card <b>(Optional)</b></li> </ul>
On-Board IDE	<ul style="list-style-type: none"> <li>• Support for UDMA33 IDE and ATAPI compliant devices.</li> <li>• Supports for dual channel master mode and up to 4 enhance IDE devices.</li> </ul>
On-Board SCSI	<ul style="list-style-type: none"> <li>• Integrated LSI SYM53C1010-66 Chipset with 64b/66MHz</li> <li>• Supports dual channel Ultra160 SCSI</li> <li>• 160MBps throughput and up to 15 devices per channel</li> <li>• Channel A and B: 68-pin connectors</li> </ul>
On-Board Peripherals	<ul style="list-style-type: none"> <li>• 1 floppy port supports 2 FDD with 360K, 720K, 1.2M, 1.44M and 2.88M bytes</li> <li>• 1 parallel ports supports Normal/EPP/ECP mode</li> <li>• 2 9-pin UART serial ports (COM 1 &amp; COM 2) <b>(one serial port via cable- optional)</b></li> <li>• 4 USB ports</li> </ul>
On-Board VGA	<ul style="list-style-type: none"> <li>• Onboard Ati Rage XL PCI Accelerator</li> <li>• Standard 15-pin analog VGA port</li> <li>• 8MB SDRAM frame buffer</li> </ul>

To be continued...

On-Board LAN	<ul style="list-style-type: none"> <li>• Integrated two Intel 82559 LAN controllers</li> <li>• 10/100Mbps data transfer rate per controller</li> <li>• 3 pin Wake on LAN (S1 and S5 state)</li> <li>• Adapter Fault Tolerance (AFT) and Adaptive Load Balancing (ALB)</li> </ul>
Hardware Monitor	<ul style="list-style-type: none"> <li>• CPU 1/ CPU 2 fan revolution detect</li> <li>• CPU 1/ CPU 2 temperature detect</li> <li>• System voltage detect</li> <li>• CPU overheat shutdown detect</li> <li>• 3pin fan speed monitoring headers</li> <li>• 2pin chassis intrusion header</li> <li>• CPU, Voltages and system temperature monitoring</li> <li>• Built-in Wake on Modem header</li> </ul>
PS/2 Connector	<ul style="list-style-type: none"> <li>• PS/2<sup>®</sup> Keyboard interface and PS/2<sup>®</sup> Mouse interface</li> </ul>
BIOS	<ul style="list-style-type: none"> <li>• Licensed AMI BIOS, 4M bits flash ROM</li> <li>• Auto configure IDE HDD type</li> <li>• User setting for hardware monitoring</li> <li>• DMI 2.0 compliant</li> <li>• Multiple boot (<b>Optional</b>)</li> </ul>
Additional Features	<ul style="list-style-type: none"> <li>• Support Internal / External Modem Ring On</li> <li>• Poly fuse for PS/2<sup>®</sup> and USB devices over-current protection</li> </ul>

# 6EXDR Motherboard Layout

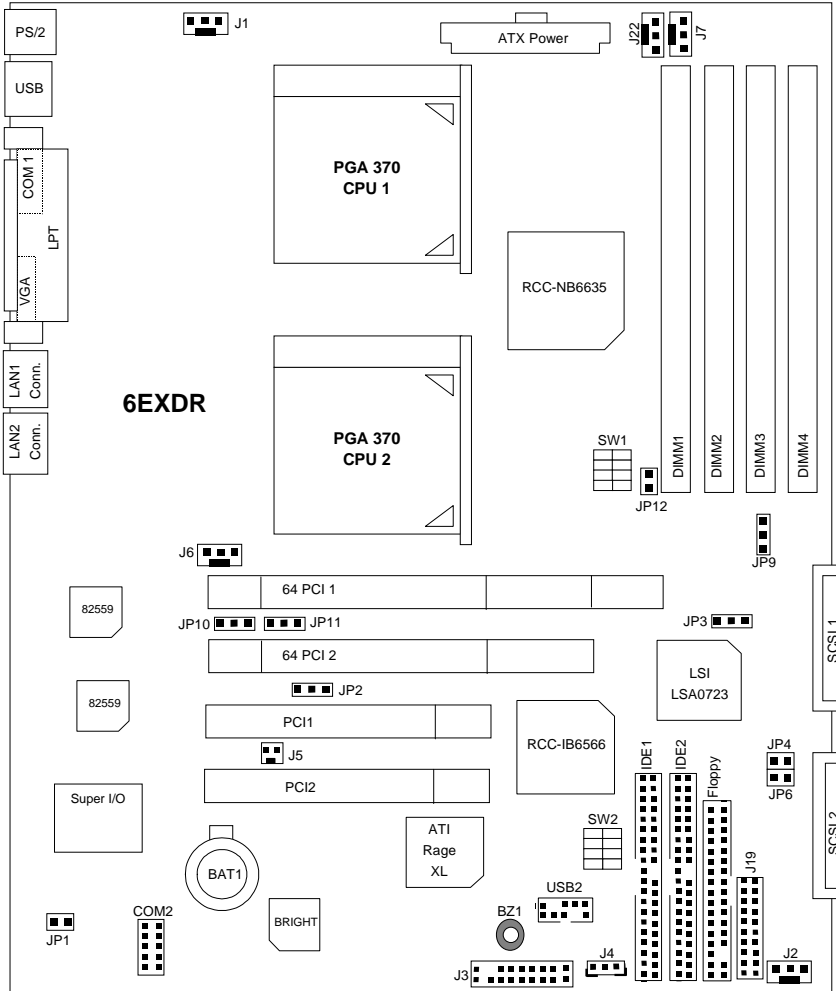

	Page
Page Index for CPU Speed Setup/Connectors/Panel and Jumper Definition	
CPU Speed Setup	P.7
Connectors	P.11
ATX Power	P.11
COM 1 / VGA / LPT Port	P.11
COM 2 Port	P.12
Floppy Port	P.12
IDE 1(Primary) / IDE 2(Secondary) Port	P.13
J1 (CPU1 Fan)	P.13
J2 (Panel Fan)	P.14
J4 (Wake On LAN)	P.14
J5 (Ring Power On)	P.15
J6 (CPU2 Fan)	P.15
J7 (Power Fan1)	P.16
J19 (System Interface Connector)	P.16
J22 (Power Fan2)	P.17
LAN connector	P.17
PS/2 Keyboard & PS/2 Mouse Connector	P.18
SCSI1 (Primary)/SCSI2 (Secondary)	P.18
USB1( USB 1 Connector)	P.19
USB2(Front USB Connector)	P.19
Panel and Jumper Definition	P.20
J3 (2x11 Pins Jumper)	P.20
JP1 (Fireware White Protect)	P.21
JP2 (VGA Enable Jumper)	P.21
JP3 (SCSI Enable Jumper)	P.22
JP4 (SCSI TERM A)	P.22
JP6 (SCSI TERM B)	P.23
JP10 (LAN1 Enable Selection)	P.23
JP11 (LAN2 Enable Selection)	P.24
JP12 (Case Open)	P.24
SW2 (Pole1_On Password Enable / Pole4_On CMOS Clear)	P.25
BAT1 (Battery)	P.25

## CPU Speed Setup

The system bus speed is depended on CPU. (Supported 100,133MHz). The user can change the DIP switch (**SW1**) and Jumper (**JP9**) selection to set up the CPU speed for 600MHz – 1GHz processor.

⚠️ The CPU speed must match with the frequency ratio. It will cause system hanging up if the frequency ratio is higher than that of CPU.

SW1:

FREQ. RATIO	DIP SWITCH			
	1	2	3	4
X 6	0	0	0	X
X 6.5	X	0	0	X
X 7	0	X	0	X
X 7.5	X	X	0	X
X 8	0	0	X	X
X 8.5	X	0	X	X
X 9	0	X	X	X
X 9.5	X	X	X	X

⚠️ For double CPU use, the same CPU must be used in CPU socket 1 and socket 2.  
(The same stepping, FSB, ratio)

⚠️ Intel Processor all have locked Frequency Multiple, so you can not change the CPU Frequency Multiple.

1. Pentium® !!! 600/100MHz FSB

Pentium® !!! 800/133MHz FSB

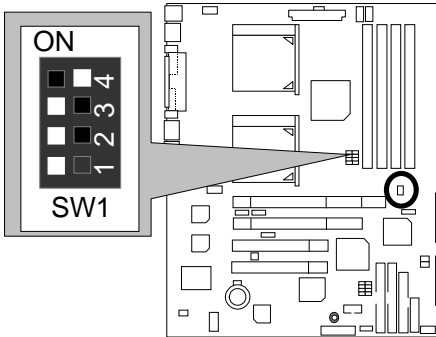

You can change the DIP switch (**SW1**) selection to set up the CPU Speed.  
 The CPU frequency RATIO is 6.  
 The FSB is 100MHz, than CPU speed is 600MHz.  
 The FSB is 133MHz, than CPU Speed is 800MHz.

	JP9	JP9
1	<input type="checkbox"/> <input type="checkbox"/>	100 MHz
	<input type="checkbox"/> <input type="checkbox"/>	Auto (Default)

2. Pentium® !!! 650/100MHz FSB

Pentium® !!! 866/133MHz FSB

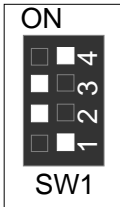

3. Pentium® !!! 700/100MHz FSB

Pentium® !!! 933/133MHz FSB

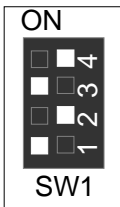

- 4. Pentium® !!! 750/100MHz FSB  
Pentium® !!! 1GHz/133MHz FSB

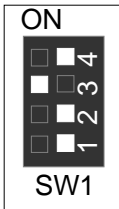

- 5. Pentium® !!! 800/100MHz FSB

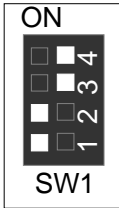

- 6. Pentium® !!! 850/100MHz FSB

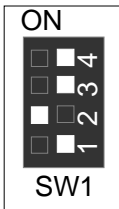

- 7. Pentium® !!! 533/133MHz FSB

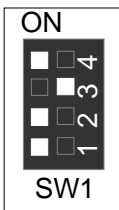



8. Pentium® !!! 600/133MHz FSB

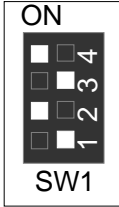

## Connectors

### ATX Power

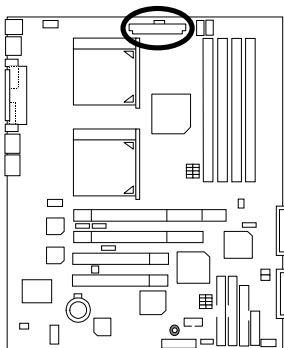

20										11
10										1

Pin No.	Definition
3,5,7,13, 15-17	GND
1,2,11	3.3V
4,6,19,20	VCC
10	+12V
12	-12V
18	-5V
8	Power Good
9	5V SB stand by+5V
14	PS-ON(Soft On/Off)



**Please note:**

AC power cord should only be connected to your power supply unit after ATX power cable and other related devices are firmly connected to the mainboard.

### COM 1 / VGA / LPT Port

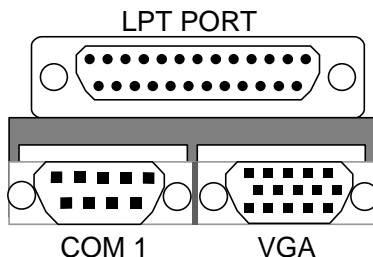
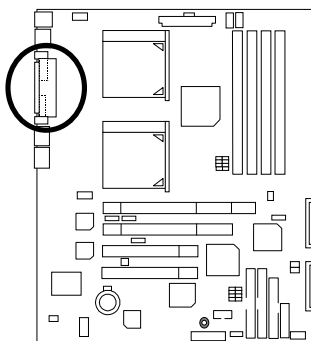

**Please note:**

This mainboard supports 1 standard COM port ,1 VGA port and 1 LPT port. Device like printer can be connected to LPT port ; mouse and modem etc can be connected to COM ports.

### COM 2 Port

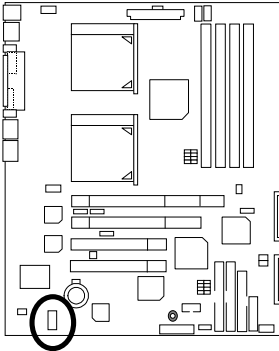

COM 2

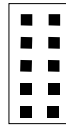

### FDD 1 : Floppy Port

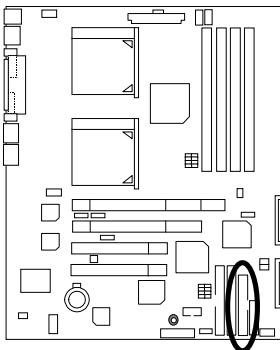

FDD1



Red Line

### IDE1 (Primary), IDE2 (Secondary) Port

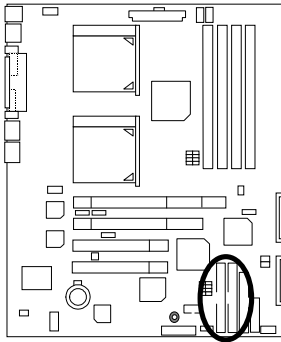

Red Line

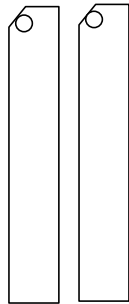

### J1 : CPU1 Fan

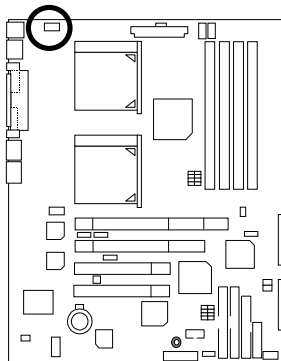

Pin No.	Definition
1	Control
2	+12V
3	SENSE

## J2 : Panel Fan

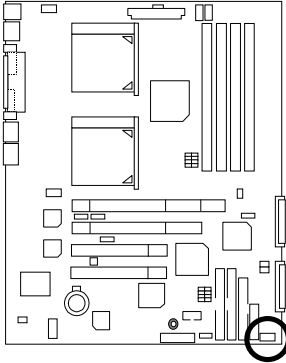

Pin No.	Definition
1	Control
2	+12V
3	SENSE

## J4 : Wake On LAN

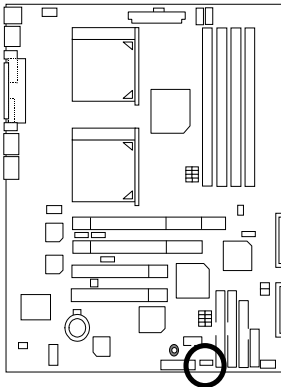

Pin No.	Definition
1	+5V SB
2	GND
3	Signal

### J5 : Ring Power On (Internal Modem Card Wake Up)

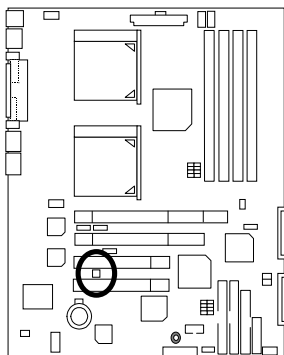

Pin No.	Definition
1	Signal
2	GND

### J6 : CPU2 Fan

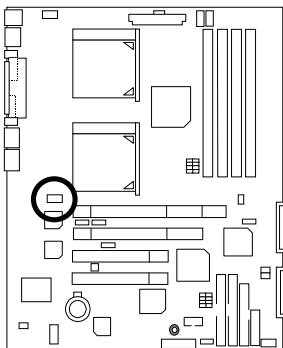

Pin No.	Definition
1	Control
2	+12V
3	SENSE

## J7 : Power Fan 1

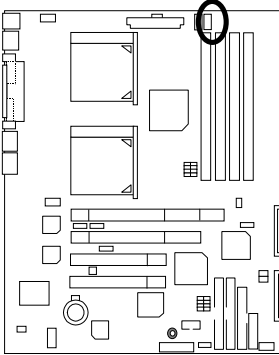

Pin No.	Definition
1	Control
2	+12V
3	SENSE

## J19 : System Interface Connector

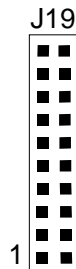
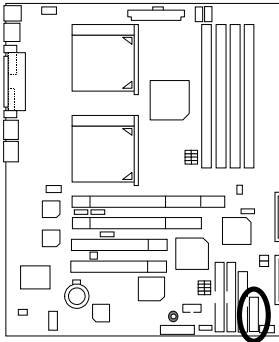

### J22 : Power Fan 2

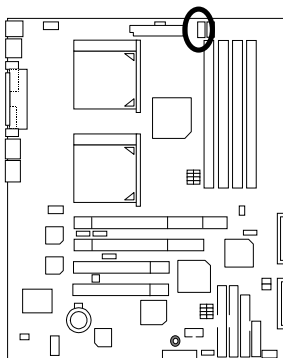

Pin No.	Definition
1	Control
2	+12V
3	SENSE

### LAN Connector

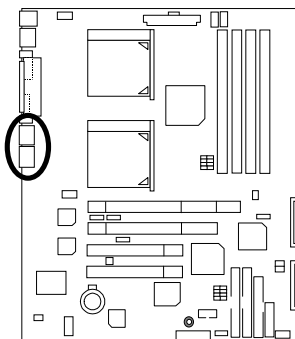

LAN1

LAN2

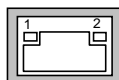
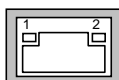

(LAN Active LED)

1 – Yellow LED  
(LAN Active LED)

2 – Green LED  
(LAN Link LED)  
100Mb--Light  
10 Mb--Blind



## PS/2 Keyboard & PS/2 Mouse Connector

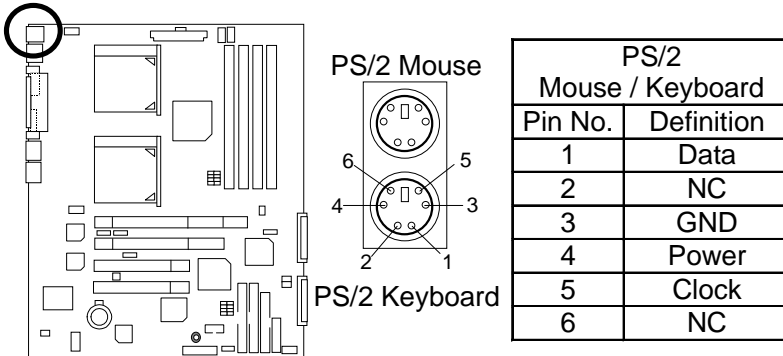

**Please note:**  
This mainboard supports standard PS/2 keyboard and PS/2 mouse interface connector.

## SCSI 1 (Primary), SCSI 2 (Secondary) Port

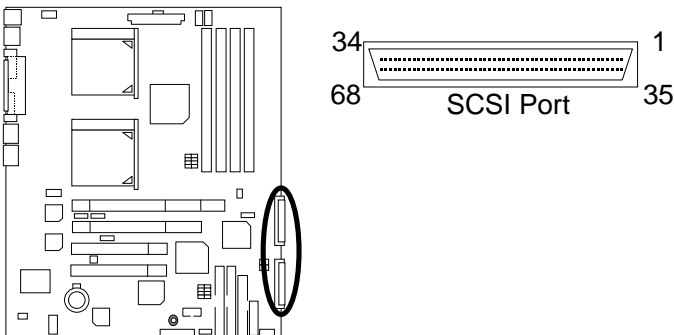

## USB1: USB 1 Connector

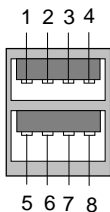
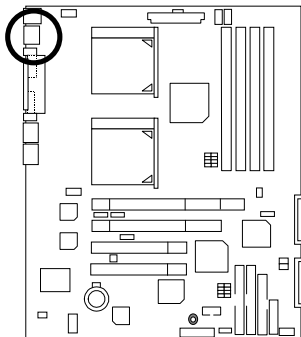

Pin No.	Definition
1	USB V0
2	USB D0-
3	USB D0+
4	GND
5	USB V1
6	USB D1-
7	USB D1+
8	GND



**Please note:**

Before you connect your device(s) into USB connector(s), please make sure your device(s) has a standard USB interface like, USB keyboard, mouse, scanner, zip, buzzer... Also make sure your OS supports USB controller (Win 95 w/ USB supperment, Win98, Windows 2000, Windows ME, Win NT w/ SP 6). If your OS does not support USB controller, please contact OS vendor for passible patch or driver upgrade. For more information please contact your OS or device(s) vendors.

## USB2 : Front USB Connector

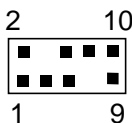
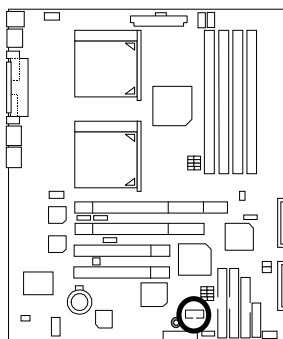

Pin No.	Definition
1	5V-SB
2	GND
3	USB D2-
4	NC
5	USB D2+
6	USB D3+
7	NC
8	USB D3-
9	GND
10	5V-SB



**Please note:**

Be careful with the polarity of the front panel USB connector. Check the pin assignment while you connect the front panel USB cable. Please contact your nearest dealer for optional front panel USB cable.

## Panel And Jumper Definition

### J3 : 2x11 Pins Jumper

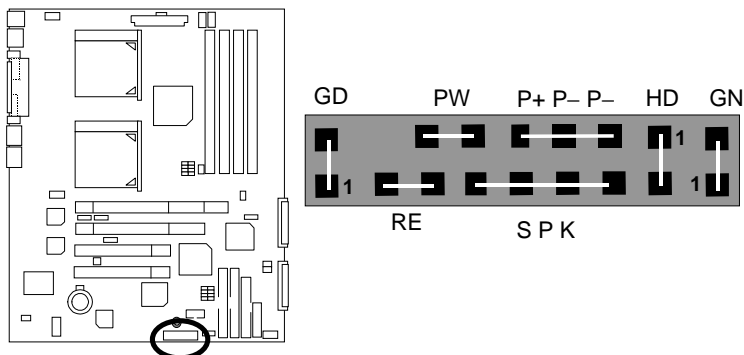

GN (Green Switch)	Open: Normal Operation Close: Entering Green Mode
GD (Green LED)	Pin 1: LED anode(+) Pin 2: LED cathode(-)
HD (IDE Hard Disk Active LED)	Pin 1: LED anode(+) Pin 2: LED cathode(-)
SPK (Speaker Connector)	Pin 1: VCC(+) Pin 2- Pin 3: NC Pin 4: Data(-)
RE (Reset Switch)	Open: Normal Operation Close: Reset Hardware System
P+P-P-(Power LED)	Pin 1: LED anode(+) Pin 2: LED cathode(-) Pin 3: LED cathode(-)
PW (Soft Power Connector)	Open: Normal Operation Close: Power On/Off



**Please note:**

Please connect the power LED, PC speaker, reset switch and power switch etc of your chassis front panel to the front panel jumper according to the pin assignment above.

## JP1 : Fireware Write Protect

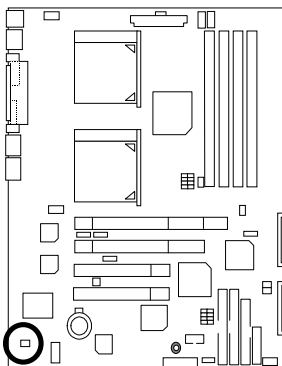

Disable  
(Default)



Enable

Pin No.	Definition
Open	Disable (Default)
Close	Enable



**Please note:**

To flash/upgrade BIOS on this MB JP1 must be opened. We recommend JP1 to be set to "close", whenever user is not try to flash/upgrade the BIOS.

## JP2 : VGA Enable jumper

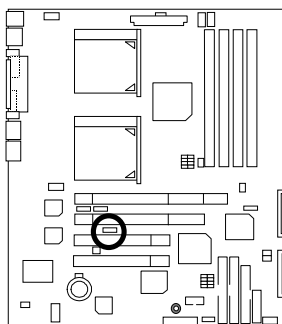

Enabled  
(Default)



Disabled

Pin No.	Definition
1-2 close	Onboard VGA Enable (Default)
2-3 close	Onboard VGA Disable

JP3 : SCSI Enable jumper

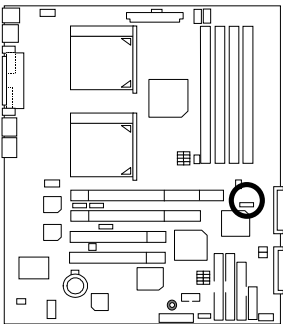

Pin No.	Definition
1-2 close	Onboard SCSI Enable (Default)
2-3 close	Onboard SCSI Disable

JP4 : SCSI TERM A

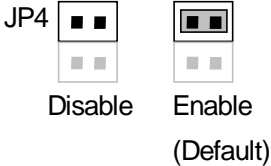
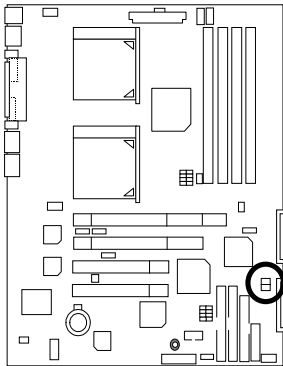

Pin No.	Definition
Close	Enable (Default)
Open	Disable

### JP6 : SCSI TERM B

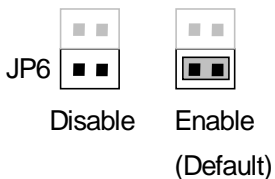
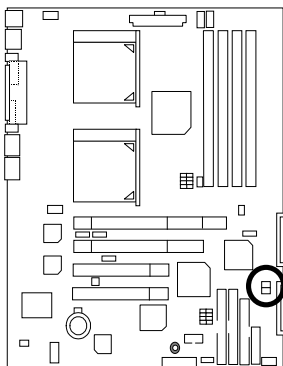

Pin No.	Definition
Close	Enable (Default)
Open	Disable

### JP10 : LAN1 Enable Selection

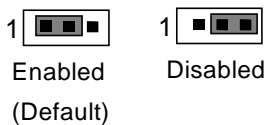
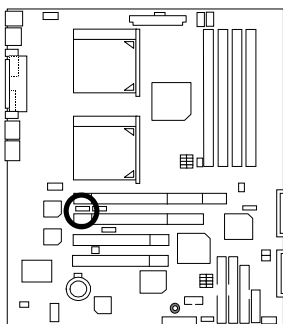

Pin No.	Definition
1-2 close	Onboard LAN1 Enabled (Default)
2-3 close	Onboard LAN1 Disabled

JP11 : LAN2 Enable Selection

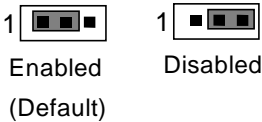
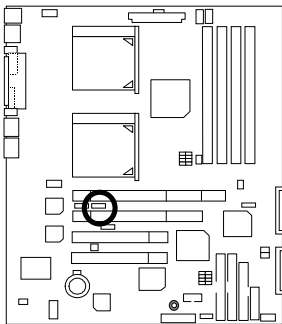

Pin No.	Definition
1-2 close	Onboard LAN2 Enabled (Default)
2-3 close	Onboard LAN2 Disabled

JP12 : Case Open

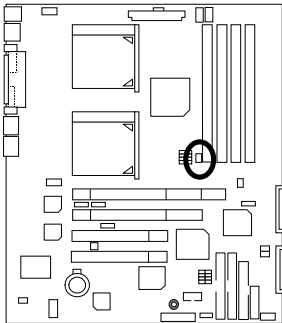

Pin No.	Definition
1	Signal
2	GND

SW2 : Pole1\_ON Password Enable/ Pole4\_ON CMOS Clear

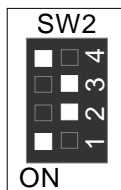
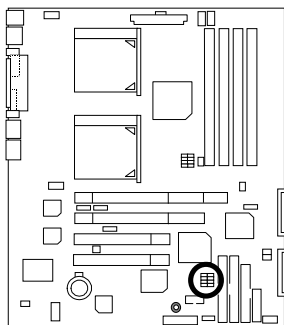

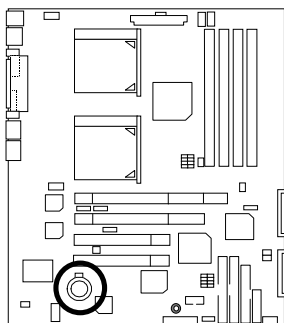

Pin No.	Definition
Pole4_Off	CMOS Clear
Pole3_ON	NC
Pole2_ON	NC
Pole1_ON	Password Enable

BAT1 : Battery



**CAUTION**

-  Danger of explosion if battery is incorrectly replaced.
-  Replace only with the same or equivalent type recommended by the manufacturer.
-  Dispose of used batteries according to the manufacturer's instructions.



## Performance List

The following performance data list is the testing results of some popular benchmark testing programs.

These data are just referred by users, and there is no responsibility for different testing data values gotten by users. (The different Hardware & Software configuration will result in different benchmark testing results.)

- CPU Intel Socket 370 Pentium® III 1G Hz x 2 processor
- DRAM (128 x 1)MB SDRAM (Micro MT48LC16M4A2-75)
- CACHE SIZE 256KB include in CPU (Intel Pentium® III)
- DISPLAY Onboard ATI Rage XL
- STORAGE Onboard SCSI (Seagate ST39204LW 9GB)
- O.S. Windows 2000 + SP1
- DRIVER Display Driver at 1024x768x16bitx75MHz

Processor	Intel Pentium® III Socket 370 1G Hz x 2 (133x7.5)
<b>Winbench99 (ver.1.2g)</b>	
Business Disk	6230
Hi-End Disk	18500
Business Graphics	137
Hi-End Graphics	456
<b>Winstone2001</b>	
Business Winstone	37.1
Content Creation Winstone	41.3

# Block Diagram

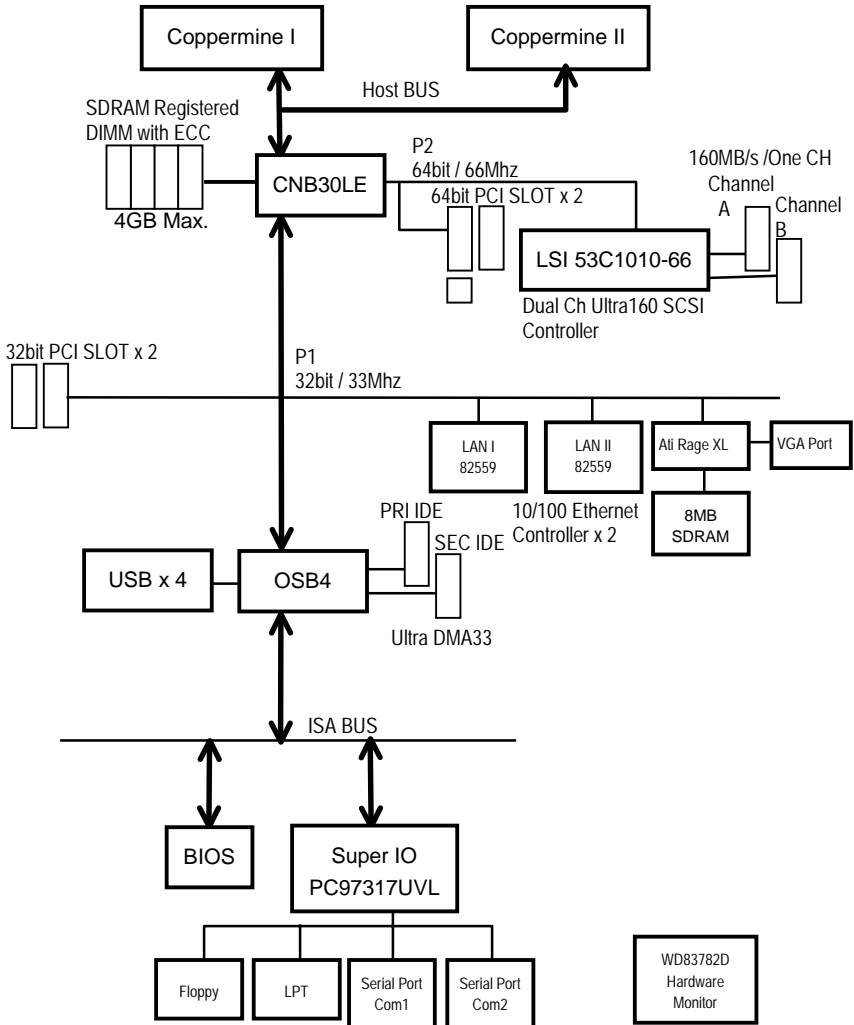

---

## Advanced Networking Services for Windows NT\* 4 and Windows 2000 (Teaming)

- Please make sure the Intel LAN Adapter teaming driver Install complete.  
(☞ refer to page 62)

### 1. Intel LAN Adapter Teaming

Adapter Teaming Installation Notes for the PRO/100 S Server Adapter Under Windows NT 4.0 and Windows 2000.

**Note:** Teaming requires Intel® Server Adapters.

#### *1.1 Overview*

The PRO/100 S adapter provides several options for increasing throughput and fault tolerance when running Windows NT 4.0 or Windows 2000 :

- **Adapter Fault Tolerance (AFT)** - provides automatic redundancy for your adapter. If the primary adapter fails, the secondary takes over.
- **Adaptive Load Balancing (ALB)** - creates a team of 2 - 8 adapters to increase transmission throughput. Also includes the AFT option. Works with any 100BASE-TX switch.
- **Fast EtherChannel\* (FEC)** - creates a team of 2 or 4 adapters to increase transmission and reception throughput. Also includes the AFT option. Requires a Cisco switch with FEC capability.

#### *1.2 Before You Get Started*

Before you can configure the PRO/100 S adapter for Adapter Teaming, you need to do the following:

- Install at least two PRO/100+ or PRO/100 S server adapters in a Windows NT 4.0 or Windows 2000 system. When installation is complete make sure you restart Windows.  
**Note:** Windows NT 4.0 Service Pack 5 or later is required for implementing Adapter Teaming properly. Install Service Pack prior to configuring Adapter Teaming.
- If connecting to a hub, each adapter in a team must be connected to a port which is in the same collision domain. If connected to a switch, each adapter in a team must be connected to a port which is in the same network.

## 2. Adapter Fault Tolerance (AFT)

### 2.1 Overview

A method of safeguarding the network link to the server switch or network service using transparent backup links. Adapter Fault Tolerance (AFT) requires two adapters and an intelligent software agent that continuously monitors both links. If any component of one link fails, the redundant link takes over within seconds—typically, without users (connected via a hub or switch) even noticing the exchange.

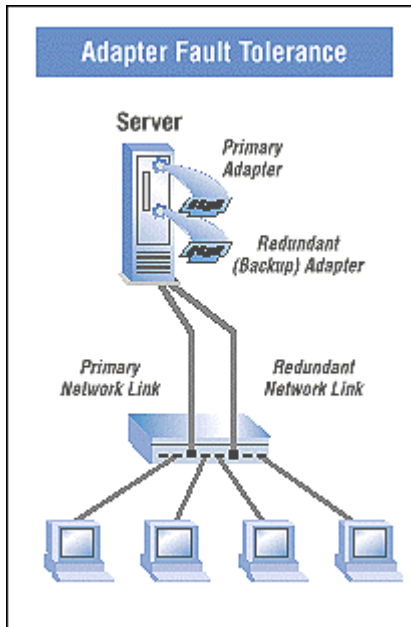

### 2.2 Performance

To increase server availability, the server communicates with the LAN via a primary adapter. If the primary link fails, traffic is automatically re-routed to the secondary adapter with no interruption of service.

### 2.3 Manageability

Generates alert when an adapter fails. This allows any problems with links to be fixed promptly. These alerts are operating system-based for compatibility with management applications such as Intel® LANDesk® Server Manager which can detect the alert and trigger an action (email, page, call).

## 3. Adaptive Load Balancing (ALB)

### 3.1 Overview

Also known as asymmetric port aggregation—is a method of ensuring consistent high server throughput and transparent backup connections by using multiple network interface cards and balancing the data transmissions across them. As many as four Intel® server adapters, connected to a switch, can be configured to work together as a "team" for an aggregate throughput of up to 400Mbps with Fast Ethernet adapters or 8Gbps with Gigabit Ethernet Adapters.

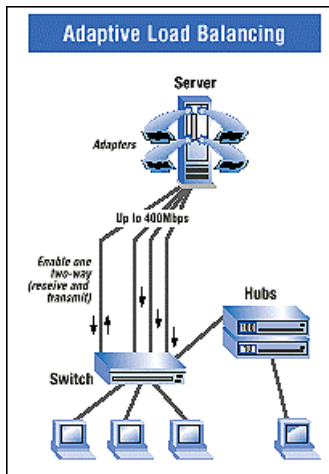

### 3.2 Performance

In ALB, an intelligent adaptive agent, provided in the driver, dynamically manages the server adapter team and evenly distributes the load among them by constantly analyzing the traffic flow from the server. In addition, four Fast Ethernet server adapters teamed with a switch can be configured for up to 400 Mbps bandwidth, or 8Gbps with Gigabit Ethernet adapters.

### 3.3 Manageability

A single network address is assigned to the collection of adapters that constitute the ALB. Aggregation team so that you no longer have to spend time segmenting the network to reduce server bottlenecks.

## 4. General Instructions

### 4.1 Perform Teaming In Windows NT4.0 Or Windows 2000

1. Setup Intel PROSet II. Then, double-click on the Intel (R) PROSet II icon in the Control Panel will launch the PROSet utility.

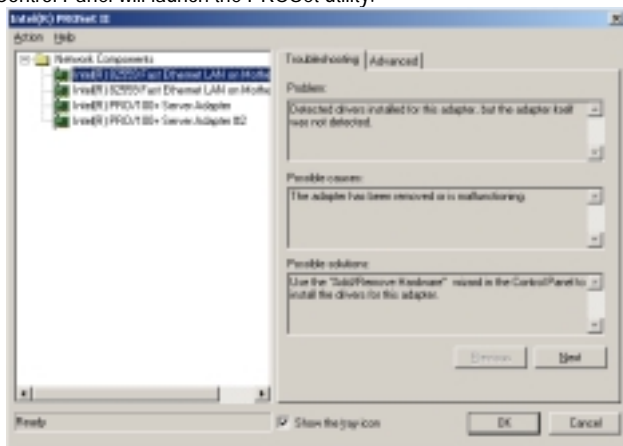

2. Create a new team .

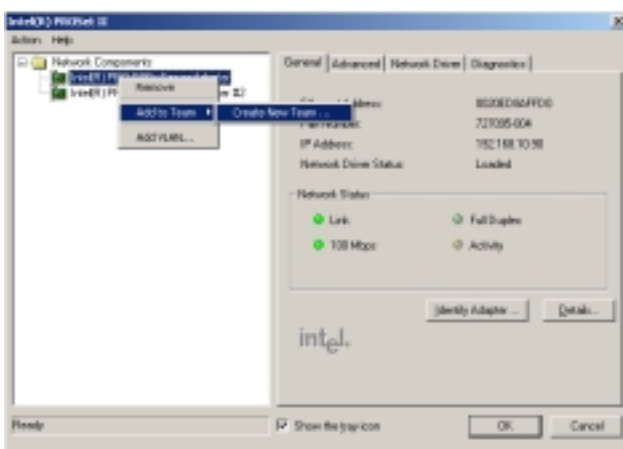

3. At the Teaming Wizard dialog, select the type of team you want to create and click Next.

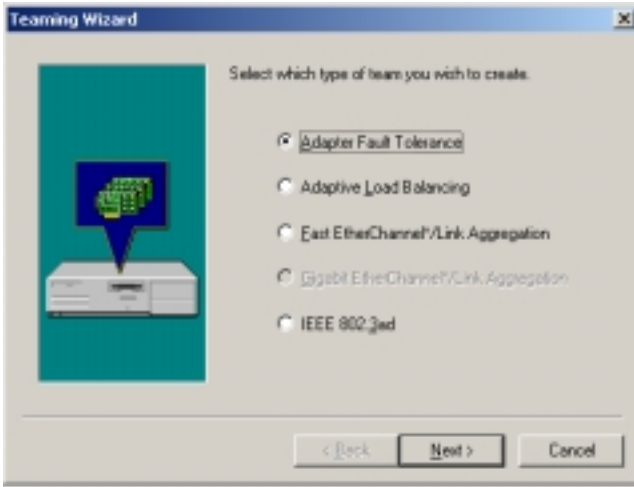

4. Add a check in the checkbox for each adapter you want as a part of the team and click Next.

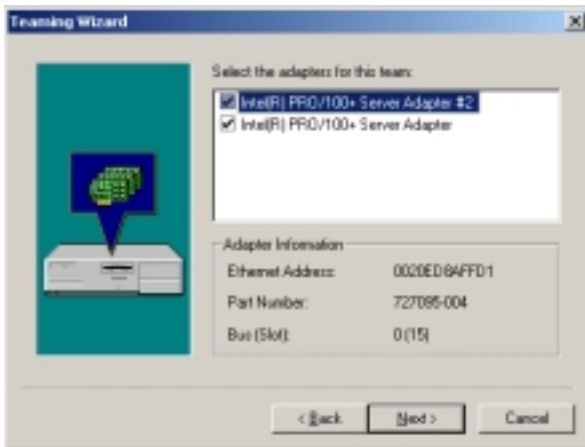

5. Click OK to close PROSet. II

You should notice a new listing in the Network control panel, which is the team you have created.

6. After the team created, a Intel® Advanced Network Services Virtual Adapter will appear on Network in the Control Panel. Assign a IP for this Virtual Adapter.

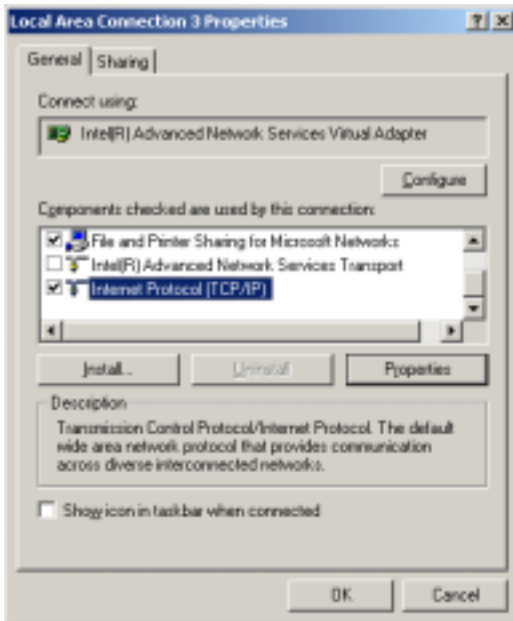



## Memory Installation

The motherboard has 4 dual inline memory module (DIMM) sockets. The BIOS will automatically detects memory type and size. To install the memory module, just push it vertically into the DIMM Slot .The DIMM module can only fit in one direction due to the two notch. Memory size can vary between sockets.

Install memory in any combination table:

DIMM	168-pin SDRAM DIMM Modules	
DIMM 1	Supports 16 / 32 / 64 / 128 / 256 / 512 MB / 1GHz	X 1 pcs
DIMM 2	Supports 16 / 32 / 64 / 128 / 256 / 512 MB / 1GHz	X 1 pcs
DIMM 3	Supports 16 / 32 / 64 / 128 / 256 / 512 MB / 1GHz	X 1 pcs
DIMM 4	Supports 16 / 32 / 64 / 128 / 256 / 512 MB / 1GHz	X 1 pcs

★Total System Memory (Max 4GB)

## DIMM QVL List

Vender	Type	Size	P/N	Chips vender	Chip P/N	Resule
TwinMOS	PC133 ECC	16Mx8 256MB	039MDS102300028	TwinMOS	TMS3808B4E-6	Pass
SMART	PC133 ECC	16Mx4 128MB	SM572164574E63R	Infineon	HYB39S64400CT	Pass
SMART	PC133 ECC	32Mx4 256MB	SM572324574E03R	SAMSUNG	K4S280432B-C75	Pass
SMART	PC133 ECC	64Mx4 512MB	SM572644578E63R	SAMSUNG	K4S560432A-TC75	Pass
SMART	PC133 ECC	1024MB	SM572284578E83R	IBM		Pass
Buffalo	PC133 ECC	16Mx8 128MB	XEX8RWG-AA	TOSHIBA	TC59SM708FT-75	Pass
ATP	PC133 ECC	16Mx4 128MB	AR16V72C4S4GAS	SAMSUNG	K4S640432D-TC75	Pass
ATP	PC133 ECC	32Mx4 256MB	AR32V72C4S4GAS	SAMSUNG	K4S280432B-TC75	Pass
ATP	PC133 ECC	64Mx4 512MB	AR64V72C4S8GAS	SAMSUNG	K4S560432A-TC75	Pass
ATP	PC133 ECC	64Mx4 1024MB	AR128V72C4SSGAS	SAMSUNG	K4S560432A-TC75	Pass
Micron	PC133 ECC	32Mx4 256MB	MT18LSDT3272G-133B1	Micron	MT48LC32M4A2-75	Pass
Micron	PC133 ECC	16Mx4 128MB	MT18LSDT1672G-133C2	Micron	MT48LC16M4A2-75	Pass
NEC	PC133 ECC	32Mx4 256MB	MC-4532DA727EF-A75	NEC	D45128441G5-A75-9JF	Pass
HITACHI	PC133 ECC	64Mx4 512MB	HB52F649E1-75B	HITACHI	5225405BTT75	Pass
APACER	PC133ECC	128MB		Infineon	HYB39S6480CT	Pass
APACER	PC133ECC	128MB	2001112-00002	Infineon	HYB39S128800CT-7.5	Pass
APACER	PC133ECC	256MB	2001121-00127	Infineon	HYB39S128400CT-7.5	Pass
APACER	PC133ECC	512MB	2000504-00026	SAMSUNG	K4S560432A-TC75	Pass

## 6EXDR Motherboard

---

 Page Index for BIOS Setup	Page
Main	P.37
Advanced	P.39
Chipset	P.49
PCIPnP	P.50
Power	P.52
Boot	P.53
Security	P.54
Exit	P.59

## BIOS Setup

BIOS Setup is an overview of the BIOS Setup Program. The program that allows users to modify the basic system configuration. This type of information is stored in battery-backed CMOS RAM so that it retains the Setup information when the power is turned off.

### ENTERING SETUP

Power ON the computer and press <Del> immediately will allow you to enter Setup. If the message disappears before you respond and you still wish to enter Setup, restart the system to try again by turning it OFF then ON or pressing the "RESET" bottom on the system case. You may also restart by simultaneously press <Ctrl> – <Alt>– <Del> keys.

### CONTROL KEYS

<↑>	Move to previous item
<↓>	Move to next item
<←>	Move to the item in the left hand
<→>	Move to the item in the right hand
<Esc>	Main Menu - Quit and not save changes into CMOS Status Page Setup Menu and Option Page Setup Menu - Exit current page and return to Main Menu
<+/PgUp>	Increase the numeric value or make changes
<-/PgDn>	Decrease the numeric value or make changes
<F1>	General help, only for Status Page Setup Menu and Option Page Setup Menu
<F2>	Reserved
<F3>	Reserved
<F4>	Reserved
<F5>	Reserved
<F6>	Reserved
<F7>	Discard Changes
<F8>	Load Failsafe Defaults
<F9>	Load Optional Defaults
<F10>	Save all the CMOS changes, only for Main Menu

## GETTING HELP

### Main Menu

The on-line description of the highlighted setup function is displayed at the bottom of the screen.

### Status Page Setup Menu / Option Page Setup Menu

Press F1 to pop up a small help window that describes the appropriate keys to use and the possible selections for the highlighted item. To exit the Help Window press <Esc>.

### Main

Once you enter AMI BIOS CMOS Setup Utility, the Main Menu (Figure 1) will appear on the screen. The Main Menu allows you to select from eight setup functions and one exit choices. Use arrow keys to select among the items and press <Enter> to accept or enter the sub-screen.

BIOS SETUP UTILITY							
Main	Advanced	Chipset	PCIPnP	Power	Boot	Security	Exit
AMIBIOS Version	:		07.00.xx				
BIOS Build Date	:		02/07/01				
BIOS ID	:		GA6EXDR0				
	:						
Processor Type	:		PentiumIII™				
Processor Speed	:		800MHz				
	:						
System Memory	:		512MB				
System Time			[14:23:47]				
System Date			[Mon 02/19/2001]				
					← →	Select Screen	
					↑ ↓	Select Item	
					+ -	Change Field	
					Tab	Select Field	
					F1	General Help	
					F10	Save and Exit	
					ESC	Exit	
V02.04 (C) Copyright 1985-2000, American Megatrends Inc.							

Figure 1: Main

- **Main**

This setup page includes all the items in standard compatible BIOS.

- **Advanced**

This setup page includes all the items of AMI special enhanced features.

(ex: Auto detect fan and temperature status, automatically configure hard disk parameters.)

- **Chipset**

This setup page includes all the items of chipset special features.

- **PCIPnP**

This setup page includes all the configurations of PCI & PnP ISA resources.

- **Power**

This setup page includes all the items of Green function features.

- **Boot**

This setup page includes all the items of first boot function features.

- **Security**

Change, set, or disable password. It allows you to limit access to the system and Setup, or just to Setup.

- **Exit**

Save CMOS value settings to CMOS and exit setup or abandon all CMOS value changes and exit setup.

- **System Time & Date**

The times format in <hour> <minute> <second>. The time is calculated base on the 24-hour military-time clock. For example, 1 p.m. is 13:00:00.

The date format is <Week> <Month> <Day>, <Year>.

Week	The week, from Sun to Sat, determined by the BIOS and is display-only
Month	The month, Jan. Through Dec.
Day	The day, from 1 to 31 (or the maximum allowed in the month)
Year	The year, from 1990 through 2099

## Advanced

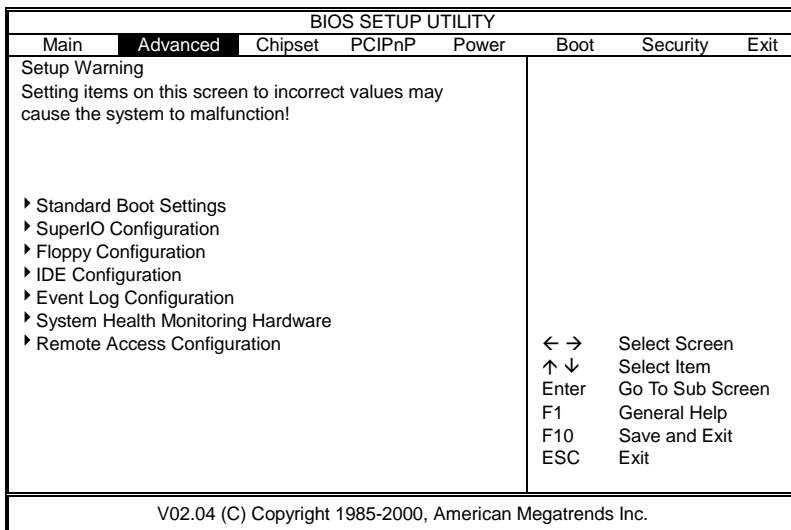

Figure 2: Advanced

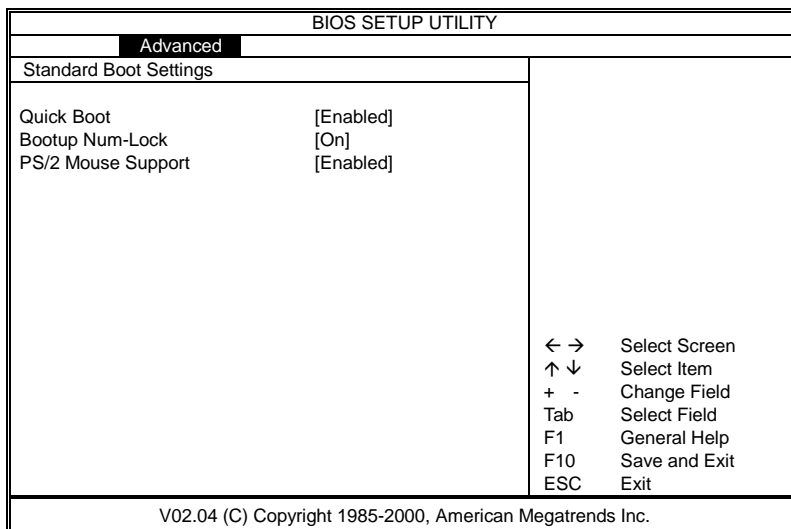

Figure 2-1: Advanced

● **Quick Boot**

Disabled	Disabled Quick Boot Function.
Enabled	Enabled Quick Boot Function. <b>(Default Value)</b>

● **Boot Up Num-Lock**

On	Keypad is number keys. <b>(Default Value)</b>
Off	Keypad is arrow keys.

● **PS/2 Mouse Support**

Enabled	Enabled PS/2 Mouse Support. <b>(Default Value)</b>
Disabled	Disabled PS/2 Mouse Support.

SuperIO Chipset Nat317	
<b>Advanced</b>	
Configure Nat317 Serial Port(s) and Parallel Port	
Serial Port1 Address	[3F8]
Serial Port1 Irq	[4]
Serial Port2 Address	[2F8]
Serial Port2 Irq	[3]
Parallel Port Address	[378]
Parallel Port IRQ	[7]
Parallel Port Mode	[ECP]
ECP Mode DMA Channel	[3]
	← → Select Screen ↑ ↓ Select Item + - Change Field Tab Select Field F1 General Help F10 Save and Exit ESC Exit
V02.04 (C) Copyright 1985-2000, American Megatrends Inc.	

Figure 2-2: Advanced

- **Serial Port 1 Address**

3F8	Enable onBoard Serial port 1 and address is 3F8. <b>(Default Value)</b>
2F8	Enable onboard Serial port 1 and address is 2F8.
3E8	Enable nboard Serial port 1 and address is 3E8.
2E8	Enable nboard Serial port 1 and address is 2E8.
Disabled	Disable nboard Serial port 1.

- **Serial Port 1 Irq**

Disabled	Disabled Serial Port1 Irq.
3	Set Serial Port1 Irq is 3.
4	Set Serial Port1 Irq is 4. <b>(Default Value)</b>

- **Serial Port 2 Address**

2F8	Enable onboard Serial port 2 and address is 2F8. <b>(Default Value)</b>
3F8	Enable onboard Serial port 2 and address is 3F8.
3E8	Enable onBoard Serial port 2 and address is 3E8.
2E8	Enable onBoard Serial port 2 and address is 2E8.
Disabled	Disable onBoard Serial port 2.

- **Serial Port 2 Irq**

Disabled	Disabled Serial Port1 Irq.
3	Set Serial Port1 Irq is 3. <b>(Default Value)</b>
4	Set Serial Port1 Irq is 4.

- **Parallel Port Address**

378	Enable On Board LPT port and address is 378. <b>(Default Value)</b>
278	Enable On Board LPT port and address is 278.
3BC	Enable On Board LPT port and address is 3BC.
Disabled	Disable On Board LPT port.

- **Parallel Port IRQ**

7	Set Parallel Port IRQ is 7. <b>(Default Value)</b>
5	Set Parallel Port IRQ is 5.



● **Parallel Port Mode**

EPP	Using Parallel port as Enhanced Parallel Port.
ECP	Using Parallel port as Extended Capabilities Port. <b>(Default Value)</b>
Normal	Normal Operation.
Bi-Directional	Using Parallel port as Bi-Directional.

● **ECP Mode DMA Channel**

3	Set Parallel Port DMA is 3. <b>(Default Value)</b>
0	Set Parallel Port DMA is 0.
1	Set Parallel Port DMA is 1.
2	Set Parallel Port DMA is 2.

BIOS SETUP UTILITY	
<b>Advanced</b>	
Floppy Configuration	
OnBoard Floppy Controller	[Enabled]
Floppy A	[1.44 MB 3½"]
Floppy B	[Disabled]
Diskette Write Protect	[Disabled]
	< → Select Screen ↑ ↓ Select Item + - Change Field Tab Select Field F1 General Help F10 Save and Exit ESC Exit
V02.04 (C) Copyright 1985-2000, American Megatrends Inc.	

Figure 2-3: Advanced

● **OnBoard Floppy Controller**

Enabled	Enabled OnBoard Floppy Controller. <b>(Default Value)</b>
Disabled	Disabled OnBoard Floppy Controller.

- **Floppy Drive A / Floppy Drive B**

The category identifies the types of floppy disk drive A or drive B that has been installed in the computer.

Disabled	No floppy drive installed
360KB, 5¼"	5¼" PC-type standard drive; 360K byte capacity.
1.2MB, 5¼"	5¼" AT-type high-density drive; 1.2M byte capacity (3½" when 3 Mode is Enabled).
720KB, 3½"	3½" double-sided drive; 720K byte capacity
1.44MB, 3½"	3½" double-sided drive; 1.44M byte capacity.
2.88MB, 3½"	3½" double-sided drive; 2.88M byte capacity.

- **Diskette Write Protect**

Enabled	Diskette Write Protect.
Disabled	Disabled Diskette Write Protect. <b>(Default Value)</b>

BIOS SETUP UTILITY	
Advanced	
IDE Configuration	
OnBoard PCI IDE Controller	[Enable]
▶ Primary IDE Master	[Not Detected]
▶ Primary IDE Slave	[Not Detected]
▶ Secondary IDE Master	[Not Detected]
▶ Secondary IDE Slave	[Not Detected]
Hard Disk Write Protect	[Disabled]
	← → Select Screen ↑ ↓ Select Item Enter Go To Sub Screen F1 General Help F10 Save and Exit ESC Exit
V02.04 (C) Copyright 1985-2000, American Megatrends Inc.	

Figure 2-4: Advanced

BIOS SETUP UTILITY	
Advanced	
Primary IDE Master (Primary IDE Slave, Secondary IDE Master, Secondary IDE Slave)	
Device:	Not Detected
Type	[Auto]
LBA/Large Mode	[Auto]
Block(Multi-Sector Transfer)	[Auto]
PIO Mode	[Auto]
DMA Mode	[Auto]
S.M.A.R.T.	[Auto]
32 Bit Data Transfer	[Enabled]
	← → Select Screen ↑ ↓ Select Item + - Change Field Tab Select Field F1 General Help F10 Save and Exit ESC Exit
V02.04 (C) Copyright 1985-2000, American Megatrends Inc.	

Figure 2-4-1: Advanced

● **OnBoard PCI IDE Controller**

Disabled	Disabled OnBoard PCI IDE Controller.
Enabled	Enabled OnBoard PCI IDE Controller. <b>(Default Value)</b>

● **Type (Primary IDE Master, Slave / Secondary IDE Master, Slave)**

Not Installed	Not Installed Primary / Secondary IDE Master, Slave type.
Auto	Auto detect Primary / Secondary IDE Master, Slave type.
CDROM	Set type is CDROM.
ARMD	Set type is ARMD.

**LBA/Large Mode**

Disabled	Disabled LBA/Large Mode.
Auto	Auto Set LBA/Large Mode.

**Block (Multi-Sector Transfer)**

Disabled	Disabled Multi-Sector Transfer.
Auto	Auto set block.

**PIO Mode**

Auto	Set PIO Mode to Auto.
0	Set PIO Mode to 0.
1	Set PIO Mode to 1.
2	Set PIO Mode to 2.
3	Set PIO Mode to 3.
4	Set PIO Mode to 4.

**DMA Mode**

Auto	Set DMA Mode to Auto.
SWDMA 0-2	Set DMA Mode to SWDMA 0-2.
MWDMA 0-2	Set DMA Mode to MWDMA 0-2.
UDMA 0-4	Set DMA Mode to UDMA0-4.

**S.M.A.R.T.**

Disabled	Enabled S.M.A.R.T. for Hard Disks.
Enabled	Disabled S.M.A.R.T. for Hard Disks. <b>(Default Value)</b>
Auto	Set Auto for S.M.A.R.T. for Hard Disks.

**32 Bit Data Transfer**

Enabled	Enabled 32Bit Data Transfer. <b>(Default Value)</b>
Disabled	Disabled 32Bit Data Transfer.

- **Hard Disk Write Protect**

Disabled	Disabled Hard Disk Write Protect. <b>(Default Value)</b>
Enabled	Hard Disk Write Protect.

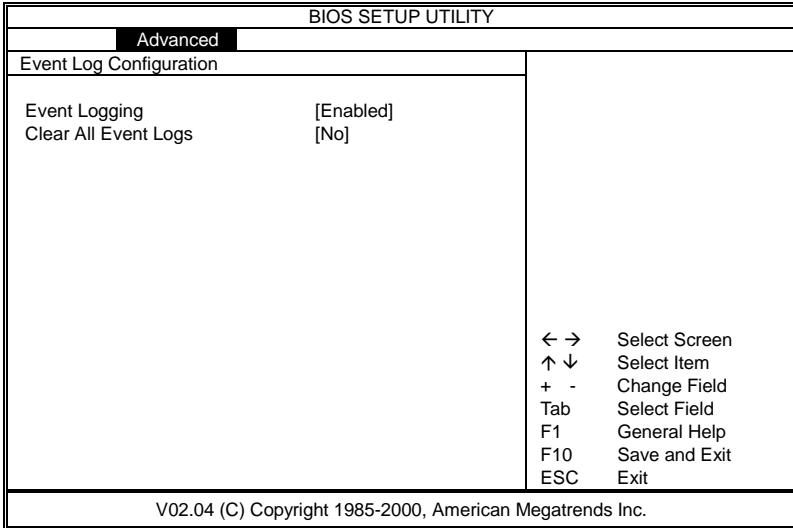

Figure 2-5: Advanced

- **Event Logging**

Disabled	Disabled Event Logging. <b>(Default Value)</b>
Enabled	Enabled Event Logging.

- **Clear All Event Logs**

Yes	Enabled Clear All Event Logs. <b>(Default Value)</b>
No	Disabled Clear All Event Logs.

BIOS SETUP UTILITY		
Advanced		
<b>System Health Monitoring</b>		
ACPI Shut Down Temp.	[Disabled]	
CPU Temp. Alarm	[Disabled]	
CPU1 Fan Fail Alarm	[No]	
CPU2 Fan Fail Alarm	[No]	
Power Fan1 Fail Alarm	[No]	
Power Fan2 Fail Alarm	[No]	
System Fan Fail Alarm	[No]	
Reset Case Open Status	[No]	
Case Status	[Closed]	
CPU1 Present	[OK!]	
CPU2 Present	[FAIL!]	
Current CPU1 Temp.	53°C/127°F	
Current CPU2 Temp.	127°C/260°F	
Current CPU1 Fan Speed	5113 MPR	
Current CPU2 Fan Speed	0 MPR	
Current System Fan Speed	0 MPR	
CPU VID	1.50V	
Vcc2P	1.595V °F	← → Select Screen
Vcc2S	1.308V °F	↑ ↓ Select Item
Vcc 3	2.759V °F	+ - Change Field
Vcc	4.933V °F	Tab Select Field
+12V	12.075V °F	F1 General Help
5V SB	4.775V °F	F10 Save and Exit
VBAT	2.408V °F	ESC Exit
V02.04 (C) Copyright 1985-2000, American Megatrends Inc.		

Figure 2-6: Advanced

- **ACPI Shut Down Temp. (°C / °F)**

(This function will be effective only for the operating systems that support ACPI Function.)

Disabled	Disabled ACPI Shutdown function. <b>(Default Value)</b>
60°C / 140°F	Monitor CPU Temp. at 60°C / 140°F, if Temp. > 60°C / 140°F system will automatically power off.
70°C / 158°F	Monitor CPU Temp. at 70°C / 158°F, if Temp. > 70°C / 158°F system will automatically power off.
80°C / 176°F	Monitor CPU Temp. at 80°C / 176°F, if Temp. > 80°C / 176°F system will automatically power off.
90°C / 194°F	Monitor CPU Temp. at 90°C / 194°F, if Temp. > 90°C / 194°F system will automatically power off.

- **CPU Temp. Alarm**

Disabled	Normal Operation. <b>(Default value)</b>
60°C / 140°F	Monitor CPU Warning Temp. at 60°C / 140°F
70°C / 158°F	Monitor CPU Warning Temp. at 70°C / 158°F
80°C / 176°F	Monitor CPU Warning Temp. at 80°C / 176°F
90°C / 194°F	Monitor CPU Warning Temp. at 90°C / 194°F

- **Fan Fail Alarm**

CPU 1 / CPU 2 / System / Power Fan 1 / Power Fan 2

No	Fan Fail Alarm Function Disabled. <b>(Default value)</b>
Yes	Fan Fail Alarm Function Enabled.

- **Reset Case Open Status**

- **Case Status**

If the case is closed, "Case Status" will show "Closed".

If the case have been opened, "Case Status" will show "Closed".

If you want to reset "Case Status" value, set "Reset Case Open Status" to "Yes" and save CMOS, your computer will restart.

- **CPU 1 / CPU 2 Present.**

Detect CPU1 / CPU 2 Status automatically.

- **Current CPU1 / CPU2 Temp. (°C / °F)**

Detect CPU 1 / CPU 2 / Temperature automatically.

- **Current CPU1 / CPU2 / System Fan Speed**

Detect CPU 1 / CPU 2 / System Fan speed status automatically.

- **Current Voltage (V)**

**CPU VID / Vcc2P / Vcc2S / Vcc3 / Vcc / 5V SB / VBAT / +12 V**

Detect system's voltage status automatically.

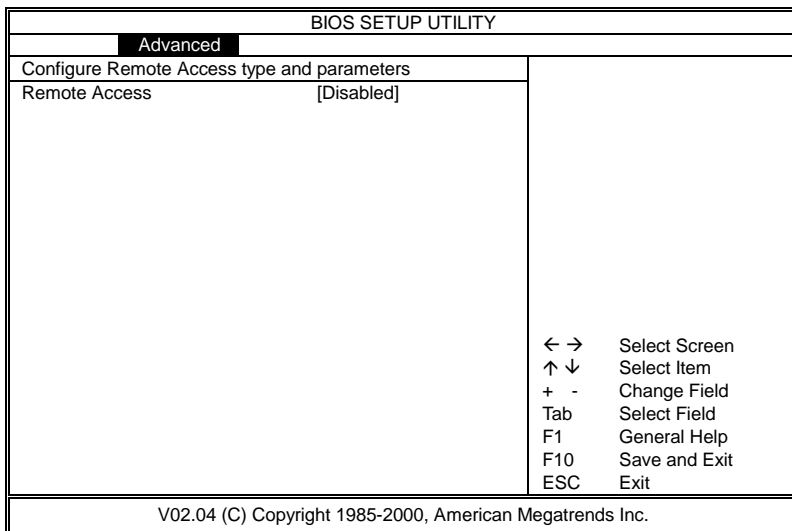

Figure 2-7: Advanced

- **Remote Access**

Disabled	Disable this Function. <b>(Default Value)</b>
Serial (ANSI)	Server use COM port to control client.



## Chipset

BIOS SETUP UTILITY							
Main	Advanced	Chipset	PCIPnP	Power	Boot	Security	Exit
Memory Scrubbing		[Disabled]					
ISA IO Cycle Delay		[1.5 BCLK]					
MPS 1.4 Support		[Enabled]					
						← →	Select Screen
						↑ ↓	Select Item
						+ -	Change Field
						Tab	Select Field
						F1	General Help
						F10	Save and Exit
						ESC	Exit
V02.04 (C) Copyright 1985-2000, American Megatrends Inc.							

Figure 3: Chipset

- **Memory Scrubbing**

Disabled	Disabled Memory scrubbing. <b>(Default Value)</b>
Enabled	Enabled Memory scrubbing writes the ECC corrected memory data back to the DRAM.

- **ISA IO Cycle Delay** (Define the delay inserted between an ISA I/O cycle and the next cycle)

Full Delay	Set ISA IO cycle delay is full delay.
1.5 BCLK	Set ISA IO cycle delay is 1.5 BCLK. <b>(Default Value)</b>
2.5 BCLK	Set ISA IO cycle delay is 2.5 BCLK.
3.5 BCLK	Set ISA IO cycle delay is 3.5 BCLK.

- **MPS 1.4 Support** (Support Multi Processor Specification revision 1.4)

Enabled	Enabled MPS 1.4 support. <b>(Default Value)</b>
Disabled	Disabled MPS 1.4 support.

## PCIPnP

BIOS SETUP UTILITY							
Main	Advanced	Chipset	PCIPnP	Power	Boot	Security	Exit
Plug & Play O/S		[No]					
Reset Config Data		[No]					
PCI Latency Timer		[64]					
Palette Snooping		[Disabled]					
USB Function		[Enabled]					
Legacy USB Support		[Auto]					
				← → Select Screen ↑ ↓ Select Item + - Change Field Tab Select Field F1 General Help F10 Save and Exit ESC Exit			
V02.04 (C) Copyright 1985-2000, American Megatrends Inc.							

Figure 4: PCIPnP

- **Plug & Play O/S**

Yes	Enable Plug and Play Aware O/S function.
No	Disable Plug and Play Aware O/S function <b>(Default Value)</b>

- **Reset Config Data**

Yes	Clear PnP information in ESCD & update DMI data.
No	Disabled this function. <b>(Default Value)</b>

- **PCI Latency Timer**

32	Set PCI Latency Timer is 32.
64	Set PCI Latency Timer is 64. <b>(Default Value)</b>
96	Set PCI Latency Timer is 96.
128	Set PCI Latency Timer is 128.
160	Set PCI Latency Timer is 160.
192	Set PCI Latency Timer is 192.
224	Set PCI Latency Timer is 224.
248	Set PCI Latency Timer is 248.

- **Palette Snoop**

Enabled	For having Video Card on ISA Bus and VGA Card on PCI Bus.
Disabled	For VGA Card only. <b>(Default Value)</b>

- **USB Function**

Enabled	USB Controller for All USB Port. <b>(Default Value)</b>
Disabled	USB Controller Function Disabled.

- **Legacy USB Support**

Enabled	Enabled USB Legacy Support Keyboard.
Disabled	Disabled USB Legacy Support Keyboard.
Auto	Set Auto USB Legacy Support Function. <b>(Default Value)</b>

## Power

BIOS SETUP UTILITY							
Main	Advanced	Chipset	PCIPnP	Power	Boot	Security	Exit
ACPI Aware O/S		[Yes]					
Power Management		[Disabled]					
System After AC Back		[Off]					
				← → Select Screen ↑ ↓ Select Item + - Change Field Tab Select Field F1 General Help F10 Save and Exit ESC Exit			
V02.04 (C) Copyright 1985-2000, American Megatrends Inc.							

Figure 5: Power

- **ACPI Aware O/S**

Yes	Enabled ACPI Aware O/S. <b>(Default Value)</b>
No	Disabled ACPI Aware O/S.

- **Power Management**

Enabled	Enable Green function.
Disabled	Disable Green function. <b>(Default Value)</b>

- **System After AC Back**

Off	Set Restore on AC/Power Loss is Power off. <b>(Default Value)</b>
Last State	Set Restore on AC/Power Loss is Last state mode.

## Boot

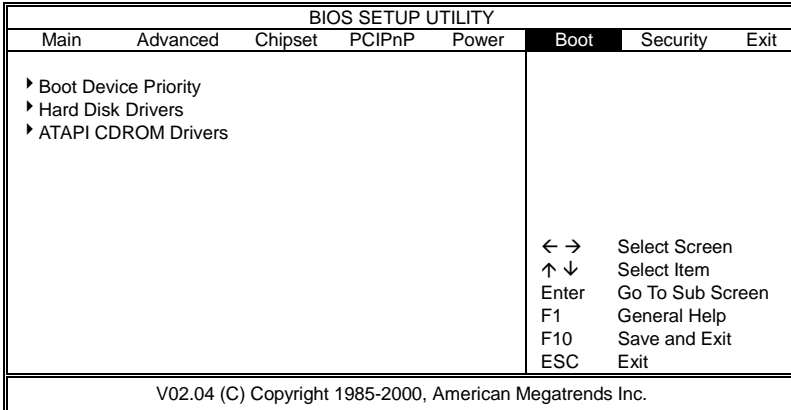

Figure 6: Boot

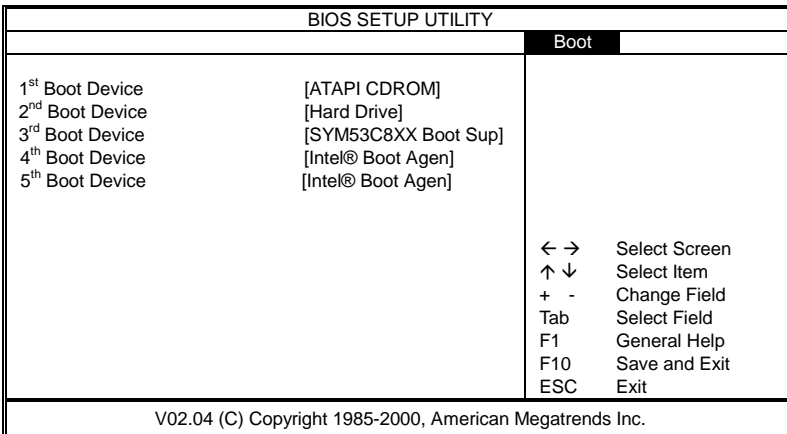

Figure 6-1: Boot

**Figure 6:** It will list all the bootable devices found by BIOS.

**Figure 6-1:** Lets the user to set the boot device priority.

## Security

BIOS SETUP UTILITY							
Main	Advanced	Chipset	PCIPnP	Power	Boot	Security	Exit
Supervisor Password :		Not Installed					
User Password :		Not Installed					
▶ Change Supervisor Password							
▶ Change User Password							
▶ Clear User Password							
Boot Sector Virus Protection		[Disabled]					
		← → Select Screen ↑ ↓ Select Item Enter Go to Sub Screen F1 General Help F10 Save and Exit ESC Exit					
V02.04 (C) Copyright 1985-2000, American Megatrends Inc.							

Figure 7: Security

The BIOS Setup program allows you to specify two separate passwords: a **SUPERVISOR PASSWORD** and a **USER PASSWORD**. When disabled, anyone may access all BIOS Setup program function. When enabled, the Supervisor password is required for entering the BIOS Setup program and having full configuration fields, the User password is required to access only basic items.

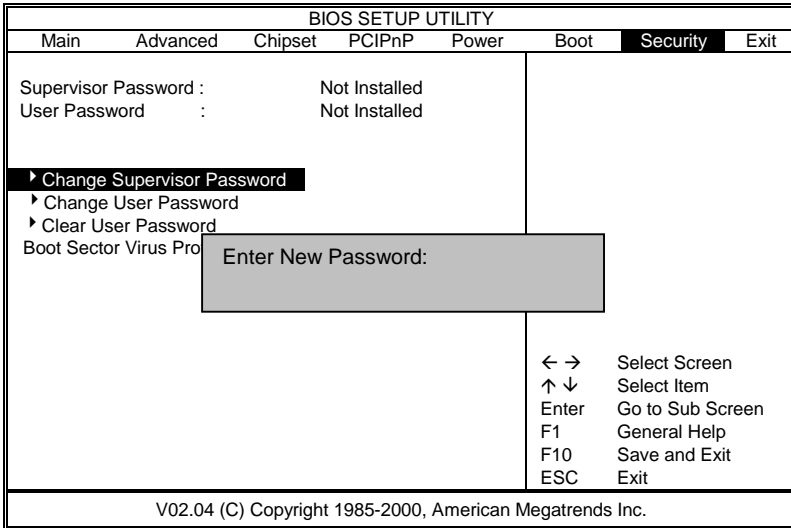

Figure 7-1: Security

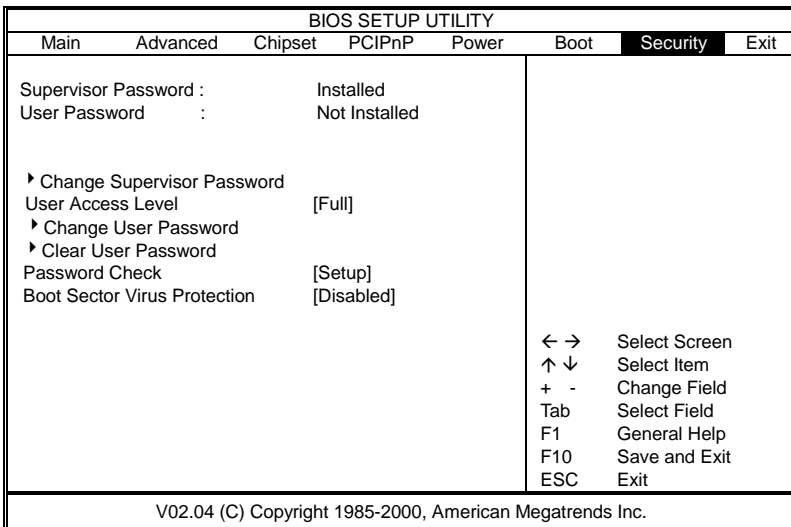

Figure 7-2: Security

---

## 6EXDR Motherboard

---

When you select **"Change Supervisor Password"** this function, the following message will appear at the center of the screen to assist you in creating a password.

Type the password, up to six characters, and press <Enter>. You will be asked to confirm the password. Type the password again and press <Enter>. You may also press <Esc> to abort the selection and not enter a password.

To disable password, enter your password and then press <Enter> when prompts you for "Enter New Password". A message **"Password Uninstalled"** will appear to confirm the password being disabled. Once the password is disabled, the system will boot and you can enter Setup freely.

- **User Access Level** (A supervisor can set the "User Access Level" for their user.)

No Access	Prevents user access to the setup utility.
View Only	Allows access to the setup utility but the fields can not be changed. <b>(Default Value)</b>
Limited	Allows only limited fields to be changed such as date and time.
Full	Allows any filed to be changed except the supervisor password.

- **Password Check**

Setup	Set Password Check to Setup. <b>(Default Value)</b>
Always	Set Password Check to Always.

If you select **"Always"** at **"Password Check"** , you will be prompted for the password every time the system is rebooted or any time you try to enter Setup Menu.

If you select **"Setup"** at **"Password Check"** , you will be prompted only when you try to enter Setup.



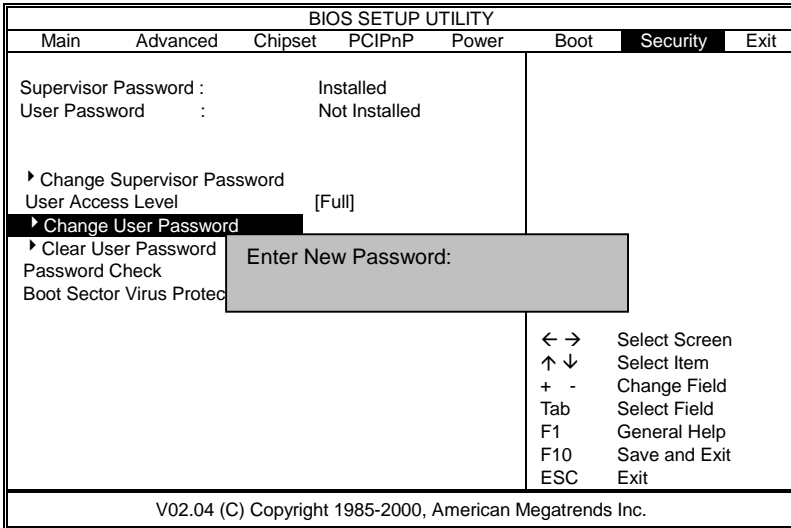

Figure 7-3: Security

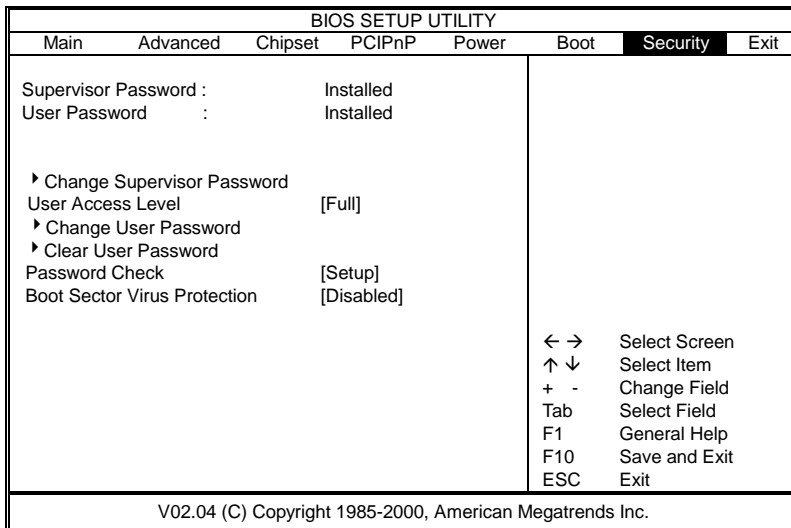

Figure 7-4: Security

When you select **"Change User Password"** this function, the following message will appear at the center of the screen to assist you in creating a password.

Type the password, up to six characters, and press <Enter>. You will be asked to confirm the password. Type the password again and press <Enter>. You may also press <Esc> to abort the selection and not enter a password.

To disable password, enter your password and then press <Enter> when prompts you for "Enter New Password". A message **"Password Uninstalled"** will appear to confirm the password being disabled. Once the password is disabled, the system will boot and you can enter Setup freely.

- **Boot Sector Virus Protection**

If it is set to enable, the category will flash on the screen when there is any attempt to write to the boot sector or partition table of the hard disk drive. The system will halt and the following error message will appear in the mean time. You can run anti-virus program to locate the problem.

Enabled	Activate automatically when the system boots up causing a warning message to appear when anything attempts to access the boot sector or hard disk partition table
Disabled	No warning message to appear when anything attempts to access the boot sector or hard disk partition table. <b>(Default Value)</b>

## Exit

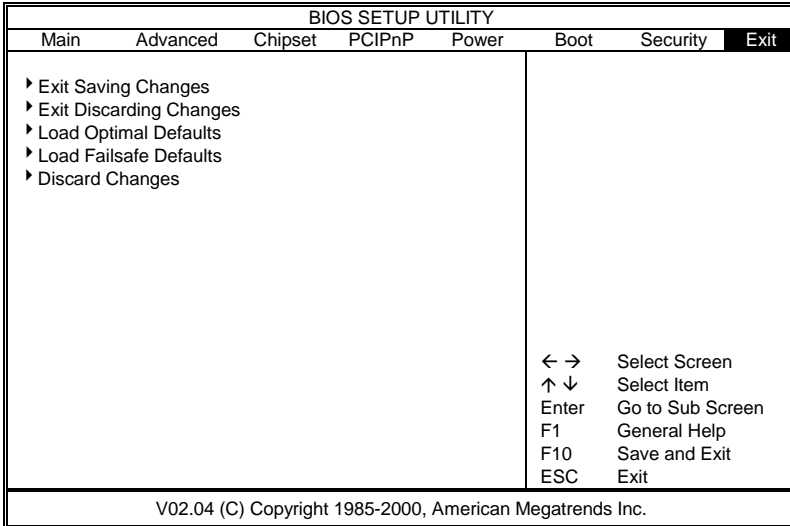

Figure 8: Exit

- **Exit Saving Changes**

Type "Y" will quit the Setup Utility and save the user setup value to RTC CMOS.

Type "N" will return to Setup Utility.

- **Exit Discarding Changes**

Type "Y" will quit the Setup Utility without saving to RTC CMOS.

Type "N" will return to Setup Utility.

- **Load Optimal Defaults**

BIOS defaults contain the most appropriate values of the system parameters that allow minimum system performance.

- **Load Failsafe Defaults**

Selecting this field loads the factory defaults for BIOS and Chipset Features which the system automatically detects.

- **Discard Changes**

To get back to the previous setting, select "Discard Changes".

# Appendix

## Appendix A : Intel 82559 LAN Driver Installation

Insert the support CD that came with your motherboard into your CD-ROM driver or double –click the CD driver icon in My Computer to bring up the screen.

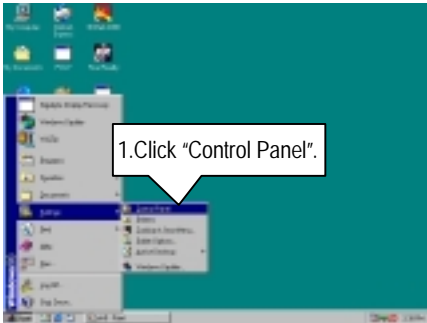

(1)

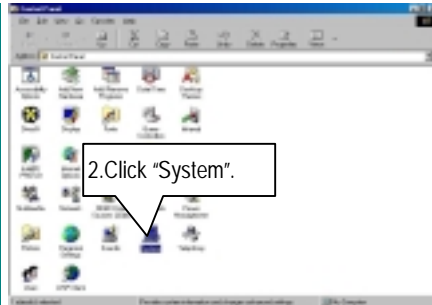

(2)

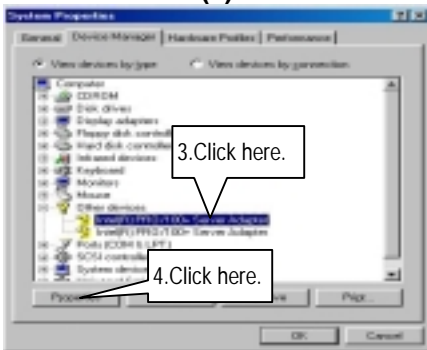

(3)

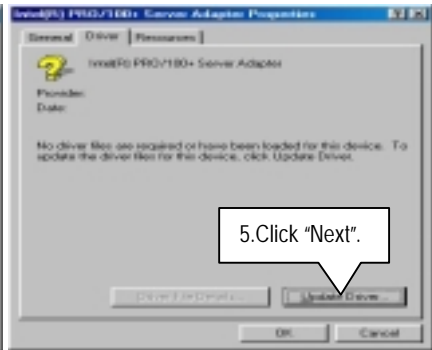

(4)



(5)

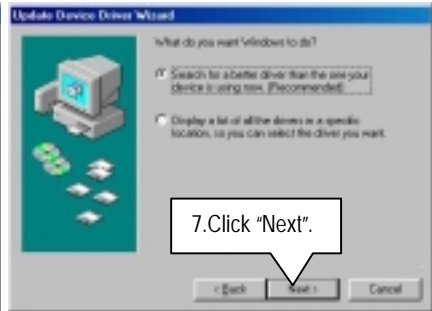

(6)

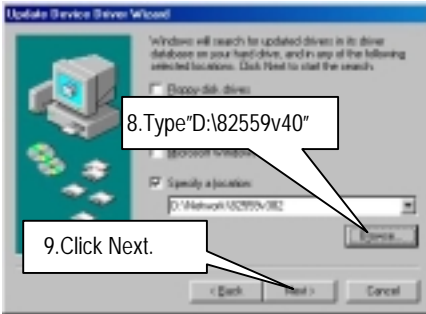

(7)

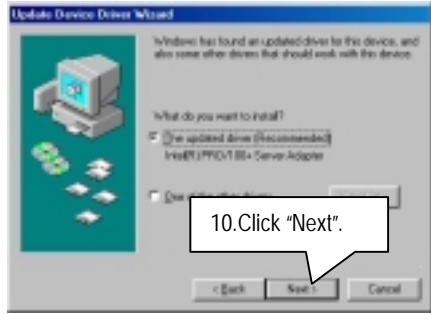

(8)



(9)

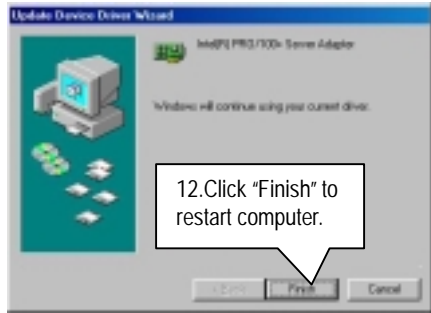

(10)

## Appendix B: BIOS Flash Procedure

BIOS update procedure:

If your OS is Win9X, we recommend that you used Gigabyte @BIOS Program to flash BIOS.

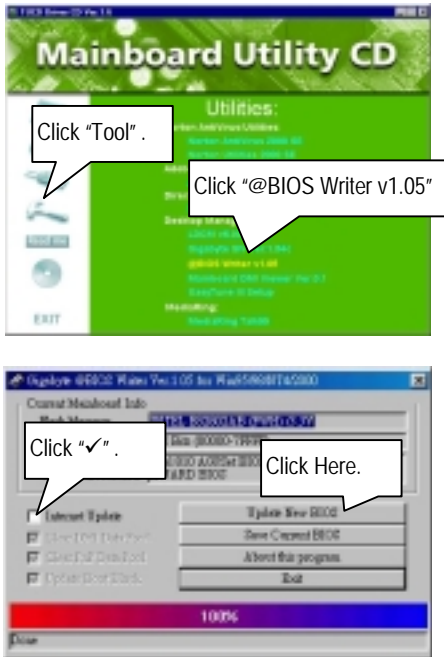

Methods and steps :

### I. Update BIOS through Internet

- a. Click "Internet Update" icon
- b. Click "Update New BIOS" icon
- c. Select @BIOS sever ("Gigabyte @BIOS sever 1 in Taiwan" and "Gigabyte @BIOS sever 2 in Taiwan" are available for now, the others will be completed soon)
- d. Select the exact model name on your motherboard
- e. System will automatically download and update the BIOS.

II. Update BIOS **NOT** through Internet :

- a. **Do not** click "Internet Update" icon
- b. Click "Update New BIOS"
- c. Please select "All Files" in dialog box while opening the old file.
- d. Please search for BIOS unzip file, downloading from internet or any other methods (such as: 6EXDR.F1).
- e. Complete update process following the instruction.

III. Save BIOS

In the very beginning, there is "Save Current BIOS" icon shown in dialog box. It means to save the current BIOS version.

IV. Check out supported motherboard and Flash ROM :

In the very beginning, there is "About this program" icon shown in dialog box. It can help you check out which kind of motherboard and which brand of Flash ROM are supported.

Note :

- a. In method I, if it shows two or more motherboard's model names to be selected, please make sure your motherboard's model name again. Selecting name will cause the system unbooted.
- b. In method II, be sure that motherboard's model name in BIOS unzip file are the same as your motherboard's. Otherwise, your system won't boot.
- c. In method I, if the BIOS file you need cannot be found in @BIOS server, please go onto Gigabyte's web site for downloading and updating it according to method II.
- d. Please note that any intercorruption during updating will cause system unbooted

## 6EXDR Motherboard

---

Or else you can select flash BIOS in DOS mode.

● Please check your **BIOS vendor (AMI or AWARD)**, your **motherboard name** and **PCB version** on the motherboard.

1. Format a bootable system floppy diskette by the command "**format a:/s**" in command mode.
2. Visit the Gigabyte website at [http:// www.gigabyte.com.tw](http://www.gigabyte.com.tw) ,Select the BIOS file you need and download it to your bootable floppy diskette.
3. Insert the bootable diskette containing the BIOS file into the floppy diskette driver.
4. Assuming that the floppy diskette driver is A, reboot the system by using the A: driver. At the A: > prompt, run the BIOS upgraded file by executing the Flash BIOS utility and the BIOS file with its appropriate extension.

Example: *(AMI tool) (Where 6EXDR.f1 is name of the BIOS file name)*

```
A:>flashxxx.exe 6EXDR.f1 ←↵
```

Example: *(Award tool) (Where 6EXDR.f1 is name of the BIOS file name)*

```
A:>wdfash.exe 6EXDR.f1 ←↵
```

5. Upon pressing the <Enter> key, a flash memory writer menu will appear on screen. Enter the new BIOS file name with its extension filename into the text box after file name to program.
6. If you want to save the old BIOS file(perform as soon as system is operational, this is recommended), select Y to **DO YOU WANT TO SAVE BIOS**, then type the old BIOS filename and the extension after filename to save: This option allows you to copy the contents of the flash memory chip onto a diskette, giving you a backup copy of the original motherboard BIOS in case you need to re-install it. Select N to **DO YOU WANT TO SAVE BIOS**, if you don't want to save the old BIOS file.
7. After the decision to save the old BIOS file or not is made, select Y to **ARE YOU SURE TO PROGRAM** when the next menu appear; wait until a message showing Power Off or Reset the system appears. Then turn off your system.
8. Remove the diskette and restart your system.
9. Hold down <Delete> key to enter BIOS setup. You must select "Load Setup BIOS Default" to activate the new BIOS, then you may set other item from the main menu.



## Appendix C: Acronyms

Acronyms	Meaning
ACPI	Advanced Configuration and Power Interface
APM	Advanced Power Management
AGP	Accelerated Graphics Port
AMR	Audio Modem Riser
ACR	Audio Communication Riser
BIOS	Basic Input / Output System
CPU	Central Processing Unit
CMOS	Complementary Metal Oxide Semiconductor
CRIMM	Continuity RIMM
CNR	Communication and Networking Riser
DMA	Direct Memory Access
DMI	Desktop Management Interface
DIMM	Dual Inline Memory Module
DRM	Dual Retention Mechanism
DRAM	Dynamic Random Access Memory
DDR	Double Data Rate
ECP	Extended Capabilities Port
ESCD	Extended System Configuration Data
ECC	Error Checking and Correcting
EMC	Electromagnetic Compatibility
EPP	Enhanced Parallel Port
ESD	Electrostatic Discharge
FDD	Floppy Disk Device
HDD	Hard Disk Device
IDE	Integrated Dual Channel Enhanced
IRQ	Interrupt Request
I/O	Input / Output
IOAPIC	Input Output Advanced Programmable Input Controller
ISA	Industry Standard Architecture
LAN	Local Area Network
LBA	Logical Block Addressing
LED	Light Emitting Diode
MHz	Megahertz
MIDI	Musical Interface Digital Interface
MTH	Memory Translator Hub
MPT	Memory Protocol Translator
NIC	Network Interface Card
OS	Operating System

To be continued...

## 6EXDR Motherboard

---

Acronyms	Meaning
OEM	Original Equipment Manufacturer
PAC	PCI A.G.P. Controller
POST	Power-On Self Test
PCI	Peripheral Component Interconnect
RIMM	Rambus in-line Memory Module
SCI	Special Circumstance Instructions
SECC	Single Edge Contact Cartridge
SRAM	Static Random Access Memory
SMP	Symmetric Multi-Processing
SMI	System Management Interrupt
USB	Universal Serial Bus
VID	Voltage ID