

FCC Compliance Statement:

<p>DECLARATION OF CONFORMITY Per FCC Part 2 Section 2.107(a)</p> <p>FC</p> <p>Responsible Party Name: G.B.T. INC.</p> <p>Address: 18365 Valley Blvd., Suite#A LA Point, CA 91744</p> <p>Phone/Fax No: (818) 854-9338/ (818) 854-9339</p> <p>hercby declart s that the roduct</p> <p>Product Name: Mother Board</p> <p>Model Number: GA 6VM1 4X</p> <p>Conforms to the following specifications:</p> <p>FCC Part 15, Subpart B, Section 15.107(a) and Section 15.109(a), Class B Digital Device.</p> <p>Supplementary Information:</p> <p>This device complies with part 15 of the FCC Rules. Operation is subject to the following two conditions: (1) This device may not cause harmful and (2) this device must accept any interference received, including that may cause undesired operation.</p> <p>Representative Person's Name: <u>ERIC LI</u></p> <p>Signature: <u>ERIC LI</u></p> <p>Date: <u>Jan 31 2000</u></p>

This equipment has been tested and found to comply with limits for a Class B digital device , pursuant to Part 15 of the FCC rules. These limits are designed to provide reasonable protection against harmful interference in residential installations. This equipment generates, uses, and can radiate radio frequency energy, and if not installed and used in accordance with the instructions, may cause harmful interference to radio communications. However, there is no guarantee that interference will not occur in a particular installation. If this equipment does cause interference to radio or television equipment reception, which can be

determined by turning the equipment off and on, the user is encouraged to try to correct the interference by one or more of the following measures:

- Reorient or relocate the receiving antenna
- Move the equipment away from the receiver
- Plug the equipment into an outlet on a circuit different from that to which the receiver is connected
- Consult the dealer or an experienced radio/television technician for additional suggestions

You are cautioned that any change or modifications to the equipment not expressly approve by the party responsible for compliance could void Your authority to operate such equipment.

This device complies with Part 15 of the FCC Rules. Operation is subjected to the following two conditions 1) this device may not cause harmful interference and 2) this device must accept any interference received, including interference that may cause undesired operation.

Declaration of Conformity

We, Manufacturer/Importer
(full address)

G.B.T. Technology Trading GmbH
Ausschlagler Weg 41, 1F, 20537 Hamburg, Germany

declare that the product
(description of the apparatus, system, installation to which it refers)

Mother Board
GA-6VM7-4X

is in conformity with
(reference to the specification under which conformity is declared)
in accordance with 89/336 EEC-EMC Directive

- | | | | |
|---|--|--|--|
| <input type="checkbox"/> EN 55011 | Limits and methods of measurement of radio disturbance characteristics of industrial, scientific and medical (ISM) high frequency equipment | <input type="checkbox"/> EN 61000-3-2*
<input checked="" type="checkbox"/> EN60555-2 | Disturbances in supply systems caused by household appliances and similar electrical equipment " Harmonics" |
| <input type="checkbox"/> EN55013 | Limits and methods of measurement of radio disturbance characteristics of broadcast receivers and associated equipment | <input type="checkbox"/> EN61000-3-3*
<input checked="" type="checkbox"/> EN60555-3 | Disturbances in supply systems caused by household appliances and similar electrical equipment " Voltage fluctuations" |
| <input type="checkbox"/> EN 55014 | Limits and methods of measurement of radio disturbance characteristics of household electrical appliances, portable tools and similar electrical apparatus | <input checked="" type="checkbox"/> EN 50081-1
<input checked="" type="checkbox"/> EN 50082-1 | Generic emission standard Part 1:
Residual, commercial and light industry

Generic immunity standard Part 1:
Residual, commercial and light industry |
| <input type="checkbox"/> EN 55015 | Limits and methods of measurement of radio disturbance characteristics of fluorescent lamps and luminaries | <input type="checkbox"/> EN 55081-2 | Generic emission standard Part 2:
Industrial environment |
| <input type="checkbox"/> EN 55020 | Immunity from radio interference of broadcast receivers and associated equipment | <input type="checkbox"/> EN 55082-2 | Generic immunity standard Part 2:
Industrial environment |
| <input checked="" type="checkbox"/> EN 55022 | Limits and methods of measurement of radio disturbance characteristics of information technology equipment | <input type="checkbox"/> ENV 55104 | Immunity requirements for household appliances tools and similar apparatus |
| <input type="checkbox"/> DIN VDE 0855
<input type="checkbox"/> part 10
<input type="checkbox"/> part 12 | Cabled distribution systems: Equipment for receiving and/or distribution from sound and television signals | <input type="checkbox"/> EN 50091- 2 | EMC requirements for uninterruptible power systems (UPS) |

CE marking



(EC conformity marking)

The manufacturer also declares the conformity of above mentioned product with the actual required safety standards in accordance with LVD 73/23 EEC

- | | | | |
|-----------------------------------|---|-------------------------------------|---|
| <input type="checkbox"/> EN 60065 | Safety requirements for mains operated electronic and related apparatus for household and similar general use | <input type="checkbox"/> EN 60950 | Safety for information technology equipment including electrical business equipment |
| <input type="checkbox"/> EN 60335 | Safety of household and similar electrical appliances | <input type="checkbox"/> EN 50091-1 | General and Safety requirements for uninterruptible power systems (UPS) |

Manufacturer/Importer

Signature : Rex Lin
Name : Rex Lin

(Stamp)

Date : Jan. 21, 2000

6VM7-4X
Socket 370 Processor Motherboard

USER'S MANUAL

Socket 370 Processor Motherboard
REV. 1.2 Second Edition
R-12-02-000425

How This Manual Is Organized

This manual is divided into the following sections:

1) Revision History	Manual revision information
2) Item Checklist	Product item list
3) Features	Product information & specification
4) Hardware Setup	Instructions on setting up the motherboard
5) Performance & Block Diagram	Product performance & block diagram
6) BIOS Setup	Instructions on setting up the BIOS software
7) Appendix	General reference

Table Of Content

Revision History	P.1
Item Checklist	P.2
Summary of Features	P.3
6VM7-4X Motherboard Layout	P.5
Page Index for CPU Speed Setup / Connectors / Panel and Jumper Definition	P.6
Performance List	P.24
Block Diagram	P.25
Memory Installation	P.26
Page Index for BIOS Setup	P.27
Appendix	P.55

Revision History

Revision	Revision Note	Date
1.2	Initial release of the 6VM7-4X motherboard user' s manual.	Mar.2000
1.2	Second release of the 6VM7-4X motherboard user' s manual.	Apr.2000

The author assumes no responsibility for any errors or omissions that may appear in this document nor does the author make a commitment to update the information contained herein.

Third-party brands and names are the property of their respective owners.

Item Checklist

- The 6VM7-4X motherboard
- Cable for IDE / floppy device
- Diskettes or CD (TUCD) for motherboard driver & utility
- Internal COMB Cable (Optional).
- Internal USB Cable (Optional).
- Cable for SCSI device
- 6VM7-4X user' s manual

Summary Of Features

Form Factor	24.3 cm x 21.0 cm Micro ATX size form factor, 4 layers PCB.
CPU	<ul style="list-style-type: none"> • Socket 370 Processor • 2nd cache in CPU(Depend on CPU)
Chipset	<ul style="list-style-type: none"> • VT82C694X (VIA Apollo Pro 133A) • VT82C686A
Clock Generator	<ul style="list-style-type: none"> • ICS 9248DF-39 • 66/100/133 MHz system bus speeds (PCI 33MHz) • 75/83/112/124/140/150 MHz system bus speeds (PCI 44MHz) (reserved)
Memory	<ul style="list-style-type: none"> • 2 168-pin DIMM sockets. • Supports PC-100 / PC-133 SDRAM and VCM SDRAM • Supports up to 1.0GB DRAM • Supports only 3.3V SDRAM DIMM • Supports 72bit ECC type DRAM integrity mode.
I/O Control	<ul style="list-style-type: none"> • VT82C686A
Slots	<ul style="list-style-type: none"> • 1 AGP Slot Supports 4X mode & AGP 2.0 compliant • 3 PCI Slot Supports 33MHz & PCI 2.2 compliant • 1 AMR(Audio Modem Riser)Slot
On-Board IDE	<ul style="list-style-type: none"> • 2 IDE bus master, DMA 33/ ATA 66 IDE ports for up to 4 ATAPI devices • Supports PIO mode 3, 4, UDMA33/ATA66 IDE & ATAPI CD-ROM
On-Board Peripherals	<ul style="list-style-type: none"> • 1 floppy port supports 2 FDD with 360K, 720K,1.2M, 1.44M and 2.88M bytes • 1 parallel ports supports SPP/EPP/ECP mode • 2 serial ports (COMA & COMB) • 2 USB ports
Hardware Monitor	<ul style="list-style-type: none"> • CPU/System fan revolution detect • CPU /System temperature detect • System voltage detect (Vcore,Vcc3,Vcc,+12V) • CPU overheat shutdown detect
PS/2 Connector	<ul style="list-style-type: none"> • PS/2[®] Keyboard interface and PS/2[®] Mouse interface

To be continued..

Summary Of Features

BIOS	<ul style="list-style-type: none">• Licensed AMI BIOS, 2M bit flash ROM
On-Board Sound	<ul style="list-style-type: none">• Creative CT5880
Additional Features	<ul style="list-style-type: none">• Includes 3 fan power connectors.• Poly fuse for keyboard over-current protection

6VM7-4X Motherboard Layout

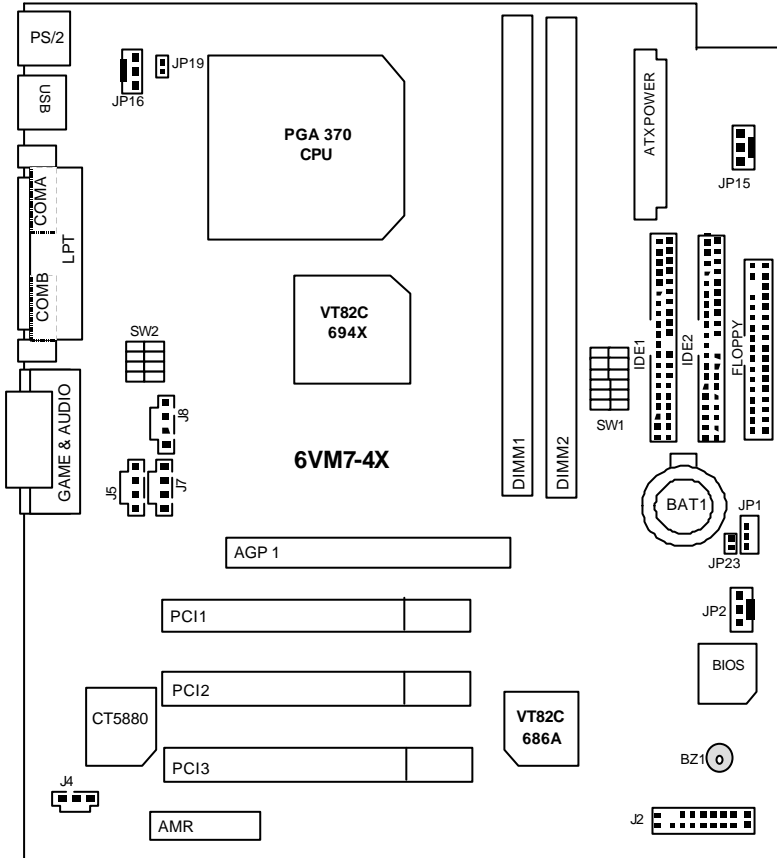

 Page Index for CPU Speed Setup / Connectors / Panel and Jumper Definition	Page
CPU Speed Setup	P.7
Connectors	P.14
GAME & Audio Port	P.14
COM A / COM B / LPT Port	P.14
USB Connector	P.15
PS/2 Keyboard & PS/2 Mouse Connector	P.15
JP16 (CPU Cooling Fan Power Connector)	P.16
JP15 (Power Cooling Fan Power Connector)	P.16
JP2 (System Cooling Fan Power Connector)	P.17
ATX Power	P.17
Floppy Port	P.18
IDE 1(Primary)/ IDE 2(Secondary) Port	P.18
J7 (TEL)	P.19
J5 (AUX_IN)	P.19
J8 (CD Audio Line In)	P.20
J4 (SPDIF)	P.20
Panel and Jumper Definition	P.21
J2 (2x11 Pins Jumper)	P.21
JP1 (Clear CMOS Function)	P.22
JP23 (Case Open)	P.22
JP19 (Support Cyrix CPU Selection)[Optional]	P.23
BAT1(Battery)	P.23

CPU Speed Setup

The system bus speed is selectable at 66,100,133MHz and Auto. The user can select the system bus speed (**SW1**) and change the DIP switch (**SW2**) selection to set up the CPU speed for 300 - 733MHz processor.

Set System Bus Speed

SW1:

O : ON, X : OFF

CPU (MHz)	PCI(MHz)	1	2	3	4	5	6
Auto	33.3	X	X	X	X	O	O
66	33.3	O	O	X	X	X	X
75	37.5	O	O	O	X	X	X
83	41.6	O	O	X	O	X	X
100	33.3	O	X	X	X	X	X
112	37.3	O	X	O	X	X	X
124	31	X	X	X	O	X	X
133	33.3	X	X	X	X	X	X
140	35	X	X	O	O	X	X
150	37.5	X	X	O	X	X	X

The CPU speed must match with the frequency ratio. It will cause system hanging up if the frequency ratio is higher than that of CPU.

SW2:

FREQ. RATIO	DIP SWITCH			
	1	2	3	4
X 3	O	X	O	O
X 3.5	X	X	O	O
X 4	O	O	X	O
X 4.5	X	O	X	O
X 5	O	X	X	O
X 5.5	X	X	X	O
X 6	O	O	O	X
X 6.5	X	O	O	X
X 7	O	X	O	X
X 7.5	X	X	O	X
X 8	O	O	X	X
X 8.5	X	O	X	X
X 9	O	X	X	X
X 9.5	X	X	X	X

☞ **For Auto Jumper Setting:**

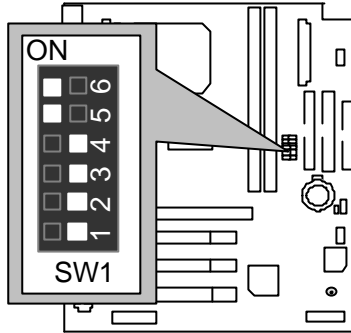

★ **Note:**

1. If you use 66/100/133 MHz CPU, We recommend you to setup your system speed to "Auto" value.
 2. We don't recommend you to set up your system speed to 75 , 83 , 112 , 124 , 140 ,150 MHz because these frequencies are not the standard specifications for CPU, Chipset and most of the peripherals. Whether your system can run under 75 ,83 ,112 ,124 ,140 ,150 MHz properly will depend on your hardware configurations: CPU, SDRAM, Cards, etc.
1. Celeron™ 300/ 66 MHz FSB

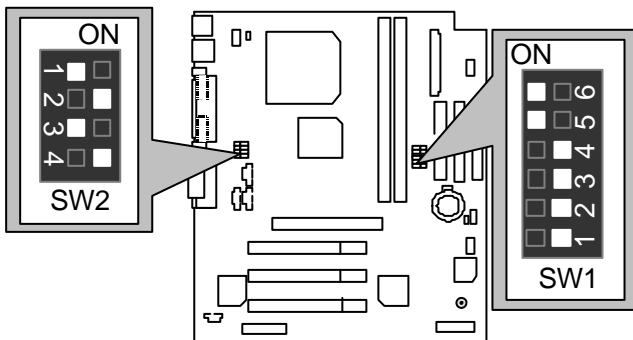

2. Celeron™ 333/ 66 MHz FSB

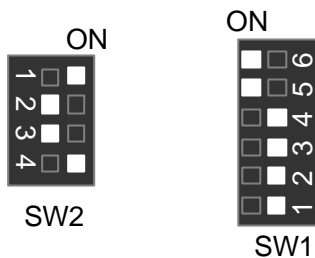

3. Celeron™ 366/ 66 MHz FSB

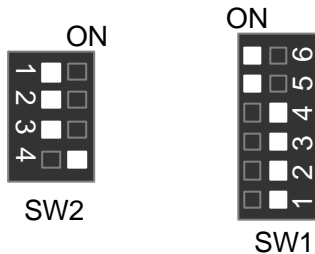

4. Celeron™ 400/ 66 MHz FSB

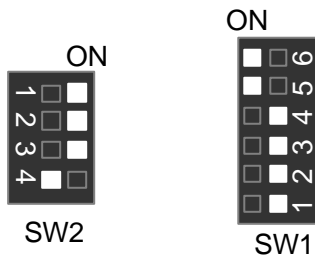

5. Celeron™ 433/ 66 MHz FSB

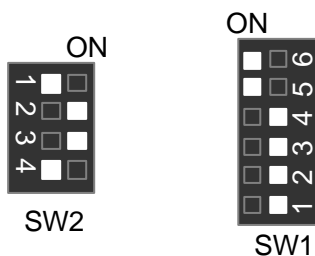

6. Celeron™ 466/ 66 MHz FSB

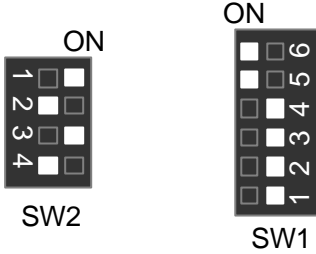

7. Celeron™ 500/ 66 MHz FSB

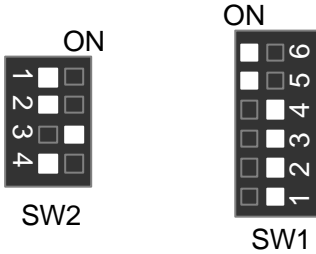

8. Celeron™ 533/ 66 MHz FSB

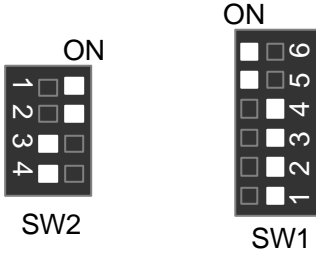

9. Celeron™ 566/ 66 MHz FSB

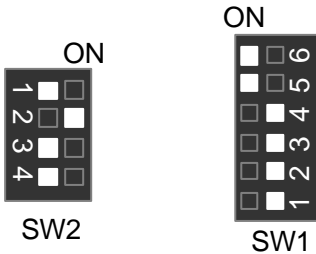

10. Cryix Joshua 300/100MHz FSB

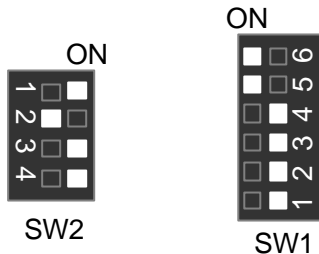

11. Pentium® !!! 500/100MHz FSB

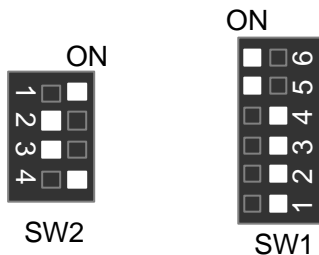

12. Pentium® !!! 550/100MHz FSB

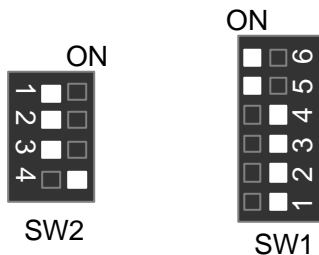

13. Pentium® !!! 600/100MHz FSB

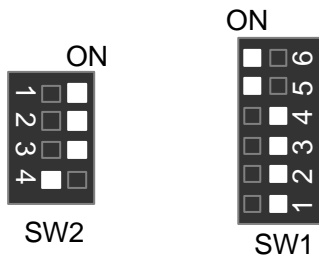

14. Pentium® !!! 650/100MHz FSB

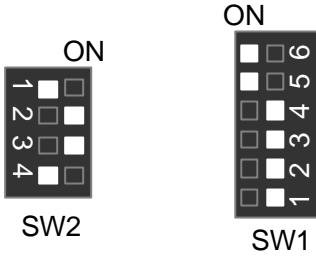

15. Pentium® !!! 700/100MHz FSB

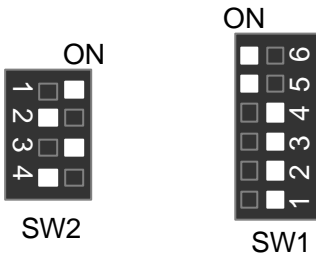

16. Pentium® !!! 533/133MHz FSB

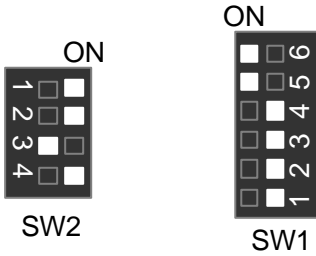

17. Pentium® !!! 600/133 MHz FSB

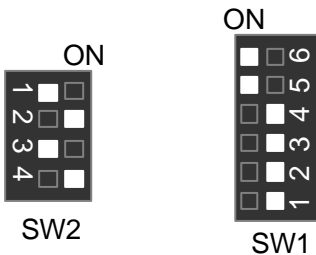

18. Pentium® !!! 667/133MHz FSB

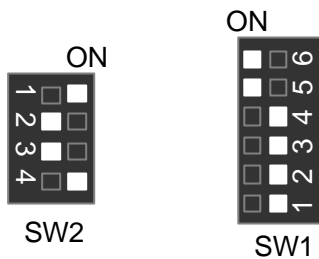

19. Pentium® !!! 733/133MHz FSB

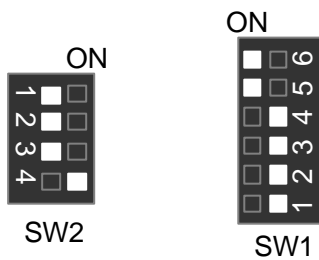

Connectors

Game & Audio Port

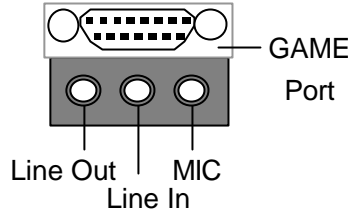
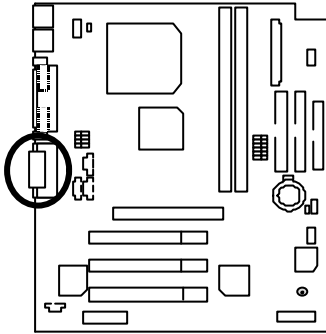

COM A / COM B / LPT Port

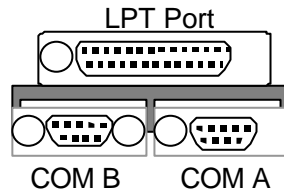
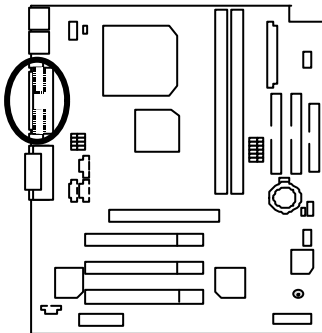

USB Connector

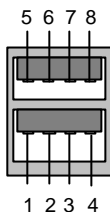
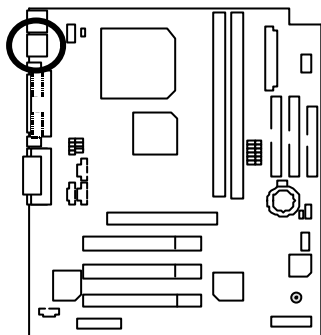

Pin No.	Definition
1	USB V0
2	USB D0-
3	USB D0+
4	GND
5	USB V1
6	USB D1-
7	USB D1+
8	GND

PS/2 Keyboard & PS/2 Mouse Connector

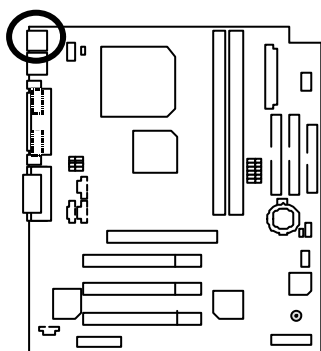

PS/2 Mouse

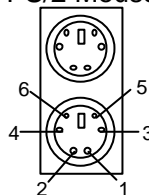

PS/2 Keyboard

PS/2 Mouse/ Keyboard	
Pin No.	Definition
1	Data
2	NC
3	GND
4	VCC(+5V)
5	Clock
6	NC

JP16: CPU Fan

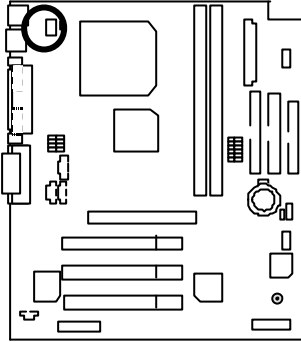

Pin No.	Definition
1	GND
2	+12V
3	SENSE

JP15: Power Fan

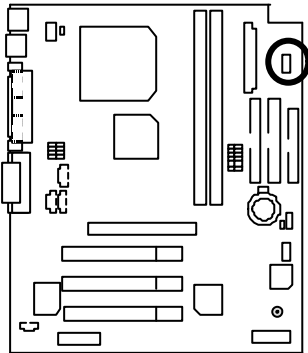

Pin No.	Definition
1	GND
2	+12V
3	NC

JP2: System Fan

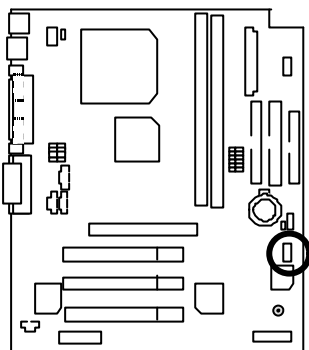

Pin No.	Definition
1	GND
2	+12V
3	SENSE

ATX Power

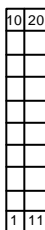
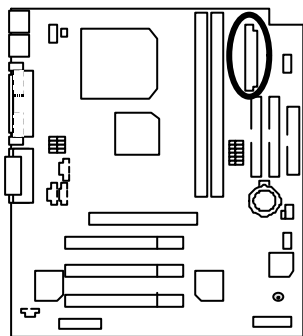

Pin No.	Definition
3,5,7,13, 15-17	GND
1,2,11	3.3V
4,6,19,20	VCC
10	+12V
12	-12V
18	-5V
8	Power Good
9	5V SB stand by+5V
14	PS-ON(Soft On/Off)

Floppy Port

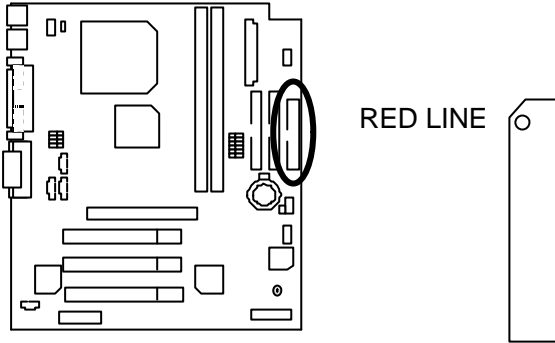

IDE1(Primary), IDE2(Secondary) Port

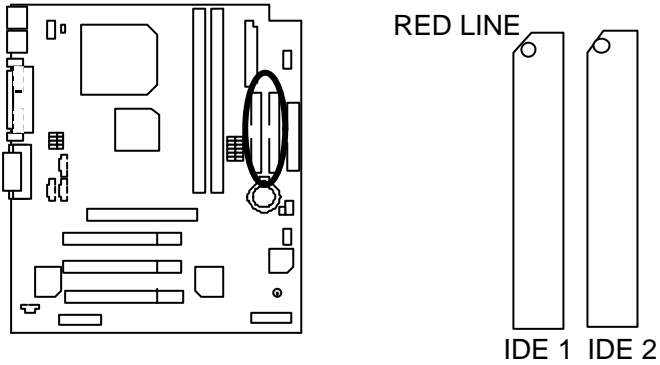

J7 : TEL: The connector is for Modem with internal voice connector

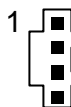
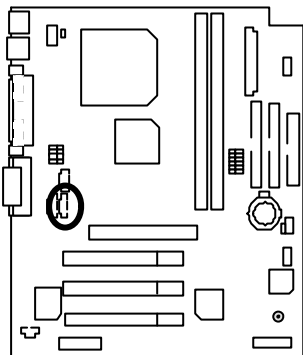

Pin No.	Definition
1	Signal-In
2	GND
3	GND
4	Signal-Out

J5:AUX_IN

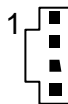
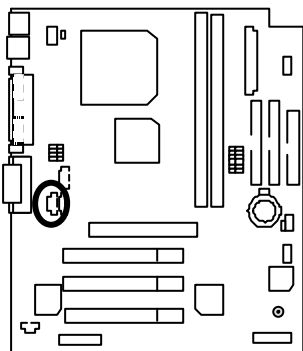

Pin No.	Definition
1	AUX-L
2	GND
3	GND
4	AUX-R

J8 : CD Audio Line In

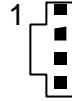
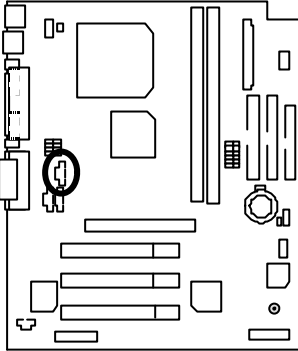

Pin No.	Definition
1	CD-L
2	GND
3	GND
4	CD-R

J4 : SPDIF(The SPDIF output is capable of providing digital audio to external speakers or compressed AC3 data to an external Dolby Digital decoder.)

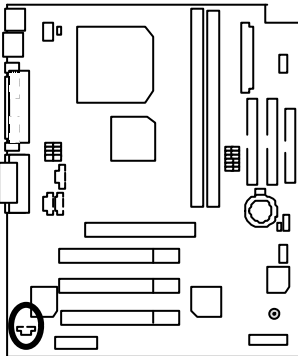

Pin No.	Definition
1	VCC
2	SPDIF OUT
3	GND

Panel and Jumper Definition

J2 : Panel Jumper

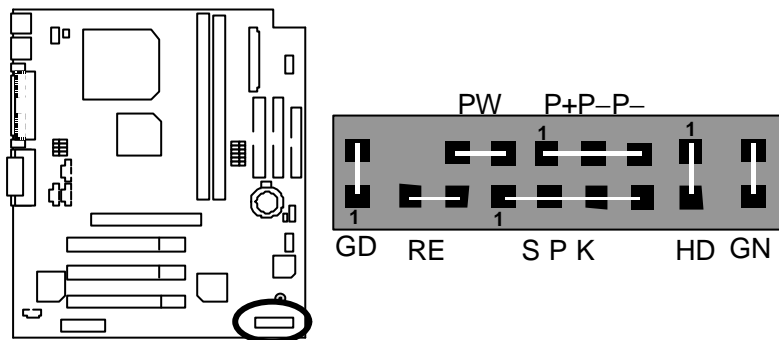

GN (Green Switch)	Open: Normal Operation Close: Entering Green Mode
GD (Green LED)	Pin 1: LED anode(+) Pin 2: LED cathode(-)
HD (IDE Hard Disk Active LED)	Pin 1: LED anode(+) Pin 2: LED cathode(-)
SPK (Speaker Connector)	Pin 1: VCC(+) Pin 2- Pin 3: NC Pin 4: Data(-)
RE (Reset Switch)	Open: Normal Operation Close: Reset Hardware System
P+P-P-(Power LED)	Pin 1: LED anode(+) Pin 2: LED cathode(-) Pin 3: LED cathode(-)
PW (Soft Power Connector)	Open: Normal Operation Close: Power On/Off

JP1 : Clear CMOS Function

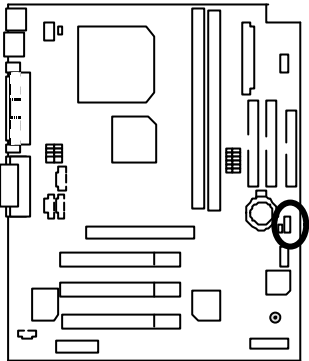

Pin No.	Definition
1-2 close	Normal (Default)
2-3 close	Clear CMOS

JP23 : Case Open

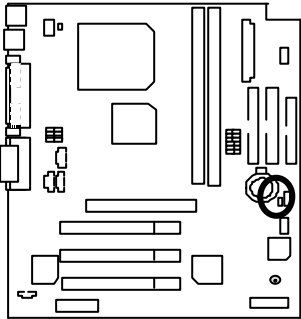

Pin No.	Definition
1	Signal
2	GND

JP19 : Support Cyrix CPU Selection(Optional)

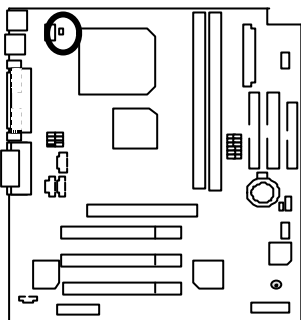

Pin No.	Definition
open	Normal
close	Support Cyrix 133MHz

BAT1 : Battery

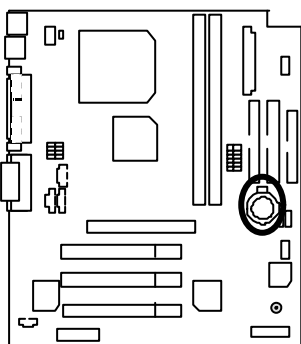

- ⚠ Danger of explosion if battery is incorrectly replaced.
- ⚠ Replace only with the same or equivalent type recommended by the manufacturer.
- ⚠ Dispose of used batteries according to the manufacturer's instructions.

Performance List

The following performance data list is the testing results of some popular benchmark testing programs.

These data are just referred by users, and there is no responsibility for different testing data values gotten by users. (The different Hardware & Software configuration will result in different benchmark testing results.)

- CPU Intel Pentium® !!! Socket 370 Processor
- DRAM (128 x 1) MB SDRAM (Micron 48LC8M8AZ-8EB)
- CACHE SIZE 256 KB included in CPU
- DISPLAY GA-660 AGP Card (32MB SDRAM)
- STORAGE Onboard IDE (IBM DTTA -371800) (18GB)
- O.S. Windows NT™ 4.0 (SP6)
- DRIVER Display Driver at 1024 x 768 x 64K x 75Hz

Processor	Intel Pentium® !!! Socket 370
	667MHz(133x5)
Winbench99	
CPU mark99	62.1
FPU Winmark 99	3570
Business Disk Winmark 99	4290
Hi-End Disk Winmark 99	8590
Business Graphics Winmark 99	312
Hi-End Graphics Winmark 99	623
Winstone99	
Business Winstone99	39.4
Hi-End Winstone99	35.4

Block Diagram

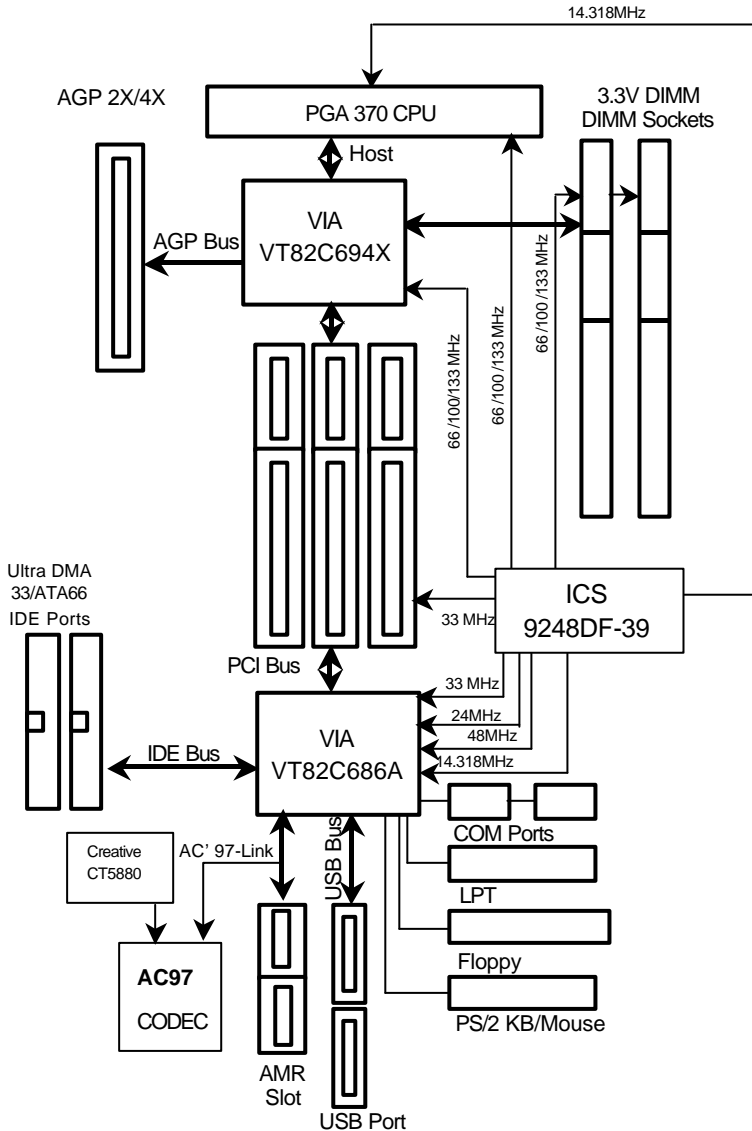

Memory Installation

The motherboard has 2 dual inline memory module (DIMM) sockets. The BIOS will automatically detects memory type and size. To install the memory module, just push it vertically into the DIMM Slot .The DIMM module can only fit in one direction due to the two notch. Memory size can vary between sockets.

Install memory in any combination table:

DIMM	168-pin SDRAM DIMM Modules	
DIMM 1	Supports 16 / 32 / 64 / 128 / 256 / 512 MB	X 1 pcs
DIMM 2	Supports 16 / 32 / 64 / 128 / 256 / 512 MB	X 1 pcs

Total System Memory (Max 1GB)

6VM7-4X Motherboard

 Page Index for BIOS Setup	Page
The Main Menu	P.29
Standard CMOS Setup	P.31
BIOS Features Setup	P.34
Chipset Features Setup	P.36
Power Management Setup	P.39
PNP/ PCI Configuration	P.42
Load BIOS Defaults	P.44
Load Setup Defaults	P.45
Integrated Peripherals	P.46
Hardware Monitor Setup	P.49
Supervisor Password / User Password	P.51
IDE HDD Auto Detection	P.52
Save to CMOS and Exit	P.53
Exit Without Saving	P.54

BIOS Setup

BIOS Setup is an overview of the BIOS Setup Program. The program that allows users to modify the basic system configuration. This type of information is stored in battery-backed CMOS RAM so that it retains the Setup information when the power is turned off.

ENTERING SETUP

Power ON the computer and press immediately will allow you to enter Setup. If the message disappears before you respond and you still wish to enter Setup, restart the system to try again by turning it OFF then ON or pressing the "RESET" bottom on the system case. You may also restart by simultaneously press <Ctrl> – <Alt> – keys.

CONTROL KEYS

<↑>	Move to previous item
<↓>	Move to next item
<←>	Move to the item in the left hand
<→>	Move to the item in the right hand
<Esc>	Main Menu - Quit and not save changes into CMOS Status Page Setup Menu and Option Page Setup Menu - Exit current page and return to Main Menu
<+/PgUp>	Increase the numeric value or make changes
<-/PgDn>	Decrease the numeric value or make changes
<F1>	General help, only for Status Page Setup Menu and Option Page Setup Menu
<F2>	Reserved
<F3>	Reserved
<F4>	Reserved
<F5>	Restore the previous CMOS value from CMOS, only for Option Page Setup Menu
<F6>	Load the default CMOS value from BIOS default table, only for Option Page Setup Menu
<F7>	Load the Setup Defaults.
<F8>	Reserved
<F9>	Reserved
<F10>	Save all the CMOS changes, only for Main Menu

GETTING HELP

Main Menu

The on-line description of the highlighted setup function is displayed at the bottom of the screen.

Status Page Setup Menu / Option Page Setup Menu

Press F1 to pop up a small help window that describes the appropriate keys to use and the possible selections for the highlighted item. To exit the Help Window press <Esc>.

The Main Menu

Once you enter AMI BIOS CMOS Setup Utility, the Main Menu (Figure 1) will appear on the screen. The Main Menu allows you to select from nine setup functions and two exit choices. Use arrow keys to select among the items and press <Enter> to accept or enter the sub-menu.

AMIBIOS SIMPLE SETUP UTILITY-VERSION 1.20C (C) 1999 American Megatrends, Inc. All Rights Reserved	
STANDARD CMOS SETUP	INTEGRATED PERIPHERALS
BIOS FEATURES SETUP	HARDWARE MONITOR SETUP
CHIPSET FEATURES SETUP	SUPERVISOR PASSWORD
POWER MANAGEMENT SETUP	USER PASSWORD
PNP/PCI CONFIGURATION	IDE HDD AUTO DETECTION
LOAD BIOS DEFAULTS	SAVE & EXIT SETUP
LOAD SETUP DEFAULTS	EXIT WITHOUT SAVING
ESC : Quit ↑↓←→ : Select Item (Shift) F2 : Change Color F5 : Old Values F6 : Load BIOS Defaults F7: Load Setup Defaults F10: Save & Exit	
Time, Date, Hard Disk Type, ...	

Figure 1: Main Menu

- **Standard CMOS Setup**

This setup page includes all the items in standard compatible BIOS.

- **BIOS Features Setup**

This setup page includes all the items of AMI special enhanced features.

- **Chipset Features Setup**

This setup page includes all the items of chipset special features.
- **Power Management Setup**

This setup page includes all the items of Green function features.
- **PnP/PCI Configurations**

This setup page includes all the configurations of PCI & PnP ISA resources.
- **Load BIOS Defaults**

Bios Defaults indicates the value of the system parameter which the system would be in the safe configuration.
- **Load Setup Defaults**

Setup Defaults indicates the value of the system parameter which the system would be in the most appropriate configuration.
- **Integrated Peripherals**

This setup page includes all onboard peripherals.
- **Hardware Monitor Setup**

This setup page is auto detect fan and temperature status.
- **Supervisor password**

Change, set, or disable password. It allows you to limit access to the system and Setup, or just to Setup.
- **User password**

Change, set, or disable password. It allows you to limit access to the system.
- **IDE HDD auto detection**

Automatically configure hard disk parameters.
- **Save & Exit Setup**

Save CMOS value settings to CMOS and exit setup.
- **Exit Without Saving**

Abandon all CMOS value changes and exit setup.

Standard CMOS Setup

The items in Standard CMOS Features Menu (Figure 2) are divided into 9 categories. Each category includes no, one or more than one setup items. Use the arrows to highlight the item and then use the <PgUp> or <PgDn> keys to select the value you want in each item.

AMIBIOS SETUP – STANDARD CMOS SETUP (C) 1999 American Megatrends, Inc. All Rights Reserved									
Date (mm/dd/yyyy) : Web Oct 27, 1999									
Time (hh/mm/ss) : 10:36:24									
	TYPE	SIZE	CYLS	HEAD	PRECOMP	LANDZ	SECTOR	MODE	
Pri Master	:	Auto							
Pri Slave	:	Auto							
Sec Master	:	Auto							
Sec Slave	:	Auto							
Floppy Drive A:	:	1.44 MB 3 ½							
Floppy Drive B:	:	Not Installed							
Boot Sector Virus Protection	:	Disabled							
					Base Memory : 640 Kb				
					Other Memory : 384 Kb				
					Extended Memory : 30Mb				
					Total Memory : 31Mb				
Month:	Jan	–	Dec						ESC : Exit
Day:	01	–	31						↑↓ : Select Item
Year :	2000	–	2099						PU/PD/+/- : Modify (Shift)F2 : Color

Figure 2: Standard CMOS Setup

- **Date**

The date format is <Week>, <Month>, <Day>, <Year>.

Week	The week, from Sun to Sat, determined by the BIOS and is display-only
Month	The month, Jan. Through Dec.
Day	The day, from 1 to 31 (or the maximum allowed in the month)
Year	The year, from 2000 through 2099

- **Time**

The times format in <hour> <minute> <second>. The time is calculated base on the 24-hour military-time clock. For example, 1 p.m. is 13:00:00.

- **IDE Primary Master, Slave / Secondary Master, Slave**

The category identifies the types of hard disk from drive C to F that has been installed in the computer. There are two types: auto type, and user definable type. User type is user-definable; Auto type which will automatically detect HDD type.

Note that the specifications of your drive must match with the drive table. The hard disk will not work properly if you enter improper information for this category.

If you select User Type, related information will be asked to enter to the following items. Enter the information directly from the keyboard and press <Enter>. Such information should be provided in the documentation form your hard disk vendor or the system manufacturer.

CYLS.	Number of cylinders
HEADS	number of heads
PRECOMP	write precomp
LANDZONE	Landing zone
SECTORS	number of sectors

If a hard disk has not been installed select NONE and press <Enter>.

- **Drive A type / Drive B type**

The category identifies the types of floppy disk drive A or drive B that has been installed in the computer.

None	No floppy drive installed
360K, 5.25 in.	5.25 inch PC-type standard drive; 360K byte capacity.
1.2M, 5.25 in.	5.25 inch AT-type high-density drive; 1.2M byte capacity (3.5 inch when 3 Mode is Enabled).
720K, 3.5 in.	3.5 inch double-sided drive; 720K byte capacity
1.44M, 3.5 in.	3.5 inch double-sided drive; 1.44M byte capacity.
2.88M, 3.5 in.	3.5 inch double-sided drive; 2.88M byte capacity.

- **Boot Sector Virus Protection**

If it is set to enable, the category will flash on the screen when there is any attempt to write to the boot sector or partition table of the hard disk drive. The system will halt and the following error message will appear in the mean time. You can run anti-virus program to locate the problem.

Enabled	Activate automatically when the system boots up causing a warning message to appear when anything attempts to access the boot sector or hard disk partition table
Disabled	No warning message to appear when anything attempts to access the boot sector or hard disk partition table. (Default Value)

- **Memory**

The category is display-only which is determined by POST (Power On Self Test) of the BIOS.

Base Memory

The POST of the BIOS will determine the amount of base (or conventional) memory installed in the system.

The value of the base memory is typically 512 K for systems with 512 K memory installed on the motherboard, or 640 K for systems with 640 K or more memory installed on the motherboard.

Extended Memory

The BIOS determines how much extended memory is present during the POST.

This is the amount of memory located above 1 MB in the CPU's memory address map.

Other Memory

This refers to the memory located in the 640 K to 1024 K address space. This is memory that can be used for different applications.

DOS uses this area to load device drivers to keep as much base memory free for application programs. Most use for this area is Shadow RAM

BIOS Features Setup

AMBIOS SETUP – BIOS FEATURES CMOS SETUP (C) 1999 American Megatrends, Inc. All Rights Reserved	
1st Boot Device	:Floppy
2nd Boot Device	:IDE-0
3rd Boot Device	:CDROM
S.M.A.R.T for Hard Disks	:Disabled
BootUp Num-Lock	:On
Floppy Drive Seek	:Disabled
Password Check	:Setup
Processor Serial Number	:Disabled
<p style="text-align: right;">ESC : Quit ↑↓←→: Select Item F1 : Help PU/PD/+/- : Modify F5 : Old Values (Shift)F2 :Color F6 : Load BIOS Defaults F7 : Load Setup Defaults</p>	

Figure 3: BIOS Features Setup

- 1st / 2nd / 3rd Boot Device**

The default value is Floppy or LS-120 / ZIP A: or ATAPI ZIP C: or CDROM or SCSI or NETWORK / I20 or IDE-0-IDE-3 or Disabled.

Floppy	Boot Device by Floppy.
LS-120 / ZIP A:	Boot Device by LS-120 / ZIP A:.
CDROM	Boot Device by CDROM.
SCSI	Boot Device by SCSI.
NETWORK	Boot Device by NETWORK.
IDE-0-IDE-3	Boot Device by IDE-0-IDE-3.
Disabled	Boot Device by Disabled.
ATAPI ZIP C:	Boot Device by ATAPI ZIP C:.

- S.M.A.R.T. for Hard Disks**

Enable	Enable S.M.A.R.T. Hard for Disks.
Disable	Disable S.M.A.R.T. Hard for Disks. (Default Value)

- **Boot Up Num-Lock**

On	Keypad is number keys. (Default Value)
Off	Keypad is arrow keys.

- **Floppy Drive Seek**

During POST, BIOS will determine if the floppy disk drive installed is 40 or 80 tracks. 360 type is 40 tracks while 720 , 1.2 and 1.44 are all 80 tracks.

Enabled	BIOS searches for floppy disk drive to determine if it is 40 or 80 tracks. Note that BIOS can not tell from 720, 1.2 or 1.44 drive type as they are all 80 tracks.
Disabled	BIOS will not search for the type of floppy disk drive by track number. Note that there will not be any warning message if the drive installed is 360. (Default Value)

- **Password Check**

Setup	Set Password Check to Setup. (Default Value)
Always	Set Password Check to Always.

- **Processor Serial Number**(Only Support Pentium® !!! Processor)

Disabled	Disabled Processor Serial Number. (Default Value)
Enabled	Enabled Processor Serial Number.

Chipset Features Setup

AMIBIOS SETUP –CHIPSET FEATURE CMOS SETUP (C) 1999 American Megatrends, Inc. All Rights Reserved	
*** DRAM Timing ***	
Top Performance	:Disabled
SDRAM Timing by SPD	:Disabled
SDRAM CAS# Latency	:3
DRAM Frequency	:Auto
C2P Concurrency & Master	:Enabled
DRAM Integrity Mode	:Disabled
AGP Mode	:4X
AGP Comp. Driving	:Auto
Manual AGP Comp. Driving	:CB
AGP Aperture Size	:64MB
USB Controller	:USB Port 0&1
USB Legacy Support	:Disabled
ESC : Quit ↑↔→: Select Item F1 : Help PU/PD/+/- : Modify F5 : Old Values (Shift)F2 :Color F6 : Load BIOS Defaults F7 : Load Setup Defaults	

Figure 4: Chipset Features Setup

- **Top Performance**

Disabled	Set Top Performance is disabled. (Default Value)
Enabled	Set Top Performance is enabled.

- **SDRAM Timing by SPD**

Disabled	SDRAM Timing by SPD Function Disabled. (Default Value)
Enabled	SDRAM Timing by SPD Function Enabled.

- **SDRAM CAS# Latency**

3	For Slower SDRAM DIMM module. (Default Value)
2	For Fastest SDRAM DIMM module.

- **DRAM Frequency**

Auto	Set DRAM Frequency automation. (Default Value)
100MHz	Set DRAM Frequency is 100MHz.
66MHz	Set DRAM Frequency is 66MHz.
133MHz	Set DRAM Frequency is 133MHz.

- **C2P Concurrency & Master**

Enabled	Enabled C2P Concurrency & Master. (Default Value)
Disabled	Disabled C2P Concurrency & Master.

- **DRAM Integrity Mode**

ECC	For 72 bit ECC type DIMM Modle.
Disabled	Normal Setting. (Default Value)

- **AGP Mode**

4X	Set AGP Mode is 4X. (Default Value)
1X	Set AGP Mode is 1X.
2X	Set AGP Mode is 2X.

- **AGP Comp. Driving**

Auto	Set AGP Comp. Driving is Auto. (Default Value)
Manual	Set AGP Comp. Driving is Manual.

If AGP Comp. Driving is Manual.

Manual AGP Comp. Driving :	00-FF
----------------------------	-------

- **AGP Aperture Size**

4MB	Set AGP Aperture Size to 4MB.
8MB	Set AGP Aperture Size to 8 MB.
16MB	Set AGP Aperture Size to 16 MB.
32MB	Set AGP Aperture Size to 32 MB.
64MB	Set AGP Aperture Size to 64 MB. (Default Value)
128MB	Set AGP Aperture Size to 128 MB.
256MB	Set AGP Aperture Size to 256 MB.

- **USB Controller**

USB Port 0&1	Set USB Controller Function is USB Port 0&1. (Default Value)
Disabled	USB Controller Function Disabled.

- **USB Legacy Support**

Keyboard	Set USB Legacy Support Keyboard.
Keyb+Mouse	Set USB Legacy Support Keyboard +Mouse.
Disabled	Disabled USB Legacy Support Function. (Default Value)

Power Management Setup

AMBIOS SETUP –POWER MANAGEMENT SETUP			
(C) 1999 American Megatrends, Inc. All Rights Reserved			
Video Power Down Mode	:Stand by	RTC Alarm Date	:15
Hard Disk Power Down Mode	:Stand by	RTC Alarm Hour	:12
Suspend Time Out(Minute)	:Disabled	RTC Alarm Minute	:30
Display Activity	:Ignore	RTC Alarm Second	:30
IRQ3	:Monitor		
IRQ 4	:Monitor		
IRQ 5	:Ignore		
IRQ 7	:Monitor		
IRQ 9	:Ignore		
IRQ 10	:Ignore		
IRQ 11	:Ignore		
IRQ 13	:Ignore		
IRQ 14	:Monitor		
IRQ 15	:Ignore		
Soft-off by Power Button	:Instant off		
AC Back Function	:Last state	ESC : Quit	↑↓←→: Select Item
Modem Use IRQ	:4	F1 : Help	PU/PD/+/- : Modify
Modem Ring On /Wake On Lan	:Enabled	F5 : Old Values (Shift)F2	:Color
PME Event Wake up	:Enabled	F6 : Load BIOS Defaults	
RTC Alarm Power On	:Disabled	F7 : Load Setup Defaults	

Figure 5: Power Management Setup

- **Video Power Down Mode**

Disabled	Disabled Video Power Down Mode Function.
Suspend	Set Video Power Down Mode to Suspend. (Default Value)
Stand By	Set Video Power Down Mode to Stand By.

- **Hard Disk Power Down Mode**

Disabled	Disabled Hard Disk Power Down Mode Function.
Suspend	Set Hard Disk Power Down Mode to Suspend (Default Value)
Stand By	Set Hard Disk Power Down Mode to Stand By.

• **Suspend Time Out (Minute.)**

Disabled	Disabled Suspend Time Out Function. (Default Value)
1	Enabled Suspend Time Out after 1min.
2	Enabled Suspend Time Out after 2min.
4	Enabled Suspend Time Out after 4min.
8	Enabled Suspend Time Out after 8min.
10	Enabled Suspend Time Out after 10min.
20	Enabled Suspend Time Out after 20min.
30	Enabled Suspend Time Out after 30min.
40	Enabled Suspend Time Out after 40min.
50	Enabled Suspend Time Out after 50min.
60	Enabled Suspend Time Out after 60min.

• **Display Activity**

Ignore	Ignore Display Activity. (Default Value)
Monitor	Monitor Display Activity.

• **IRQ 3~IRQ15**

Ignore	Ignore IRQ3 ~IRQ15.
Monitor	Monitor IRQ3~IRQ15.

• **Soft-off by Power Button**

Instant off	Soft switch ON/OFF for Power Button. (Default Value)
Delay-4Sec	Soft switch ON 4 Sec for Power off.

• **AC Back Function**

Power Off	Set Restore on AC/Power Loss is Power off.
Power On	Set Restore on AC/Power Loss is Power on.
Last state	Set Restore on AC/Power Loss is Last state mode. (Default Value)

• **MODEM Use IRQ**

NA	Set MODEM Use IRQ to NA.
3	Set MODEM Use IRQ to 3.
4	Set MODEM Use IRQ to 4. (Default Value)
5	Set MODEM Use IRQ to 5.
7	Set MODEM Use IRQ to 7.

- **Modem Ring On / Wake On Lan**

Disabled	Disabled Modem Ring On / Wake On Lan function.
Enabled	Enabled Modem Ring On / Wake On Lan function. (Default Value)

- **PME Event Wake up**

Disabled	Disabled PME Event Wake up function.
Enabled	Enabled PME Event Wake up function. (Default Value)

- **RTC Alarm Power On**

Disabled	Disable this function. (Default Value)
Enabled	Enable alarm function to POWER ON system.

If RTC Alarm Lead To Power On is Enabled.

RTC Alarm Date :	Every Day,1~31
RTC Alarm Hour:	0~23
RTC Alarm Minute :	0~59
RTC Alarm Second :	0~59

PnP/PCI Configurations

AMIBIOS SETUP –PNP/PCI CONFIGURATION SETUP (C) 1999 American Megatrends, Inc. All Rights Reserved	
Plug and Play Aware O/S	:No
Reset Configuration Data	:No
VGA Boot From	:AGP
PCI VGA Palette Snoop	:Disabled
DMA Channel 0	:PnP
DMA Channel 1	:PnP
DMA Channel 3	:PnP
DMA Channel 5	:PnP
DMA Channel 6	:PnP
DMA Channel 7	:PnP
IRQ 3	:PCI/PnP
IRQ 4	:PCI/PnP
IRQ 5	:PCI/PnP
IRQ 7	:PCI/PnP
IRQ 9	:PCI/PnP
IRQ 10	:PCI/PnP
IRQ 11	:PCI/PnP
IRQ 14	:PCI/PnP
IRQ 15	:PCI/PnP

ESC	: Quit	↑↓←→	: Select Item
F1	: Help	PU/PD/+/-	: Modify
F5	: Old Values	(Shift)F2	:Color
F6	: Load BIOS Defaults		
F7	: Load Setup Defaults		

Figure 6: PnP/PCI Configuration

- **Plug and Play Aware O/S**

Yes	Enable Plug and Play Aware O/S function.
No	Disable Plug and Play Aware O/S function (Default Value)

- **Reset Configuration Data**

Yes	Reset configuration data.
No	Disabled this function. (Default Value)

- **VGA Boot From**

AGP	Set VGA Boot From AGP. (Default Value)
PCI	Set VGA Boot From PCI.

- **PCI VGA Palette Snoop**

Enabled	For having Video Card on ISA Bus and VGA Card on PCI Bus.
Disabled	For VGA Card only. (Default Value)

- **DMA Channel (0,1,3,5,6,7)**

PnP	The resource is used by PnP device.
ISA/EISA	The resource is used by ISA / EISA device (PCI or ISA).

- **IRQ (3,4,5,7, 9,10,11,14,15)**

PCI/PnP	The resource is used by PCI/PnP device.
ISA/EISA	The resource is used by ISA / EISA device (PCI or ISA).

Load BIOS Defaults

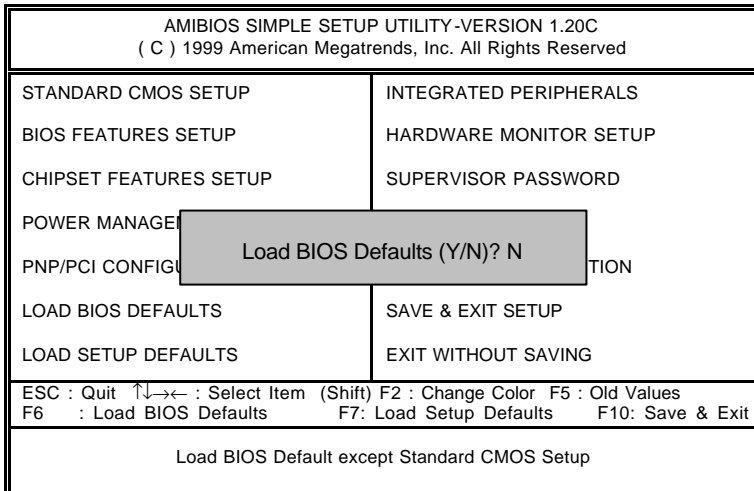

Figure 7: Load BIOS Defaults

- **Load BIOS Defaults**

BIOS defaults contain the most appropriate values of the system parameters that allow minimum system performance.

Load Setup Defaults

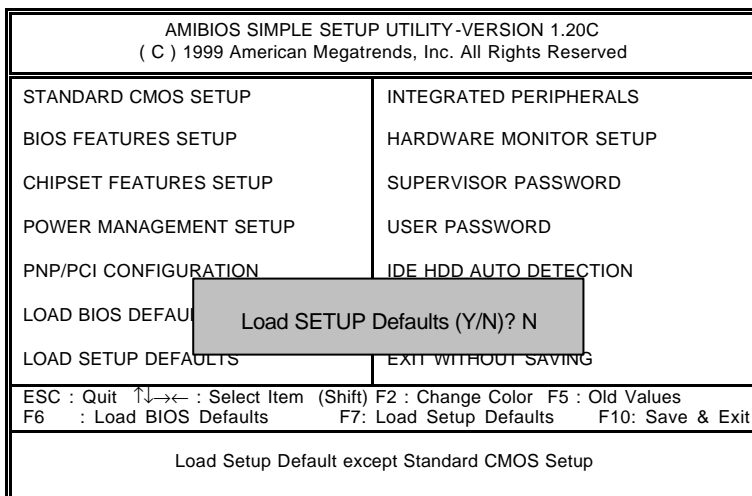

Figure 8: Load Setup Defaults

- **Load Setup Defaults**

Selecting this field loads the factory defaults for BIOS and Chipset Features which the system automatically detects.

Integrated Peripherals

AMIBIOS SETUP –INTEGRATED PERIPHERAL (C) 1999 American Megatrends, Inc. All Rights Reserved	
OnBoard IDE	:Both
OnBoard FDC	:Auto
OnBoard Serial Port 1	:Auto
OnBoard Serial Port 2	:Auto
OnBoard Parallel Port	:Auto
Parallel Port Mode	:ECP
Parallel Port DMA	:Auto
Parallel Port IRQ	:Auto
OnBoard AC' 97 Audio	:Disabled
OnBoard MC' 97 Modem	:Auto
OnBoard Sound	:Enabled
ESC : Quit ↑↓←→: Select Item F1 : Help PU/PD/+/- : Modify F5 : Old Values (Shift)F2 :Color F6 : Load BIOS Defaults F7 : Load Setup Defaults	

Figure 9: Integrated Peripherals

- **OnBoard IDE**

Disabled	Disabled OnBoard IDE
Both	Set OnBoard IDE is Both. (Default Value)
Primary	Set OnBoard IDE is Primary.
Secondary	Set OnBoard IDE is Secondary.

- **OnBoard FDC**

Auto	Set OnBoard FDC is Auto. (Default Value)
Disabled	Disabled OnBoard FDC.
Enabled	Enabled OnBoard FDC.

- **OnBoard Serial Port 1**

Auto	BIOS will automatically setup the port 1 address. (Default Value)
3F8/COM1	Enable onBoard Serial port 1 and address is 3F8.
2F8/COM2	Enable onBoard Serial port 1 and address is 2F8.
3E8/COM3	Enable onBoard Serial port 1 and address is 3E8.
2E8/COM4	Enable onBoard Serial port 1 and address is 2E8.
Disabled	Disable onBoard Serial port 1.

- **OnBoard Serial Port 2**

Auto	BIOS will automatically setup the port 2 address. (Default Value)
3F8/COM1	Enable onBoard Serial port 2 and address is 3F8.
2F8/COM2	Enable onBoard Serial port 2 and address is 2F8.
3E8/COM3	Enable onBoard Serial port 2 and address is 3E8.
2E8/COM4	Enable onBoard Serial port 2 and address is 2E8.
Disabled	Disable onBoard Serial port 2.

- **OnBoard Parallel port**

378	Enable On Board LPT port and address is 378.
278	Enable On Board LPT port and address is 278.
3BC	Enable On Board LPT port and address is 3BC.
Auto	Set On Board LPT port is Auto. (Default Value)
Disabled	Disable On Board LPT port.

- **Parallel Port Mode**

EPP	Using Parallel port as Enhanced Parallel Port.
ECP	Using Parallel port as Extended Capabilities Port. (Default Value)
Normal	Normal Operation.
N/A	Disabled this function.

- **Parallel Port DMA**

Auto	Set Auto to parallel port mode DMA Channel. (Default Value)
N/A	Disabled this function.
3	Set Parallel Port DMA is 3.
1	Set Parallel Port DMA is 1.
0	Set Parallel Port DMA is 0.

- **Parallel Port IRQ**

Auto	Set Auto to parallel Port IRQ DMA Channel. (Default Value)
N/A	Disabled this function.
5	Set Parallel Port IRQ is 5.
7	Set Parallel Port IRQ is 7.

- **OnBoard AC' 97 Audio**

Auto	Set AC' 97 Audio to Auto.
Disabled	Disabled AC' 97 Audio. (Default Value)

- **OnBoard MC' 97 Modem**

Auto	Set MC' 97 Modem to Auto. (Default Value)
Disabled	Disabled MC' 97 Modem.

- **OnBoard Sound**

Enabled	Enabled OnBoard Sound. (Default Value)
Disabled	Disabled OnBoard Sound.

Hardware Monitor

AMIBIOS SETUP –HARDWARE MONITOR	
(C) 1999 American Megatrends, Inc. All Rights Reserved	
ACPI Shut Down Temperature	:65°C/149°F
Current CPU Temp.	:36°C/96°F
Current System Temp.	:28°C/82°F
Case Status	Closed
Current CPU Fan Speed	:5487 RPM
Current System Fan Speed	:0 RPM
Vcore	:2.075V
+3.300V	:3.590V
+5.000V	:5.119V
+12.000V	:11.926V
ESC : Quit ↑←→: Select Item F1 : Help PU/PD/+/- : Modify F5 : Old Values (Shift)F2 :Color F6 : Load BIOS Defaults F7 : Load Setup Defaults	

Figure 10: Hardware Monitor

- **ACPI Shutdown Temp. (°C / °F)**

(This function will be effective only for the operating systems that support ACPI Function.)

Disabled	Disable ACPI Shutdown function.
60°C / 140°F	Monitor CPU Temp. at 60°C / 140°F, if Temp. > 60°C / 140°F system will automatically power off.
65°C / 149°F	Monitor CPU Temp. at 65°C / 149°F, if Temp. > 65°C / 149°F system will automatically power off. (Default Value)
70°C / 158°F	Monitor CPU Temp. at 70°C / 158°F, if Temp. > 70°C / 158°F system will automatically power off.
75°C / 167°F	Monitor CPU Temp. at 75°C / 167°F, if Temp. > 75°C / 167°F system will automatically power off.

- **Current CPU Temp. (°C / °F)**

Detect CPU Temperature automatically.

- **Current System Tem. (°C / °F)**

Detect System Temperature automatically.

- **Case Status**

If the case is closed, "Case Status" will show "Closed".

If the case have been opened, "Case Opened" will show "Open".

- **Current CPU FAN Speed**

Detect CPU Fan speed status automatically.

- **Current System FAN Speed**

Detect System Fan speed status automatically.

- **Current Voltage (V) VCORE / +3.3V / +12V / +5V**

Detect system's voltage status automatically.

Set Supervisor / User Password

When you select this function, the following message will appear at the center of the screen to assist you in creating a password.

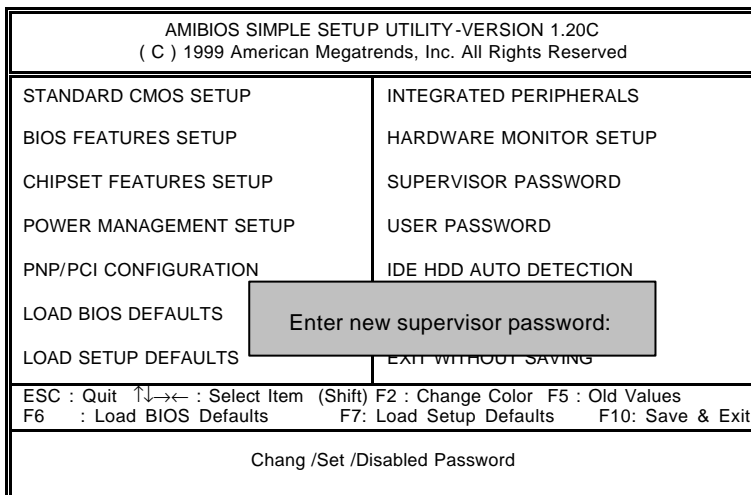

Figure 11: Password Setting

Type the password, up to eight characters, and press <Enter>. The password typed now will clear the previously entered password from CMOS memory. You will be asked to confirm the password. Type the password again and press <Enter>. You may also press <Esc> to abort the selection and not enter a password.

To disable password, just press <Enter> when you are prompted to enter password. A message "PASSWORD DISABLED" will appear to confirm the password being disabled. Once the password is disabled, the system will boot and you can enter Setup freely.

If you select "Always" at "Password Check" Option in BIOS Features Setup Menu, you will be prompted for the password every time the system is rebooted or any time you try to enter Setup Menu. If you select "Setup" at "Password Check" Option in BIOS Features Setup Menu, you will be prompted only when you try to enter Setup.

IDE HDD AUTO Detection

AMIBIOS SETUP – STANDARD CMOS SETUP (C) 1999 American Megatrends, Inc. All Rights Reserved							
Date (mm/dd/yyyy) : Sat Jan 01, 2000							
Time (hh/mm/ss) : 10:36:24							
	TYPE	SIZE	CYLS	HEAD	PRECOMP	LANDZ	SECTOR MODE
Pri Master : Not Installed							
Pri Slave : Not Installed							
Sec Master : Not Installed							
Sec Slave : Not Installed							
Floppy Drive A: 1.44 MB 3 ½				Base Memory : 640 Kb			
Floppy Drive B: Not Installed				Other Memory: 384 Kb			
				Extended Memory: 31Mb			
Boot Sector Virus Protection : Disabled				Total Memory: 32Mb			
Month: Jan – Dec				ESC : Exit			
Day: 01 – 31				↑↓ : Select Item			
Year : 2000– 2099				PU/PD/+/- : Modify			
				(Shift)F2 : Color			

Figure 12: IDE HDD Auto Detection

Type "Y" will accept the H.D.D. parameter reported by BIOS.

Type "N" will keep the old H.D.D. parameter setup. If the hard disk cylinder number is over 1024, then the user can select LBA mode or LARGER mode for DOS partition larger than 528 MB.

Save & Exit Setup

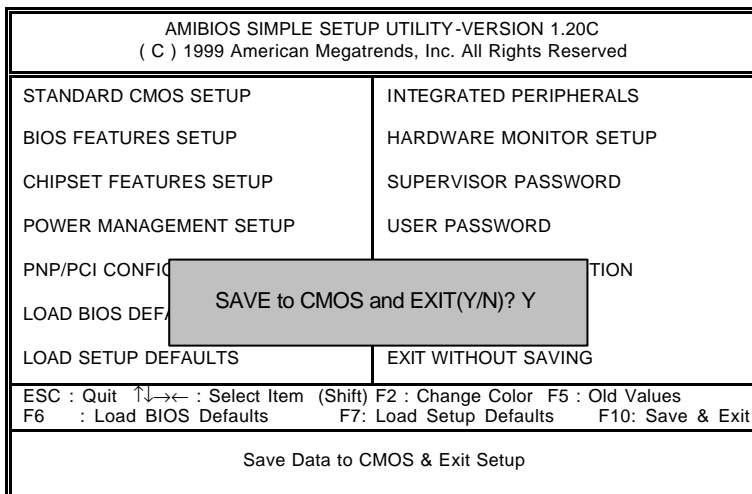

Figure 13: Save & Exit Setup

Type "Y" will quit the Setup Utility and save the user setup value to RTC CMOS.

Type "N" will return to Setup Utility.

Exit Without Saving

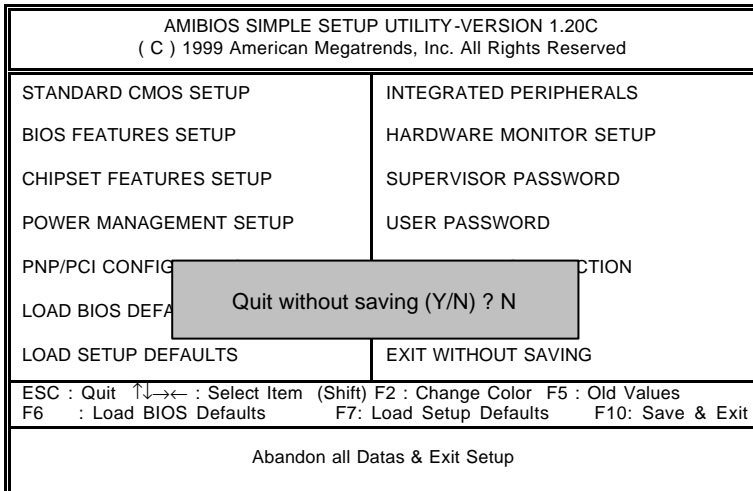

Figure 14: Exit Without Saving

Type "Y" will quit the Setup Utility without saving to RTC CMOS.

Type "N" will return to Setup Utility.

Appendix

Appendix A: VIA Series VT82C686A Chipsets Driver Installation

A. VIA 4 in 1 Service Pack Utility:

Insert the support CD that came with your motherboard into your CD-ROM driver or double-click the CD driver icon in My Computer to bring up the screen.

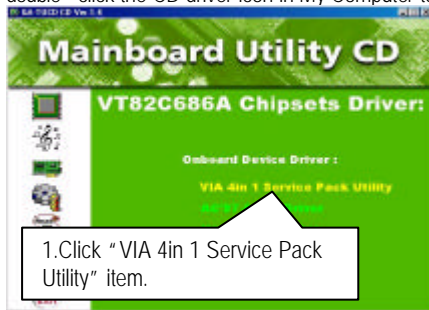

(1)

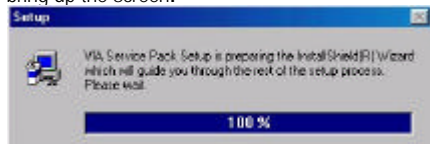

(2)

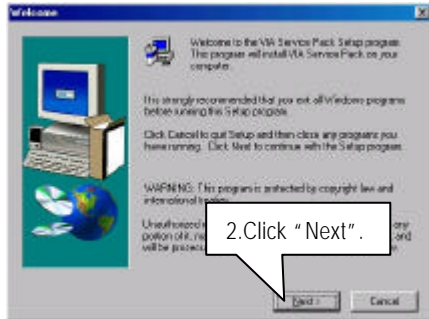

(3)

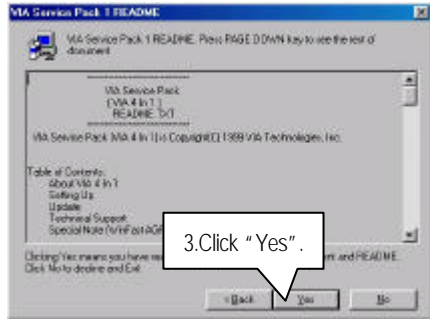

(4)

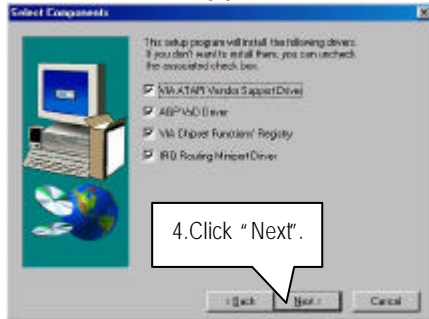

(5)

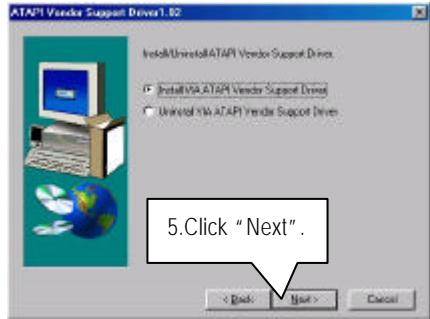

(6)

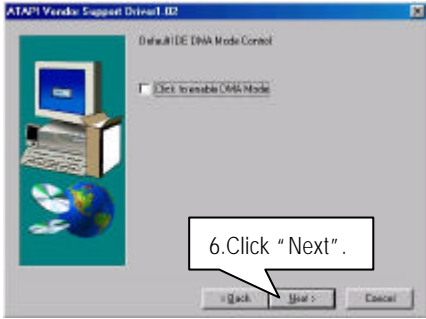

(7)

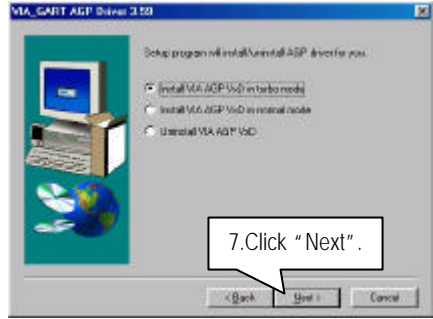

(8)

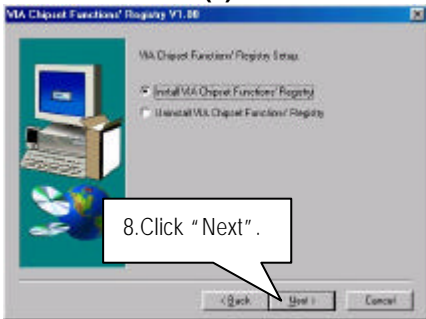

(9)

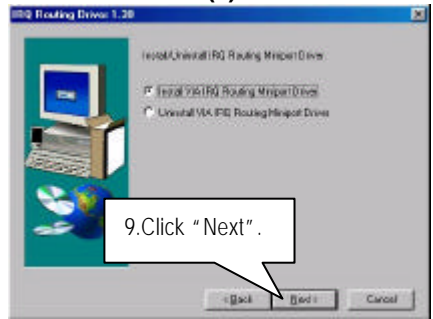

(10)

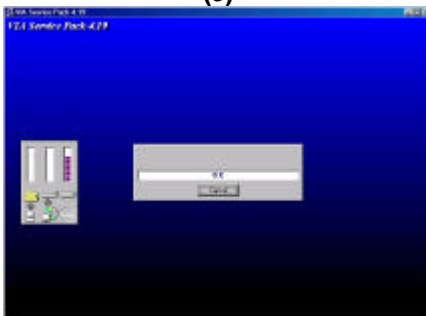

(11)

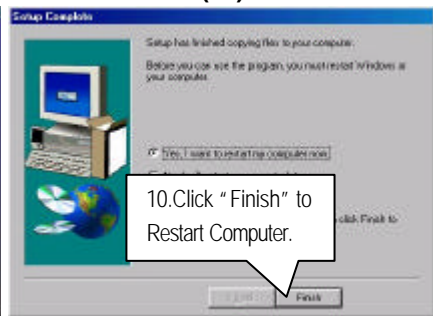

(12)

B. Hardware Monitor:

Insert the support CD that came with your motherboard into your CD-ROM driver or double-click the CD driver icon in My Computer to bring up the screen.

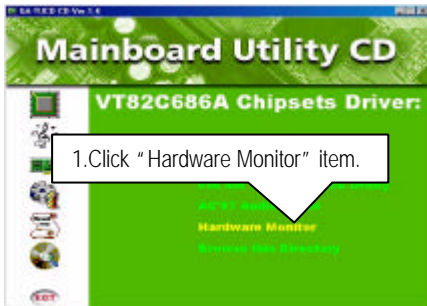

(1)

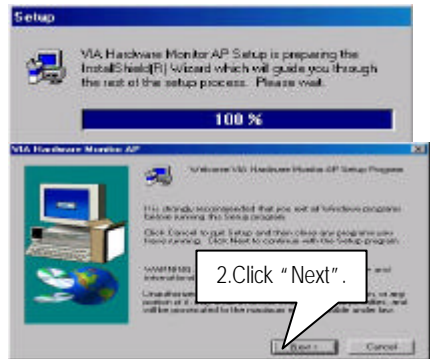

(2)

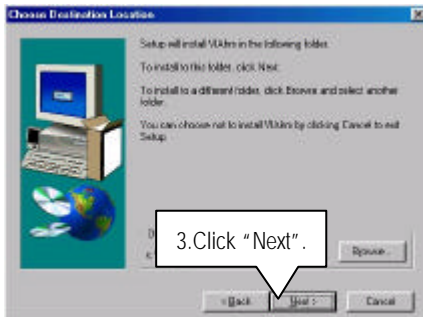

(3)

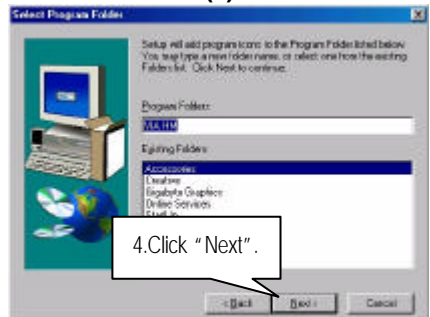

(4)

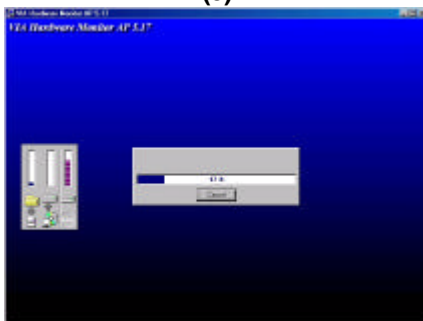

(5)

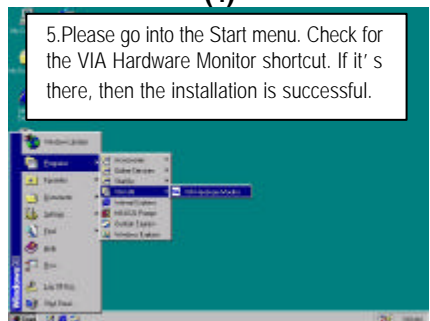

(6)

Appendix B: Creative Sound Driver Installation

Insert the support CD that came with your motherboard into your CD-ROM driver or double-click the CD driver icon in My Computer to bring up the screen.

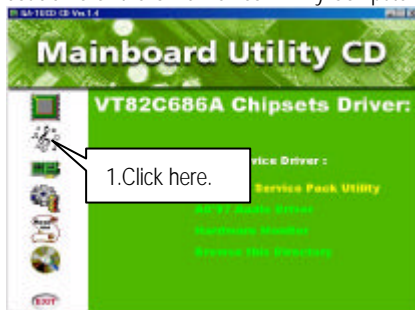

(1)



(2)



(3)

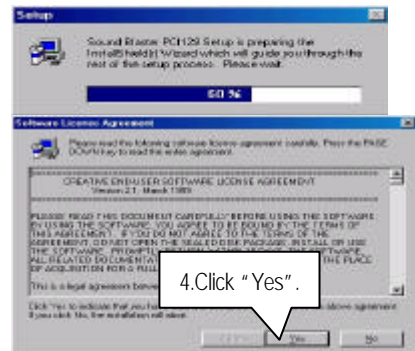

(4)

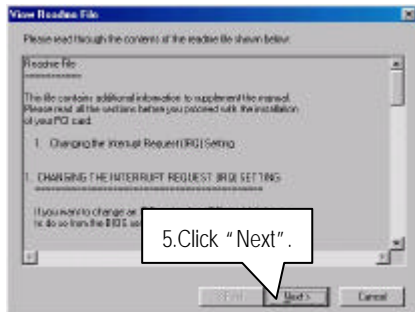

(5)

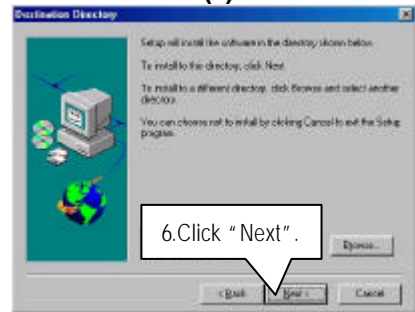

(6)

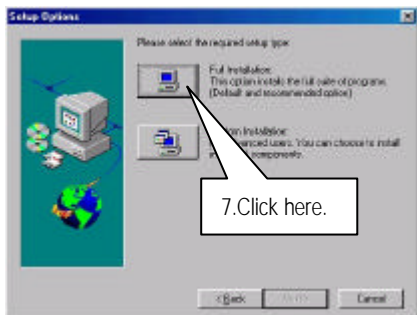

(7)



(8)

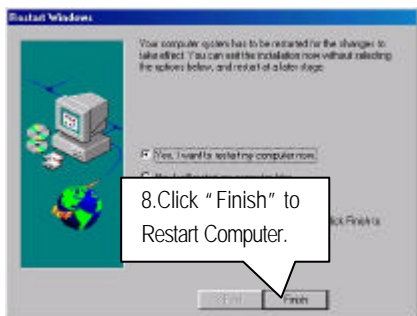

(9)

Appendix C: BIOS Flash Procedure

BIOS update procedure:

- ✓ Please check your BIOS vendor (AMI or AWARD) on the motherboard.
- ✓ It is recommended you copy the AWDFlash.exe or AMIFlash.exe in driver CD (D:\>Utility\BIOSFlash) and the BIOS binary files into the directory you made in your hard disk. 【i.e.:C:\>Utility\ (C:\>Utility : denotes the driver and the directory where you put the flash utilities and BIOS file in.)】
- ✓ Restart your computer into MS-DOS mode or command prompt only for Win95/98, go into the directory where the new BIOS file are located use the utility AWDFlash.exe or AMIFlash.exe to update the BIOS.
- ✓ Type the following command once you have enter the directory where all the files are located C:\utility\ AWDFlash or AMIFlash <filename of the BIOS binary file intended for flashing>
- ✓ Once the process is finished, reboot the system

●[※]Note: Please download the newest BIOS from our website (www.gigabyte.com.tw) or contact your local dealer for the file.

Appendix D: Issues To Beware Of When Installing AMR

Please use inverse AMR card like the one in order to avoid mechanical problem. (See Figure A)

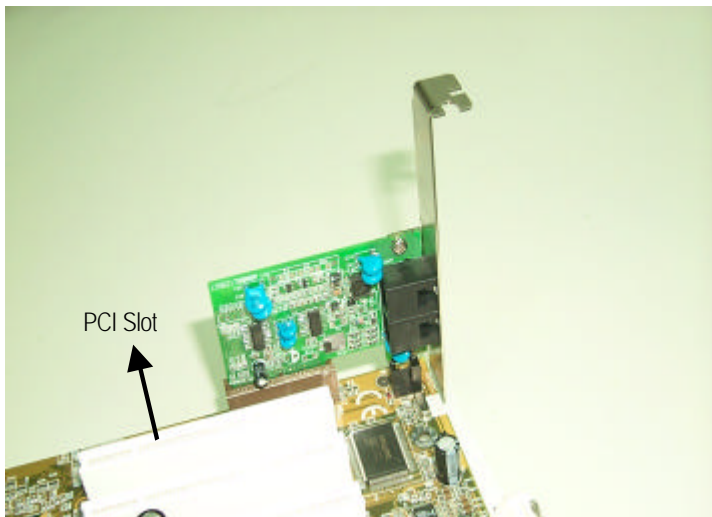

Figure A: Inverse AMR Card (Default)

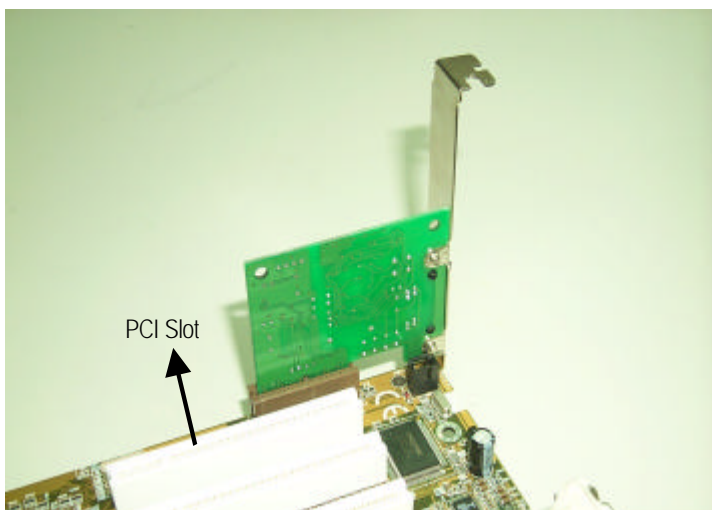

Figure B: Non inverse AMR Card

Appendix E: Acronyms

Acor.	Meaning
ACPI	Advanced Configuration and Power Interface
POST	Power-On Self Test
LAN	Local Area Network
ECP	Extended Capabilities Port
APM	Advanced Power Management
DMA	Direct Memory Access
MHz	Megahertz
ESCD	Extended System Configuration Data
CPU	Central Processing Unit
SMP	Symmetric Multi-Processing
USB	Universal Serial Bus
OS	Operating System
ECC	Error Checking and Correcting
IDE	Integrated Dual Channel Enhanced
SCI	Special Circumstance Instructions
LBA	Logical Block Addressing
EMC	Electromagnetic Compatibility
BIOS	Basic Input / Output System
SMI	System Management Interrupt
IRO	Interrupt Request
NIC	Network Interface Card
A.G.P.	Accelerated Graphics Port
S.E.C.C.	Single Edge Contact Cartridge
LED	Light Emitting Diode
EPP	Enhanced Parallel Port
CMOS	Complementary Metal Oxide Semiconductor
I/O	Input / Output
ESD	Electrostatic Discharge
OEM	Original Equipment Manufacturer
SRAM	Static Random Access Memory
VID	Voltage ID
DMI	Desktop Management Interface
MIDI	Musical Interface Digital Interface
IOAPIC	Input Output Advanced Programmable Input Controller
DIMM	Dual Inline Memory Module
DRAM	Dynamic Random Access Memory
PAC	PCI A.G.P. Controller
AMR	Audio Modem Riser

To be continued...

6VM7-4X Motherboard

Acor.	Meaning
PCI	Peripheral Component Interconnect
RIMM	Rambus in-line Memory Module
DRM	Dual Retention Mechanism
ISA	Industry Standard Architecture
MTH	Memory Translator Hub
CRIMM	Continuity RIMM