

FCC Compliance Statement:

<p style="text-align: center;">DECLARATION OF CONFORMITY Per FCC Part 2 Section 2.107(a)</p> <p style="text-align: center;">FC</p> <p>Responsible Party Name: G.B.T. INC.</p> <p style="text-align: center;">Address: 18365 Valley Blvd., Suite#A LA Puente, CA 91744</p> <p style="text-align: center;">Phone/Fax No: (818) 854-9338 / (818) 854-9339</p> <p>hereby declares that the product</p> <p style="text-align: center;">Product Name: Mother Board</p> <p style="text-align: center;">Model Number: GA-6VMM(-P)</p> <p>Conforms to the following specifications:</p> <p style="text-align: center;">FCC Part 15, Subpart B, Section 15.107(a) and Section 15.109(a), Class B Digital Device.</p> <p>Supplementary Information:</p> <p style="text-align: center;">This device complies with part 15 of the FCC Rules. Operation is subject to the following two conditions: (1) This device may not cause harmful and (2) this device must accept any interference received, including that may cause undesired operation.</p> <p>Representative Person's Name: <u>ERIC LI</u></p> <p>Signature: <u>Eric Lu</u></p> <p>Date: <u>May 1, 2001</u></p>
--

This equipment has been tested and found to comply with limits for a Class B digital device , pursuant to Part 15 of the FCC rules. These limits are designed to provide reasonable protection against harmful interference in residential installations. This equipment generates, uses, and can radiate radio frequency energy, and if not installed and used in accordance with the instructions, may cause harmful interference to radio communications. However, there is no guarantee that interference will not occur in a particular installation. If this equipment does cause interference to radio or television equipment reception, which can be

determined by turning the equipment off and on, the user is encouraged to try to correct the interference by one or more of the following measures:

- Reorient or relocate the receiving antenna
- Move the equipment away from the receiver
- Plug the equipment into an outlet on a circuit different from that to which the receiver is connected
- Consult the dealer or an experienced radio/television technician for additional suggestions

You are cautioned that any change or modifications to the equipment not expressly approve by the party responsible for compliance could void Your authority to operate such equipment.

This device complies with Part 15 of the FCC Rules. Operation is subjected to the following two conditions 1) this device may not cause harmful interference and 2) this device must accept any interference received, including interference that may cause undesired operation.

Declaration of Conformity

We, Manufacturer/Importer
(full address)

G.B.T. Technology Trading GmbH
Ausschlagler Weg 41, 1F, 20537 Hamburg, Germany

declare that the product
(description of the apparatus, system, installation to which it refers)

Mother Board
GA-6VMM(-P)

is in conformity with
(reference to the specification under which conformity is declared)
in accordance with 89/336 EEC-EMC Directive

- | | | | |
|---|--|--|--|
| <input type="checkbox"/> EN 55011 | Limits and methods of measurement of radio disturbance characteristics of industrial, scientific and medical (ISM high frequency equipment | <input type="checkbox"/> EN 61000-3-2*
<input checked="" type="checkbox"/> EN60555-2 | Disturbances in supply systems caused by household appliances and similar electrical equipment "Harmonics" |
| <input type="checkbox"/> EN55013 | Limits and methods of measurement of radio disturbance characteristics of broadcast receivers and associated equipment | <input type="checkbox"/> EN61000-3-3*
<input checked="" type="checkbox"/> EN60555-3 | Disturbances in supply systems caused by household appliances and similar electrical equipment "Voltage fluctuations" |
| <input type="checkbox"/> EN 55014 | Limits and methods of measurement of radio disturbance characteristics of household electrical appliances, portable tools and similar electrical apparatus | <input checked="" type="checkbox"/> EN 50081-1
<input checked="" type="checkbox"/> EN 50082-1 | Generic emission standard Part 1: Residual, commercial and light industry
Generic immunity standard Part 1: Residual, commercial and light industry |
| <input type="checkbox"/> EN 55015 | Limits and methods of measurement of radio disturbance characteristics of fluorescent lamps and luminaries | <input type="checkbox"/> EN 55081-2 | Generic emission standard Part 2: Industrial environment |
| <input type="checkbox"/> EN 55020 | Immunity from radio interference of broadcast receivers and associated equipment | <input type="checkbox"/> EN 55082-2 | Generic immunity standard Part 2: Industrial environment |
| <input checked="" type="checkbox"/> EN 55022 | Limits and methods of measurement of radio disturbance characteristics of information technology equipment | <input type="checkbox"/> ENV 55104 | Immunity requirements for household appliances tools and similar apparatus |
| <input type="checkbox"/> DIN VDE 0855
<input type="checkbox"/> part 10
<input type="checkbox"/> part 12 | Cabled distribution systems; Equipment for receiving and/or distribution from sound and television signals | <input type="checkbox"/> EN 50091- 2 | EMC requirements for uninterruptible power systems (UPS) |

CE marking



(EC conformity marking)

The manufacturer also declares the conformity of above mentioned product with the actual required safety standards in accordance with LVD 73/23 EEC

- | | | | |
|-----------------------------------|---|-------------------------------------|---|
| <input type="checkbox"/> EN 60065 | Safety requirements for mains operated electronic and related apparatus for household and similar general use | <input type="checkbox"/> EN 60950 | Safety for information technology equipment including electrical business equipment |
| <input type="checkbox"/> EN 60335 | Safety of household and similar electrical appliances | <input type="checkbox"/> EN 50091-1 | General and Safety requirements for uninterruptible power systems (UPS) |

Manufacturer/Importer

Signature : Rex Lin
Name : Rex Lin

(Stamp)

Date : May. 1, 2001

6VMM(-P)
Socket 370 Processor Motherboard

USER'S MANUAL

Socket 370 Processor Motherboard
REV. 5.0 Second Edition
R-50-02-010627
12ME-6VMMP-5002

How This Manual Is Organized

This manual is divided into the following sections:

1) Revision History	Manual revision information
2) Item Checklist	Product item list
3) Features	Product information & specification
4) Hardware Setup	Instructions on setting up the motherboard
5) Performance & Block Diagram	Product performance & block diagram
6) Suspend to RAM	Instructions STR installation
7) @BIOS™ & EasyTuneIII™	@BIOS™ & EasyTuneIII™ introduction
8) BIOS Setup	Instructions on setting up the BIOS software
9) Appendix	General reference

Table Of Content

Revision History	P.1
Item Checklist	P.2
Summary of Features	P.3
6VMM(-P) Motherboard Layout	P.5
Installation Guide	P. 6
Page Index for CPU Speed Setup / Connectors / Panel and Jumper Definition	P.11
Performance List	P.35
Block Diagram	P.38
Suspend to RAM Installation	P.39
@BIOS™ Introduction (Optional)	P.45
EasyTuneIII™ Introduction (Optional)	P.46
Memory Installation	P.48
Page Index for BIOS Setup	P.49
Appendix	P.76

Revision History

Revision	Revision Note	Date
5.0	Initial release of the 6VMM(-P) motherboard user's manual.	Apr.2001
5.0	Second release of the 6VMM(-P) motherboard user's manual.	Jun.2001

The author assumes no responsibility for any errors or omissions that may appear in this document nor does the author make a commitment to update the information contained herein. Third-party brands and names are the property of their respective owners.

Item Checklist

- The 6VMM(-P) motherboard
- Cable for IDE / floppy device
- Diskettes or CD (TUCD) for motherboard driver & utility
- 6VMM(-P) user's manual
- Internal COM B Cable (Optional)

Summary Of Features

Form Factor	<ul style="list-style-type: none"> 20.6 cm x 24.4 cm Micro ATX size form factor, 4 layers PCB.
CPU	<ul style="list-style-type: none"> Socket 370 processor <ul style="list-style-type: none"> Intel Pentium® !!!100/133MHz FSB, FC-PGA Intel Celeron™ 66MHz FSB, FC-PGA VIA Cyrix® III 100/133MHz FSB, CPGA 2nd cache in CPU (Depend on CPU)
Chipset	<ul style="list-style-type: none"> VT8601A (Pro Media) VT82C686B
Clock Generator	<ul style="list-style-type: none"> ICS 9248DF-39 66/100/133 MHz system bus speeds (PCI 33MHz) 75/83/112/124/140/150 MHz system bus speeds (reserved)
Memory	<ul style="list-style-type: none"> 2 168-pin DIMM sockets. Supports PC-100 / PC-133 SDRAM and VCM SDRAM Supports up to 1.0GB DRAM Supports only 3.3V SDRAM DIMM
I/O Control	<ul style="list-style-type: none"> VT82C686B
Slots	<ul style="list-style-type: none"> 3 PCI slot supports 33MHz & PCI 2.2 compliant 1 ISA slot 1 AMR(Audio Modem Riser) slot
On-Board IDE	<ul style="list-style-type: none"> 2 IDE bus master (DMA 33/ ATA 66 / ATA100)IDE ports for up to 4 ATAPI devices Supports PIO mode 3, 4 (UDMA 33/ATA 66/ATA100) IDE & ATAPI CD-ROM
On-Board Peripherals	<ul style="list-style-type: none"> 1 floppy port supports 2 FDD with 360K, 720K, 1.2M, 1.44M and 2.88M bytes 1 parallel ports supports SPP/EPP/ECP mode 2 serial ports (COM A & COMB) 4 USB ports 1 IrDA connector for IR
Hardware Monitor	<ul style="list-style-type: none"> CPU / System fan revolution detect CPU / System temperature detect System voltage detect (Vcore,Vcc3,Vcc,+12V)
PS/2 Connector	<ul style="list-style-type: none"> PS/2[®] Keyboard interface and PS/2[®] Mouse interface
BIOS	<ul style="list-style-type: none"> Licensed AMI BIOS, 2M bit flash ROM

To be continued...

Summary of Features

On-Board VGA	<ul style="list-style-type: none">• Build Trident Blade 3D/Pro Media in VT8601A• Support shared Memory Architecture
Additional Features	<ul style="list-style-type: none">• Supports Wake-on-LAN (WOL)• Supports Internal / External modem wake up• Supports USB K/B or Mouse wake up from S3• Includes 3 fan power connectors.• Poly fuse for keyboard over-current protection• Support STR (Suspend-To-RAM) function• Support @BIOS™ and EasyTuneIII™ (Optional)

6VMM(-P) Motherboard Layout

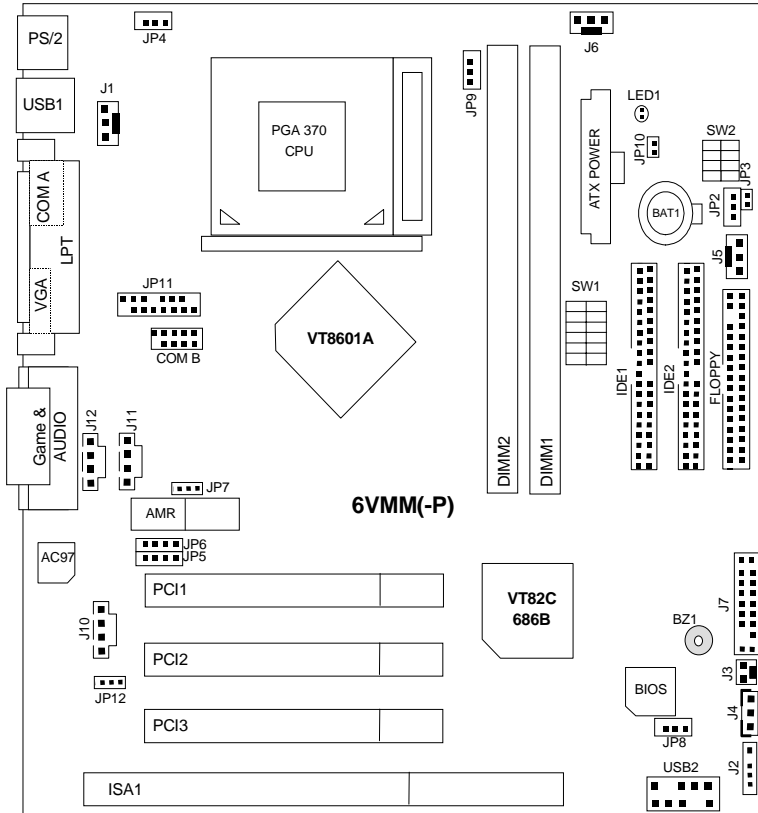

Installation Guide

Getting Started



WARNING!

Computer motherboards and expansion cards contain very delicate Integrated Circuit (IC) chips. To protect them against damage from static electricity, you should follow some precautions whenever you work on your computer.

1. Unplug your computer when working on the inside.
2. Use a grounded wrist strap before handling computer components. If you do not have one, touch both of your hands to a safely grounded object or to a metal object, such as the power supply case.
3. Hold components by the edges and try not touch the IC chips, leads or connectors, or other components.
4. Place components on a grounded antistatic pad or on the bag that came with the components whenever the components are separated from the system.
5. Ensure that the ATX power supply is switched off before you plug in or remove the ATX power connector on the motherboard.

Installing the motherboard to the chassis...

If the motherboard has mounting holes, but they don't line up with the holes on the base and there are no slots to attach the spacers, do not become alarmed you can still attach the spacers to the mounting holes. Just cut the bottom portion of the spacers (the spacer may be a little hard to cut off, so be careful of your hands). In this way you can still attach the motherboard to the base without worrying about short circuits. Sometimes you may need to use the plastic springs to isolate the screw from the motherboard PCB surface, because the circuit wire may be near by the hole. Be careful, don't let the screw contact any printed circuit write or parts on the PCB that are near the fixing hole, otherwise it may damage the board or cause board malfunctioning.

6VMM(-P) Motherboard

To set up your computer, you must complete the following steps:

- ▶ Step 1 - Set system jumpers
- ▶ Step 2- Install the Central Processing Unit (CPU)
- ▶ Step 3-Install memory modules
- ▶ Step 4-Install expansion cards
- ▶ Step 5-Connect ribbon cables, cabinet wires, and power supply
- ▶ Step 6-Set up BIOS software
- ▶ Step 7-Install supporting software tools

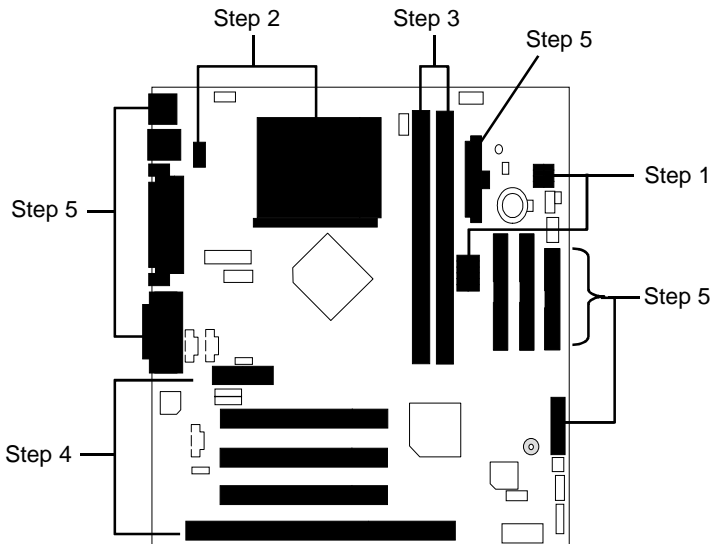

CPU Installation

Please make sure the CPU type and speed is supported by your motherboard.



CPU Top View

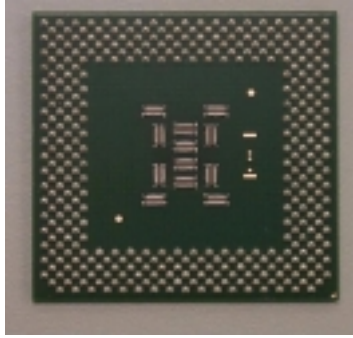

CPU Bottom View

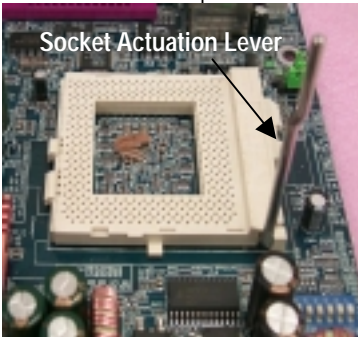

1. Pull the lever out and lift it up.

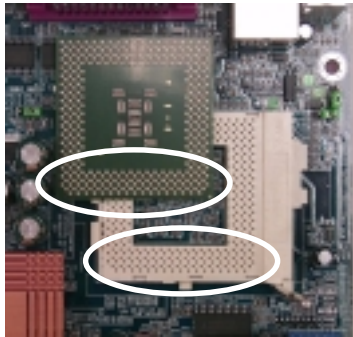

2. The notched corner should point toward the end of the lever. The CPU will only fit in the orientation as shown.

 CPU Heat Sink Installation:

Beware: Please check that the heat sink is in good contact with the CPU before you turn on your system. **Poor contact will cause over heat with might cause damage to your processor!**



3. Align CPU and insert it

(Please refer to your heatsink installation manual for application of thermal grease to provide better heat conduction between your CPU and heatsink.)



4. Use compliant fan approved by Intel.

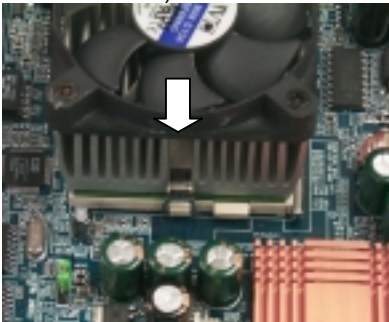

5. Hook one end of the cooler bracket to the CPU socket.

6. Hook the other end of the cooler bracket to the CPU socket.

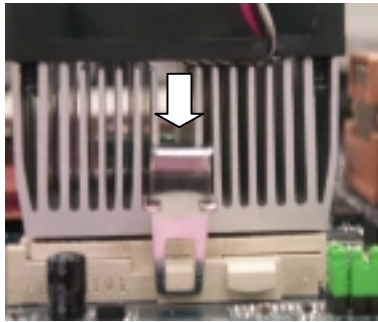

 (Please refer to the cooler's installation manual for detailed installation steps)

Memory Installation

The motherboard has 2 dual inline memory module (DIMM) sockets support 4 banks. The BIOS will automatically detects memory type and size. To install the memory module, just push it vertically into the DIMM Slot .The DIMM module can only fit in one direction due to the two notch. Memory size can vary between sockets.

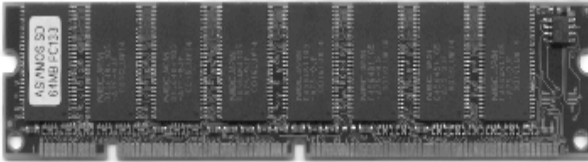

SDRAM

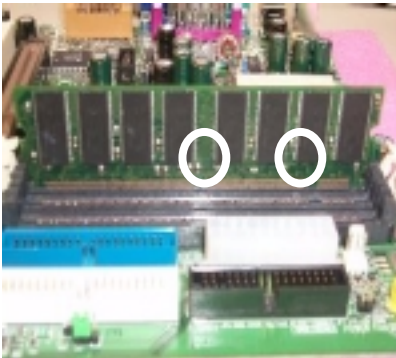

1. The DIMM slot has two notch, so the DIMM memory module can only fit in one direction.
 2. Insert the DIMM memory module vertically into the DIMM slot. Then push it down.
 3. Close the plastic clip at both edges of the DIMM slots to lock the DIMM module.
-  Reverse the installation steps when you wish to remove the DIMM module.

 Page Index for CPU Speed Setup / Connectors / Panel and Jumper Definition	Page
CPU Speed Setup	P.12
Connectors	P.20
ATX Power	P.20
COM A / VGA / LPT Port	P.20
COM B Port	P.21
CN1(PS/2 Keyboard & PS/2 Mouse Connector)	P.21
USB 1 Connector	P.22
USB 2 Connector	P.22
Floppy Port	P.23
Game & Audio Port	P.23
IDE 1 (Primary)/ IDE 2(Secondary) Port	P.24
J1 (CPU Fan)	P.24
J2 (IR)	P.25
J3 (Internal Modem Card Ring On)	P.25
J4 (Wake On LAN)	P.26
J5 (System Fan)	P.26
J6 (Power Fan)	P.27
J10 (TEL)	P.27
JP10 / LED1(STR LED Connector & DIMM LED)	P.28
J11 (AUX_IN)	P.28
JP11 (Front Audio)	P.29
J12 (CD Audio Line In)	P.29
Panel and Jumper Definition	P.30
J7 (2x11 Pins Jumper)	P.30
JP2 (Clear CMOS Function)	P.31
JP3 (Case Open)	P.31
JP4 (USB Device Wake Up Selection)	P.32
JP5/JP6/JP7 (Onboard AC97& AMR Select)	P.32
JP8 (BIOS Write Protection)	P.33
JP9 (STR Function Enabled)	P.33
JP12 (Front MIC)	P.34
BAT1 (Battery)	P.34

CPU Speed Setup

The system bus speed is selectable at 66,100,133MHz and Auto. The user can select the system bus speed (**SW1**) and change the DIP switch (**SW2**) selection to set up the CPU speed for 300 – 1GB processor.

Set System Bus Speed

SW1:

O : ON, X : OFF

CPU (MHz)	1	2	3	4	5	6	PCI(MHz)
Auto	X	X	X	X	O	O	33.3
66	O	O	X	X	X	X	33.3
75	O	O	O	X	X	X	37.5
83	O	O	X	O	X	X	41.6
100	O	X	X	X	X	X	33.3
112	O	X	O	X	X	X	37.3
124	X	X	X	O	X	X	31
133	X	X	X	X	X	X	33.3
140	X	X	O	O	X	X	35
150	X	X	O	X	X	X	37.5

The CPU speed must match with the frequency ratio. It will cause system hanging up if the frequency ratio is higher than that of CPU.

SW2:

FREQ. RATIO	DIP SWITCH			
	1	2	3	4
X3	O	X	O	O
X3.5	X	X	O	O
X4	O	O	X	O
X4.5	X	O	X	O
X5	O	X	X	O
X5.5	X	X	X	O
X6	O	O	O	X
X6.5	X	O	O	X
X7	O	X	O	X
X7.5	X	X	O	X
X8	O	O	X	X
X8.5	O	X	O	O
X9	X	X	O	O
X9.5	X	O	O	O
X10	X	O	X	X
X10.5	O	O	X	O
X11	O	X	X	X
X11.5	X	O	X	O
X12	O	X	X	O

6VMM(-P) Motherboard

X13	X	X	X	O
X14	O	O	O	X
X15	X	O	O	X
X16	O	X	O	X

☛ For Auto Jumper Setting:

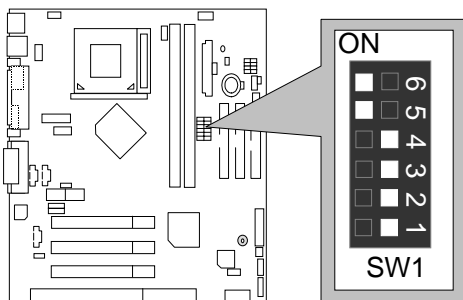

★Note:

1. If you use 66/100/133 MHz CPU, We recommend you to setup your system speed to "Auto" value.
 2. We don't recommend you to set up your system speed to 75 , 83 , 112 , 124 , 140 ,150 MHz because these frequencies are not the standard specifications for CPU, Chipset and most of the peripherals. Whether your system can run under 75 , 83 ,112 ,124 ,140 ,150 MHz properly will depend on your hardware configurations: CPU, SDRAM, Cards, etc.
1. Celeron™ 300A/ 66 MHz FSB

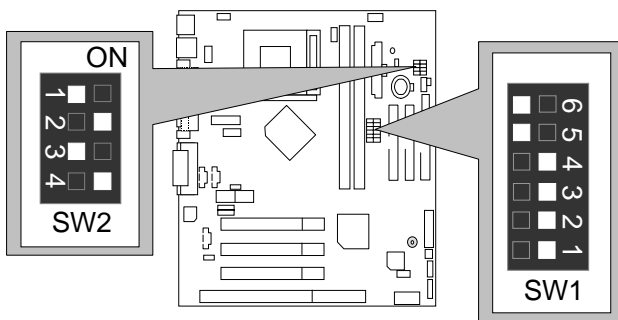

2. Celeron™ 333/ 66 MHz FSB

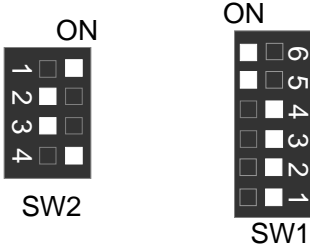

3. Celeron™ 366/ 66 MHz FSB

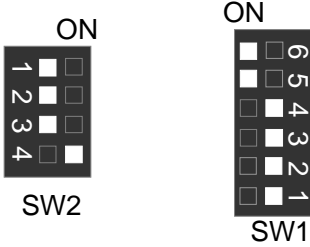

4. Celeron™ 400/ 66 MHz FSB

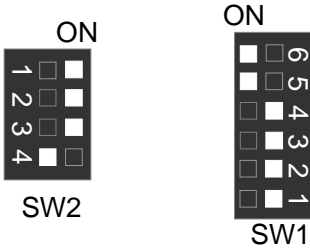

5. Celeron™ 433/ 66 MHz FSB

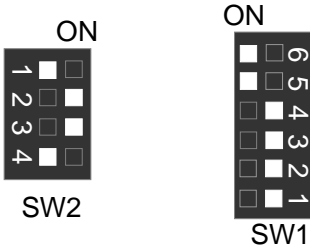

6. Celeron™ 466/ 66 MHz FSB

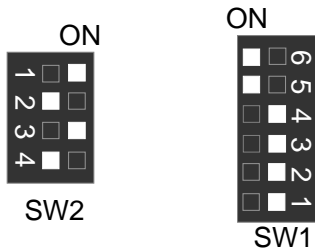

7. Celeron™ 500/ 66 MHz FSB

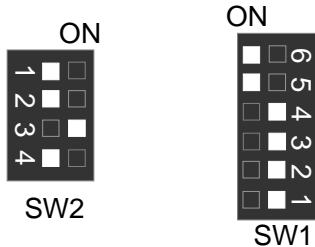

8. Celeron™ 533/ 66 MHz FSB

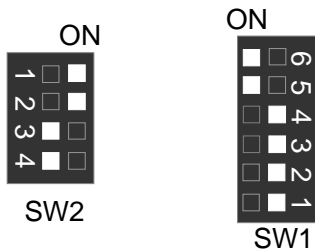

9. Celeron™ 566/ 66 MHz FSB

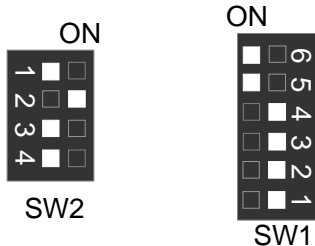

10. Pentium® !!! 500/100MHz FSB

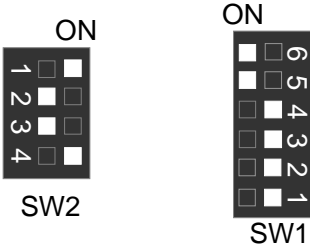

11. Pentium® !!! 550/100MHz FSB

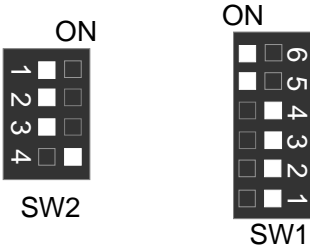

12. Pentium® !!! 600/100MHz FSB

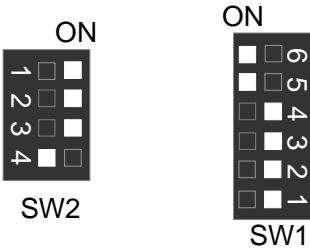

13. Pentium® !!! 650/100MHz FSB

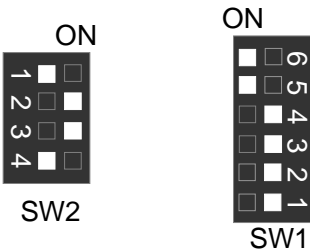

14. Pentium® !!! 700/100MHz FSB

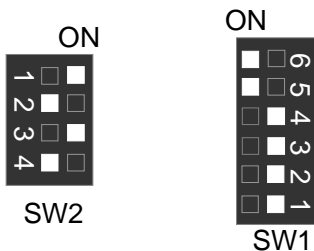

15. Pentium® !!! 750/100MHz FSB

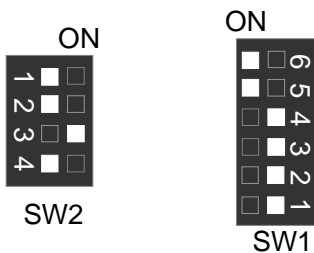

16. Pentium® !!! 800/100MHz FSB

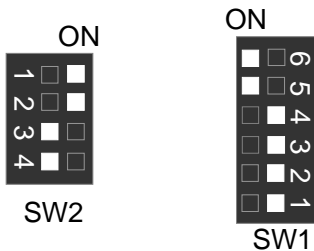

17. Pentium® !!! 850/100MHz FSB

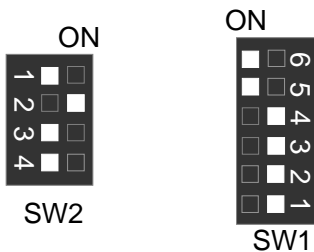

18. Pentium® !!! 533/133MHz FSB

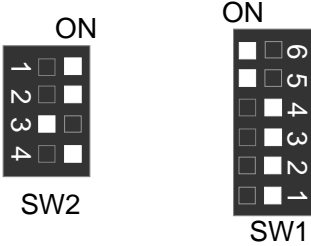

19. Pentium® !!! 600/133 MHz FSB

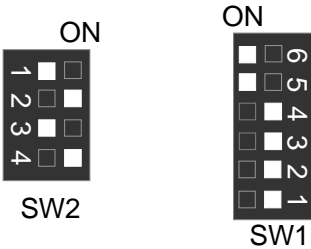

20. Pentium® !!! 667/133MHz FSB

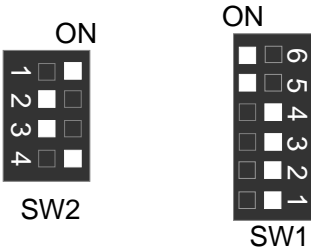

21. Pentium® !!! 733/133MHz FSB

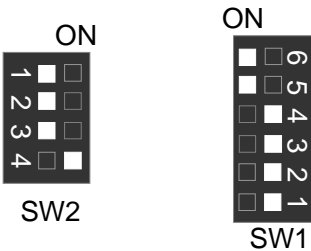

22. Pentium® !!! 800/133MHz FSB

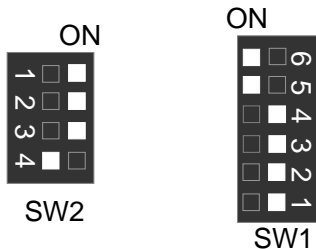

23. Pentium® !!! 866/133MHz FSB

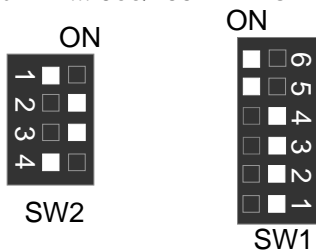

24. Pentium® !!! 933/133MHz FSB

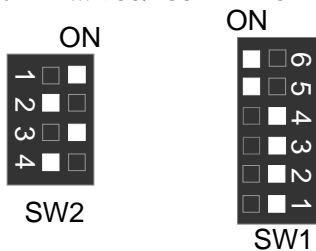

25. Pentium® !!! 1G Hz/133MHz FSB

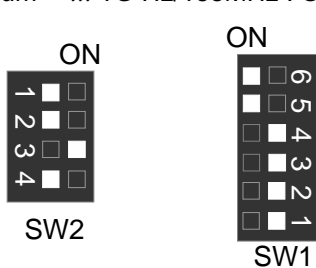

Connectors

ATX Power

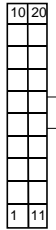
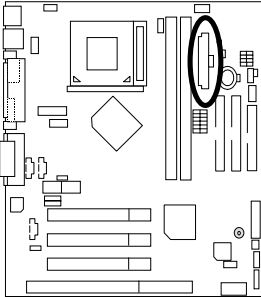

Pin No.	Definition
3,5,7,13, 15-17	GND
1,2,11	3.3V
4,6,19,20	VCC
10	+12V
12	-12V
18	-5V
8	Power Good
9	5V SB stand by+5V
14	PS-ON(Soft On/Off)



Please note:

AC power cord should only be connected to your power supply unit after ATX power cable and other related devices are firmly connected to the mainboard.

COM A / VGA / LPT Port

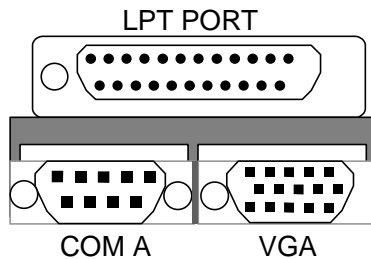
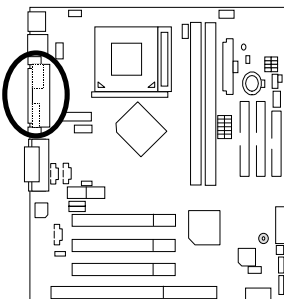

Please note:

This mainboard supports 1 standard COM ports and 1 LPT port. Device like printer can be connected to LPT port ; mouse and modem etc can be connected to COM port.

COM B Port

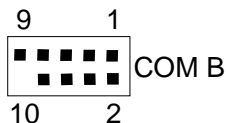
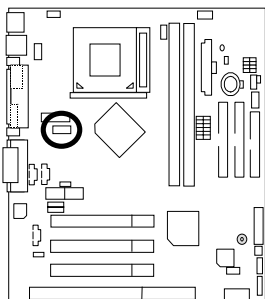

CN1:PS/2 Keyboard & PS/2 Mouse Connector

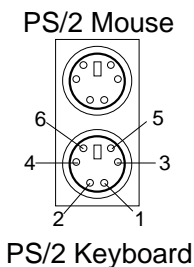
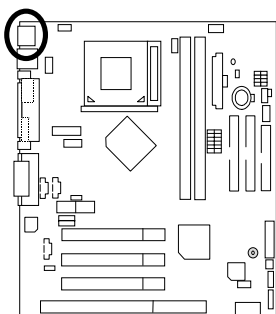

PS/2 Mouse /Keyboard	
Pin No.	Definition
1	Data
2	NC
3	GND
4	Power
5	Clock
6	NC



Please note:

This mainboard supports standard PS/2 keyboard and PS/2 mouse interface connector.

USB1: USB1 Connector

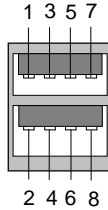
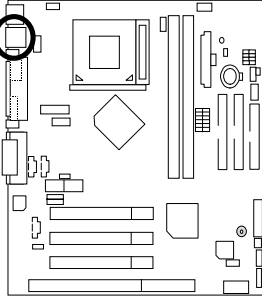

Pin No.	Definition
1	USB PWR
2	USB PWR
3	USB D0-
4	USB DT1-
5	USB D0+
6	USB DT1+
7	GND
8	GND

Please note:

Before you connect your device(s) into USB connector(s), please make sure your device(s) such as USB keyboard, mouse, scanner, zip, buzzer...etc. have a standard USB interface. Also make sure your OS (Win 95 w/ USB supperment, Win98, Windows 2000, Windows ME, Win NT w/ SP 6) supports USB controller. If your OS does not support USB controller, please contact OS venders for possible patch or driver upgrade. For more information please contact your OS or device(s) venders.



USB2: USB 2 Connector

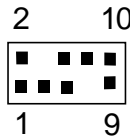
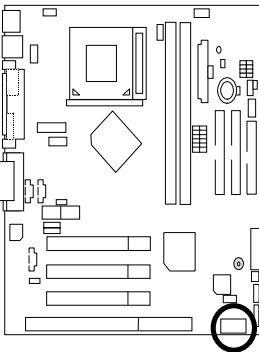

Pin No.	Definition
1	USB PWR
2	GND
3	USB D2-
4	NC
5	USB D2+
6	USB D3+
7	NC
8	USB D3-
9	GND
10	USB PWR

Please Note:

Be careful with the polarity of the front panel USB connector. Check the pin assignment while you connect the front panel USB cable. Please contact your nearest dealer for optional front panel USB cable.



Floppy Port

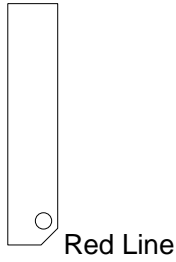
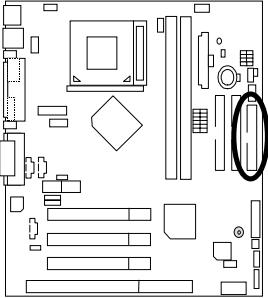

Game & Audio Port

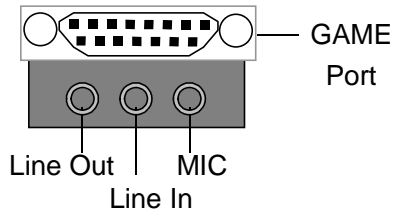
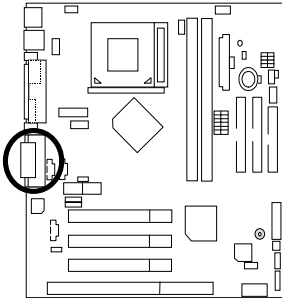

IDE1(Primary), IDE2(Secondary) Port

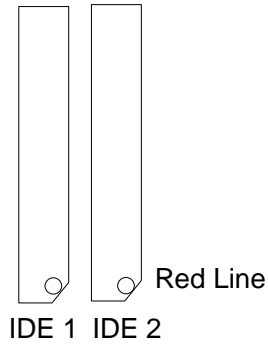
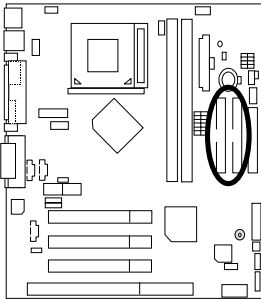

J1: CPU Fan

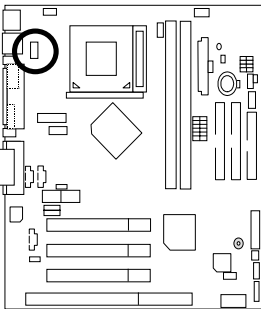

Pin No.	Definition
1	Control
2	+12V
3	SENSE



Please note:

A proper installation of the CPU cooler is essential to prevent the CPU from running under abnormal condition or damaged by overheating.

J2:IR

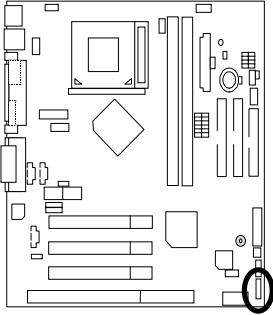

Pin No.	Definition
1	VCC (+5V)
2	NC
3	IR Data Input
4	GND
5	IR Data Output



Please note:

Warning make sure the pin 1 on the IR device is align with pin one the connector.

J3:Internal Modem Card Ring On

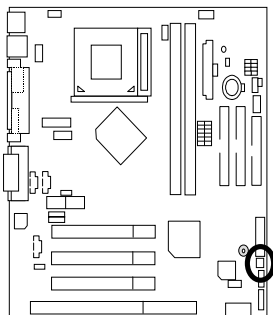

Pin No.	Definition
1	Signal
2	GND

J4: Wake On LAN

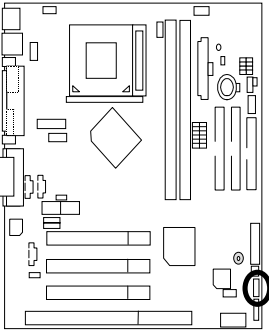

Pin No.	Definition
1	+5V SB
2	GND
3	Signal

J5: System Fan

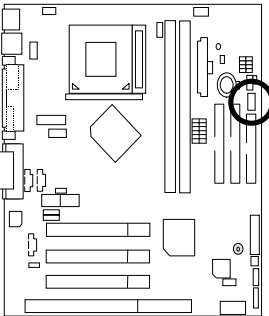

Pin No.	Definition
1	Control
2	+12V
3	SENSE

J6: Power Fan

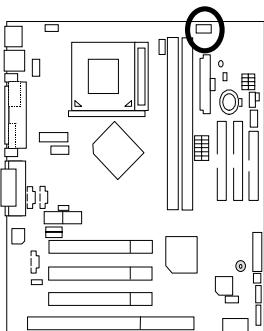

Pin No.	Definition
1	Control
2	+12V
3	NC

J10: TEL(The connector is for Modem with internal voice connector)

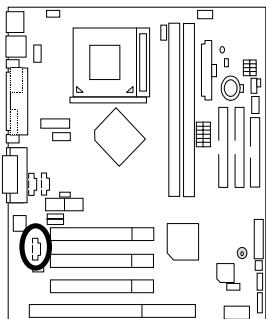

Pin No.	Definition
1	Signal-In
2	GND
3	GND
4	Signal-Out

JP10 / LED1: STR LED Connector & DIMM LED

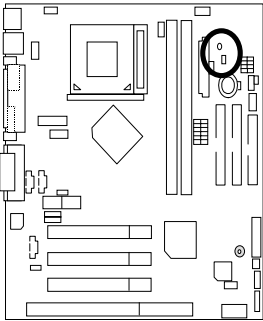

DIMM LED



STR LED Connector External.

**Please note:**

Do not remove memory modules while DIMM LED is on. It might cause short or other unexpected damages due to the 3.3V stand by voltage. Remove memory modules only when STR function is disabled by jumper and AC Power cord is disconnected.

J11:AUX_IN

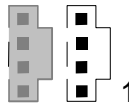
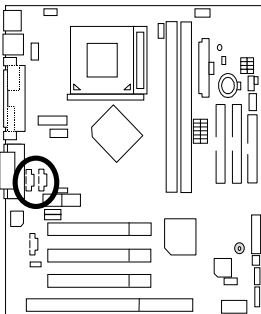

Pin No.	Definition
1	AUX-L
2	GND
3	GND
4	AUX-R

JP11: Front Audio

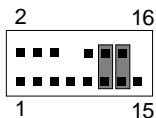
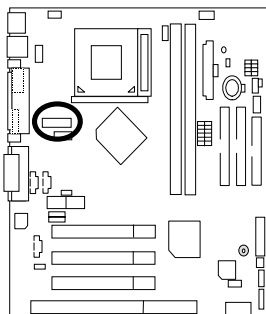

PIN NO.	Definition
1	Incase speaker (R)
2	Incase speaker (L)
3, 4,5,6,10,15	GND
7	+12V
8,16	NC
9	MIC
11	Front Audio (R)
13	Front Audio (L)
12	Rear Audio (R)
14	Rear Audio (L)



Please Note :

If you want to use "Front Audio" connector, you must move 11-12,13-14 Jumper. In order to utilize the front audio header, your chassis must have front audio connector. Also please make sure the pin assignment on the cable is the same as the pin assignment on the MB header. To find out if the chassis you are buying support front audio connector, please contact your dealer.

J12: CD Audio Line In

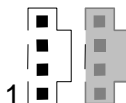
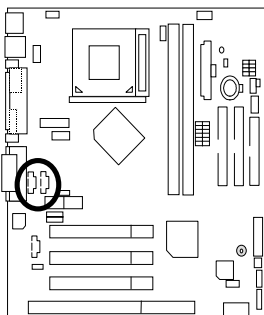

Pin No.	Definition
1	CD-L
2	GND
3	GND
4	CD-R

Panel and Jumper Definition

J7 : 2x11 Pins Jumper

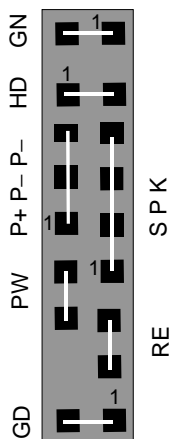
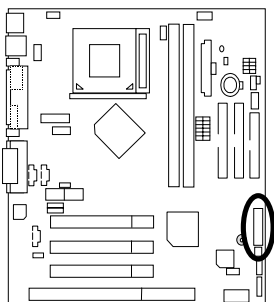

GN (Green Switch)	Open: Normal Operation Close: Entering Green Mode
GD (Green LED)	Pin 1: LED anode(+) Pin 2: LED cathode(-)
HD (IDE Hard Disk Active LED)	Pin 1: LED anode(+) Pin 2: LED cathode(-)
SPK (Speaker Connector)	Pin 1: VCC(+) Pin 2- Pin 3: NC Pin 4: Data(-)
RE (Reset Switch)	Open: Normal Operation Close: Reset Hardware System
P+P-P-(Power LED)	Pin 1: LED anode(+) Pin 2: LED cathode(-) Pin 3: LED cathode(-)
PW (Soft Power Connector)	Open: Normal Operation Close: Power On/Off



Please note:

Please connect the power LED, PC speaker, reset switch and power switch etc of your chassis front panel to the front panel jumper according to the pin assignment above.

JP2 : Clear CMOS Function

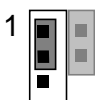
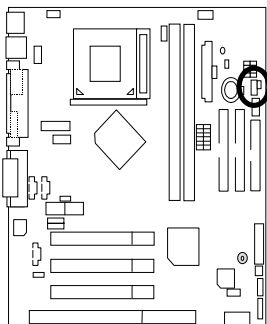

**Normal
(Default)**

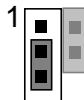

Clear CMOS

Pin No.	Definition
1-2 Close	Normal (Default)
2-3 Close	Clear CMOS



Please note:

You may clear the CMOS data to its default values by this jumper.

JP3 : Case Open

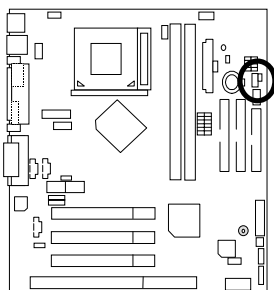

Pin No.	Definition
1	Signal
2	GND

JP4: USB Device Wake up Selection

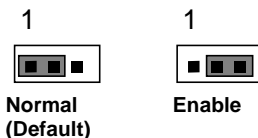
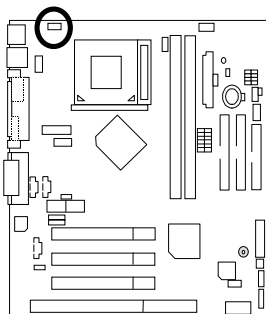

Pin No.	Definition
1-2 close	Normal (Default)
2-3 close	USB Wake Up



Please Note: (If you want to use "USB KB/MS Wake up from S3" function, you have to set the BIOS setting "USB KB/MS Wake up from S3" enabled, and the jumper "JP4 & JP9" enabled).

*(Power on the computer and as soon as memory counting starts, press . You will enter BIOS Setup. Select the item "POWER MANAGEMENT SETUP", then select "USB KB/MS Wake up from S3". Remember to save the setting by pressing "ESC" and choose the "SAVE & EXIT SETUP" option.)

JP5/JP6/JP7 : Onboard AC97& AMR (Primary or Secondary) Select (AMR→ Audio Modem Riser)

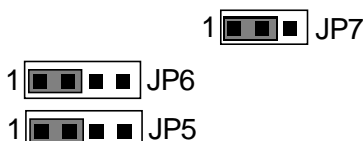
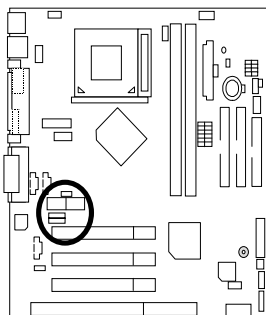

Jumper Function	JP5	JP6	JP7
Only AC97 (Default)	1-2	1-2	1-2
Only AMR (Primary)	3-4	3-4	2-3
AC97+MR (Secondary)	1-2 3-4	1-2	1-2



Please note:

JP7: 1-2 close: If you use software audio(onboard CODEC only), your modem riser must be "Secondary". JP7: 2-3 close: If you don't use onboard software audio, your audio/modem riser must be "Primary". Mainboard's software audio will be disabled. There are two types of AMR/MR card in the market, Primary and secondary. If your AMR/MR card is primary, JP7 should be set to 2-3, if you have secondary AMR/MR card JP7 should be set to 1-2. Warning! If Primary AMR/RM card is used, on-board audio will be disabled.

JP8 : BIOS Write Protection

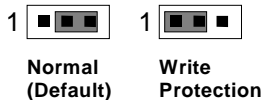
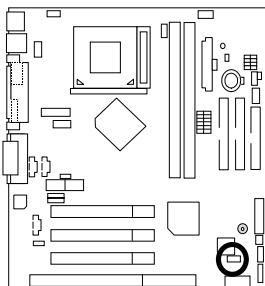

Pin No.	Definition
1-2close	Write Protection
2-3close	Normal (Default)



Please note: To flash/upgrade BIOS on this MB JP8 must be opened. We recommend JP8 to be set to close, whenever user is not try to flash/upgrade the BIOS.

JP9: STR Function Selection

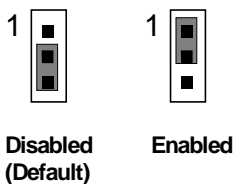
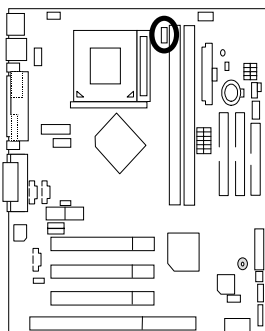

Pin No.	Definition
2-3close	STR Disabled (Default)
1-2close	STR Enabled

JP12 : Front MIC

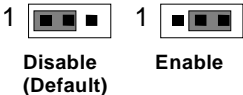
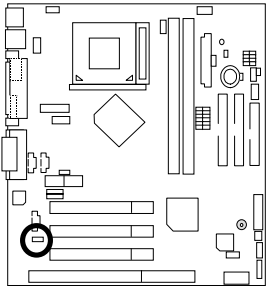

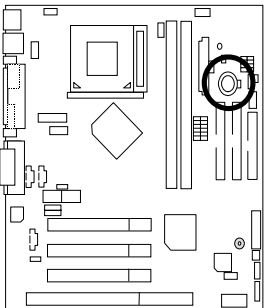

Pin No.	Definition
1-2close	Disable (Default)
2-3close	Enable

BAT1 : Battery



CAUTION

-  Danger of explosion if battery is incorrectly replaced.
-  Replace only with the same or equivalent type recommended by the manufacturer.
-  Dispose of used batteries according to the manufacturer's instructions.

Performance List

The following performance data list is the testing results of some popular benchmark testing programs.

These data are just referred by users, and there is no responsibility for different testing data values gotten by users. (The different Hardware & Software configuration will result in different benchmark testing results.)

- CPU Intel Pentium® III 1G Hz processor
- DRAM (128 x 1)MB SDRAM (Mosel 0015PR V54C365804VCT7)
- CACHE SIZE 256 KB included in CPU
- DISPLAY Onboard VIA VT8601A 0046CD Graphics Controller
- STORAGE Onboard IDE (IBM DTLA-307060)
- O.S. Windows NT™ 4.0 SPK6a
- DRIVER Display Driver at 1024 x 768 65536 colors 75Hz.
VIA Bus Master IDE Driver Ver 2.1.49

Processor	Intel Pentium® III 1G Hz (7.5x133)
Winbench99	
CPU mark 99	78.6
FPU Winmark 99	5320
Business Disk Winmark 99	7980
Hi-End Disk Winmark 99	19700
Business Graphics Winmark 99	219
Hi-End Graphics Winmark 99	680
Winstone99	
Business Winstone 99	42.9
Hi-End Winstone 99	53.5

- CPU Intel Celeron 800MHz processor
- DRAM (128x1)MB SDRAM (Mosel 0015PR V54C365804VCT7)
- CACHE SIZE 66KB included in CPU
- DISPLAY Onboard VIA VT8601A 0046CD Graphics Controller
- STORAGE Onboard IDE (IBM DTLA-307060)
- O.S. Windows NT™ 4.0 SPK6a
- DRIVER Display Driver at 1024 x 768 65536 colors 75Hz.
VIA Bus Master IDE Driver Ver 2.1.49

Processor	Intel Celeron 800MHz (12x66)
Winbench99	
CPU mark 99	51.4
FPU Winmark 99	4280
Business Disk Winmark 99	7380
Hi-End Disk Winmark 99	20000
Business Graphics Winmark 99	177
Hi-End Graphics Winmark 99	516
Winstone99	
Business Winstone 99	34.8
Hi-End Winstone 99	41.3

6VMM(-P) Motherboard

- CPU VIA Cyrix III 600MHz processor
- DRAM (128x1)MB SDRAM (Mosel 0015PR V54C365804VCT7)
- CACHE SIZE 256KB included in CPU
- DISPLAY Onboard VIA VT8601A 0046CD Graphics Controller
- STORAGE Onboard IDE (IBM DTLA-307060)
- O.S. Windows NT™ 4.0 SPK6a
- DRIVER Display Driver at 1024 x 768 65536 colors 75Hz.
VIA Bus Master IDE Driver Ver 2.1.49

Processor	VIA Cyrix III 600MHz (4.5X133)
Winbench99	
CPU mark 99	24.2
FPU Winmark 99	994
Business Disk Winmark 99	6180
Hi-End Disk Winmark 99	17700
Business Graphics Winmark 99	133
Hi-End Graphics Winmark 99	269
Winstone99	
Business Winstone 99	26
Hi-End Winstone 99	18.7

Block Diagram

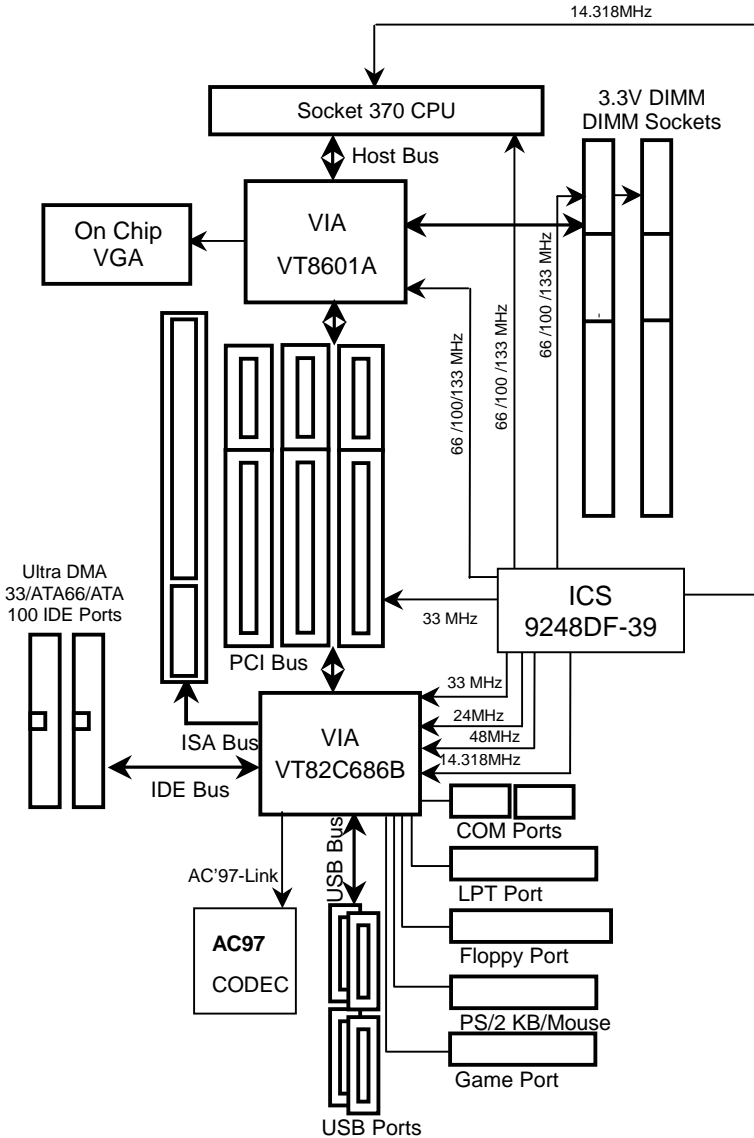

Suspend To RAM Installation

A.1 Introduce STR function:

Suspend-to-RAM (STR) is a Windows 98 ACPI sleep mode function. When recovering from STR (S3) sleep mode, the system is able, in just a few seconds, to retrieve the last "state" of the system before it went to sleep and recover to that state. The "state" is stored in memory (RAM) before the system goes to sleep. During STR sleep mode, your system uses only enough energy to maintain critical information and system functions, primarily the system state and the ability to recognize various "wake up" triggers or signals, respectively.

A.2 STR function Installation

Please use the following steps to complete the STR function installation.

Step-By-Step Setup

Step 1:

To utilize the STR function, the system must be in Windows 98 ACPI mode.

Putting Windows 98 into ACPI mode is fairly easy.

Setup with Windows 98 CD:

- A. Insert the Windows 98 CD into your CD-ROM drive, select Start, and then Run.
- B. Type (without quotes) "**D:\setup** " in the window provided. Hit the enter key or click OK.
- C. After setup completes, remove the CD, and reboot your system
(This manual assumes that your CD-ROM device drive letter is D:).

Step 2:

(If you want to use STR Function, please set jumper JP9 Closed.)

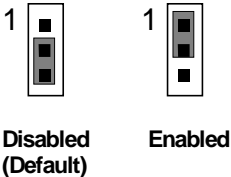
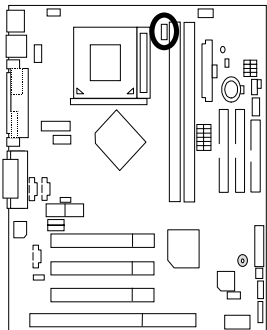

Pin No.	Definition
2-3close	STR Disabled (Default)
1-2close	STR Enabled

Step 3:

Power on the computer and as soon as memory counting starts, press . You will enter BIOS Setup. Select the item **“POWER MANAGEMENT SETUP”**, then select **“ACPI Sleep Type : S3 / STR”**. Remember to save the settings by pressing "ESC" and choose the **“SAVE & EXIT SETUP”** option.

Congratulation! You have completed the installation and now can use the STR function.

A.3 How to put your system into STR mode?

There are two ways to accomplish this:

1. Choose the "Stand by" item in the "Shut Down Windows" area.
 - A. Press the "Start" button and then select "Shut Down"



- B. Choose the "Stand by" item and press "OK"

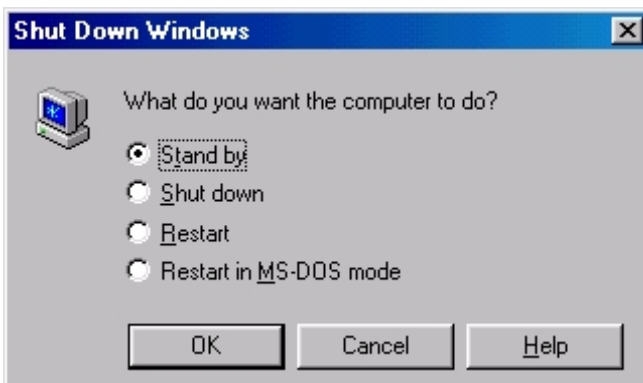

2. Define the system "power on" button to initiate STR sleep mode:

A. Double click "My Computer" and then "Control Panel"

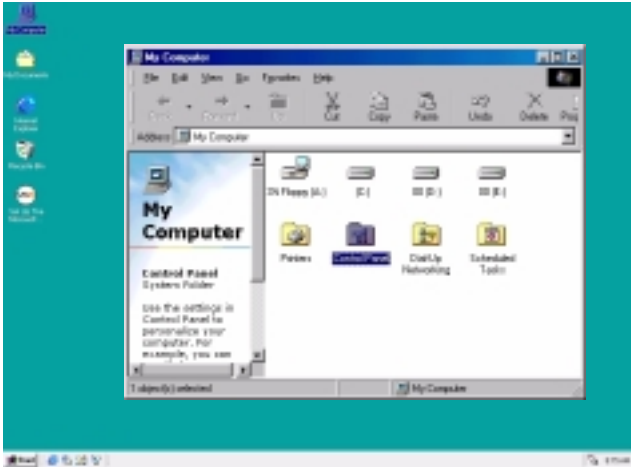

B. Double click the " Power Management" item.

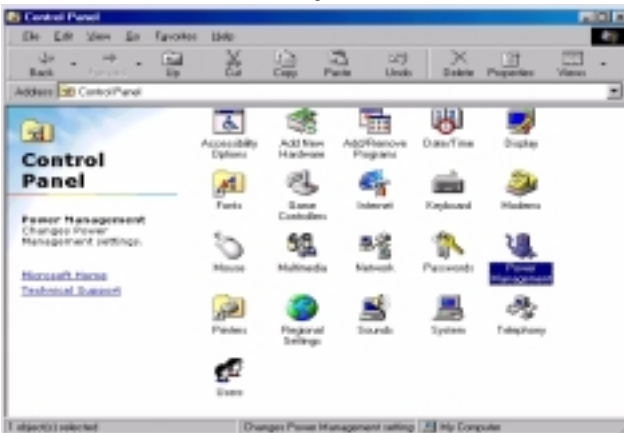

C. Select the "Advanced" tab and "Standby" mode in Power Buttons.



D. Restart your computer to complete setup.

Now when you want to enter STR sleep mode, just momentarily press the "Power on" button.

A.4 How to recover from the STR sleep mode?

There are five ways to "wake up" the system:

1. Press the "Power On" button.
2. Use the "PS/2 Mouse Power On" function.
3. Use the "Resume by Alarm" function.
4. Use the "Modem Ring On" function.
5. Use the "Wake On LAN" function.

A.5 Notices :

1. In order for STR to function properly, several hardware and software requirements must be satisfied:
 - A. Your ATX power supply must comply with the ATX 2.01 specification (provide more than 720 mA 5V Stand-By current).
 - B. Your SDRAM must be PC-100 compliant.
2. Jumper JP10 is provided to connect to the STR LED in your system chassis. [Your chassis may not provide this feature.] The STR LED will be illuminated when your system is in STR sleep mode.

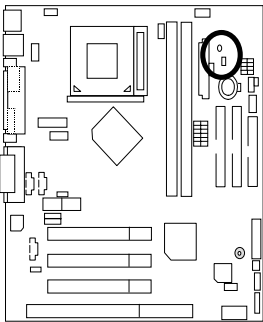

DIMM LED



STR LED Connector External.



@BIOS™ Introduction (Optional)

Gigabyte announces @ BIOS™ Windows BIOS live update utility



Have you ever updated BIOS by yourself? Or like many other people, you just know what BIOS is, but always hesitate to update it? Because you think updating newest BIOS is unnecessary and actually you don't know how to update it.

Maybe not like others, you are very experienced in BIOS updating and spend quite a lot of time to do it. But of course you don't like to do it too much. First, download different BIOS from website and then switch the operating system to DOS mode. Secondly, use different flash utility to update BIOS. The above process is not a interesting job. Besides, always be carefully to store the BIOS source code correctly in your disks as if you update the wrong BIOS, it will be a nightmare.

Certainly, you wonder why motherboard vendors could not just do something right to save your time and effort and save you from the lousy BIOS updating work? Here it comes! Now Gigabyte announces @BIOS™ --the first Windows BIOS live update utility. This is a smart BIOS update software. It could help you to download the BIOS from internet and update it. Not like the other BIOS update software, it's a Windows utility. With the help of "@BIOS™", BIOS updating is no more than a click.

Besides, no matter which mainboard you are using, if it's a Gigabyte's product*, @BIOS™ help you to maintain the BIOS. This utility could detect your correct mainboard model and help you to choose the BIOS accordingly. It then downloads the BIOS from the nearest Gigabyte ftp site automatically. There are several different choices; you could use "Internet Update" to download and update your BIOS directly. Or you may want to keep a backup for your current BIOS, just choose "Save Current BIOS" to save it first. You make a wise choice to use Gigabyte, and @BIOS™ update your BIOS smartly. You are now worry free from updating wrong BIOS, and capable to maintain and manage your BIOS easily. Again, Gigabyte's innovative product erects a milestone in mainboard industries.

For such a wonderful software, how much it costs? Impossible! It's free! Now, if you buy a Gigabyte's motherboard, you could find this amazing software in the attached driver CD. But please remember, connected to internet at first, then you could have a internet BIOS update from your Gigabyte @BIOS™.

EasyTuneIII™ Introduction (Optional)

Gigabyte announces **EasyTuneIII™** Windows overdrive utility



“Overdrive” might be one of the most common issues in computer field. But have many users ever tried it? The answer is probably “no”. Because “overdrive” is thought to be very difficult and includes a lot of technical know-how, sometimes “overdrive” is even considered as special skills found only in some enthusiasts.

But as to the experts in “overdrive”, what’s the truth? They may spend quite a lot of time and money to study, try and use many different hardware and software tools to do “overdrive”. And even with these technologies, they still learn that it’s quite a risk because the safety and stability of an “overdrive” system is unknown.

Now everything is different because of a Windows overdrive utility EasyTuneIII™ --announced by Gigabyte. This utility has totally changed the gaming rule of “overdrive”. This is the first overdrive utility suitable for both normal and power users. Users can choose either “Easy Mode” or “Advanced Mode” to run “overdrive” at their convenience. For users who choose “Easy Mode”, they just need to click “Auto Optimize” to have auto and immediate CPU overclocking. This software will then overdrive CPU speed automatically with the result being shown in the control panel. If someone prefers to “overdrive” by oneself, there is also another choice. Click “Advanced Mode” to enjoy “sport drive” class overclocking. In “Advanced Mode”, one can change the system bus speed in small increments to get ultimate system performance. And no matter which mainboard is used, if it’s a Gigabyte’s product*, EasyTuneIII™ helps to perform the best of system.

Besides, different from other traditional over-clocking methods, EasyTuneIII™ doesn’t require users to change neither BIOS nor hardware switch/ jumper setting; on the other hand, they can do “overdrive” at only one click. Therefore, this is a safer way for “overdrive” as nothing is changed on software or hardware. If user runs EasyTuneIII™ over system’s limitation, the biggest lost is only to restart the computer again and the side effect is then well controlled. Moreover, if one well-performed system speed been tested in EasyTuneIII™, user can “Save” this bus speed and “Load” it in next time. Obviously, Gigabyte EasyTuneIII™ has already turned the “overdrive” technology toward to a newer generation.

This wonderful software is now free bundled in Gigabyte motherboard attached driver CD. Users may make a test drive of "EasyTuneIII™" to find out more amazing features by themselves.

For further technical information, please link to: <http://www.gigabyte.com.tw>

※ Note: If your CD version is 1.6 or below, please visit our website and download the latest EasyTuneIII™ version.

Memory Installation

The motherboard has 2 dual inline memory module (DIMM) sockets. The BIOS will automatically detects memory type and size. To install the memory module, just push it vertically into the DIMM Slot .The DIMM module can only fit in one direction due to the two notch. Memory size can vary between sockets.

Install memory in any combination table:

DIMM	168-pin SDRAM DIMM Modules	
DIMM 1	Supports 16 / 32 / 64 / 128 / 256 / 512 MB	X 1 pcs
DIMM 2	Supports 16 / 32 / 64 / 128 / 256 / 512 MB	X 1 pcs

★Total System Memory (Max 1GB)

6VMM(-P) Motherboard

 Page Index for BIOS Setup	Page
The Main Menu	P.51
Standard CMOS Setup	P.53
BIOS Features Setup	P.56
Chipset Features Setup	P.58
Power Management Setup	P.60
PNP/ PCI Configuration	P.63
Load BIOS Defaults	P.65
Load Setup Defaults	P.66
Integrated Peripherals	P.67
Hardware Monitor Setup	P.71
Supervisor Password / User Password	P.72
IDE HDD Auto Detection	P.73
Save & Exit Setup	P.74
Exit Without Saving	P.75

BIOS Setup

BIOS Setup is an overview of the BIOS Setup Program. The program that allows users to modify the basic system configuration. This type of information is stored in battery-backed CMOS RAM so that it retains the Setup information when the power is turned off.

ENTERING SETUP

Power ON the computer and press immediately will allow you to enter Setup. If the message disappears before you respond and you still wish to enter Setup, restart the system to try again by turning it OFF then ON or pressing the "RESET" bottom on the system case. You may also restart by simultaneously press <Ctrl> – <Alt>– keys.

CONTROL KEYS

<↑>	Move to previous item
<↓>	Move to next item
<←>	Move to the item in the left hand
<→>	Move to the item in the right hand
<Esc>	Main Menu - Quit and not save changes into CMOS Status Page Setup Menu and Option Page Setup Menu - Exit current page and return to Main Menu
<+/PgUp>	Increase the numeric value or make changes
<-/PgDn>	Decrease the numeric value or make changes
<F1>	General help, only for Status Page Setup Menu and Option Page Setup Menu
<F2>	Reserved
<F3>	Reserved
<F4>	Reserved
<F5>	Restore the previous CMOS value from CMOS, only for Option Page Setup Menu
<F6>	Load the default CMOS value from BIOS default table, only for Option Page Setup Menu
<F7>	Load the Setup Defaults.
<F8>	Reserved
<F9>	Reserved
<F10>	Save all the CMOS changes, only for Main Menu

GETTING HELP

Main Menu

The on-line description of the highlighted setup function is displayed at the bottom of the screen.

Status Page Setup Menu / Option Page Setup Menu

Press F1 to pop up a small help window that describes the appropriate keys to use and the possible selections for the highlighted item. To exit the Help Window press <Esc>.

The Main Menu

Once you enter AMI BIOS CMOS Setup Utility, the Main Menu (Figure 1) will appear on the screen. The Main Menu allows you to select from nine setup functions and two exit choices. Use arrow keys to select among the items and press <Enter> to accept or enter the sub-menu.

AMIBIOS SIMPLE SETUP UTILITY-VERSION 1.24a (C) 1999 American Megatrends, Inc. All Rights Reserved	
STANDARD CMOS SETUP	INTEGRATED PERIPHERALS
BIOS FEATURES SETUP	HARDWARE MONITOR SETUP
CHIPSET FEATURES SETUP	SUPERVISOR PASSWORD
POWER MANAGEMENT SETUP	USER PASSWORD
PNP/PCI CONFIGURATION	IDE HDD AUTO DETECTION
LOAD BIOS DEFAULTS	SAVE & EXIT SETUP
LOAD SETUP DEFAULTS	EXIT WITHOUT SAVING
ESC : Quit ↑↓←→ : Select Item (Shift) F2 : Change Color F5 : Old Values F6 : Load BIOS Defaults F7: Load Setup Defaults F10: Save & Exit	
Time, Date, Hard Disk Type, ...	

Figure 1: Main Menu

- **Standard CMOS Setup**
This setup page includes all the items in standard compatible BIOS.
- **BIOS Features Setup**
This setup page includes all the items of AMI special enhanced features.
- **Chipset Features Setup**
This setup page includes all the items of chipset special features.

- **Power Management Setup**

This setup page includes all the items of Green function features.

- **PnP/PCI Configurations**

This setup page includes all the configurations of PCI & PnP ISA resources.

- **Load BIOS Defaults**

Bios Defaults indicates the value of the system parameter which the system would be in the safe configuration.

- **Load Setup Defaults**

Setup Defaults indicates the value of the system parameter which the system would be in the most appropriate configuration.

- **Integrated Peripherals**

This setup page includes all onboard peripherals.

- **Hardware Monitor Setup**

This setup page is auto detect fan and temperature status.

- **Supervisor password**

Change, set, or disable password. It allows you to limit access to the system and Setup, or just to Setup.

- **User password**

Change, set, or disable password. It allows you to limit access to the system.

- **IDE HDD auto detection**

Automatically configure hard disk parameters.

- **Save & Exit Setup**

Save CMOS value settings to CMOS and exit setup.

- **Exit Without Saving**

Abandon all CMOS value changes and exit setup.

Standard CMOS Setup

The items in Standard CMOS Features Menu (Figure 2) are divided into 9 categories. Each category includes no, one or more than one setup items. Use the arrows to highlight the item and then use the <PgUp> or <PgDn> keys to select the value you want in each item.

AMIBIOS SETUP – STANDARD CMOS SETUP (C) 1999 American Megatrends, Inc. All Rights Reserved	
Date (mm/dd/yyyy) : Tue Jan 25, 2000 Time (hh/mm/ss) : 10:36:24	
TYPE SIZE CYLS HEAD PRECOMP LANDZ SECTOR MODE	
Pri Master : Auto Pri Slave : Auto Sec Master : Auto Sec Slave : Auto	
Floppy Drive A: 1.44 MB 3 ½ Floppy Drive B: Not Installed	Base Memory : 640 Kb Other Memory: 384 Kb Extended Memory: 30Mb Total Memory: 31Mb
Boot Sector Virus Protection : Disabled	
Month: Jan – Dec Day: 01 – 31 Year: 1990– 2099	ESC : Exit ↑↓ : Select Item PU/PD/+/- : Modify (Shift)F2 : Color

Figure 2: Standard CMOS Setup

- **Date**

The date format is <Week>, <Month>, <Day>, <Year>.

Week	The week, from Sun to Sat, determined by the BIOS and is display-only
Month	The month, Jan. Through Dec.
Day	The day, from 1 to 31 (or the maximum allowed in the month)
Year	The year, from 1990 through 2099

- **Time**

The times format in <hour> <minute> <second>. The time is calculated base on the 24-hour military-time clock. For example, 1 p.m. is 13:00:00.

- **IDE Primary Master, Slave / Secondary Master, Slave**

The category identifies the types of hard disk from drive C to F that has been installed in the computer. There are two types: auto type, and user definable type. User type is user-definable; Auto type which will automatically detect HDD type.

Note that the specifications of your drive must match with the drive table. The hard disk will not work properly if you enter improper information for this category.

If you select User Type, related information will be asked to enter to the following items. Enter the information directly from the keyboard and press <Enter>. Such information should be provided in the documentation from your hard disk vendor or the system manufacturer.

CYLS.	Number of cylinders
HEADS	number of heads
PRECOMP	write precomp
LANDZONE	Landing zone
SECTORS	number of sectors

If a hard disk has not been installed select NONE and press <Enter>.

- **Drive A type / Drive B type**

The category identifies the types of floppy disk drive A or drive B that has been installed in the computer.

None	No floppy drive installed
360K, 5.25 in.	5.25 inch PC-type standard drive; 360K byte capacity.
1.2M, 5.25 in.	5.25 inch AT-type high-density drive; 1.2M byte capacity (3.5 inch when 3 Mode is Enabled).
720K, 3.5 in.	3.5 inch double-sided drive; 720K byte capacity
1.44M, 3.5 in.	3.5 inch double-sided drive; 1.44M byte capacity.
2.88M, 3.5 in.	3.5 inch double-sided drive; 2.88M byte capacity.

- **Boot Sector Virus Protection**

If it is set to enable, the category will flash on the screen when there is any attempt to write to the boot sector or partition table of the hard disk drive. The system will halt and the following error message will appear in the mean time. You can run anti-virus program to locate the problem.

Enabled	Activate automatically when the system boots up causing a warning message to appear when anything attempts to access the boot sector or hard disk partition table
Disabled	No warning message to appear when anything attempts to access the boot sector or hard disk partition table. (Default Value)

- **Memory**

The category is display-only which is determined by POST (Power On Self Test) of the BIOS.

Base Memory

The POST of the BIOS will determine the amount of base (or conventional) memory installed in the system.

The value of the base memory is typically 512 K for systems with 512 K memory installed on the motherboard, or 640 K for systems with 640 K or more memory installed on the motherboard.

Extended Memory

The BIOS determines how much extended memory is present during the POST.

This is the amount of memory located above 1 MB in the CPU's memory address map.

Other Memory

This refers to the memory located in the 640 K to 1024 K address space. This is memory that can be used for different applications.

DOS uses this area to load device drivers to keep as much base memory free for application programs. Most use for this area is Shadow RAM

BIOS Features Setup

AMIBIOS SETUP – BIOS FEATURES CMOS SETUP (C) 1999 American Megatrends, Inc. All Rights Reserved	
1st Boot Device :Floppy 2nd Boot Device :IDE-0 3rd Boot Device :CDROM S.M.A.R.T for Hard Disks :Disabled BootUp Num-Lock :On Floppy Drive Seek :Disabled Password Check :Setup Processor Serial Number :Disabled	ESC : Quit ↑↓←→: Select Item F1 : Help PU/PD/+/- : Modify F5 : Old Values (Shift)F2 :Color F6 : Load BIOS Defaults F7 : Load Setup Defaults

Figure 3: BIOS Features Setup

- 1st / 2nd / 3rd Boot Device**

The default value is Floppy or LS / ZIP A: or ATAPI ZIP C: or CDROM or SCSI or NETWORK or IDE-0-IDE-3 or USB FDD or Disabled.

Floppy	Boot Device by Floppy.
LS / ZIP A:	Boot Device by LS / ZIP A:.
CDROM	Boot Device by CDROM.
SCSI	Boot Device by SCSI.
NETWORK	Boot Device by NETWORK.
IDE-0-IDE-3	Boot Device by IDE-0-IDE-3.
Disabled	Boot Device by Disabled.
ATAPI ZIP C:	Boot Device by ATAPI ZIP C:.
USB FDD	Boot Device by USB FDD.

- S.M.A.R.T. for Hard Disks**

Enable	Enable S.M.A.R.T. Hard for Disks.
Disable	Disable S.M.A.R.T. Hard for Disks. (Default Value)

- **Boot Up Num-Lock**

On	Keypad is number keys. (Default Value)
Off	Keypad is arrow keys.

- **Floppy Drive Seek**

During POST, BIOS will determine if the floppy disk drive installed is 40 or 80 tracks. 360 type is 40 tracks while 720 , 1.2 and 1.44 are all 80 tracks.

Enabled	BIOS searches for floppy disk drive to determine if it is 40 or 80 tracks. Note that BIOS can not tell from 720, 1.2 or 1.44 drive type as they are all 80 tracks.
Disabled	BIOS will not search for the type of floppy disk drive by track number. Note that there will not be any warning message if the drive installed is 360. (Default Value)

- **Password Check**

Setup	Set Password Check to Setup. (Default Value)
Always	Set Password Check to Always.

- **Processor Serial Number**

Disabled	Disabled CPU Serial Number. (Default Value)
Enabled	Enabled CPU Serial Number.

Chipset Features Setup

AMIBIOS SETUP –CHIPSET FEATURE CMOS SETUP (C) 1999 American Megatrends, Inc. All Rights Reserved	
*** DRAM Timing ***	
SDRAM Timing by SPD	:Disabled
DRAM Frequency	:100 MHz
SDRAM CAS# Latency	:3
DRAM Integrity Mode	:Non-ECC
AGP Mode	:2X
AGP Fast Write	:Disabled
AGP Aperture Size	:64MB
ClkGen Spread Spectrum	:Disabled
USB Controller	:All USB Port
USB Legacy Support	:Disabled
ESC : Quit ↑↓←→: Select Item F1 : Help PU/PD/+/- : Modify F5 : Old Values (Shift)F2 :Color F6 : Load BIOS Defaults F7 : Load Setup Defaults	

Figure 4: Chipset Features Setup

- **SDRAM Timing by SPD**

Disabled	Disabled SDRAM Timing by SPD. (Default Value)
Enabled	Enabled SDRAM Timing by SPD.

- **DRAM Frequency**

100MHz	Set DRAM Frequency is 100MHz. (Default Value)
133MHz	Set DRAM Frequency is 133MHz.

- **SDRAM CAS# Latency**

3	For Slower SDRAM DIMM module. (Default Value)
2	For Fastest SDRAM DIMM module.

- **DRAM Integrity Mode**

ECC	For 72 bit ECC type DIMM Model.
Non-ECC	Normal Setting. (Default Value)

- **AGP Mode**

1X	Set AGP Mode is 1X.
2X	Set AGP Mode is 2X. (Default Value)

- **AGP Fast Write**

Disabled	Disabled AGP Fast Write (Default Value)
Enabled	Enabled AGP Fast Write

- **AGP Aperture Size**

4MB	Set AGP Aperture Size to 4MB.
8MB	Set AGP Aperture Size to 8 MB.
16MB	Set AGP Aperture Size to 16 MB.
32MB	Set AGP Aperture Size to 32 MB.
64MB	Set AGP Aperture Size to 64 MB. (Default Value)
128MB	Set AGP Aperture Size to 128 MB.
256MB	Set AGP Aperture Size to 256 MB.

- **ClkGen Spread Spectrum**

Enabled	Enabled ClkGen Spread Spectrum.
Disabled	Normal function. (Default Value)

- **USB Controller**

All USB Port	Set USB Controller Function used all USB Port. (Default Value)
USB Port 0&1	Set USB Controller Function used USB Port 0&1.
USB Port 2&3	Set USB Controller Function used USB Port 2&3.
Disabled	USB Controller Function Disabled.

- **USB Legacy Support**

Keyboard / FDD	Set USB Legacy Support Keyboard / FDD.
KB / Mouse / FDD	Set USB Legacy Support Keyboard / Mouse / FDD.
Disabled	Disabled USB Legacy Support Function. (Default Value)

Power Management Setup

AMIBIOS SETUP –POWER MANAGEMENT SETUP (C) 1999 American Megatrends, Inc. All Rights Reserved			
ACPI Standby State	:S1/POS	RTC Alarm Date	:15
USB Device Wakeup From S3-S5	:Disabled	RTC Alarm Hour	:12
Suspend Time Out(Minute)	:Disabled	RTC Alarm Minute	:30
Display Activity	:Ignore	RTC Alarm Second	:30
IRQ3	:Monitor		
IRQ 4	:Monitor		
IRQ 5	:Ignore		
IRQ 7	:Monitor		
IRQ 9	:Ignore		
IRQ 10	:Ignore		
IRQ 11	:Ignore		
IRQ 13	:Ignore		
IRQ 14	:Monitor		
IRQ 15	:Ignore		
Soft-off by Power Button	:Instant off		
System after AC Back	:Soft-Off	ESC : Quit	↑↓←→: Select Item
Modem Use IRQ	:4	F1 : Help	PU/PD/+/- : Modify
Resume On Ring / LAN	:Enabled	F5 : Old Values (Shift)F2 :Color	
PME Event Wake up	:Enabled	F6 : Load BIOS Defaults	
RTC Alarm Power On	:Disabled	F7 : Load Setup Defaults	

Figure 5: Power Management Setup

- **ACPI Standby State**

S1/POS	Set ACPI Standby State is S1. (Default Value)
S3/STR	Set ACPI Standby State is S3.

- **USB Device Wakeup From S3-S5**

Disabled	Disabled USB KB Wakeup From S3-S5 function. (Default Value)
Enabled	Enabled USB KB Wakeup From S3-S5 function.

- **Suspend Time Out (Minute.)**

Disabled	Disabled Suspend Time Out Function. (Default Value)
1	Enabled Suspend Time Out after 1min.
2	Enabled Suspend Time Out after 2min.
4	Enabled Suspend Time Out after 4min.
8	Enabled Suspend Time Out after 8min.
10	Enabled Suspend Time Out after 10min.
20	Enabled Suspend Time Out after 20min.
30	Enabled Suspend Time Out after 30min.
40	Enabled Suspend Time Out after 40min.
50	Enabled Suspend Time Out after 50min.
60	Enabled Suspend Time Out after 60min.

- **Display Activity**

Ignore	Ignore Display Activity. (Default Value)
Monitor	Monitor Display Activity.

- **IRQ 3-IRQ15**

Ignore	Ignore IRQ3 -IRQ15.
Monitor	Monitor IRQ3-IRQ15.

- **Soft-off by Power Button**

Instant off	Soft switch ON/OFF for Power Button. (Default Value)
Delay-4Sec	Soft switch ON 4 Sec for Power off.

- **System after AC Back**

Power-Off	Set Restore on AC/Power Loss is Power off.
Full-On	Set Restore on AC/Power Loss is Full on.
Memory	Set Restore on AC/Power Loss is Last state mode. (Default Value)

- **MODEM Use IRQ**

NA	Set MODEM Use IRQ to NA.
3	Set MODEM Use IRQ to 3.
4	Set MODEM Use IRQ to 4. (Default Value)
5	Set MODEM Use IRQ to 5.
7	Set MODEM Use IRQ to 7.

- **Modem Ring On/ LAN**

Disabled	Disabled Modem Ring On / Wake On LAN function.
Enabled	Enabled Modem Ring On / Wake On LAN function. (Default Value)

- **PME Event Wake up**

Disabled	Disabled PME Event Wake up function.
Enabled	Enabled PME Event Wake up function. (Default Value)

- **RTC Alarm Power On**

You can set "RTC Alarm Power On" item to enabled and key in Data/time to power on system.

Disabled	Disable this function. (Default Value)
Enabled	Enable alarm function to POWER ON system.

If RTC Alarm Lead To Power On is Enabled.

RTC Alarm Date :	Every Day,1-31
RTC Alarm Hour:	0-23
RTC Alarm Minute :	0-59
RTC Alarm Second :	0-59

PnP/PCI Configurations

AMIBIOS SETUP –PNP/PCI CONFIGURATION SETUP (C) 1999 American Megatrends, Inc. All Rights Reserved	
Reset Configuration Data	:No
VGA Boot From	:PCI
PCI Slot1 IRQ Priority	:Auto
PCI Slot2 IRQ Priority	:Auto
PCI Slot3 IRQ Priority	:Auto
DMA Channel 0	:PnP
DMA Channel 1	:PnP
DMA Channel 3	:PnP
DMA Channel 5	:PnP
DMA Channel 6	:PnP
DMA Channel 7	:PnP
IRQ3	:PCI/PnP
IRQ4	:PCI/PnP
IRQ5	:PCI/PnP
IRQ7	:PCI/PnP
IRQ9	:PCI/PnP
IRQ10	:PCI/PnP
IRQ11	:PCI/PnP
IRQ14	:PCI/PnP
IRQ15	:PCI/PnP
ESC : Quit ↑↓←→: Select Item F1 : Help PU/PD/+/- : Modify F5 : Old Values (Shift)F2 :Color F6 : Load BIOS Defaults F7 : Load Setup Defaults	

Figure 6: PnP/PCI Configuration

- **Reset Configuration Data**

Yes	Reset configuration data.
No	Disabled this function. (Default Value)

- **VGA Boot From**

Onchip AGP	Primary Graphics Adapter From Add-on AGP.
PCI	Primary Graphics Adapter From OnBoard PCI. (Default Value)

- **PCI Slot 1 ~ Slot 3 IRQ Priority**

Auto	Auto Set PCI Slot 1~Slot 3 IRQ Priority
3,4,5,7,9,10,11	Setting PCI Slot 1~Slot 3 IRQ.

- **DMA Channel (0,1,3,5,6,7)**

PnP	The resource is used by PnP device.
ISA/EISA	The resource is used by ISA / EISA device (PCI or ISA).

- IRQ -(3,4,5,7,9, 10,11), assigned to ("ISA / EISA" or "PCI/PnP")

ISA/EISA	The resource is used by Legacy ISA device.
PCI/PnP	The resource is used by PCI/ PnP device.

Load BIOS Defaults

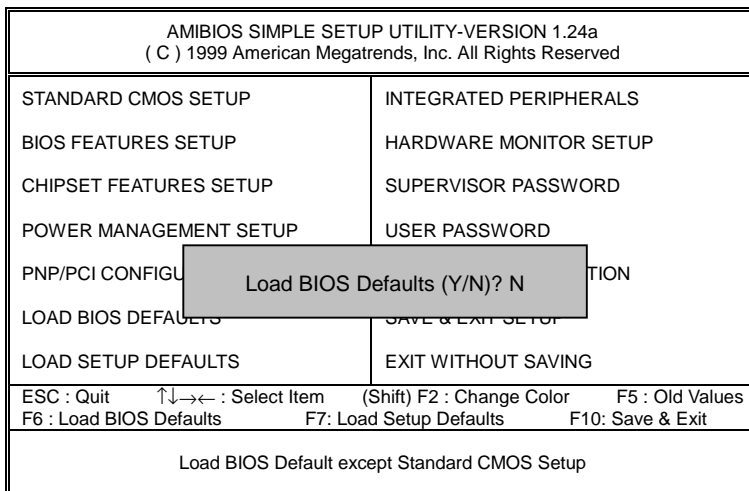

Figure 7: Load BIOS Defaults

- **Load BIOS Defaults**

BIOS defaults contain the most appropriate values of the system parameters that allow minimum system performance.

Load Setup Defaults

AMIBIOS SIMPLE SETUP UTILITY-VERSION 1.24a (C) 1999 American Megatrends, Inc. All Rights Reserved	
STANDARD CMOS SETUP	INTEGRATED PERIPHERALS
BIOS FEATURES SETUP	HARDWARE MONITOR SETUP
CHIPSET FEATURES SETUP	SUPERVISOR PASSWORD
POWER MANAGEMENT SETUP	USER PASSWORD
PNP/PCI CONFIGURATION	LOAD SETUP Defaults (Y/N)? N
LOAD BIOS DEFAULTS	SAVE & EXIT SETUP
LOAD SETUP DEFAULTS	EXIT WITHOUT SAVING
ESC : Quit ↑↓→← : Select Item (Shift) F2 : Change Color F5 : Old Values F6 : Load BIOS Defaults F7: Load Setup Defaults F10: Save & Exit	
Load Setup Default except Standard CMOS Setup	

Figure 8: Load Setup Defaults

- **Load Setup Defaults**

Selecting this field loads the factory defaults for BIOS and Chipset Features which the system automatically detects.

Integrated Peripherals

AMIBIOS SETUP –INTEGRATED PERIPHERAL (C) 1999 American Megatrends, Inc. All Rights Reserved		
OnBoard IDE	:Both	
OnBoard FDC	:Auto	
OnBoard Serial Port 1	:Auto	
OnBoard Serial Port 2	:Auto	
Serial Port2 Mode	:Normal	
Duplex Mode	:N/A	
OnBoard Parallel Port	:Auto	
Parallel Port Mode	:ECP	
Parallel Port DMA	:Auto	
Parallel Port IRQ	:Auto	
OnBoard AC'97 Audio	:Auto	
OnBoard MC'97 Modem	:Auto	
OnBoard Legacy Audio	:Enabled	
Sound Blaster	:Disabled	
SB I/O Base Address	:220h-22Fh	
SB IRQ Select	:IRQ 5	ESC : Quit
SB DMA Select	:DMA1	F1 : Help
MPU-401	:Disabled	F5 : Old Values (Shift)F2 :Color
MPU-401 I/O Address	:330h-333h	F6 : Load BIOS Defaults
Game Port(200h-207h)	:Enabled	F7 : Load Setup Defaults
		↑↓←→: Select Item PU/PD/+/- : Modify

Figure 9: Integrated Peripherals

- **OnBoard IDE**

Disabled	Disabled OnBoard IDE
Both	Set OnBoard IDE is Both (Default Value) .
Primary	Set OnBoard IDE is Primary
Secondary	Set OnBoard IDE is Secondary

- **On Board FDC**

Auto	Set On Board FDC is Auto (Default Value) .
Disabled	Disabled On Board FDC
Enabled	Enabled On Board FDC

- **Onboard Serial Port 1**

Auto	BIOS will automatically setup the port 1 address (Default Value) .
3F8/COM1	Enable onboard Serial port 1 and address is 3F8.
2F8/COM2	Enable onboard Serial port 1 and address is 2F8.
3E8/COM3	Enable onboard Serial port 1 and address is 3E8.
2E8/COM4	Enable onboard Serial port 1 and address is 2E8.
Disabled	Disable onboard Serial port 1.

- **Onboard Serial Port 2**

Auto	BIOS will automatically setup the port 2 address (Default Value) .
3F8/COM1	Enable onboard Serial port 2 and address is 3F8.
2F8/COM2	Enable onboard Serial port 2 and address is 2F8.
3E8/COM3	Enable onboard Serial port 2 and address is 3E8.
2E8/COM4	Enable onboard Serial port 2 and address is 2E8.
Disabled	Disable onboard Serial port 2.

- **Serial Port 2 Mode**

ASKIR	Set onboard I/O chip Serial Port 2 to ASKIR Mode.
IrDA	Set onboard I/O chip Serial Port 2 to IrDA Mode.
Normal	Set onboard I/O chip Serial Port 2 to Normal Mode. (Default Value)

- **Duplex Mode**

Half Duplex	IR Function Duplex Half.
N/A	Disabled this function. (Default Value)
Full Duplex	IR Function Duplex Full.

- **On Board Parallel port**

378	Enable On Board LPT port and address is 378.
278	Enable On Board LPT port and address is 278.
3BC	Enable On Board LPT port and address is 3BC.
Auto	Set On Board LPT port is Auto. (Default Value) .
Disabled	Disable On Board LPT port.

- **Parallel Port Mode**

EPP	Using Parallel port as Enhanced Parallel Port.
ECP	Using Parallel port as Extended Capabilities Port. (Default Value)
Normal	Normal Operation.

- **Parallel Port DMA**

Auto	Set Auto to parallel port mode DMA Channel. (Default Value)
N/A	Disabled this function.
3	Set Parallel Port DMA is 3.
1	Set Parallel Port DMA is 1.
0	Set Parallel Port DMA is 0.

- **Parallel Port IRQ**

7	Set Parallel Port IRQ is 7.
Auto	Set Auto to parallel Port IRQ DMA Channel. (Default Value) .
5	Set Parallel Port IRQ is 5.

- **OnBoard AC'97 Audio**

Auto	Set AC'97 Audio to Auto (Default Value) .
Disabled	Disabled AC'97 Audio.

- **OnBoard MC'97 Modem**

Auto	Set MC'97 Modem to Auto (Default Value) .
Disabled	Disabled MC'97 Modem.

- **OnBoard Legacy Audio**

Enabled	Enabled OnBoard Legacy Audio. (Default Value)
Disabled	Disabled OnBoard Legacy Audio.

- **Sound Blaster**

Enabled	Enabled Sound Blaster.
Disabled	Disabled Sound Blaster. (Default Value)

- **SB I/O Base Address**

220h-22Fh	Set SB I/O Base Address is 220h-22Fh. (Default Value)
280h-28Fh	Set SB I/O Base Address is 280h-28Fh.
260h-26Fh	Set SB I/O Base Address is 260h-26Fh.
240h-24Fh	Set SB I/O Base Address is 240h-24Fh.

- **SB IRQ Select**

IRQ 5 / 7 / 9 / 10. (Default Value: 5)

- **SB DMA Select**

DMA 0 / 1 / 2 / 3. (Default Value: 1)
--

- **MPU-401**

Enabled	Enabled MPU-401.
Disabled	Disabled MPU-401. (Default Value)

- **MUP-401 I/O Address**

330h-333h	Set MUP-401 I/O Address is 330h-333h. (Default Value)
300h-303h	Set MUP-401 I/O Address is 300h-303h.
310h-313h	Set MUP-401 I/O Address is 310h-313h.
320h-323h	Set MUP-401 I/O Address is 320h-323h.

- **Game Port (200h-207h)**

Disabled	Disabled Game Port (200h-207h).
Enabled	Enabled Game Port (200h-207h). (Default Value)

Hardware Monitor

AMIBIOS SETUP –HARDWARE MONITOR	
(C) 1999 American Megatrends, Inc. All Rights Reserved	
Case Open Status	:Opened
Current CPU Temp.	:36°C/96°F
Current System Temp.	:28°C/82°F
Current CPU Fan Speed	:5487 RPM
Current System Fan Speed	:0 RPM
Vcore	:2.075V
+3.300V	:3.590V
+5.000V	:5.119V
+12.000V	:11.926V
ESC : Quit ↑↓←→: Select Item F1 : Help PU/PD/+/- : Modify F5 : Old Values (Shift)F2 : Color F6 : Load BIOS Defaults F7 : Load Setup Defaults	

Figure 10: Hardware Monitor

- **Case Open Status**

If the case is closed, "Case Open Status" will show "Closed".

If the case have been opened, "Case Opened" will show "Open".

- **Current CPU Temp. (°C / °F)**

Detect CPU Temperature automatically.

- **Current System Tem. (°C / °F)**

Detect System Temperature automatically.

- **Current CPU FAN Speed**

Detect CPU Fan speed status automatically .

- **Current System FAN Speed**

Detect System Fan speed status automatically .

- **Current Voltage (V) VCORE / +3.3V / +12V / +5V**

Detect system's voltage status automatically.

Set Supervisor / User Password

When you select this function, the following message will appear at the center of the screen to assist you in creating a password.

AMIBIOS SIMPLE SETUP UTILITY-VERSION 1.24a (C) 1999 American Megatrends, Inc. All Rights Reserved	
STANDARD CMOS SETUP	INTEGRATED PERIPHERALS
BIOS FEATURES SETUP	HARDWARE MONITOR SETUP
CHIPSET FEATURES SETUP	SUPERVISOR PASSWORD
POWER MANAGEMENT SETUP	USER PASSWORD
PNP/PCI CONFIGURATION	Enter new supervisor password: <input type="text"/>
LOAD BIOS DEFAULTS	SAVE & EXIT SETUP
LOAD SETUP DEFAULTS	EXIT WITHOUT SAVING
ESC : Quit ↑↓→← : Select Item (Shift) F2 : Change Color F5 : Old Values F6 : Load BIOS Defaults F7 : Load Setup Defaults F10 : Save & Exit	
Chang /Set /Disabled Password	

Figure 11: Password Setting

Type the password, up to eight characters, and press <Enter>. The password typed now will clear the previously entered password from CMOS memory. You will be asked to confirm the password. Type the password again and press <Enter>. You may also press <Esc> to abort the selection and not enter a password.

To disable password, just press <Enter> when you are prompted to enter password. A message "PASSWORD DISABLED" will appear to confirm the password being disabled. Once the password is disabled, the system will boot and you can enter Setup freely.

If you select "Always" at "Password Check" Option in BIOS Features Setup Menu, you will be prompted for the password every time the system is rebooted or any time you try to enter Setup Menu. If you select "Setup" at "Password Check" Option in BIOS Features Setup Menu, you will be prompted only when you try to enter Setup.

IDE HDD AUTO Detection

AMIBIOS SETUP – STANDARD CMOS SETUP (C) 1999 American Megatrends, Inc. All Rights Reserved							
Date (mm/dd/yyyy) : Tue Jan 25, 2000							
Time (hh/mm/ss) : 10:36:24							
TYPE	SIZE	CYLS	HEAD	PRECOMP	LANDZ	SECTOR	MODE
Pri Master : Not Installed							
Pri Slave : Not Installed							
Sec Master : Not Installed							
Sec Slave : Not Installed							
Floppy Drive A: 1.44 MB 3 ½				Base Memory : 640 Kb			
Floppy Drive B: Not Installed				Other Memory: 384 Kb			
				Extended Memory: 31Mb			
Boot Sector Virus Protection : Disabled				Total Memory: 32Mb			
Month: Jan – Dec				ESC : Exit			
Day: 01 – 31				↑↓ : Select Item			
Year: 1990– 2099				PU/PD/+/- : Modify			
				(Shift)F2 : Color			

Figure 12: IDE HDD Auto Detection

Type "Y" will accept the H.D.D. parameter reported by BIOS.

Type "N" will keep the old H.D.D. parameter setup. If the hard disk cylinder number is over 1024, then the user can select LBA mode or LARGER mode for DOS partition larger than 528 MB.

Save & Exit Setup

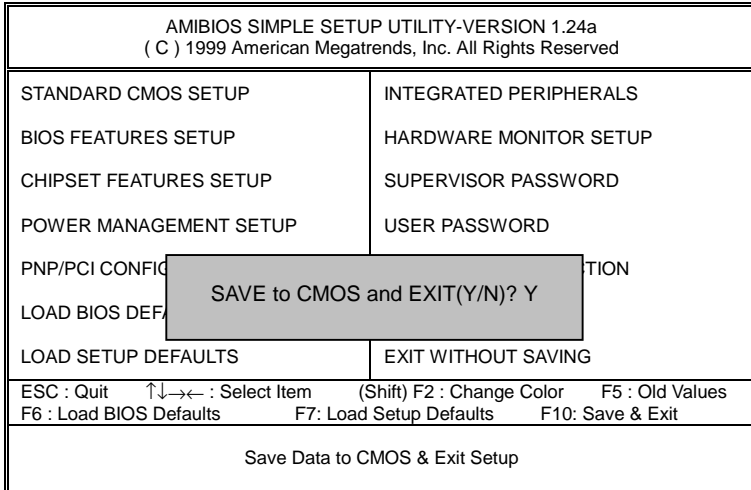

Figure 13: Save & Exit Setup

Type "Y" will quit the Setup Utility and save the user setup value to RTC CMOS.

Type "N" will return to Setup Utility.

Exit Without Saving

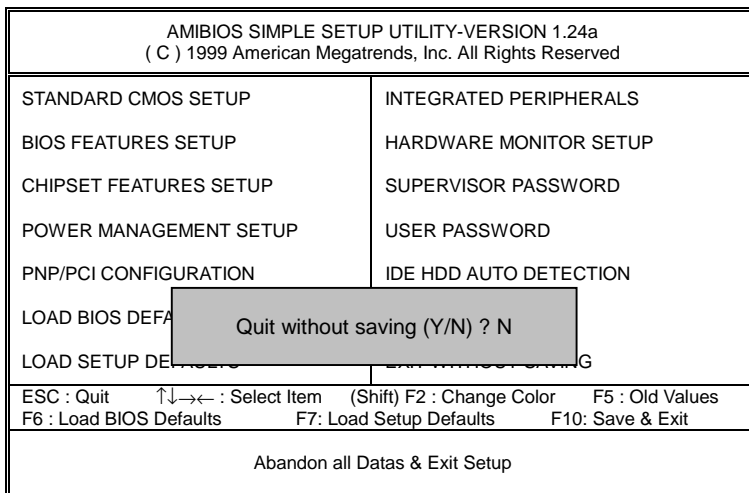

Figure 14: Exit Without Saving

Type "Y" will quit the Setup Utility without saving to RTC CMOS.

Type "N" will return to Setup Utility.

Appendix

Appendix A : VIA Chipsets Driver Installation

A.VIA 4 in 1 Service Pack Utility:

Insert the support CD that came with your motherboard into your CD-ROM driver or double –click the CD driver icon in My Computer to bring up the screen.

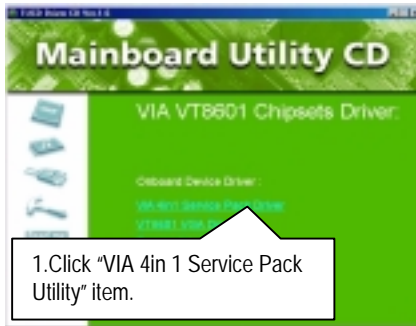

1.Click "VIA 4 in 1 Service Pack Utility" item.

(1)

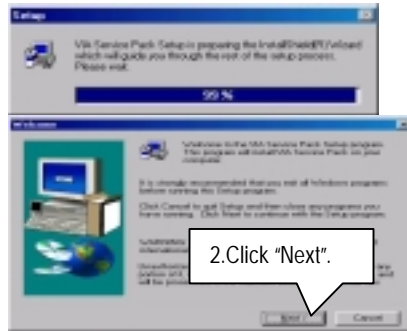

2.Click "Next".

(2)

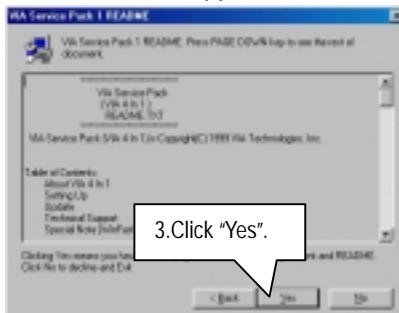

3.Click "Yes".

(3)

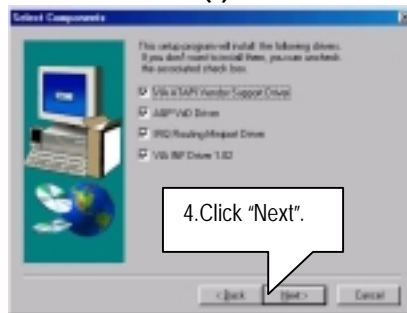

4.Click "Next".

(4)

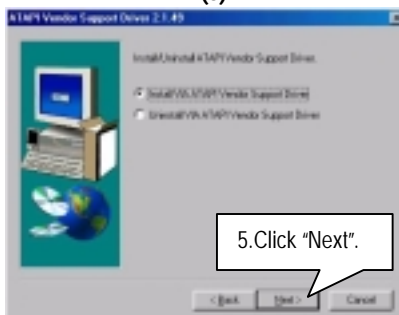

5.Click "Next".

(5)

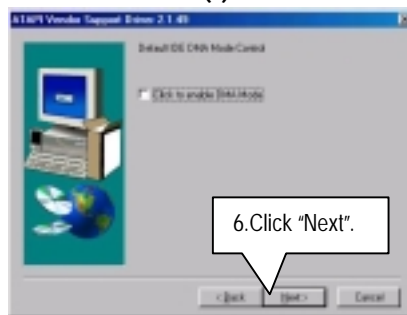

6.Click "Next".

(6)

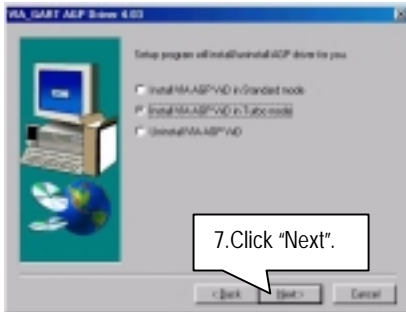

(7)

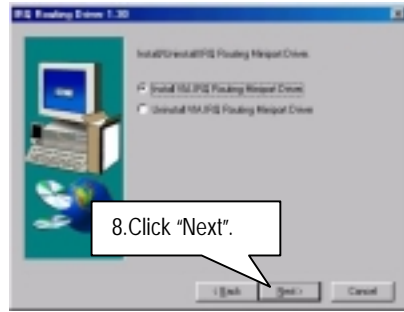

(8)

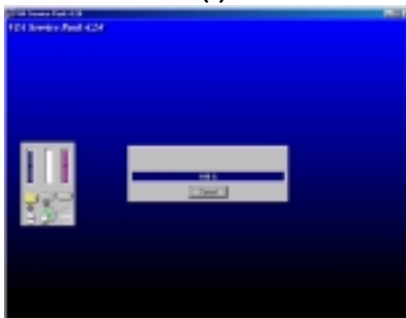

(9)

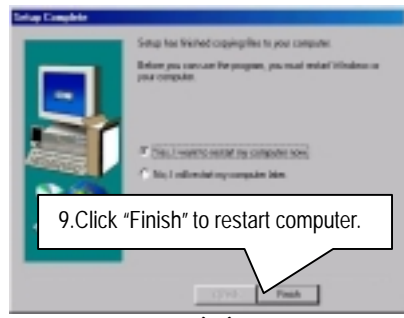

(10)

B. VT8601 VGA Driver Installation:

Insert the support CD that came with your motherboard into your CD-ROM driver or double-click the CD driver icon in My Computer to bring up the screen.

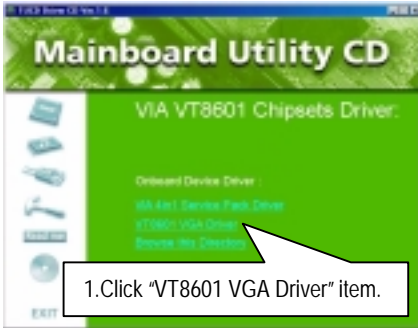

(1)

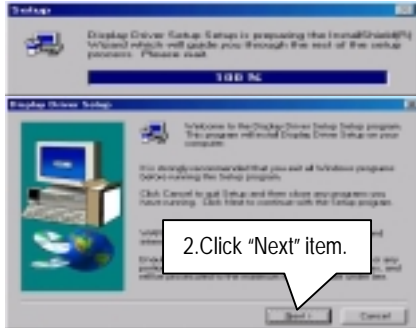

(2)

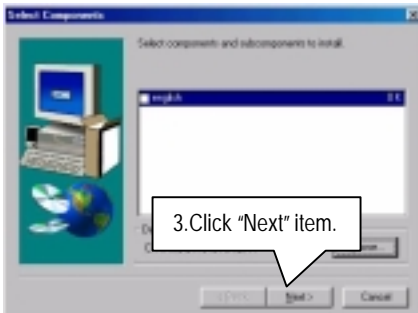

(3)

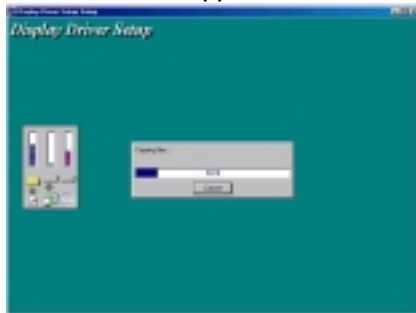

(4)

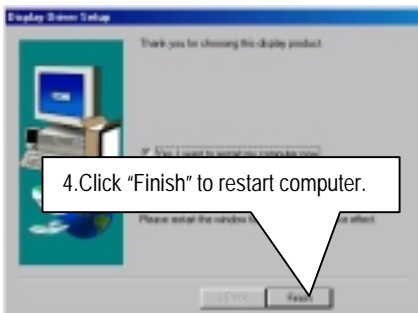

(5)

C. AC'97 Audio Driver:

Insert the support CD that came with your motherboard into your CD-ROM driver or double-click the CD driver icon in My Computer to bring up the screen.

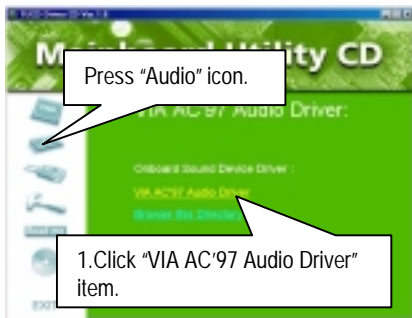

(1)



(2)



(3)

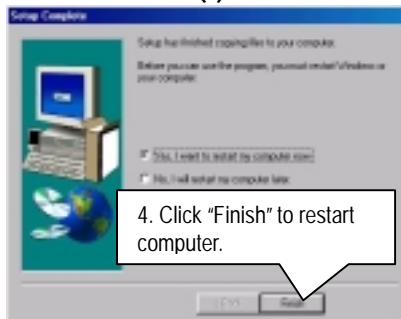

(4)

Appendix B: BIOS Flash Procedure

BIOS update procedure:

If your OS is Win9X, we recommend that you used Gigabyte @BIOS Program to flash BIOS.

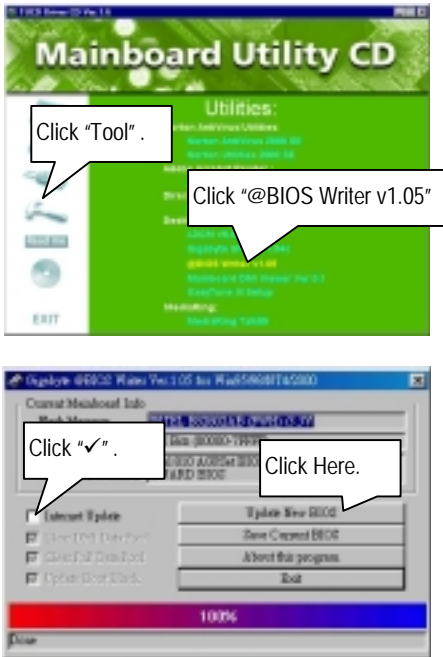

Methods and steps :

- I. Update BIOS through Internet
 - a. Click "Internet Update" icon
 - b. Click "Update New BIOS" icon
 - c. Select @BIOS sever ("Gigabyte @BIOS sever 1 in Taiwan" and "Gigabyte @BIOS sever 2 in Taiwan" are available for now, the others will be completed soon)
 - d. Select the exact model name on your motherboard
 - e. System will automatically download and update the BIOS.

II. Update BIOS **NOT** through Internet :

- a. **Do not** click "Internet Update" icon
- b. Click "Update New BIOS"
- c. Please select "All Files" in dialog box while opening the old file.
- d. Please search for BIOS unzip file, downloading from internet or any other methods (such as: 6VMM(-P).F1).
- e. Complete update process following the instruction.

III. Save BIOS

In the very beginning, there is "Save Current BIOS" icon shown in dialog box. It means to save the current BIOS version.

IV. Check out supported motherboard and Flash ROM :

In the very beginning, there is "About this program" icon shown in dialog box. It can help you check out which kind of motherboard and which brand of Flash ROM are supported.

Note :

- a. In method I, if it shows two or more motherboard's model names to be selected, please make sure your motherboard's model name again. Selecting name will cause the system unbooted.
- b. In method II, be sure that motherboard's model name in BIOS unzip file are the same as your motherboard's. Otherwise, your system won't boot.
- c. In method I, if the BIOS file you need cannot be found in @BIOS server, please go onto Gigabyte's web site for downloading and updating it according to method II.
- d. Please note that any intercorruption during updating will cause system unbooted

Or else you can select flash BIOS in DOS mode.

● Please check your **BIOS vendor (AMI or AWARD)**, your **motherboard name** and **PCB version** on the motherboard.

1. Format a bootable system floppy diskette by the command "**format a:/s**" in command mode.
2. Visit the Gigabyte website at [http:// www.gigabyte.com.tw](http://www.gigabyte.com.tw) ,Select the BIOS file you need and download it to your bootable floppy diskette.
3. Insert the bootable diskette containing the BIOS file into the floppy diskette driver.
4. Assuming that the floppy diskette driver is A, reboot the system by using the A: driver. At the A: > prompt, run the BIOS upgraded file by executing the Flash BIOS utility and the BIOS file with its appropriate extension.

Example: *(AMI tool) (Where 6VMM(-P).f1 is name of the BIOS file name)*

```
A:>flashxxx.exe 6 VMM-P.f1 ↵
```

Example: *(Award tool) (Where 6VMM(-P).f1 is name of the BIOS file name)*

```
A:>wdf1ash.exe 6 VMM-P.f1 ↵
```

5. Upon pressing the <Enter> key, a flash memory writer menu will appear on screen. Enter the new BIOS file name with its extension filename into the text box after file name to program.
6. If you want to save the old BIOS file(perform as soon as system is operational, this is recommended), select Y to **DO YOU WANT TO SAVE BIOS**, then type the old BIOS filename and the extension after filename to save: This option allows you to copy the contents of the flash memory chip onto a diskette, giving you a backup copy of the original motherboard BIOS in case you need to re-install it. Select N to **DO YOU WANT TO SAVE BIOS**, if you don't want to save the old BIOS file.
7. After the decision to save the old BIOS file or not is made, select Y to **ARE YOU SURE TO PROGRAM** when the next menu appear; wait until a message showing Power Off or Reset the system appears. Then turn off your system.
8. Remove the diskette and restart your system.
9. Hold down <Delete> key to enter BIOS setup. You must select "Load Setup BIOS Default" to activate the new BIOS, then you may set other item from the main menu.

Appendix C: Acronyms

Acor.	Meaning
ACPI	Advanced Configuration and Power Interface
POST	Power-On Self Test
LAN	Local Area Network
ECP	Extended Capabilities Port
APM	Advanced Power Management
DMA	Direct Memory Access
MHz	Megahertz
ESCD	Extended System Configuration Data
CPU	Central Processing Unit
SMP	Symmetric Multi-Processing
USB	Universal Serial Bus
OS	Operating System
ECC	Error Checking and Correcting
IDE	Integrated Dual Channel Enhanced
SCI	Special Circumstance Instructions
LBA	Logical Block Addressing
EMC	Electromagnetic Compatibility
BIOS	Basic Input / Output System
SMI	System Management Interrupt
IRQ	Interrupt Request
NIC	Network Interface Card
A.G.P.	Accelerated Graphics Port
S.E.C.C.	Single Edge Contact Cartridge
LED	Light Emitting Diode
EPP	Enhanced Parallel Port
CMOS	Complementary Metal Oxide Semiconductor
I/O	Input / Output
ESD	Electrostatic Discharge
OEM	Original Equipment Manufacturer
SRAM	Static Random Access Memory
VID	Voltage ID
DMI	Desktop Management Interface
MIDI	Musical Interface Digital Interface
IOAPIC	Input Output Advanced Programmable Input Controller
DIMM	Dual Inline Memory Module
DRAM	Dynamic Random Access Memory
PAC	PCI A.G.P. Controller
AMR	Audio Modem Riser

To be continued...

Acor.	Meaning
PCI	Peripheral Component Interconnect
RIMM	Rambus in-line Memory Module
DRM	Dual Retention Mechanism
ISA	Industry Standard Architecture
MTH	Memory Translator Hub
CRIMM	Continuity RIMM