



When you installing AGP card, please make sure the following notice is fully understood and practiced. If your AGP card has "AGP 4X notch"(show below), please make sure your AGP card is AGP 4X (1.5V).



Do not use AGP 2X card (3.3V) in this motherboard. It will burn and damage the motherboard due to Intel® 845 chipset can't support AGP 2X(3.3V)..

Example 1: Diamond Vipper V770 golden finger is compatible with 2X/4X mode AGP slot. It can be switched between AGP 2X(3.3V) or 4X(1.5V) mode by adjusting the jumper. The factory default for this card is 2X(3.3V). If you install this card in GA-8IRM series (or any AGP 4X only) motherboards without switching the jumper to 4X mode (1.5V), it will burn the motherboard.

Example 2: ATi Rage 128 Pro (Power Color)& SiS 305 golden finger is compatible with 2X/4X mode AGP slot, but it supports 2X(3.3V) only. If you install this card in GA-8IRM series (or any AGP 4X only) motherboards, it will burn the motherboard.

Note : Although Gigabyte's AG32S graphics card is based on ATi Rage 128 Pro chip, the design of AG32S is compliance with AGP 4X (1.5V) specification. Therefore, AG32S will work fine with Intel 845 / 850 based motherboards.



- ✍ The author assumes no responsibility for any errors or omissions that may appear in this document nor does the author make a commitment to update the information contained herein.
- ✍ Third-party brands and names are the property of their respective owners.
- ✍ Please do not remove any labels on motherboard, this may void the warranty of this motherboard.
- ✍ Due to rapid change in technology, some of the specifications might be out of date before publication of this booklet.



Mise en garde : Ne faites jamais retirer le processeur sans que le dissipateur de chaleur soit fixé correctement et fermement car UN DOMMAGE PERMANENT EN RÉSULTE !  
Achtung: Der Prozessor darf nur in Betrieb genommen werden, wenn der Wärmehaube  
sicher und fest angebracht ist. DIES KÖN FÜR EINEN PERMANENTEN  
SCHADEN ZUR FOLGE!  
Advertencia: Nunca desmonte el procesador si el disipador de calor no está instalado y  
firmemente. SE PRODUCIRÁ UN DAÑO PERMANENTE.  
Atenção: Nunca execute o processador sem o dissipador de calor estar adequadamente e firmemente  
conectado. O RESULTADO SERÁ UM DANO PERMANENTE.

警告：務必將散熱器正確安裝在CPU上，否則CPU將永久損壞！

警告：安裝散熱器時，務必將其安裝牢固，否則CPU將永久損壞！

警告：切勿拆卸CPU，除非散熱器已正確安裝且安裝牢固。否則CPU將永久損壞！

警告：務必將散熱器正確安裝在CPU上，否則CPU將永久損壞！

## Declaration of Conformity

We, Manufacturer/Importer  
(full address)

**G.B.T. Technology Trading GmbH**  
Ausschlagweg 41, 1F, 20537 Hamburg, Germany

declare that the product  
(description of the apparatus, system, installation to which it refers)

### **Mother Board**

GA-8IRM/GA-8IRML  
is in conformity with

(reference to the specification under which conformity is declared)  
in accordance with 89/336 EEC-EMC Directive

EN 55011	Limits and methods of measurement of radio disturbance characteristics of industrial, scientific and medical (ISM) high frequency equipment	EN 61000-3-2* EN 61555-2	Disturbances in supply systems cause by household appliances and similar electrical equipment " Harmonics"
EN 55013	Limits and methods of measurement of radio disturbance characteristics of broadcast receivers and associated equipment	EN 61000-3-3* EN 61555-3	Disturbances in supply systems cause by household appliances and similar electrical equipment " Voltage fluctuations"
EN 55014	Limits and methods of measurement of radio disturbance characteristics of household electrical appliances, portable tools and similar electrical apparatus	EN 5081-1 EN 5082-1	Generic emission standard Part 1: Residual commercial and light industry Generic immunity standard Part 1: Residual commercial and light industry
EN 55015	Limits and methods of measurement of radio disturbance characteristics of fluorescent lamps and luminaries	EN 5081-2	Generic emission standard Part 2: Industrial environment
EN 55020	Immunity from radio interference of broadcast receivers and associated equipment	EN 5082-2	Generic emission standard Part 2: Industrial environment
EN 55022	Limits and methods of measurement of radio disturbance characteristics of information technology equipment	ENV 55104	Immunity requirements for household appliances tools and similar apparatus
DIN VDE 0855 part 10 part 12	Cabled distribution systems: Equipment for receiving and/or distribution from sound and television signals	EN 50091-2	EMC requirements for uninterruptible powersystems (UPS)
CE marking			(EC conformity marking)

The manufacturer also declares the conformity of above mentioned product  
with the actual required safety standards in accordance with LVD 73/23/EEC

EN 60065	Safety requirements for mains operated electronic and related apparatus for household and similar general use	EN 60950
EN 60335	Safety of household and similar electrical appliances	EN 50091-1

### Manufacturer/Importer

(S la mp)

Date: Nov. 10, 2001

Signature: Timmy Huang  
Name: Timmy Huang

## **DECLARATION OF CONFORMITY**

Per FCC Part 2 Section 2.1077(a)



**Responsible Party Name: G.B.T. INC. (U.S.A.)**

**Address: 17358 Railroad Street**

**City of Industry, CA 91748**

**Phone/Fax No: (818) 854-9338 / (818) 854-9339**

hereby declares that the product

**Product Name: Motherboard**

**Model Number: GA-8IRM/GA-8IRML**

Conforms to the following specifications:

FCC Part 15, Subpart B, Section 15.107(a) and Section 15.109  
(a), Class B Digital Device

### **Supplementary Information:**

This device complies with part 15 of the FCC Rules. Operation is subject to the following two conditions: (1) This device may not cause harmful and (2) this device must accept any interference received, including that may cause undesired operation.

Representative Person's Name: ERIC LU

Signature: Eric Lu

Date: Nov. 10, 2001

GA-8IRM Series  
P4 Titan-DDR Motherboard

# **USER'S MANUAL**

Pentium®4 Processor Motherboard

Rev. 2.2 First Edition

12ME-8IRM-2201

## **Table of Content**

Revision History .....	4
Item Checklist .....	4
WARNING! .....	5
Chapter 1 Introduction .....	6
Features Summary.....	6
GA-8IRM Series Motherboard Layout .....	8
Chapter 2 Hardware Installation Process .....	9
Step 1: Install the Central Processing Unit (CPU) .....	10
CPU Installation .....	10
CPU Heat Sink Installation .....	11
Step 2: Install memory modules .....	12
Step 3: Install expansion cards .....	13
Step 4: Connect ribbon cables, cabinet wires, and power supply .....	14
I/O Back Panel Introduction .....	14
Connectors Introduction .....	16
Chapter 3 BIOS Setup .....	22
The Main Menu (For example: BIOS Ver. :F3b) .....	23
Standard CMOS Features .....	25
Advanced BIOS Features .....	28
Advanced Chipset Features .....	31
Integrated Peripherals .....	34

---

Power Management Setup .....	42
PnP/PCI Configurations .....	46
PC Health Status .....	48
Frequency/Voltage Control .....	50
Load Fail-Safe Defaults .....	52
Load Optimized Defaults .....	53
Set Supervisor/User Password .....	54
Save & Exit Setup .....	55
Exit Without Saving .....	56
Chapter 4 Technical Reference .....	57
Performance List .....	57
Block Diagram .....	58
@ BIOS Introduction .....	59
Easy Tunell™ Introduction .....	60
Chapter 5 Appendix .....	61

## Revision History

Revision	Revision Note	Date
2.2	Initial release of the GA-8IRM Series motherboard user's manual.	Feb. 2002

## Item Checklist

- ✍ The GA-8IRM Series motherboard
- ✍ IDE cable x 1/ Floppy cable x 1
- ✍ CD for motherboard driver & utility (IUCD)
- ✍ I/O Shield
- ✍ GA-8IRM Series user's manual
- ✍ USB Cable x 1



---

## WARNING!



Computer motherboards and expansion cards contain very delicate Integrated Circuit (IC) chips. To protect them against damage from static electricity, you should follow some precautions whenever you work on your computer.

1. Unplug your computer when working on the inside.
2. Use a grounded wrist strap before handling computer components. If you do not have one, touch both of your hands to a safely grounded object or to a metal object, such as the power supply case.
3. Hold components by the edges and try not touch the IC chips, leads or connectors, or other components.
4. Place components on a grounded antistatic pad or on the bag that came with the components whenever the components are separated from the system.
5. Ensure that the ATX power supply is switched off before you plug in or remove the ATX power connector on the motherboard.

### Installing the motherboard to the chassis...

If the motherboard has mounting holes, but they don't line up with the holes on the base and there are no slots to attach the spacers, do not become alarmed you can still attach the spacers to the mounting holes. Just cut the bottom portion of the spacers (the spacer may be a little hard to cut off, so be careful of your hands). In this way you can still attach the motherboard to the base without worrying about short circuits. Sometimes you may need to use the plastic springs to isolate the screw from the motherboard PCB surface, because the circuit wire may be near by the hole. Be careful, don't let the screw contact any printed circuit write or parts on the PCB that are near the fixing hole, otherwise it may damage the board or cause board malfunctioning.

## Chapter 1 Introduction

### Features Summary

Form Factor	☞ 20.7cm x 24.3cm Micro ATX size form factor, 4 layers PCB.
Motherboard	☞ GA-8IRM Series Motherboard: GA-8IRM and GA-8IRML
CPU	☞ Socket 478 for Intel® Micro FC-PGA2 Pentium® 4 processor ☞ Support Intel® Pentium® 4 (Northwood, 0.13um) processor ☞ Intel Pentium®4 400MHz FSB ☞ 2nd cache depend on CPU
Chipset	☞ Chipset 82845 HOST/AGP/Controller ☞ 82801BA(ICH2) I/O Controller Hub
Memory	☞ 2 184-pin DDR DIMM sockets ☞ Supports PC1600 DDR or PC2100 DDR SDRAM ☞ Supports up to 2GB DRAM (Max) ☞ Supports only 2.5V DDR SDRAM ☞ Supports 64bit ECC type DRAM integrity mode
I/O Control	☞ W83627HF
Slots	☞ 1 AGP slot 4X (1.5V) device support ☞ 3 PCI slot supports 33MHz & PCI 2.2 compliant
On-Board IDE	☞ An IDE controller on the Intel 82801BA PCI chipset provides IDE HDD/CD-ROM with PIO, Bus Master (Ultra DMA33/ATA66/ATA100) operation modes. ☞ Can connect up to four IDE devices
On-Board Peripherals	☞ 1 Floppy port supports 2 FDD with 360K, 720K, 1.2M, 1.44M and 2.88M bytes. ☞ 1 Parallel port supports Normal/EPP/ECP mode ☞ 2 Serial ports (COMA&COMB) ☞ 4 USB ports (Rear USB x 2, Front USB x 2) ☞ 1 IrDA connector for IR
Hardware Monitor	☞ CPU/Power/System Fan Revolution detect ☞ CPU/Power/System Fan Control ☞ CPU Overheat Warning

to be continued.....

---

	☞ System Voltage Detect
On-Board Sound	☞ AC97 CODEC (RealTek ALC201A)
	☞ Line In/Line Out/AUXIn/CD In/TEL/Mic In/CD In/Game Port
On-Board LAN	☞ Build in 82562ET Chipset *
PS/2 Connector	☞ PS/2 Keyboard interface and PS/2 Mouse interface
BIOS	☞ Licensed AWARD BIOS, 2M bit FWH
Additional Features	☞ Internal / External Modem wake up
	☞ PS/2 Keyboard password power on
	☞ PS/2 Mouse power on
	☞ Wake on LAN
	☞ AC Recovery
	☞ USB KB/Mouse wake up from S3
	☞ Poly fuse for keyboard,USB,game port over-current protection
	☞ Supports @BIOS
	☞ Supports EasyTuneII

---



Please set the CPU host frequency in accordance with your processor's specifications. We don't recommend you to set the system bus frequency over the CPU's specification because these specific bus frequencies are not the standard specifications for CPU, chipset and most of the peripherals. Whether your system can run under these specific bus frequencies properly will depend on your hardware configurations, including CPU, Chipsets, SDRAM, Cards....etc.

**\* For GA-8IRML Only.**

## GA-8IRM Series Motherboard Layout

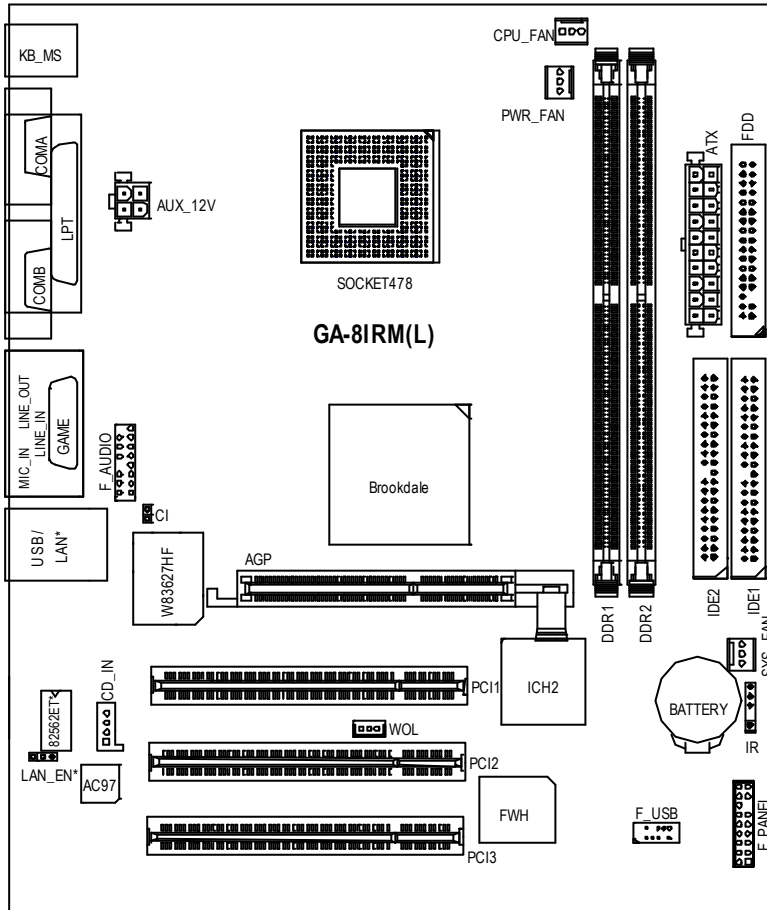

\* For GA-8IRML only.

## Chapter 2 Hardware Installation Process

To setup your computer, you must complete the following steps:

- Step 1- Install the Central Processing Unit (CPU)
- Step 2- Install memory modules
- Step 3- Install expansion cards
- Step 4- Connect ribbon cables, cabinet wires, and power supply
- Step 5- Setup BIOS software
- Step 6- Install supporting software tools

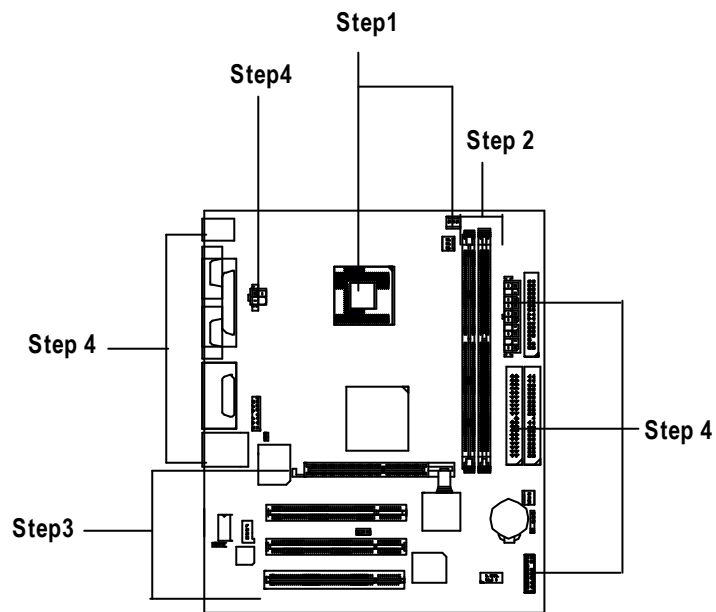

## Step 1: Install the Central Processing Unit (CPU)

### CPU Installation



CPU Top View

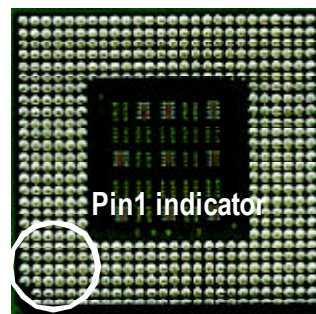

CPU Bottom View

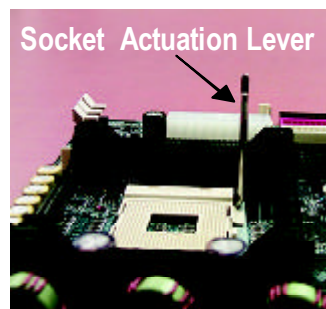

1. Pull up the CPU socket lever and up to 90-degree angle.
3. Press down the CPU socket lever and finish CPU installation.

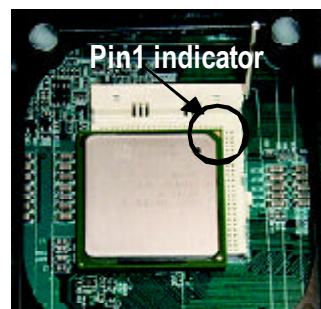

2. Locate Pin 1 in the socket and look for a (golden) cut edge on the CPU upper corner. Then insert the CPU into the socket.

- ⚠ Please make sure the CPU type is supported by the motherboard.
- ⚠ If you do not match the CPU socket Pin 1 and CPU cut edge well, it will cause improper installation. Please change the insert orientation.

## CPU Heat Sink Installation



1. Hook one end of the cooler bracket to the CPU socket first.

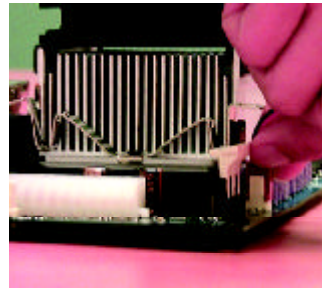

2. Hook the other end of the cooler bracket to the CPU socket.

- ✍ **Please use Intel approved cooling fan.**
- ✍ **We recommend you to apply the thermal tape to provide better heat conduction between your CPU and heatsink.**  
(The CPU cooling fan might stick to the CPU due to the hardening of the thermal paste. During this condition if you try to remove the cooling fan, you might pull the processor out of the CPU socket along with the cooling fan, and might damage the processor. To avoid this from happening, we suggest you to either use thermal tape instead of thermal paste, or remove the cooling fan with extreme caution.)
- ✍ **Make sure the CPU fan power cable is plugged in to the CPU fan connector, this completes the installation.**
- ✍ **Please refer to CPU heat sink user's manual for more detail installation procedure.**

## Step 2: Install memory modules

The motherboard has 2 dual inline memory module (DIMM) sockets. The BIOS will automatically detects memory type and size. To install the memory module, just push it vertically into the DIMM Slot. The DIMM module can only fit in one direction due to the notch. Memory size can vary between sockets.

### Total Memory Sizes With Unbuffered DDR DIMM

Devices used on DIMM	1 DIMM x 64 / x 72	2 DIMMs x 64 / x 72
64 Mbit (2Mx 8x4 banks)	128 MBytes	256 MBytes
64 Mbit (1Mx 16x4 banks)	32 MBytes	64 MBytes
128 Mbit(4Mx 8x4 banks)	256 MBytes	512 MBytes
128 Mbit(2Mx 16x4 banks)	64 MBytes	128 MBytes
256 Mbit(8Mx 8x4 banks)	512 MBytes	1 GBytes
256 Mbit(4Mx 16x4 banks)	128 MBytes	256 MBytes
512 Mbit(16Mx 8x4 banks)	1 GBytes	2 GBytes
512 Mbit(8Mx 16x4 banks)	256 MBytes	512 MBytes

Notes: Double-sided x 16 DDR memory devices are not support by Intel 845 chipset.

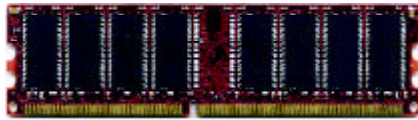

DDR

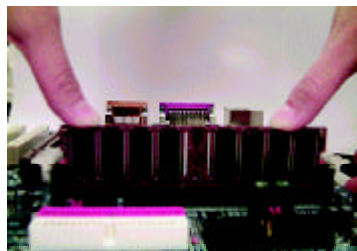

1. The DIMM slot has a notch, so the DIMM memory module can only fit in one direction.
2. Insert the DIMM memory module vertically into the DIMM slot. Then push it down.
3. Close the plastic clip at both edges of the DIMM slots to lock the DIMM module.

Reverse the installation steps when you wish to remove the DIMM module.

**⚠ When STR/DIMM LED is ON, you do not install / remove DDR from socket.**



## DDR Introduction

Established on the existing SDRAM industry infrastructure, DDR (Double Data Rate) memory is a high performance and cost-effective solution that allows easy adoption for memory vendors, OEMs and system integrators.

DDR memory is a sensible evolutionary solution for the PC industry that builds on the existing SDRAM infrastructure, yet makes awesome advances in solving the system performance bottleneck by doubling the memory bandwidth. DDR SDRAM will offer a superior solution and migration path from existing SDRAM designs due to its availability, pricing and overall market support. PC2100 DDR memory (DDR266) doubles the data rate through reading and writing at both the rising and falling edge of the clock, achieving data bandwidth 2X greater than PC133 when running with the same DRAM clock frequency. With peak bandwidth of 2.1GB per second, DDR memory enables system OEMs to build high performance and low latency DRAM subsystems that are suitable for servers, workstations, high-end PC's and value desktop SMA systems. With a core voltage of only 2.5 Volts compared to conventional SDRAM's 3.3 volts, DDR memory is a compelling solution for small form factor desktops and notebook applications.

## Step 3: Install expansion cards

1. Read the related expansion card's instruction document before install the expansion card into the computer.
2. Remove your computer's chassis cover, necessary screws and slot bracket from the computer.
3. Press the expansion card firmly into expansion slot in motherboard.
4. Be sure the metal contacts on the card are indeed seated in the slot.
5. Replace the screw to secure the slot bracket of the expansion card.
6. Replace your computer's chassis cover.
7. Power on the computer, if necessary, setup BIOS utility of expansion card from BIOS.
8. Install related driver from the operating system.

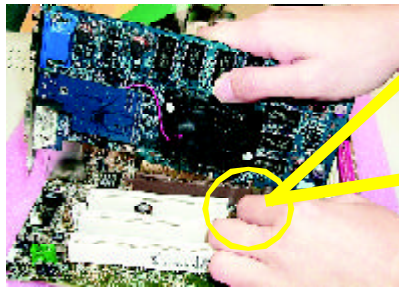

AGP Card

Please carefully pull out the small white-drawable bar at the end of the AGP slot when you try to install/ Uninstall the AGP card. Please align the AGP card to the onboard AGP slot and press firmly down on the slot. Make sure your AGP card is locked by the small white-drawable bar.

## Step 4: Connect ribbon cables, cabinet wires, and power supply

### I/O Back Panel Introduction

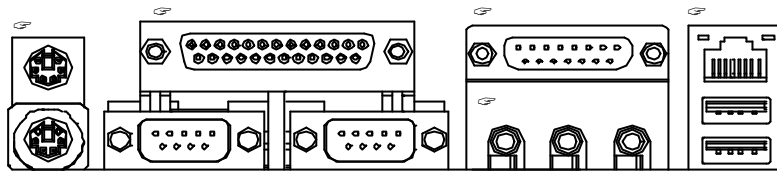

#### PS/2 Keyboard and PS/2 Mouse Connector



PS/2 Mouse Connector  
(6 pin Female)

PS/2 Keyboard Connector  
(6 pin Female)

⚡ This connector supports standard PS/2 keyboard and PS/2 mouse.

#### Parallel Port and Serial Ports (COM1/COM2)

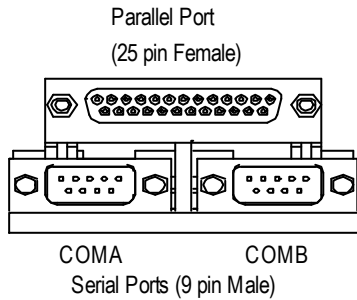

Parallel Port  
(25 pin Female)

COMA      COMB  
Serial Ports (9 pin Male)

⚡ This connector supports 2 standard COM ports and 1 Parallel port. Device like printer can be connected to Parallel port ; mouse and modem etc can be connected to Serial ports.

☞ **Game /MIDI Ports**

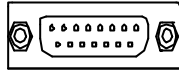

Joystick/ MIDI (15 pin Female)

☞ This connector supports joystick, MIDI keyboard and other relate audio devices.

☞ **Audio Connectors**

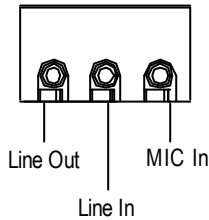

☞ After install onboard audio driver, you may connect speaker to Line Out jack, micro phone to MIC In jack. Device like CD-ROM , walkman etc can be connected to Line-In jack.

☞ **USB/LAN Connector**

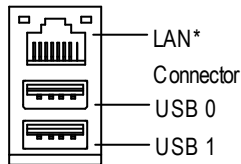

☞ Before you connect your device(s) into USB connector(s), please make sure your device(s) such as USB keyboard, mouse, scanner, zip, speaker...etc. Have a standard USB interface. Also make sure your OS (Win 95 with USB supplement, Win98, Windows 2000, Windows ME, Win NT with SP 6) supports USB controller. If your OS does not support USB controller, please contact OS vendor for possible patch or driver upgrade. For more information please contact your OS or device(s) vendors.

**\* For GA-8IRML only.**

## Connectors Introduction

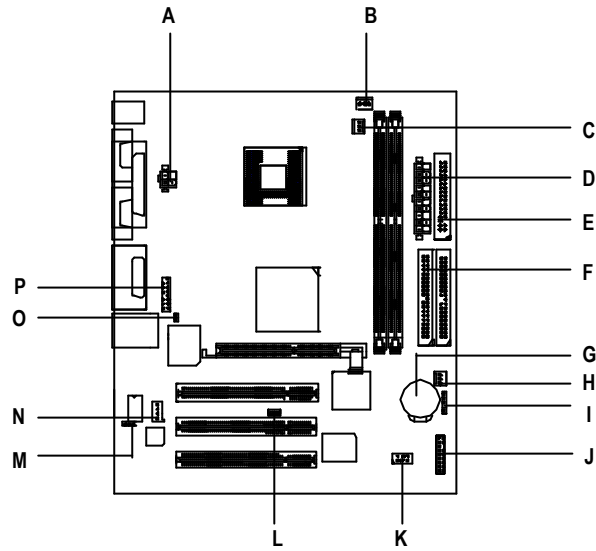

A) AUX_12V	I) IR
B) CPU_FAN	J) F_PANEL
C) PWR_FAN	K) FP_USB
D) ATX	L) WOL
E) FDD	M) LAN_EN*
F) IDE1/IDE2	N) CD_IN
G) BATTERY	O) CI
H) SYS_FAN	P) F_AUDIO

\* For GA-8IRML only.

**A) AUX\_12V ( +12V Power Connector)**

⚡ This connector (ATX +12V) supplies the CPU operation voltage (V<sub>core</sub>).  
If this " ATX+ 12V connector" is not connected, system cannot boot.

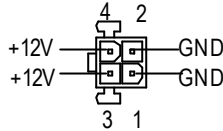

**B) CPU\_FAN (CPU FAN Connector)**

⚡ Please note, a proper installation of the CPU cooler is essential to prevent the CPU from running under abnormal condition or damaged by overheating. The CPU fan connector supports Max. current up to 600 mA.



**C) PWR\_FAN (Power FAN Connector) H) SYS\_FAN (System FAN Connector)**



**O) CI (CASE OPEN)**

⚡ This 2 pin connector allows your system to enable or disable the system alarm if the system case begins to remove.

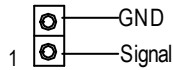

**E ) FDD (Floppy Connector)**

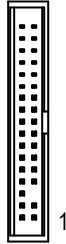

**F ) IDE1/ IDE2 (IDE1//IDE2 Connector)**

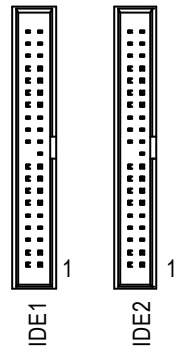

⚠ Important Notice:  
Please connect first harddisk to IDE1  
and connect CDROM to IDE2.

**K) F\_USB (Front USB Connector)**

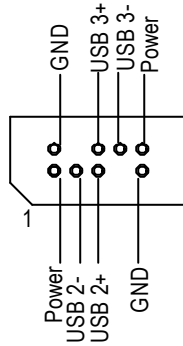

⚠ Be careful with the polarity of the front panel USB connector. Check the pin assignment while you connect the front panel USB cable. Please contact your nearest dealer for optional front panel USB cable.

**N) CD\_IN1 (CD IN)**

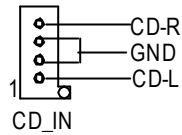

**I) IR**

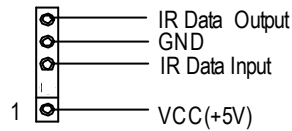

⚠ Be careful with the polarity of the IR connector while you connect the IR. Please contact your nearest dealer for optional IR device.

**P) F\_AUDIO (Front Audio Connector)**

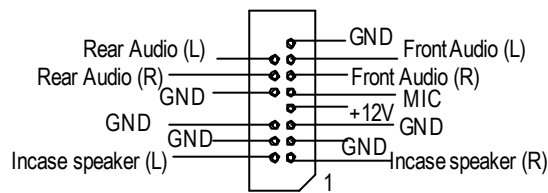

⚠ If you want to use "Front Audio" connector, you must move 11-12, 13-14 Jumper. In order to utilize the front audio header, your chassis must have front audio connector. Also please make sure the pin assignment on the cable is the same as the pin assignment on the MB header. To find out if the chassis you are buying support front audio connector, please contact your dealer.

**L) WOL (Wake on LAN)**

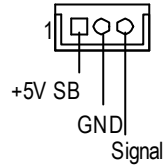

**M) LAN\_EN (Onboard LAN Function)\***

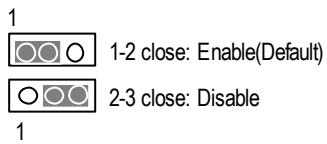

This MB supports optional LAN chip. If the MB has optional LAN chip the user can enable the LAN function by setting the "LAN\_EN" to 1-2, user can disable the optional LAN function by setting the "LAN\_EN" to 2-3. "LAN\_EN" will have any effect if the board does not have optional LAN chip.

**D) ATX (ATX Power)**

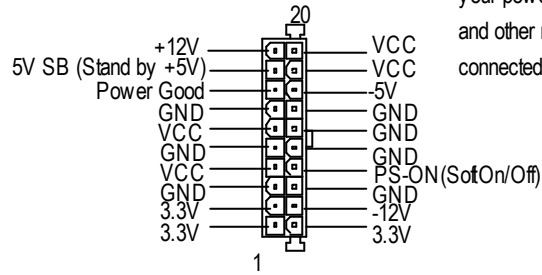

AC power cord should only be connected to your power supply unit after ATX power cable and other related devices are firmly connected to the mainboard.

\* For GA-8IRML only.



**J) F\_PANEL (2x7 pins jumper)**

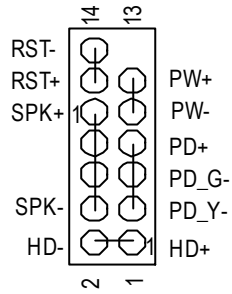

HD (IDE Hard Disk Active LED)	Pin 1: LED anode(+) Pin 2: LED cathode(-)
SPK (Speaker Connector)	Pin 1: VCC(+) Pin 2- Pin 3: NC Pin 4: Data(-)
RST (Reset Switch)	Open: Normal Operation Close: Reset Hardware System
PD+ / PD_G- / PD_Y- (Power LED)	Pin 1: LED anode(+) Pin 2: LED cathode(-) Pin 3: LED cathode(-)
PW (Soft Power Connector)	Open: Normal Operation Close: Power On/Off

⚠ Please connect the power LED, PC speaker, reset switch and power switch etc of your chassis front panel to the F\_PANEL connector according to the pin assignment above.

**G) Battery**

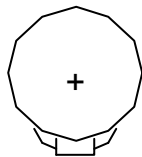

**CAUTION**

- ⚠ Danger of explosion if battery is incorrectly replaced.
- ⚠ Replace only with the same or equivalent type recommended by the manufacturer.
- ⚠ Dispose of used batteries according to the manufacturer's instructions.

## Chapter 4 Technical Reference

### Performance List

The following performance data list is the testing results of some popular benchmark testing programs. These data are just referred by users, and there is no responsibility for different testing data values gotten by users. (The different Hardware & Software configuration will result in different benchmark testing results.)

CPU	Intel Pentium®4 2GHz processor
DDR RAM	(128 x 2) MB RAM (NANYA NT5DS16M8AT-7K S)
CACHE SIZE	256KB included in CPU
DISPLAY	Gigabyte GV-GF3000D (NUCD 1.9)
STORAGE	Onboard IDE (Quantum AS30000AT 30GB)
O.S	Windows 2000+ SP2+DX 8.0a
DRIVER	Display Driver at 1024 x 768 x 64K colors x 75Hz IUCD ver. 1.9 For Intel chipset M.B.

<b>Processor</b>	Intel Pentium® 4 2GHz (100x20)
<b>WCPUID 3.0D Clock Frequency</b>	
Internal MHz	2019.88
External MHz	100.99
<b>SiSoft Sandra 2001</b>	
CPU/FPU Benchmark	3895/2484
CPU Multi-Media Benchmark	8025/9945
Drives Benchmark	20663
Memory Benchmark	1015/1073
<b>SPECviewperf 6.12</b>	
Pro CDRS-03	14.76
MedMCAD-01	30.19
Light-04	8.283
DX-06	27.13
DRV-07	18.18
Aw advs-04	62.11
<b>QUAKE III Arena (without sound)</b>	
640*480*16 Demo1	199.2
1024*768*32 Demo2	181.2
<b>3D Mark 2001 1.0</b>	6852

## Block Diagram

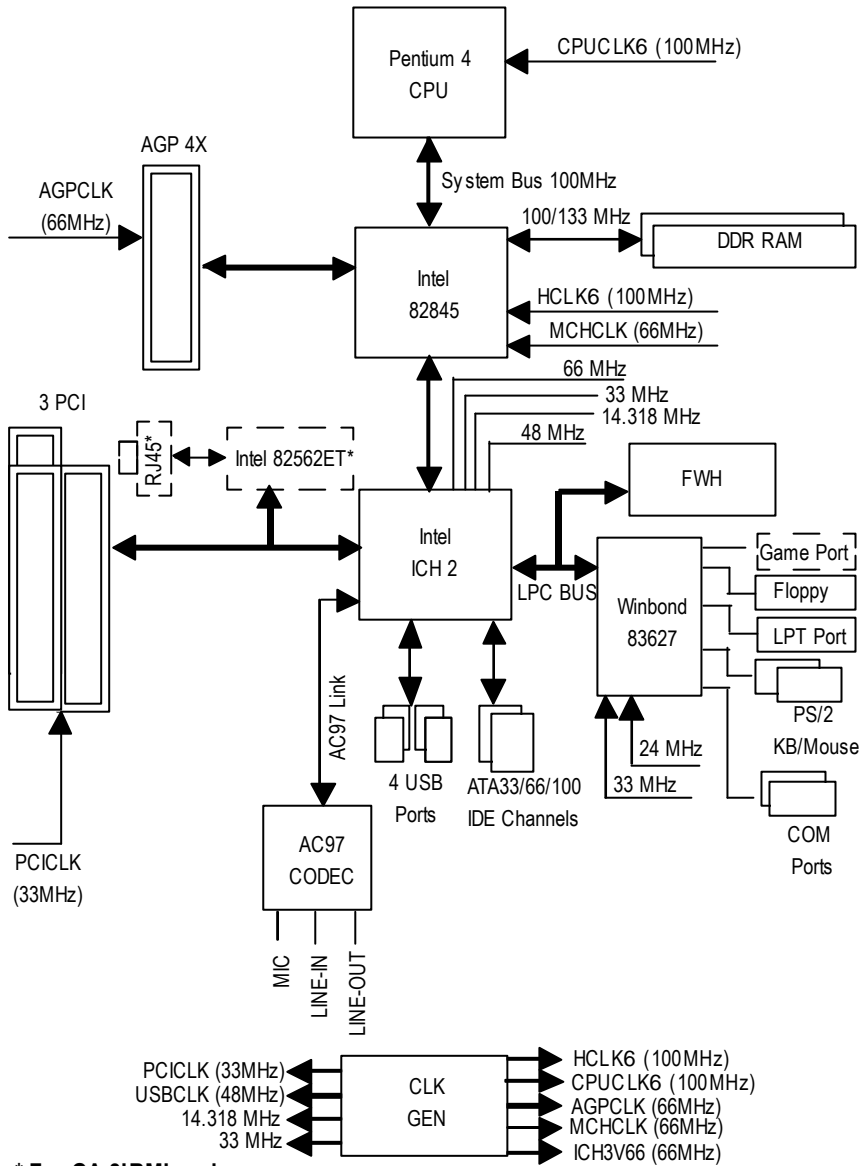

## @ BIOS Introduction

### **Gigabyte announces @ BIOS Windows BIOS live update utility**



Have you ever updated BIOS by yourself? Or like many other people, you just know what BIOS is, but always hesitate to update it? Because you think updating newest BIOS is unnecessary and actually you don't know how to update it.

Maybe not like others, you are very experienced in BIOS updating and spend quite a lot of time to do it. But of course you don't like to do it too much. First, download different BIOS from website and then switch the operating system to DOS mode. Secondly, use different flash utility to update BIOS. The above process is not a interesting job. Besides, always be carefully to store the BIOS source code correctly in your disks as if you update the wrong BIOS, it will be a nightmare.

Certainly, you wonder why motherboard vendors could not just do something right to save your time and effort and save you from the lousy BIOS updating work? Here it comes! Now Gigabyte announces @BIOS—the first Windows BIOS live update utility. This is a smart BIOS update software. It could help you to download the BIOS from internet and update it. Not like the other BIOS update software, it's a Windows utility. With the help of "@BIOS", BIOS updating is no more than a click.

Besides, no matter which mainboard you are using, if it's a Gigabyte's product\*, @BIOS help you to maintain the BIOS. This utility could detect your correct mainboard model and help you to choose the BIOS accordingly. It then downloads the BIOS from the nearest Gigabyte ftp site automatically. There are several different choices; you could use "Internet Update" to download and update your BIOS directly. Or you may want to keep a backup for your current BIOS, just choose "Save Current BIOS" to save it first. You make a wise choice to use Gigabyte, and @BIOS update your BIOS smartly. You are now worry free from updating wrong BIOS, and capable to maintain and manage your BIOS easily. Again, Gigabyte's innovative product erects a milestone in mainboard industries.

For such a wonderful software, how much it costs? Impossible! It's free! Now, if you buy a Gigabyte's motherboard, you could find this amazing software in the attached driver CD. But please remember, connected to internet at first, then you could have a internet BIOS update from your Gigabyte @BIOS.

## Easy TuneIII™ Introduction

### **Gigabyte announces EasyTuneIII Windows overdrive utility**



“Overdrive” might be one of the most common issues in computer field. But have many users ever tried it? The answer is probably “no”. Because “overdrive” is thought to be very difficult and includes a lot of technical know-how, sometimes “over-

drive” is even considered as special skills found only in some enthusiasts.

But as to the experts in “overdrive”, what’s the truth? They may spend quite a lot of time and money to study, try and use many different hardware and software tools to do “overdrive”. And even with these technologies, they still learn that it’s quite a risk because the safety and stability of an “overdrive” system is unknown.

Now everything is different because of a Windows overdrive utility EasyTuneIII—announced by Gigabyte. This utility has totally changed the gaming rule of “overdrive”. This is the first overdrive utility suitable for both normal and power users. Users can choose either “Easy Mode” or “Advanced Mode” to run “overdrive” at their convenience. For users who choose “Easy Mode”, they just need to click “Auto Optimize” to have auto and immediate CPU overclocking. This software will then overdrive CPU speed automatically with the result being shown in the control panel. If someone prefers to “overdrive” by oneself, there is also another choice. Click “Advanced Mode” to enjoy “sport drive” class overclocking. In “Advanced Mode”, one can change the system bus speed in small increments to get ultimate system performance. And no matter which motherboard is used, if it’s a Gigabyte’s product, EasyTuneIII helps to perform the best of system.

Besides, different from other traditional over-clocking methods, EasyTuneIII doesn’t require users to change neither BIOS nor hardware switch/ jumper setting; on the other hand, they can do “overdrive” at only one click. Therefore, this is a safer way for “overdrive” as nothing is changed on software or hardware. If user runs EasyTuneIII over system’s limitation, the biggest lost is only to restart the computer again and the side effect is then well controlled. Moreover, if one well-performed system speed been tested in EasyTuneIII, user can “Save” this bus speed and “Load” it in next time. Obviously, Gigabyte EasyTuneIII has already turned the “overdrive” technology toward to a newer generation.

This wonderful software is now free bundled in Gigabyte motherboard attached driver CD. Users may make a test drive of “EasyTuneIII” to find out more amazing features by themselves.

## Chapter 5 Appendix

### Picture below are shown in Windows ME (IUCD driver version 1.9)

Insert the driver CD-title that came with your motherboard into your CD-ROM driver, the driver CD-title will auto start and show the installation guide. If not, please double click the CD-ROM device icon in "My computer", and execute the setup.exe.

#### A. Installing Intel 845 Chipset Driver

Please install this driver as the first priority. this item installs the chipset driver utility that enables Plug-n-Play INF support for Intel chipset component.

#### B. Installing Sound Driver

Click this item to install sound driver.

#### C. Installing LAN Driver\*

Click this item to install LAN driver.



### Appendix A: Intel 845 Chipset Driver Installation

Follow the setup that showing on the screen to install the Utility.



A-1. Click "Windows 9x/ME/2000/XP INF Update Utility" item.

A-2. Click "Intel Ultra ATA Storage Driver" item.

\* For GA-8IRML Only.



## Appendix E: BIOS Flash Procedure

BIOS update procedure:

If your OS is Win9X, we recommend that you used Gigabyte @BIOS™ Program to flash BIOS.

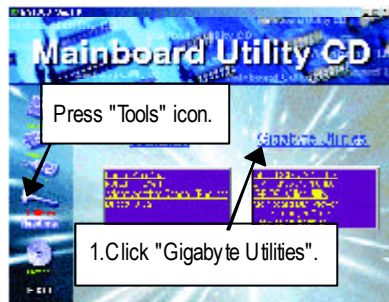

(1)

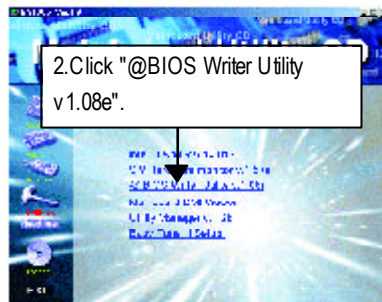

(2)

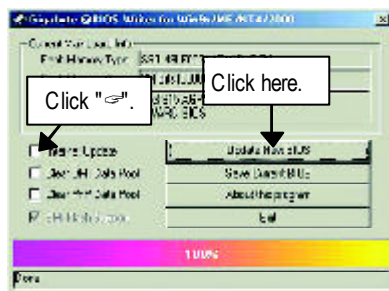

(3)

Methods and steps:

- I. Update BIOS through Internet
  - a. Click "Internet Update" icon
  - b. Click "Update New BIOS" icon
  - c. Select @BIOS™ sever ("Gigabyte @BIOS™ sever 1 in Taiwan" and "Gigabyte @BIOS™ sever 2 in Taiwan" are available for now, the others will be completed soon)
  - d. Select the exact model name on your motherboard
  - e. System will automatically download and update the BIOS.



II. Update BIOS NOT through Internet:

- a. Do not click "Internet Update" icon
- b. Click "Update New BIOS"
- c. Please select "All Files" in dialog box while opening the old file.
- d. Please search for BIOS unzip file, downloading from internet or any other methods (such as: 8IRX.F1).
- e. Complete update process following the instruction.

III. Save BIOS

In the very beginning, there is "Save Current BIOS" icon shown in dialog box. It means to save the current BIOS version.

IV. Check out supported motherboard and Flash ROM:

In the very beginning, there is "About this program" icon shown in dialog box. It can help you check out which kind of motherboard and which brand of Flash ROM are supported.

Note:

- a. In method I, if it shows two or more motherboard's model names to be selected, please make sure your motherboard's model name again. Selecting wrong model name will cause the system unbooted.
- b. In method II, be sure that motherboard's model name in BIOS unzip file are the same as your motherboard's. Otherwise, your system won't boot.
- c. In method I, if the BIOS file you need cannot be found in @BIOS™ server, please go onto Gigabyte's web site for downloading and updating it according to method II.
- d. Please note that any interruption during updating will cause system unbooted

We use GA-7VTX motherboard and Flash841 BIOS flash utility as example.

Please flash the BIOS according to the following procedures if you are now under the DOS mode.

Flash BIOS Procedure:

STEP 1:

- (1) Please make sure you have set "Auto" for BIOS Feature Setup (BIOS Flash Protection). For more detail please refer to page 32.
- (2) Please make sure your system has installed the extraction utility such as winzip or pkunzip.  
Firstly you have to install the extraction utility such as winzip or pkunzip for unzip the files. Both of these utilities are available on many shareware download pages like <http://www.shareware.cnet.com>

STEP 2: Make a DOS boot diskette. (See example: Windows 98 O.S.)

Beware: Windows ME/2000 are not allowed to make a DOS boot diskette.

- (1) With an available floppy disk in the floppy drive. Please leave the diskette "UN-write protected" type. Double click the "My Computer" icon from Desktop, then click "3.5 diskette (A)" and right click to select "Format (M)"

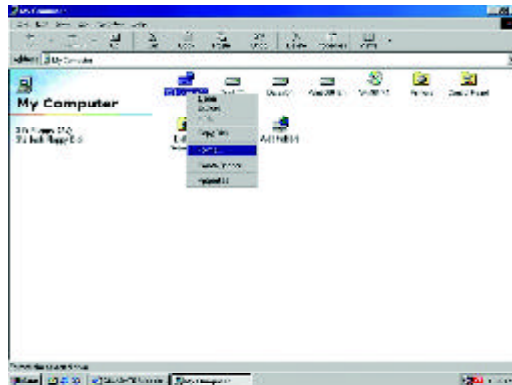

- (2) Select the "Quick (erase)" for Format Type, and pick both "Display summary when finished" and "Copy system files", after that press "Start". That will format the floppy and transfer the needed system files to it.

Beware: This procedure will erase all the prior data on that floppy, so please proceed accordingly.

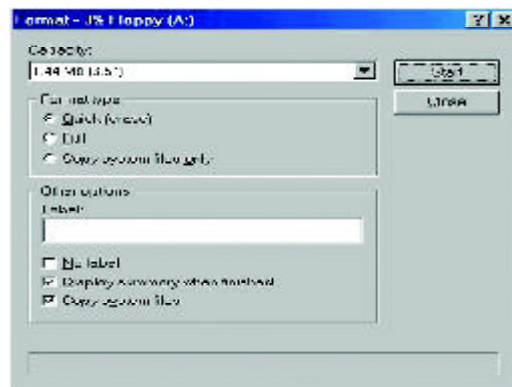

- (3) After the floppy has been formatted completely, please press "Close".



STEP 3: Download BIOS and BIOS utility program.

(1) Please go to Gigabyte website <http://www.gigabyte.com.tw/index.html>, and click "Support".



(2) From Support zone, click the "Motherboards BIOS & Drivers".

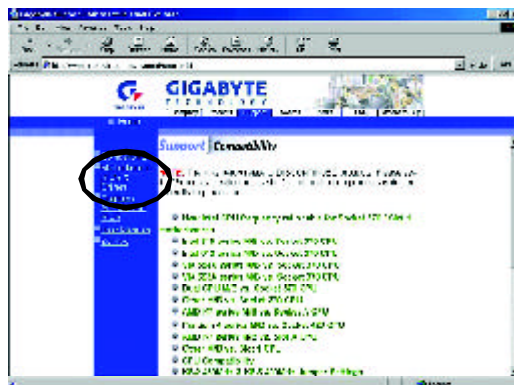

- (3) We use GA-7VTX motherboard as example. Please select GA-7VTX by Model or Chipset optional menu to obtain BIOS flash files.

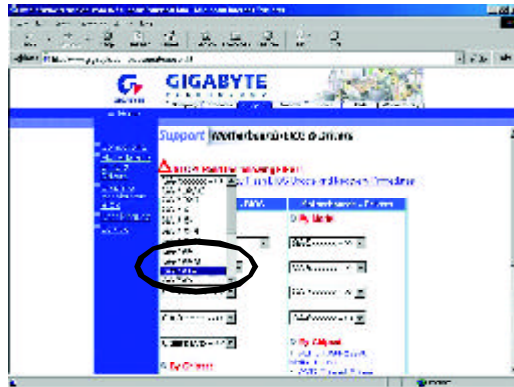

- (4) Select an appropriate BIOS version (For example: F4), and click to download the file. It will pop up a file download screen, then select the "Open this file from its current location" and press "OK".

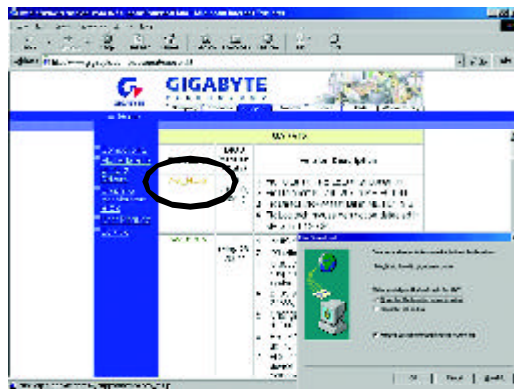

(5) At this time the screen shows the following picture, please click "Extract" button to unzip the files.



(6) Please extract the download files into the clean bootable floppy disk A mentioned in STEP 2, and press "Extract".

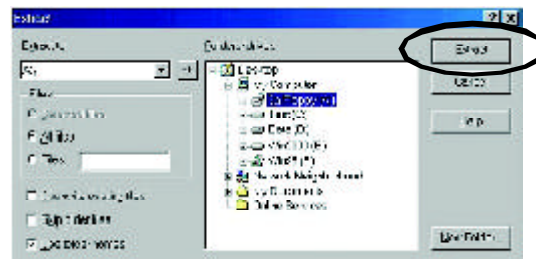

STEP 4: Make sure the system will boot from the floppy disk.

- (1) Insert the floppy disk (contains bootable program and unzip file) into the floppy drive A. Then, restart the system. The system will boot from the floppy disk. Please press <DEL> key to enter BIOS setup main menu when system is boot up.



- (2) Once you enter the BIOS setup utility, the main menu will appear on the screen. Use the arrows to highlight the item "BIOS FEATURES SETUP".

AMIBIOS SIMPLE SETUP UTILITY - VERSION 1.24b (C) 1999 American Megatrends, Inc. All Rights Reserved	
STANDARD CMOS SETUP <b>BIOS FEATURES SETUP</b> CHIPSET FEATURES SETUP POWER MANAGEMENT SETUP PNP / PCI CONFIGURATION LOAD BIOS DEFAULTS LOAD SETUP DEFAULTS	INTEGRATED PERIPHERALS HARDWARE MONITOR & MISC SETUP SUPERVISOR PASSWORD USER PASSWORD IDE HDD AUTO DETECTION SAVE & EXIT SETUP EXIT WITHOUT SAVING
ESC: Quit      ↓↓↓↓↓ : Select Item      (Shift)F2 : Change Color      F5: Old Values F6: Load BIOS Defaults      F7: Load Setup Defaults      F10: Save & Exit	
Time, Date , Hard Disk Type...	

- (3) Press "Enter" to enter "BIOS FEATURES SETUP" menu. Use the arrows to highlight the item "1st Boot Device", and then use the "Page Up" or "Page Down" keys to select "Floppy".

AMIBIOS SETUP - BIOS FEATURES SETUP	
(C) 2001 American Megatrends, Inc. All Rights Reserved	
1st Boot Device : Floppy	ESC: Quit      ↑↑↑↑ : Select Item F1 : Help      PU/PD/+/- : Modify F5 : Old Values (Shift)F2: Color F6 : Load BIOS Defaults F7 : Load Setup Defaults
2nd Boot Device : IDE-0	
3rd Boot Device : CDROM	
S.M.A.R.T. for Hard Disks : Disabled	
BootUp Num-Lock : On	
Floppy Drive Seek : Disabled	
Password Check : Setup	

- (4) Press "ESC" to go back to previous screen. Use the arrows to highlight the item "SAVE & EXIT SETUP" then press "Enter". System will ask "SAVE to CMOS and EXIT (Y/N)?" Press "Y" and "Enter" keys to confirm. Now the system will reboot automatically, the new BIOS setting will be taken effect next boot-up.

AMIBIOS SIMPLE SETUP UTILITY - VERSION 1.24b	
(C) 2001 American Megatrends, Inc. All Rights Reserved	
STANDARD CMOS SETUP	INTEGRATED PERIPHERALS
BIOS FEATURES SETUP	HARDWARE MONITOR & MISC SETUP
CHIPSET FEATURES SETUP	SUPERVISOR PASSWORD
POWER MANAGEMENT SETUP	USER PASSWORD
PNP / PCI CONF	Save to CMOS and EXIT (Y/N)? Y
LOAD BIOS DEFAULTS	SAVE & EXIT SETUP
LOAD SETUP DEFAULTS	EXIT WITHOUT SAVING
ESC: Quit      ↑↑↑↑↑ : Select Item      (Shift)F2 : Change Color      F5: Old Values F6: Load BIOS Defaults      F7: Load Setup Defaults      F10: Save & Exit	
Save Data to CMOS & Exit SETUP	



STEP 5: BIOS flashing.

- (1) After the system boot from floppy disk, type "A:\> dir/w" and press "Enter" to check the entire files in floppy A. Then type the "BIOS flash utility" and "BIOS file" after A:\>. In this case you have to type "A:\> Flash841 7VTX.F4" and then press "Enter".

```
Starting Windows 98...

Microsoft(R) Windows98
  © Copyright Microsoft Corp 1981-1999

A:\> dir/w
  Volume in drive A has no label
Volume Serial Number is 16EB-353D
Directory of A:\
COMMAND.COM    7VTX.F4  FLASH841.EXE
               3 file(s)  838,954 bytes
               0 dir(s)   324,608 bytes free

A:\> Flash841 7VTX.F4
```

- (2) Now screen appears the following Flash Utility main menu. Press "Enter", the highlighted item will locate on the model name of the right-upper screen. Right after that, press "Enter" to start BIOS Flash Utility.

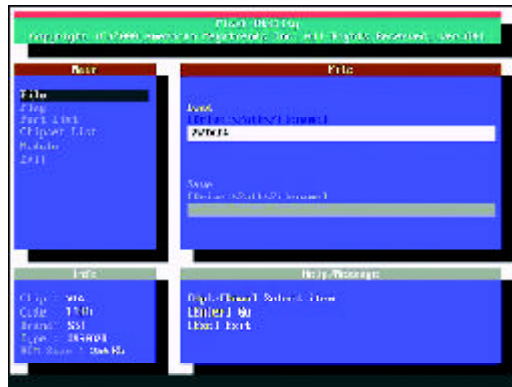



STEP 6: Load BIOS defaults.

Normally the system redetects all devices after BIOS has been upgraded. Therefore, we highly recommend reloading the BIOS defaults after BIOS has been upgraded. This important step resets everything after the flash.

- (1) Take out the floppy diskette from floppy drive, and then restart the system. The boot up screen will indicate your motherboard model and current BIOS version.

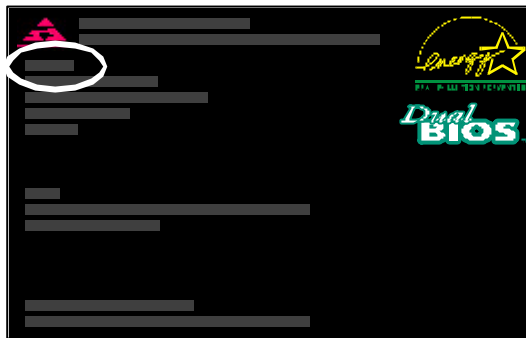

- (2) Don't forget to press <DEL> key to enter BIOS setup again when system is boot up. Use the arrows to highlight the item "LOAD SETUP DEFAULTS" then press "Enter". System will ask "Load Setup Defaults (Y/N)?" Press "Y" and "Enter" keys to confirm.

AMIBIOS SIMPLE SETUP UTILITY - VERSION 1.24b (C) 2001 American Megatrends, Inc. All Rights Reserved	
STANDARD CMOS SETUP	INTEGRATED PERIPHERALS
BIOS FEATURES SETUP	HARDWARE MONITOR & MISC SETUP
CHIPSET FEATURES SETUP	SUPERVISOR PASSWORD
POWER MANAGEMENT SETUP	USER PASSWORD
PNP / PCI CONFIGURATION	Load Setup Defaults? (Y/N)?N
LOAD BIOS DEFAULTS	SAVE & EXIT SETUP
LOAD SETUP DEFAULTS	EXIT WITHOUT SAVING
ESC: Quit    ↑ ↓ ← → : Select Item    (Shift)F2 : Change Color    F5: Old Values F6: Load BIOS Defaults    F7: Load Setup Defaults    F10: Save & Exit	
Load Setup Defaults	

- (3) Use the arrows to highlight the item "SAVE & EXIT SETUP" and press "Enter". System will ask "SAVE to CMOS and EXIT (Y/N)?" Press "Y" and "Enter" keys to confirm. Now the system will reboot automatically, the new BIOS setting will be taken effect next boot-up.

AMIBIOS SIMPLE SETUP UTILITY - VERSION 1.24b (C) 2001 American Megatrends, Inc. All Rights Reserved	
STANDARD CMOS SETUP	INTEGRATED PERIPHERALS
BIOS FEATURES SETUP	HARDWARE MONITOR & MISC SETUP
CHIPSET FEATURES SETUP	SUPERVISOR PASSWORD
POWER MANAGEMENT SETUP	USER PASSWORD
PNP / PCI CONF	SAVE & EXIT SETUP
LOAD BIOS DEFAULTS	EXIT WITHOUT SAVING
LOAD SETUP DEFAULTS	
ESC: Quit      ↑↑↑↑ : Select Item      (Shift)F2 : Change Color      F5: Old Values F6: Load BIOS Defaults      F7: Load Setup Defaults      F10: Save & Exit	
Save Data to CMOS & Exit SETUP	

- (4) Congratulate you have accomplished the BIOS flash procedure.

**Appendix G: Acronyms**

Acronyms	Meaning
ACPI	Advanced Configuration and Power Interface
APM	Advanced Power Management
AGP	Accelerated Graphics Port
AMR	Audio Modem Riser
ACR	Advanced Communications Riser
BIOS	Basic Input / Output System
CPU	Central Processing Unit
CMOS	Complementary Metal Oxide Semiconductor
CRIMM	Continuity RIMM
CNR	Communication and Networking Riser
DMA	Direct Memory Access
DMI	Desktop Management Interface
DIMM	Dual Inline Memory Module
DRM	Dual Retention Mechanism
DRAM	Dynamic Random Access Memory
DDR	Double Data Rate
ECP	Extended Capabilities Port
ESCD	Extended System Configuration Data
ECC	Error Checking and Correcting
EMC	Electromagnetic Compatibility
EPP	Enhanced Parallel Port
ESD	Electrostatic Discharge
FDD	Floppy Disk Device
FSB	Front Side Bus
HDD	Hard Disk Device
IDE	Integrated Dual Channel Enhanced
IRQ	Interrupt Request
I/O	Input / Output
IOAPIC	Input Output Advanced Programmable Input Controller
ISA	Industry Standard Architecture
LAN	Local Area Network

to be continued.....

---

Acronyms	Meaning
LBA	Logical Block Addressing
LED	Light Emitting Diode
MHz	Megahertz
MIDI	Musical Interface Digital Interface
MTH	Memory Translator Hub
MPT	Memory Protocol Translator
NIC	Network Interface Card
OS	Operating System
OEM	Original Equipment Manufacturer
PAC	PCI A.G.P. Controller
POST	Power-On Self Test
PCI	Peripheral Component Interconnect
RIMM	Rambus in-line Memory Module
SCI	Special Circumstance Instructions
SECC	Single Edge Contact Cartridge
SRAM	Static Random Access Memory
SMP	Symmetric Multi-Processing
SMI	System Management Interrupt
USB	Universal Serial Bus
VID	Voltage ID

---

**Technical Support/RMA Sheet**

Customer/Country:	Company:	Phone No.:
Contact Person:	E-mail Add. :	

Model name/Lot Number:	PCB revision:
BIOS version:	O.S./A.S.:

Hardware Configuration	Mfs.	Model name	Size:	Driver/Utility:
CPU				
Memory Brand				
Video Card				
Audio Card				
HDD				
CD-ROM / DVD-ROM				
Modem				
Network				
AMR / CNR				
Keyboard				
Mouse				
Power supply				
Other Device				

Problem Description:

\_\_\_\_\_

\_\_\_\_\_