

GA-8ITX Series  
P4 Titan-RDRAM Motherboard

# USER'S MANUAL

Pentium®4 Processor Motherboard  
Rev. 1.1 Second Edition  
12ME-8ITX-1102



When you installing AGP card, please make sure the following notice is fully understood and practiced. If your AGP card has "AGP 4X notch"(show below), please make sure your AGP card is AGP 4X (1.5V).



**Do not use AGP 2X card (3.3V) in this motherboard. It will burn and damage the motherboard due to Intel® 850 chipset can't support AGP 2X(3.3V).**

Example 1: Diamond Vipper V770 golden finger is compatible with 2X/4X mode AGP slot. It can be switched between AGP 2X (3.3V) or 4X(1.5V) mode by adjusting the jumper. The factory default for this card is 2X(3.3V). If you install this card in GA-8ITX series (or any AGP 4X only) motherboards without switching the jumper to 4X mode (1.5V), it will burn the motherboard.

Example 2: ATi Rage 128 Pro (Power Color) & SiS 305 golden finger is compatible with 2X/4X mode AGP slot, but it supports 2X(3.3V) only. If you install this card in GA-8ITX series (or any AGP 4X only) motherboards, it will burn the motherboard.



- The author assumes no responsibility for any errors or omissions that may appear in this document nor does the author make a commitment to update the information contained herein.
- Third-party brands and names are the property of their respective owners.
- Please do not remove any labels on motherboard, this may void the warranty of this motherboard.
- Due to rapid change in technology, some of the specifications might be out of date before publication of this booklet.



# DECLARATION OF CONFORMITY

Per FCC Part 2 Section 2.1077(a)



**Responsible Party Name: G.B.T. INC.**

**Address: 18305 Valley Blvd., Suite#A LA  
Puent, CA 91744**

**Phone/Fax No: (818) 854-9338/ (818) 854-9339**

hereby declares that the product

**Product Name: Motherboard**

**Model Number: GA-8ITX/GA-8ITXR**

Conforms to the following specifications:

FCC Part 15, Subpart B, Section 15.107(a) and Section 15.109(a),  
Class B Digital Device

## **Supplementary Information:**

This device complies with part 15 of the FCC Rules. Operation is subject to the following two conditions: (1) This device may not cause harmful and (2) this device must accept any inference received, including that may cause undesired operation.

Representative Person's Name: ERIC LU

Signature: Eric Lu

Date: August 20,2001

# Declaration of Conformity

We, Manufacturer/Importer  
(full address)

**G.B.T. Technology Trading GmbH**  
**Ausschlagler Weg 41, 1F, 20537 Hamburg, Germany**

declare that the product  
(description of the apparatus, system, installation to which it refers)

**Mother Board**  
GA-8ITX/GA-8ITXR  
is in conformity with

(reference to the specification under which conformity is declared)  
in accordance with 89/336 EEC-EMC Directive

- |   |  |  |  |
|---|--|--|--|
| <input type="checkbox"/> EN 55011   | Limits and methods of measurement of radio disturbance characteristics of industrial, scientific and medical (ISM) high frequency equipment                | <input type="checkbox"/> EN 61000-3-2*<br><input checked="" type="checkbox"/> EN 60555-2             | Disturbances in supply systems cause by household appliances and similar electrical equipment "Harmonics"  |
| <input type="checkbox"/> EN 55013   | Limits and methods of measurement of radio disturbance characteristics of broadcast receivers and associated equipment                                     | <input type="checkbox"/> EN 61000-3-3*<br><input checked="" type="checkbox"/> EN 60555-3             | Disturbances in supply systems cause by household appliances and similar electrical equipment "Voltage fluctuations"   |
| <input type="checkbox"/> EN 55014   | Limits and methods of measurement of radio disturbance characteristics of household electrical appliances, portable tools and similar electrical apparatus | <input checked="" type="checkbox"/> EN 50081-1<br><br><input checked="" type="checkbox"/> EN 50082-1 | Generic emission standard Part 1:<br>Residual commercial and light industry<br><br>Generic immunity standard Part 1:<br>Residual commercial and light industry |
| <input type="checkbox"/> EN 55015   | Limits and methods of measurement of radio disturbance characteristics of fluorescent lamps and luminaries   | <input type="checkbox"/> EN 55081-2  | Generic emission standard Part 2:<br>Industrial environment  |
| <input type="checkbox"/> EN 55020   | Immunity from radio interference of broadcast receivers and associated equipment   | <input type="checkbox"/> EN 55082-2  | Generic emission standard Part 2:<br>Industrial environment  |
| <input checked="" type="checkbox"/> EN 55022  | Limits and methods of measurement of radio disturbance characteristics of information technology equipment   | <input type="checkbox"/> ENV 55104   | Immunity requirements for household appliances tools and similar apparatus   |
| <input type="checkbox"/> DIN VDE 0855<br><input type="checkbox"/> part 10<br><input type="checkbox"/> part 12 | Cabled distribution systems: Equipment for receiving and/or distribution from sound and television signals   | <input type="checkbox"/> EN50091-2   | EMC requirements for uninterruptible power systems (UPS)   |

CE marking



(EC conformity marking)

**The manufacturer also declares the conformity of above mentioned product with the actual required safety standards in accordance with LVD 73/23 EEC**

- |                                   |   |                                     |
|-----------------------------------|---|-------------------------------------|
| <input type="checkbox"/> EN 60065 | Safety requirements for mains operated electronic and related apparatus for household and similar general use | <input type="checkbox"/> EN 60950   |
| <input type="checkbox"/> EN 60335 | Safety of household and similar electrical appliances   | <input type="checkbox"/> EN 50091-1 |

**Manufacturer/Importer**

(Stamp)

Date : August 20, 2001

Signature: Rex Lin  
Name: Rex Lin

## Table Of Content

Revision History.....	4
Item Checklist .....	4
WARNING!.....	5
Chapter 1 Introduction .....	6
Summary of Features .....	6
GA-8ITX Series Motherboard Layout .....	8
Chapter 2 Hardware Installation Process .....	9
Step 1: Install the Central Processing Unit (CPU).....	10
CPU Installation .....	10
CPU Heat Sink Installation .....	11
Step 2: Install memory modules .....	12
Introduce RIMM (Rambus In-line Memory Module) .....	13
Step 3: Install expansion cards .....	14
Step 4: Connect ribbon cables, cabinet wires, and power supply .....	15
I/O Back Panel Introduction .....	15
Connectors Introduction .....	17
Jumper Setting .....	24
ATX 12V Power Supply Introduction .....	26
6 Pin Aux. Power Connector .....	26
Chapter 3 BIOS Setup .....	27
Select Language .....	29
The Main Menu (For example: BIOS Ver. :F4).....	29
Standard CMOS Features.....	31

---

BIOS Features Setup .....	34
Chipset Features Setup .....	36
Power Management Setup .....	39
PNP/PCI Configuration .....	43
Load Fail-Safe Defaults .....	45
Load Optimized Defaults .....	46
Integrated Peripherals .....	47
Hardware Monitor & MISC Setup .....	53
Set Supervisor / User Password .....	55
IDE HDD Auto Detection .....	56
Save & Exit Setup .....	57
Exit Without Saving .....	58
Chapter 4 Technical Reference .....	59
Performance List .....	59
Block Diagram .....	60
Dual BIOS Introduction (For GA-8ITXR Only) .....	61
Four Speaker & SPDIF Introduction(For GA-8ITXR Only) .....	69
@ BIOS Introduction .....	73
Easy Tunell™ Introduction .....	74
RAID Introduction(For GA-8ITXR Only) .....	75
Chapter 5 Appendix .....	98

## Revision History

Revision	Revision Note	Date
1.0	Initial release of the GA-8ITX Series motherboard user's manual.	Aug.2001
1.1	Initial release of the GA-8ITX Series motherboard user's manual.	Sep.2001
1.1	Second release of the GA-8ITX Series motherboard user's manual.	Sep.2001

## Item Checklist

- The GA-8ITX Series motherboard
- IDE cable x 1 or x 3\*
- Floppy cable x 1
- USB cable x 1
- CD for motherboard driver & utility (IUCD)
- GA-8ITX Series user's manual
- I/O Shield
- Quick PC Installation Guide
- CRIMM x 2

\*\*\* For GA-8ITXR only.



---

**WARNING!**

Computer motherboards and expansion cards contain very delicate Integrated Circuit (IC) chips. To protect them against damage from static electricity, you should follow some precautions whenever you work on your computer.

1. Unplug your computer when working on the inside.
2. Use a grounded wrist strap before handling computer components. If you do not have one, touch both of your hands to a safely grounded object or to a metal object, such as the power supply case.
3. Hold components by the edges and try not touch the IC chips, leads or connectors, or other components.
4. Place components on a grounded antistatic pad or on the bag that came with the components whenever the components are separated from the system.
5. Ensure that the ATX power supply is switched off before you plug in or remove the ATX power connector on the motherboard.

**Installing the motherboard to the chassis...**

If the motherboard has mounting holes, but they don't line up with the holes on the base and there are no slots to attach the spacers, do not become alarmed you can still attach the spacers to the mounting holes. Just cut the bottom portion of the spacers (the spacer may be a little hard to cut off, so be careful of your hands). In this way you can still attach the motherboard to the base without worrying about short circuits. Sometimes you may need to use the plastic springs to isolate the screw from the motherboard PCB surface, because the circuit wire may be near by the hole. Be careful, don't let the screw contact any printed circuit write or parts on the PCB that are near the fixing hole, otherwise it may damage the board or cause board malfunctioning.

# Chapter 1 Introduction

## Summary of Features

---

Form Factor	<ul style="list-style-type: none"><li>• 30.5cm x 24.5cm ATX size form factor, 6 layers PCB.</li></ul>
Motherboard	<ul style="list-style-type: none"><li>• GA-8ITX Series Motherboard: GA-8ITX and GA-8ITXR</li></ul>
CPU	<ul style="list-style-type: none"><li>• Socket 478 for Intel® Micro FC-PGA2 Pentium® 4 processor</li><li>• Intel Pentium®4 400MHz FSB</li><li>• 2nd Level cache depend on CPU</li></ul>
Chipset	<ul style="list-style-type: none"><li>• Chipset 82850 HOST/AGP/Controller</li><li>• 82801BA(ICH2) I/O Controller Hub</li></ul>
Memory	<ul style="list-style-type: none"><li>• 4 184-pin RIMM Sockets</li><li>• Dual direct RDRAM channel</li><li>• Supports up to 2GB (Max)</li></ul>
I/O Control	<ul style="list-style-type: none"><li>• Winbond W83627HF</li></ul>
Slots	<ul style="list-style-type: none"><li>• 1 CNR(Communication and Networking Riser) Slot</li><li>• 1 AGP support 4X(1.5V) device</li><li>• 6 PCI slot supports 33MHz &amp; PCI 2.2 compliant</li></ul>
On-Board IDE	<ul style="list-style-type: none"><li>• An IDE controller on the Intel 82801BA PCI chipset provides IDE HDD/CD-ROM with PIO, Bus Master (Ultra DMA33/ATA66/ATA100) operation modes.</li><li>• Can connect up to four IDE devices</li></ul>
On-Board Peripherals	<ul style="list-style-type: none"><li>• 1 Floppy port supports 2 FDD with 360K, 720K, 1.2M, 1.44M and 2.88M bytes.</li><li>• 1 Parallel port supports Normal/EPP/ECP mode</li><li>• 2 Serial ports (COMA&amp;COMB)</li><li>• 4 USB ports (Rear USB x 2, Front USB x 2)</li><li>• 1 IrDA connector for IR/CIR</li></ul>
Hardware Monitor	<ul style="list-style-type: none"><li>• CPU/Power/System Fan Revolution detect</li><li>• CPU Overheat Warning</li><li>• System Voltage Detect</li></ul>

---

to be continued.....

On-Board LAN	<ul style="list-style-type: none"> <li>• Build in RTL8100(B)L Chipset *</li> </ul>
On-Board Sound	<ul style="list-style-type: none"> <li>• Creative CT5880 Sound Chipset *</li> <li>• 2/4* channel audio CODEC</li> <li>• Line In/Line Out/Mic In/CD In/Game Port/AUX IN*/TEL*</li> </ul>
On-Board RAID*	<ul style="list-style-type: none"> <li>• Support data striping (RAID 0) or mirroring (RAID 1)</li> <li>• Supports concurrent dual IDE controller operation</li> <li>• Supports IDE bus master operation</li> <li>• Displays status and error checking messages during boot-up</li> <li>• Mirroring supports automatic background rebuilds</li> <li>• Features LBA and Extended Interrupt13 drive translation in controller onboard BIOS</li> </ul>
PS/2 Connector	<ul style="list-style-type: none"> <li>• PS/2 Keyboard interface and PS/2 Mouse interface</li> </ul>
BIOS	<ul style="list-style-type: none"> <li>• Licensed AMI BIOS, 4M bit FWH</li> <li>• Supports Dual BIOS *</li> </ul>
Additional Features	<ul style="list-style-type: none"> <li>• PS/2 Keyboard power on by password</li> <li>• PS/2 Mouse power on</li> <li>• External Modem wake up</li> <li>• STR(Suspend-To-RAM)</li> <li>• Wake on LAN</li> <li>• AC Recovery</li> <li>• USB KB/Mouse wake up from S3</li> <li>• Supports @BIOS</li> <li>• Supports EasyTuneIII</li> <li>• Supports Multi Language</li> </ul>
Special Features	<ul style="list-style-type: none"> <li>• Over Voltage (RIMM/AGP/CPU)*</li> <li>• Over Clock (CPU/PCI/AGP)*</li> </ul>

- ☛ Please set the CPU host frequency in accordance with your processor's specifications. We don't recommend you to set the system bus frequency over the CPU's specification because these specific bus frequencies are not the standard specifications for CPU, chipset and most of the peripherals. Whether your system can run under these specific bus frequencies properly will depend on your hardware configurations, including CPU, Chipsets, SDRAM, Cards....etc.

\*\*\*\* For GA-8ITX only .

\*\*\*\* For GA-8ITXR only.

# GA-8ITX Series Motherboard Layout

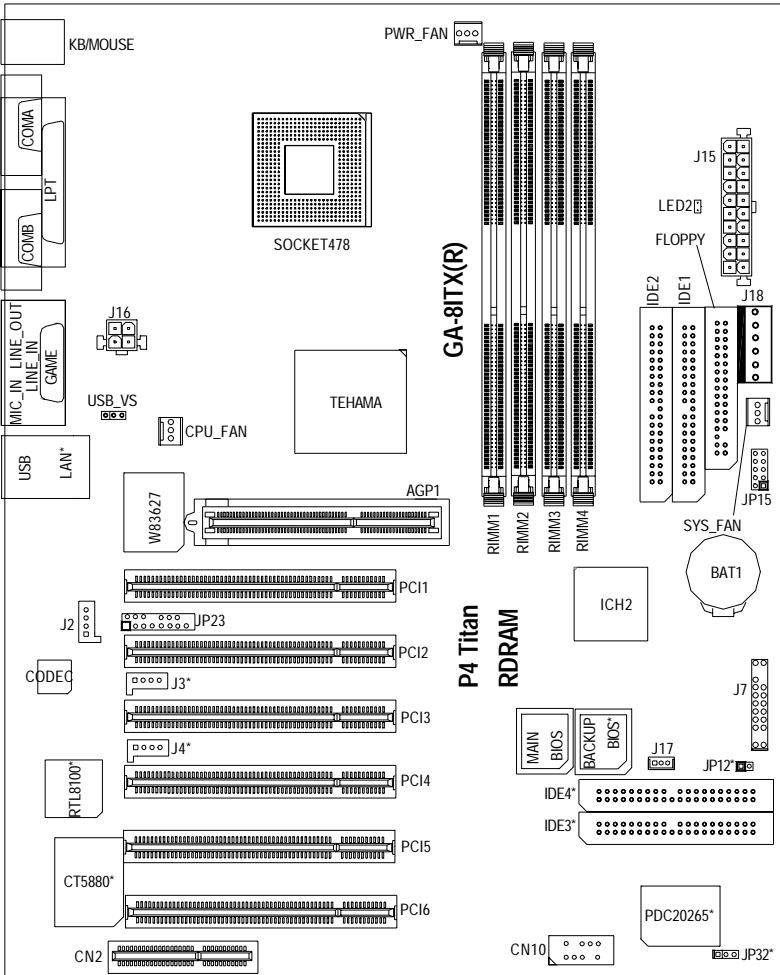

\*\*\* For GA-8ITXR only.

## Chapter 2 Hardware Installation Process

To set up your computer, you must complete the following setups:

- Step 1- Install the Central Processing Unit (CPU)
- Step 2- Install memory modules
- Step 3- Install expansion cards
- Step 4- Connect ribbon cables, cabinet wires, and power supply
- Step 5- Setup BIOS software
- Step 6- Install supporting software tools

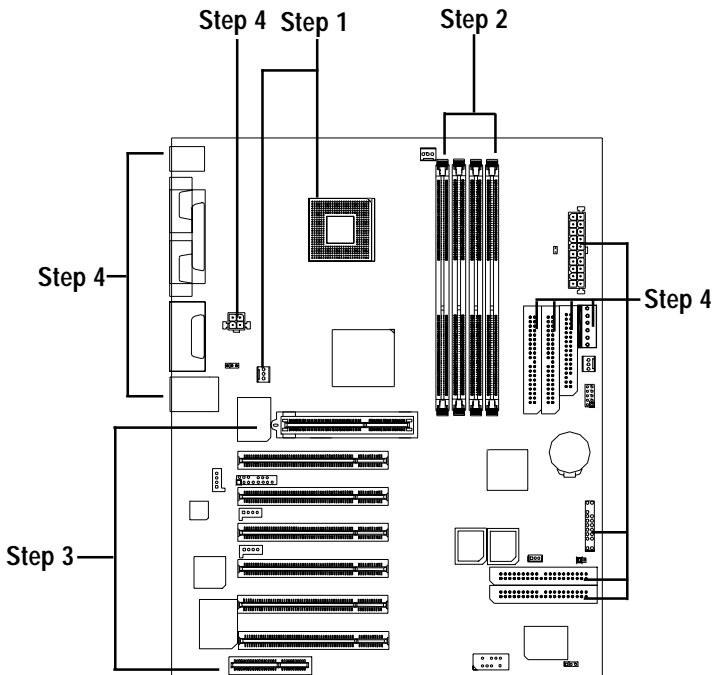

## Step 1: Install the Central Processing Unit (CPU)

### CPU Installation



CPU Top View

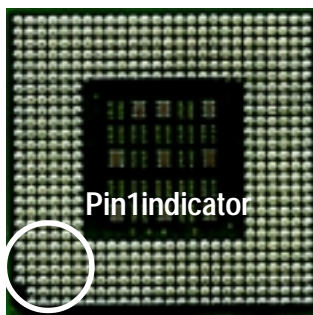

CPU Bottom View

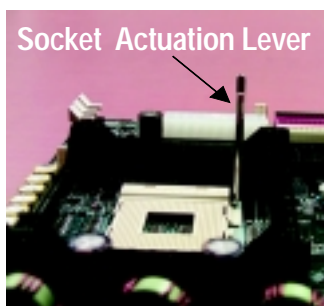

1. Pull up the CPU socket level and up to 90-degree angle.



2. Locate Pin 1 in the socket and look for a (golden) cut edge on the CPU upper corner. Then insert the CPU into the socket.

3. Press down the CPU socket lever and finish CPU installation.

⚠ Please make sure the CPU type is supported by the motherboard.

## CPU Heat Sink Installation



1. Fasten the heatsink supporting-base onto the CPU socket on the main-board.

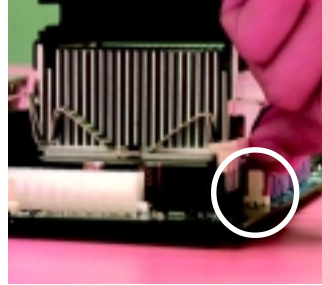

2. Make sure the CPU fan is plugged to the CPU fan connector, than install complete.

- Please use Intel approved cooling fan.
- We recommend you to apply the thermal tape to provide better heat conduction between your CPU and heatsink.  
(The CPU cooling fan might stick to the CPU due to the hardening of the thermal paste. During this condition if you try to remove the cooling fan, you might pull the processor out of the CPU socket along with the cooling fan, and might damage the processor. To avoid this from happening, we suggest you to either use thermal tape instead of thermal paste, or remove the cooling fan with extreme caution.)
- Make sure the CPU fan power cable is plugged in to the CPU fan connector, this completes the installation.
- Please refer to CPU heat sink user's manual for more detail installation procedure.

## Step 2: Install memory modules

The motherboard has 4 Rambus In-line Memory Module (RIMM) sockets. The BIOS will automatically detect memory type and size. To install the memory module, just push it vertically into the RIMM Slot. The RIMM module can only fit in one direction due to the two notches. Please note; Both RIMM modules inserted on RIMM1 and RIMM2 slots are recommended to have the same size, frequency. If not, the larger sized module will be automatically re-sized by BIOS to match the smaller sized module. The same rule applies to both RIMM3 and RIMM4 slots. You can insert two RIMMs or four RIMMs into RIMM slots, but C-RIMM (Continuity RIMM) modules must be inserted into the empty slots.

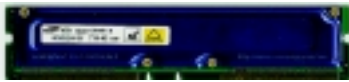

**RIMM**



**CRIMM**

Check RIMM module if it is supported by the M/B.

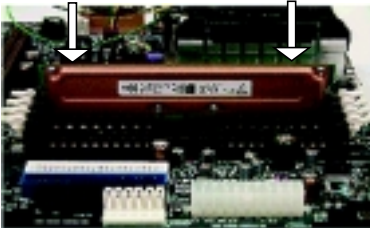

Insert the RIMM module into the slot.



Push the ejector tab towards the RIMM.

●<sup>※</sup> When STR/RIMM LED is ON, you do not install / remove RDRAM from socket.



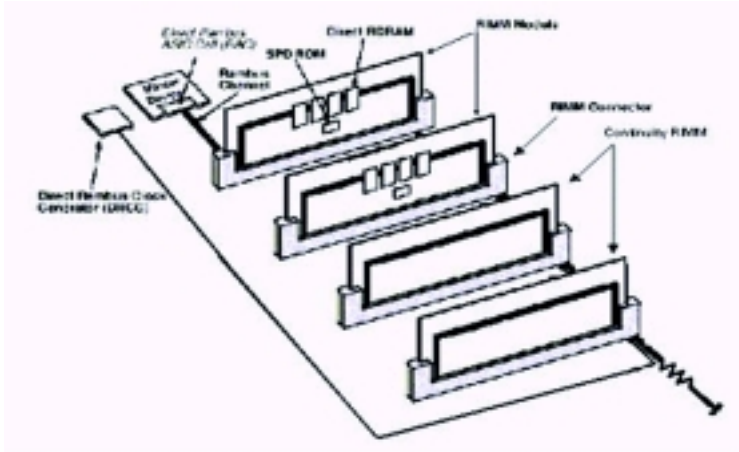

## Introduce RIMM (Rambus In-line Memory Module)

Direct Rambus Memory Controller

⇒ Directly support a Dual Direct Rambus \* Channel

- ◆ Supports 300&400 MHz Direct Rambus \* Channel @ 100MHz host bus frequency.
- ◆ Maximum memory array size up to 256MB using 64Mb/72Mb, 512MB using 128Mb/144Mb, 1GB using 256Mb/288Mb DRAM technology

⇒ Supports up to 32 Direct Rambus devices per channel

⇒ Supports a maximum DRAM address decode space of 4GB

⇒ Configurable optional ECC operation

- ◆ ECC with single bit Error Correction and multiple bit Error Detection
- ◆ Single bit errors corrected and written back to memory (auto-scrubbing)
- ◆ Parity mode not supported

APIC memory space in hardware. It is the BIOS or system designer's responsibility to limit DRAM population so that adequate PCI, AGP, High BIOS, and APIC memory space can be allocated.

## Step 3: Install expansion cards

1. Read the related expansion card's instruction document before install the expansion card into the computer.
2. Remove your computer's chassis cover, necessary screws and slot bracket from the computer.
3. Press the expansion card firmly into expansion slot in motherboard.
4. Be sure the metal contacts on the card are indeed seated in the slot.
5. Replace the screw to secure the slot bracket of the expansion card.
6. Replace your computer's chassis cover.
7. Power on the computer, if necessary, setup BIOS utility of expansion card from BIOS.
8. Install related driver from the operating system.



- **When you try to install VGA Card, please note that the motherboard only support AGP 4X(1.5V) VGA Card.**

## Step 4: Connect ribbon cables, cabinet wires, and power supply

### I/O Back Panel Introduction

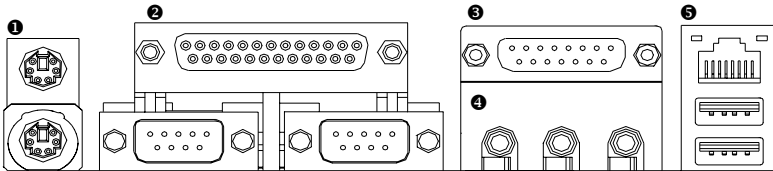

#### 1 PS/2 Keyboard and PS/2 Mouse Connector

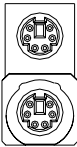

PS/2 Mouse Connector  
(6 pin Female)

PS/2 Keyboard Connector  
(6 pin Female)

➤ This connector supports standard PS/2 keyboard and PS/2 mouse.

#### 2 Parallel Port and Serial Ports (COMA/COMB)

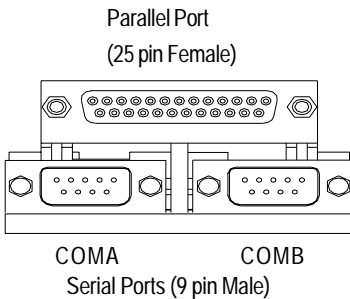

Parallel Port  
(25 pin Female)

COMA      COMB  
Serial Ports (9 pin Male)

➤ This connector supports 2 standard COM ports and 1 Parallel port. Device like printer can be connected to Parallel port ; mouse and modem etc can be connected to Serial ports.

### 3 Game /MIDI Ports

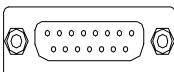

Joystick/ MIDI (15 pin Female)

- This connector supports joystick, MIDI keyboard and other relate audio devices.

### 4 Audio Connectors

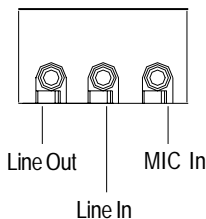

- After install onboard audio driver, you may connect speaker to Line Out jack, micro phone to MIC In jack. Device like CD-ROM , walkman etc can be connected to Line-In jack.

### 5 USB/LAN Connector

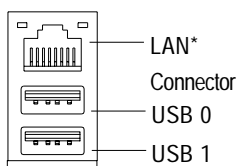

- Before you connect your device(s) into USB connector(s), please make sure your device(s) such as USB keyboard, mouse, scanner, zip, speaker..etc. Have a standard USB interface. Also make sure your OS (Win 95 with USB supplement, Win98, Windows 2000, Windows ME, Win NT with SP 6) supports USB controller. If your OS does not support USB controller, please contact OS vendor for possible patch or driver upgrade. For more information please contact your OS or device(s) vendors.

\*\*\* For GA-8ITXR only.

## Connectors Introduction

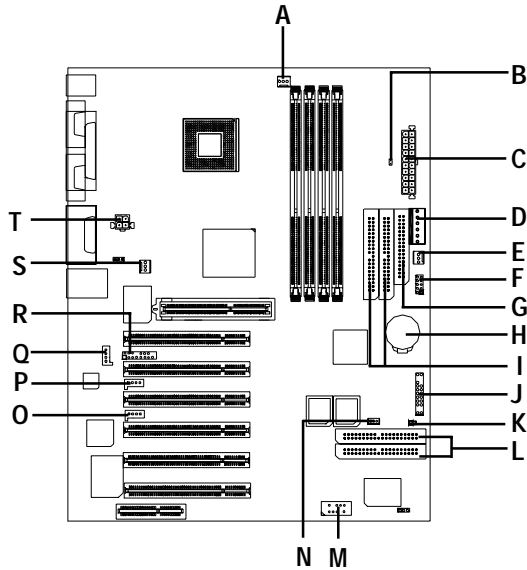

A	PWR_FAN	K	STR LED Connector*
B	RIMM LED	L	IDE3/IDE4*
C	ATX Power	M	Front USB
D	AUX Power	N	Wake On Lan
E	SYS_FAN	O	TEL*
F	IR/CIR	P	AUX IN*
G	FLOPPY	Q	CD IN
H	BATTERY	R	Front Audio
I	IDE1/IDE2	S	CPU FAN
J	Front Panel	T	AUX 12V Power

\*\*\*\* For GA-8ITXR only.

**A / E / S : PWR\_FAN / SYS\_FAN / CPU\_Fan Connector**

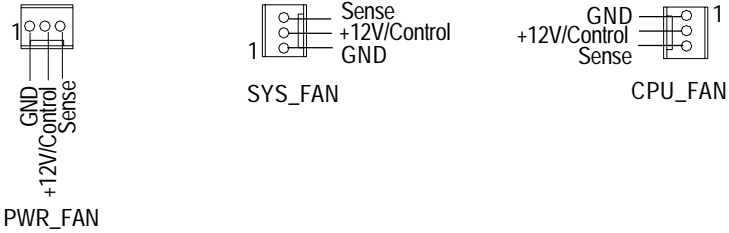

- The CPU fan connector supports Max. current up to 1A and Max. power up to 10W.

**B / K: RIMM LED & STR LED Connector\***



- Do not remove memory modules while RIMM LED is on. It might cause short or other unexpected damages due to the 2.5V stand by voltage. Remove memory modules only when STR function is disabled by jumper and AC Power cord is disconnected.

**C: ATX Power**

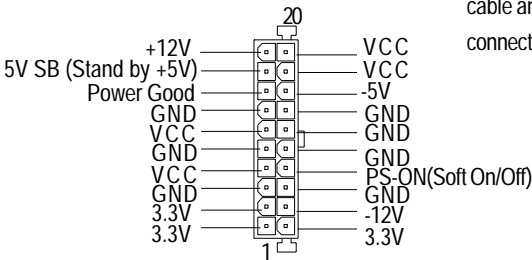

- AC power cord should only be connected to your power supply unit after ATX power cable and other related devices are firmly connected to the mainboard.

\*\*\*\* For GA-8ITXR only.

**D: AUX Power**

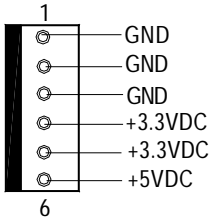

- The 6-pin Aux. Power connector provides additional current to meet the board's +3.3VDC and +5VDC requirements. Please refer to the detail on P.26

**T: AUX +12V Power Connector**

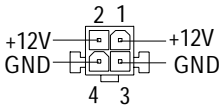

- This connector (ATX +12V) is used only for CPU Core Voltage.

**G / I: Floppy / IDE1 / IDE2 Connector(Primary/Secondary)**

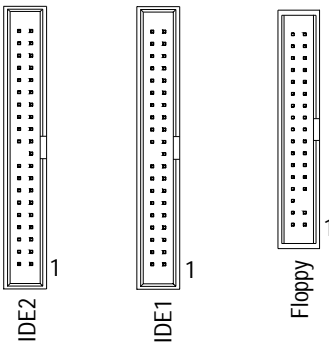

- Important Notice:  
Please connect first harddisk to IDE1 and connect CDROM to IDE2.

**L: IDE3 / IDE4 Connector(RAID/ATA100)\***

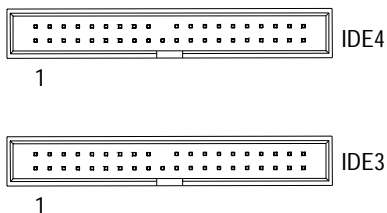

➤ Important Notice:

If you wish to use IDE3 and IDE4, please use it in unity with BIOS(P.47) and JP32(P.25) setting (either RAID or ATA100). Then, install the correct driver to have proper operation. For details, please refer to the manual or the RAID manual inside the CDROM.

**F: IR/CIR**

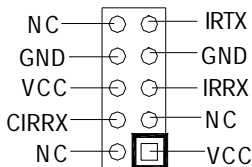

➤ Make sure the pin 1 on the IR device is aligning with pin one the connector. To enable the IR/CIR function on the board, you are required to purchase an option IR/ CIR module. For detail information please contact your authorized Giga-Byte distributor.

To use IR function only, please connect IR module to Pin1 to Pin5.

**N: Wake On Lan**

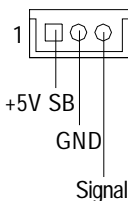

\*\*\* For GA-8ITXR only.

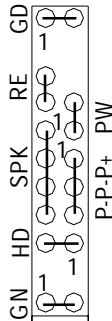

**J: 2x11 pins jumper**

GN (Green Switch)	Open: Normal Operation Close: Entering Green Mode
GD (Green LED)	Pin 1: LED anode(+) Pin 2: LED cathode(-)
HD (IDE Hard Disk Active LED)	Pin 1: LED anode(+) Pin 2: LED cathode(-)
SPK (Speaker Connector)	Pin 1: VCC(+) Pin 2- Pin 3: NC Pin 4: Data(-)
RE (Reset Switch)	Open: Normal Operation Close: Reset Hardware System
P-P-P+(Power LED)	Pin 1: LED anode(+) Pin 2: LED cathode(-) Pin 3: LED cathode(-)
PW (Soft Power Connector)	Open: Normal Operation Close: Power On/Off

- Please connect the power LED, PC speaker, reset switch and power switch etc of your chassis front panel to the front panel jumper according to the pin assignment above.

### M: Front USB Connector

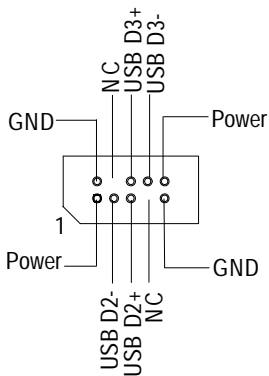

- Be careful with the polarity of the front panel USB connector. Check the pin assignment while you connect the front panel USB cable. Please contact your nearest dealer for optional front panel USB cable.

### O: TEL\*

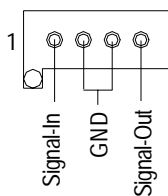

### P: AUX IN\*

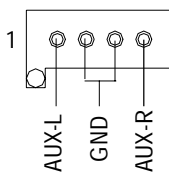

### Q: CD IN

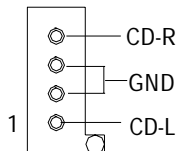

\*\*\* For GA-8ITXR only.

## R: Front Audio

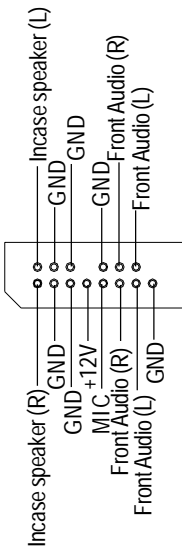

- If you want to use "Front Audio" connector, you must move 11-12,13-14 Jumper.

In order to utilize the front audio header, your chassis must have front audio connector. Also please make sure the pin assignment on the cable is the same as the pin assignment on the MB header. To find out if the chassis you are buying support front audio connector, please contact your dealer.

## H: Battery



### CAUTION

- ❖ Danger of explosion if battery is incorrectly replaced.
- ❖ Replace only with the same or equivalent type recommended by the manufacturer.
- ❖ Dispose of used batteries according to the manufacturer's instructions.

## Jumper Setting

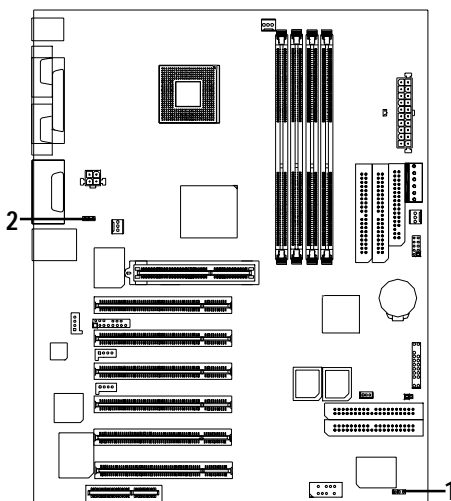

---

1 RAID/ATA100 Selection\*

2 USB\_VS

---

\*\*\* For GA-8ITXR only.

### 1: RAID/ATA100 Selection\*

1  1-2 close: RAID Mode

1  2-3 close: ATA100 Mode(Default)

- If you want to use "RAID Mode", your IDE3 and IDE4 must be connected with Hard device.  
Please set BIOS setting "Onboard Promise Chip" to Enabled before adjusting JP32.

### 2: PS/2 USB Device Wake Up selection

1  1-2 close: Enable

1  2-3 close: Disable(Default)

\*\*\* For GA-8ITXR only.

## ATX 12V Power Supply Introduction

- Additional 4 pin connector for 12V voltage
- Backward compatibility maintained with load sharing capability
- Support 12V or 5V CPU VRs

Check power supply if it is supported by ATX12V Power Supply.

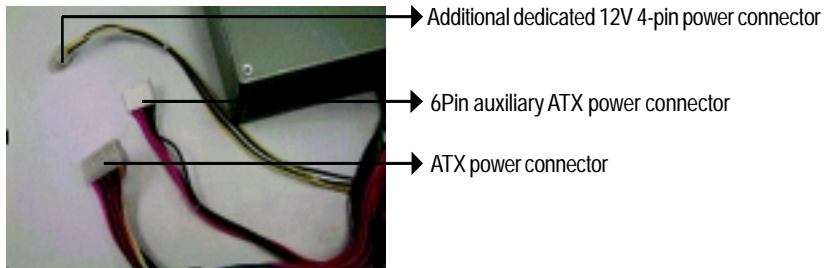

## 6 Pin Aux. Power Connector

Step1: In a 45° angle position, align the tooth of aux. Power cable onto the gird of aux. Power socket.

Step2: Insert the aux. Power cable downward.

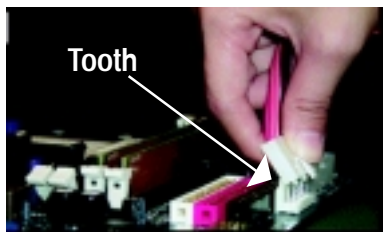

Figure 1



Figure 2

Step3: Properly installed shown below.



Figure 3

## Chapter 3 BIOS Setup

BIOS Setup is an overview of the BIOS Setup Program. The program that allows users to modify the basic system configuration. This type of information is stored in battery-backed CMOS RAM so that it retains the Setup information when the power is turned off.

### ENTERING SETUP

Press <F8> to enter Boot Menu during POST (Power On Self Test); press <F12> to enter Network boot function, press <Del> to enter CMOS Setup.

#### a. Boot Screen



#### b. Press <F8> to enter Boot Menu

Select First Boot Device		
Floppy	:	1.44MB 3 <sup>1/2</sup>
[Up/Dn] Select	[RETURN] Boot	[ESC] Cnancel

Boot order depends on the devices you use, for example: Floppy, HDD, CD-ROM...

c. Press<F12> to boot from Network.

d. After power on the computer, pressing <Del> immediately during POST (Power On Self Test) it will allow you to enter AMI BIOS CMOS SETUP.

## CONTROLKEYS

---

<↑>	Move to previous item
<↓>	Move to next item
<←>	Move to the item in the left hand
<→>	Move to the item in the right hand
<Esc>	Main Menu - Quit and not save changes into CMOS Status Page Setup Menu and Option Page Setup Menu - Exit current page and return to Main Menu
<+/PgUp>	Increase the numeric value or make changes
<-/PgDn>	Decrease the numeric value or make changes
<F1>	General help, only for Status Page Setup Menu and Option Page Setup Menu
<F2>	Reserved
<F3>	Select Language
(Shift)F3	Select Language
<F4>	Reserved
<F5>	Restore the previous CMOS value from CMOS, only for Option Page Setup Menu
<F6>	Load the default CMOS value from BIOS default table, only for Option Page Setup Menu
<F7>	Load the Setup Defaults
<F8>	Flash Utility
<F9>	Reserved
<F10>	Save all the CMOS changes, only for Main Menu

---



## GETTINGHELP

### Main Menu

The on-line description of the highlighted setup function is displayed at the bottom of the screen.

### Status Page Setup Menu / Option Page Setup Menu

Press F1 to pop up a small help window that describes the appropriate keys to use and the possible selections for the highlighted item. To exit the Help Window press <Esc>.

## Select Language

You can press <F3> to select multi language. There are 7 languages available, include English, Japanese, French, Spanish, Germany, Simplified Chinese, Traditional Chinese.

## The Main Menu (For example: BIOS Ver. :F4)

Once you enter AMI BIOS CMOS Setup Utility, the Main Menu (Figure 1) will appear on the screen. The Main Menu allows you to select from eight setup functions and two exit choices. Use arrow keys to select among the items and press <Enter> to accept or enter the sub-menu.

AMIBIOS SIMPLE SETUP UTILITY - VERSION 2.00 (C) 2001 American Megatrends, Inc. All Rights Reserved	
STANDARD CMOS SETUP	INTEGRATED PERIPHERALS
BIOS FEATURES SETUP	HARDWARE MONITOR & MISC SETUP
CHIPSET FEATURES SETUP	SUPERVISOR PASSWORD
POWER MANAGEMENT SETUP	USER PASSWORD
PNP / PCI CONFIGURATIONIDE	HDD AUTO DETECTION
LOAD FAIL-SAFE DEFAULTS	SAVE & EXIT SETUP
LOAD OPTIMIZED DEFAULT	EXIT WITHOUT SAVING
ESC: Quit      ↑↓←→ : Select Item      (Shift)F3 : Select Language      F5: Old Values	
F6: Fail-Safe Values      F7: Optimized Values      F8: Flash Utility      F10: Save & Exit	
Current Language: English	
Time, Date , Hard Disk Type...	

Figure 1: Main Menu

- **Standard CMOS Features**

This setup page includes all the items in standard compatible BIOS.

- **BIOS Features Setup**

This setup page includes all the adjustable items of AMI special enhanced features.

- **Chipset Features Setup**

This setup page includes all the adjustable items of chipset special features.

- **Power Management Setup**

This setup page includes all the adjustable items of Green function features.

- **PNP/PCI Configurations**

This setup page includes all the adjustable configurations of PCI & PnP ISA resources.

- **Load Fail-Safe Defaults**

Load Fail-Safe Defaults option loads preset system parameter values to set the system in its most stable configurations.

- **Load Optimized Defaults**

Load Optimized Defaults option loads preset system parameter values to set the system in its highest performance configurations.

- **Integrated Peripherals**

This setup page includes all onboard peripherals.

- **Hardware Monitor & MISC Setup**

This setup page is auto detect fan and temperature status.

- **Set Supervisor password**

Set Change or disable password. It allows you to limit access to the system and/or BIOS setup.

- **Set User password**

Set Change or disable password. It allows you to limit access to the system.

- **IDE HDD Auto Detection**

Automatically configure hard disk parameters.

- **Save & Exit Setup**

Save CMOS value settings to CMOS and exit setup.

- **Exit Without Saving**

Abandon all CMOS value changes and exit setup.

## Standard CMOS Features

AMIBIOS SETUP - STANDARD CMOS SETUP																																									
( C ) 2001 American Megatrends, Inc. All Rights Reserved																																									
System Date : Aug 01 2001 Wed																																									
System Time : 14:44:35																																									
<table border="1"> <thead> <tr> <th>TYPE</th> <th>SIZE</th> <th>CYLS</th> <th>HEAD</th> <th>PRECOMP</th> <th>LANDZ</th> <th>SECTOR</th> <th>MODE</th> </tr> </thead> <tbody> <tr> <td>Pri Master</td> <td>: Auto</td> <td></td> <td></td> <td></td> <td></td> <td></td> <td></td> </tr> <tr> <td>Pri Slave</td> <td>: Auto</td> <td></td> <td></td> <td></td> <td></td> <td></td> <td></td> </tr> <tr> <td>Sec Master</td> <td>: Auto</td> <td></td> <td></td> <td></td> <td></td> <td></td> <td></td> </tr> <tr> <td>Sec Slave</td> <td>: Auto</td> <td></td> <td></td> <td></td> <td></td> <td></td> <td></td> </tr> </tbody> </table>		TYPE	SIZE	CYLS	HEAD	PRECOMP	LANDZ	SECTOR	MODE	Pri Master	: Auto							Pri Slave	: Auto							Sec Master	: Auto							Sec Slave	: Auto						
TYPE	SIZE	CYLS	HEAD	PRECOMP	LANDZ	SECTOR	MODE																																		
Pri Master	: Auto																																								
Pri Slave	: Auto																																								
Sec Master	: Auto																																								
Sec Slave	: Auto																																								
Floppy Drive A : 1.44 MB 3 <sup>1/2</sup>	Base Memory : 640 Kb																																								
Floppy Drive B : Not Installed	Other Memory : 384 Kb																																								
	Extended Memory : 255 Mb																																								
Virus Protection : Disabled	Total Memory : 256 Mb																																								
Date is standard format	ESC : Exit																																								
Month : Jan - Dec	↑↓ : Select Item																																								
Day : 01- 31	PU / PD / + / - :Modify																																								
Year : 1990 - 2099	(Shift) F3 : Select Language																																								

Figure 2: Standard CMOS Setup

### System Date

The date format is <month>, <day>, <year>, <week>.

- ▶▶ Month      The month, Jan. Through Dec.
- ▶▶ Day        The day, from 1 to 31 (or the maximum allowed in the month)
- ▶▶ Year        The year, from 1990 through 2099
- ▶▶ Week        The week, from Sun to Sat, determined by the BIOS and is display only

### **SystemTime**

The times format in <hour> <minute> <second>. The time is calculated base on the 24-hour military-time clock. For example, 1 p.m. is 13:00:00.

### **Primary Master, Slave / Secondary Master, Slave**

The category identifies the types of hard disk from drive C to F that has been installed in the computer. There are two types: auto type, and manual type. Manual type is user-definable; Auto type which will automatically detect HDD type.

Note that the specifications of your drive must match with the drive table. The hard disk will not work properly if you enter improper information for this category.

If you select User Type, related information will be asked to enter to the following items. Enter the information directly from the keyboard and press <Enter>. Such information should be provided in the documentation form your hard disk vendor or the system manufacturer.

- ▶▶ CYLS.                    Number of cylinders
- ▶▶ HEADS                 number of heads
- ▶▶ PRECOMP             write precomp
- ▶▶ LANDZONE            Landing zone
- ▶▶ SECTORS             number of sectors

If a hard disk has not been installed select NONE and press <Enter>.

### **Floppy Drive A / Drive B**

The category identifies the types of floppy disk drive A or drive B that has been installed in the computer.

- ▶▶ None                    No floppy drive installed
- ▶▶ 360K, 5.25 in.        5.25 inch PC-type standard drive; 360K byte capacity.
- ▶▶ 1.2M, 5.25 in.        5.25 inch AT-type high-density drive; 1.2M byte capacity  
(3.5 inch when 3 Mode is Enabled).
- ▶▶ 720K, 3.5 in.         3.5 inch double-sided drive; 720K byte capacity
- ▶▶ 1.44M, 3.5 in.        3.5 inch double-sided drive; 1.44M byte capacity.
- ▶▶ 2.88M, 3.5 in.        3.5 inch double-sided drive; 2.88M byte capacity.

---

## 🔑 Virus Protection

If it is set to enable, the category will flash on the screen when there is any attempt to write to the boot sector or partition table of the hard disk drive. The system will halt and the following error message will appear in the mean time. You can run anti-virus program to locate the problem.

- ▶▶ Enabled     Activate automatically when the system boots up causing a warning message to appear when anything attempts to access the boot sector or hard disk partition table
  
- ▶▶ Disabled     No warning message to appear when anything attempts to access the boot sector or hard disk partition table (Default Value)

## 🔑 Memory

The category is display-only which is determined by POST (Power On Self Test) of the BIOS.

### **Base Memory**

The POST of the BIOS will determine the amount of base (or conventional) memory installed in the system.

The value of the base memory is typically 512 K for systems with 512 K memory installed on the motherboard, or 640 K for systems with 640 K or more memory installed on the motherboard.

### **Other Memory**

This refers to the memory located in the 640 K to 1024 K address space. This is memory that can be used for different applications.

DOS uses this area to load device drivers to keep as much base memory free for application programs. Most use for this area is Shadow RAM.

### **ExtendedMemory**

The BIOS determines how much extended memory is present during the POST.

This is the amount of memory located above 1 MB in the CPU's memory address map.

## BIOS Features Setup

AMIBIOS SETUP - BIOS FEATURES SETUP	
( C ) 2001 American Megatrends, Inc. All Rights Reserved	
BIOS Flash Protection	: Auto
1st Boot Device	: Floppy
2nd Boot Device	: IDE-0
3rd Boot Device	: CDROM
Floppy Drive Seek	: Disabled
BootUp Num-Lock	: On
Password Check	: Setup
S.M.A.R.T. for Hard Disks	: Disabled
ESC: Quit                    ↑↓←→: Select Item F1 : Help                    PU/PD+/-/ : Modify F5 : Old Values (Shift)F3: Select Language F6 : Fail-Safe              F8: Flash Utility F7 : Optimized	

Figure 3: BIOS Features Setup

### ☞ BIOS Flash Protection

- ▶▶ Auto                    Will be automatically detected by BIOS. (Default value)
- ▶▶ Enabled                Enable BIOS Flash Protection. This will prevent BIOS Flash write after POST.

### ☞ 1st / 2nd / 3rd Boot device

- ▶▶ Floppy                    Select your boot device priority by Floppy.
- ▶▶ ARMD-FDD                Select your boot device priority by ARMD-FDD.
- ▶▶ ARMD-HDD                Select your boot device priority by ARMD-HDD.
- ▶▶ CDROM                    Select your boot device priority by CDROM.
- ▶▶ SCSI                      Select your boot device priority by SCSI.
- ▶▶ NETWORK                 Select your boot device priority by NETWORK.
- ▶▶ BBS-0                    Select your boot device priority by BIOS Boot Specification-0.\*\*
- ▶▶ BBS-1                    Select your boot device priority by BIOS Boot Specification-1.
- ▶▶ BBS-2                    Select your boot device priority by BIOS Boot Specification-2.
- ▶▶ BBS-3                    Select your boot device priority by BIOS Boot Specification-3.

\*\*\*\* For GA-8ITX Only.

- ▶▶ USB FDD      Select your boot device priority by USB FDD.
- ▶▶ USB CDROM    Select your boot device priority by USB CDROM.
- ▶▶ USB HDD      Select your boot device priority by USB HDD.
- ▶▶ USB LS120    Select your boot device priority by USB LS120.
- ▶▶ USB ZIP/MO    Select your boot device priority by USB ZIP/MO.
- ▶▶ Disabled      Disable this function.
- ▶▶ IDE-0-3      Select your boot device priority by IDE-0-3.
- ▶▶ RAID/ATA100   Select your boot device priority by RAID/ATA100. \*

### ☞ Floppy Drive Seek

During POST, BIOS will determine the floppy disk drive installed is 40 or 80 tracks. 360 K type is 40 tracks 720 K, 1.2 M and 1.44 M are all 80 tracks.

- ▶▶ Enabled      BIOS searches for floppy disk drive to determine it is 40 or 80 tracks. Note that BIOS can not tell from 720 K, 1.2 M or 1.44 M drive type as they are all 80tracks.
- ▶▶ Disabled      BIOS will not search for the type of floppy disk drive by track number. Note that there will not be any warning message if the drive installed is 360 K. (Default value)

### ☞ Boot Up NumLock

- ▶▶ On            Keypad is number keys. (Default value)
- ▶▶ Off          Keypad is arrow keys.

### ☞ Password Check

Please refer to the detail on P.55

- ▶▶ Always      The user must enter correct password in order to access the system and/or BIOS Setup.
- ▶▶ Setup      The user must enter correct password in order to access BIOS setup utility. (Default Value)

### ☞ HDDS.M.A.R.T Capability

- ▶▶ Enabled      Enable HDD S.M.A.R.T. Capability.
- ▶▶ Disabled      Disable HDD S.M.A.R.T. Capability. (Default value)

\*\*\* For GA-8ITXR Only.

## Chipset Features Setup

AMIBIOS SETUP - CHIPSET FEATURES SETUP	
( C ) 2001 American Megatrends, Inc. All Rights Reserved	
Front Side Bus Clock (MHz) : By Hardware	
CPU Frequency Ratio : 8.0x(Safe)	
RDRAM Bus Frequency : Auto	
Vcore Voltage : Original*	
Over RIMM Voltage : Disabled*	
Over AGP Voltage : 1.5V*	
Memory ECC Mode : Disabled	
Graphics Aperture Size : 64MB	ESC: Quit      ↑↓←→: Select Item
ICH Delayed Transaction : Disabled	F1 : Help      PU/PD+/-/: Modify
DMA Collection Buffer : Enabled	F5 : Old Values (Shift)F3: Select Language
	F6 : Fail-Safe      F8: Flash Utility
	F7 : Optimized

Figure 4: Chipset Features Setup

### ☞ Front Side Bus Clock (MHz)

When set to "By Hardware", the FSB clock frequency will be set to 100MHz. You may also set FSB clock by BIOS. For power End-User use only.

- ▶▶ By Hardware      Set Front Side Bus Clock (MHz) to By Hardware. (Default Value)
- ▶▶ 100.00            Set Front Side Bus Clock (MHz) to 100.00.
- ▶▶ 103.00            Set Front Side Bus Clock (MHz) to 103.00.
- ▶▶ 105.00            Set Front Side Bus Clock (MHz) to 105.00.
- ▶▶ 108.00            Set Front Side Bus Clock (MHz) to 108.00.
- ▶▶ 110.00            Set Front Side Bus Clock (MHz) to 110.00.
- ▶▶ 112.00            Set Front Side Bus Clock (MHz) to 112.00.
- ▶▶ 115.00            Set Front Side Bus Clock (MHz) to 115.00.
- ▶▶ 118.00            Set Front Side Bus Clock (MHz) to 118.00.
- ▶▶ 120.00            Set Front Side Bus Clock (MHz) to 120.00.
- ▶▶ 133.33            Set Front Side Bus Clock (MHz) to 133.33.

\*\*\* For GA-8ITXR Only.



---

### CPU Frequency Ratio

- ▶▶ 8.0x, 10.0x~24.0x (Default Value: 8.0x)

### RDRAM Bus Frequency

- ▶▶ Auto Set RDRAM Bus Frequency automatically. (Default Value)
- ▶▶ 400MHz Set RDRAM Bus Frequency to 400MHz. (If the current RDRAM is supported)
- ▶▶ 300MHz Set RDRAM Bus Frequency to 300MHz. (If the current RDRAM is supported)

### Vcore Voltage\*

- ▶▶ Original Original Vcore Voltage. (Default Value)
- ▶▶ +0.025V Original Vcore Voltage +0.025V.
- ▶▶ +0.050V Original Vcore Voltage +0.050V.
- ▶▶ +0.075V Original Vcore Voltage +0.075V.
- ▶▶ +0.100V Original Vcore Voltage +0.100V.

### Over RIMM Voltage\*

- ▶▶ Disabled Disable this function. (Default Value)
- ▶▶ Enabled Enable Over RIMM Voltage function.

### Over AGP Voltage\*

- ▶▶ 1.5V Set Over AGP Voltage to 1.5V.(Default Value)
- ▶▶ 1.6V Set Over AGP Voltage to 1.6V.
- ▶▶ 1.7V Set Over AGP Voltage to 1.7V.
- ▶▶ 1.8V Set Over AGP Voltage to 1.8V.

### Memory ECC Mode

- ▶▶ Enabled Enable Memory Data Check ECC Mode.
- ▶▶ Disabled Disable this function. (Default Value)

\*\*\* For GA-8ITXR Only.

### **Graphics Aperture**

- ▶▶ 4 MB      Display Graphics Aperture Size is 4MB.
- ▶▶ 8 MB      Display Graphics Aperture Size is 8MB.
- ▶▶ 16 MB     Display Graphics Aperture Size is 16MB.
- ▶▶ 32 MB     Display Graphics Aperture Size is 32MB.
- ▶▶ 64 MB     Display Graphics Aperture Size is 64MB. (Default Value)
- ▶▶ 128 MB    Display Graphics Aperture Size is 128MB.
- ▶▶ 256 MB    Display Graphics Aperture Size is 256MB.

### **ICH Delayed Transaction**

- ▶▶ Enabled    Enable PCI 2.1 features including release and delayed transaction for the chipset.
- ▶▶ Disabled   Disable this function. (Default Value)

### **DMA Collection Buffer**

- ▶▶ Enabled    Enable DMA collection buffer for LPC I/F and PC/PCI DMA.(Default Value)
- ▶▶ Disabled   Disable this function.

## Power Management Setup

AMIBIOS SETUP - POWER MANAGEMENT SETUP		
( C ) 2001 American Megatrends, Inc. All Rights Reserved		
ACPI Sleep Type	: S1/POS	PIRQ[B] IRQ Active : Ignore
USB Dev Wakeup From S3	: Disabled	PIRQ[C] IRQ Active : Ignore
Suspend Time Out (Minute)	: Disabled	PIRQ[D] IRQ Active : Ignore
Throttle Slow Clock Ratio	: 50.0%	
Soft-Off by Power Button	: Instant Off	
System After AC Back	: Off	
ModemRingOn/WakeOnLan	: Enabled	
PME Event Wake Up	: Enabled	
Resume by RTC Alarm	: Disabled	
RTC Alarm Date	: Event Day	
RTC Alarm Hour	: 00	
RTC Alarm Minute	: 00	
RTC Alarm Second	: 00	
KB & PS/2 Mouse Access	: Monitor	
FDC/LPT/COM Ports Access	: Monitor	
Pri. Master IDE Access	: Monitor	ESC: Quit            ↑ ↓ ← → : Select Item
Pri. Slave IDE Access	: Ignore	F1 : Help            PU/PD+/-/ : Modify
Sec. Master IDE Access	: Monitor	F5 : Old Values (Shift)F3: Select Language
Sec. Slave IDE Access	: Ignore	F6 : Fail-Safe      F8: Flash Utility
PIRQ[A] IRQ Active	: Ignore	F7 : Optimized

Figure 5: Power Management Setup

### ☞ **ACPI Sleep Type**

- ▶▶ S1/POS Set ACPI Sleep Type to S1/POS (Power On Suspend). (Default value)
- ▶▶ S3/STR Set ACPI Sleep Type to S3/STR (Suspend To RAM).

### ☞ **USB Dev Wakeup From S3**

- ▶▶ Enabled Enable USB Device Wakeup From S3.
- ▶▶ Disabled Disable USB Device Wakeup From S3. (Default value)

### ☞ **Suspend Time Out**

- ▶▶ Disabled Disable the timer to enter suspend mode. (Default Value)
- ▶▶ 1Minute ~ 60 Minute Set the timer to enter suspend mode.

### ☞ **Throttle Slow Clock Ratio**

- ▶▶ 12.5%/25.0%/37.5%/50.0% (Default Value)/62.5%/75.0%/87.5%

### ☞ **Soft-off by Power Button**

- ▶▶ Instant off The user press the power button once, he can turn off the system. (Default Value)
- ▶▶ Suspend The user press the power button once, then he can enter suspend mode.

### ☞ **System after AC Back**

- ▶▶ Off When AC-power back to the system, the system will be in "Off" state. (Default Value)
- ▶▶ On When AC-power back to the system, the system will be in "On" state.
- ▶▶ Last State When AC-power back to the system, the system will return to the Last state before AC-power off.

### ☞ **ModemRingOn/WakeOnLan**

- ▶▶ Disabled Disable Modem Ring On / Wake On LAN function.
- ▶▶ Enabled The modem ring / LAN wake up will bring the system out of soft-off or suspend state if this option is set "Enabled". (Default Value)

---

### ☞ **PME Event Wake up**

- ▶▶ Disabled     Disable PME event wake up function.
- ▶▶ Enabled     The PME event wake up will bring the system out of soft-off or suspend state if this option is set "Enabled". (Default Value)

### ☞ **Resume by RTC Alarm**

You can set "Resume by RTC Alarm " item to enabled and key in Data/time to power on system.

- ▶▶ Disabled     Disable this function. (Default Value)
- ▶▶ Enabled     Enable alarm function to POWER ON system.

If Resume by RTC Alarm is Enabled.

- ▶▶ RTC Alarm Date:            Every Day, 1~31
- ▶▶ RTC Alarm Hour:           0~23
- ▶▶ RTC Alarm Minute:        0~59
- ▶▶ RTC Alarm Second:        0~59

### ☞ **KB & PS/2 Mouse Access**

- ▶▶ Monitor        Monitor Keyboard & PS/2 Mouse Access. (Default Value)
- ▶▶ Ignore         Ignore Keyboard & PS/2 Mouse Access.

### ☞ **FDC/LPT/COM Ports Access**

- ▶▶ Monitor        Monitor FDC/LPT/COM Ports Access. (Default Value)
- ▶▶ Ignore         Ignore FDC/LPT/COM Ports Access.

### ☞ **Pri. Master IDE Access**

- ▶▶ Monitor        Monitor Primary Master IDE Access. (Default Value)
- ▶▶ Ignore         Ignore Primary Master IDE Access.

### ☞ **Pri. slave IDE Access**

- ▶▶ Monitor        Monitor Primary slave IDE Access.
- ▶▶ Ignore         Ignore Primary slave IDE Access. (Default Value)

☞ **Sec. Master IDE Access**

- ▶▶ Monitor      Monitor Secondary Master IDE Access. (Default Value)
- ▶▶ Ignore      Ignore Secondary Master IDE Access.

☞ **Sec. slave IDE Access**

- ▶▶ Monitor      Monitor Secondary slave IDE Access.
- ▶▶ Ignore      Ignore Secondary slave IDE Access.(Default Value)

☞ **PIRQ[A] IRQ Active**

- ▶▶ Monitor      Monitor PIRQ[A] IRQ Active.
- ▶▶ Ignore      Ignore PIRQ[A] IRQ Active. (Default Value)

☞ **PIRQ[B] IRQ Active**

- ▶▶ Monitor      Monitor PIRQ[B] IRQ Active.
- ▶▶ Ignore      Ignore PIRQ[B] IRQ Active. (Default Value)

☞ **PIRQ[C] IRQ Active**

- ▶▶ Monitor      Monitor PIRQ[C] IRQ Active.
- ▶▶ Ignore      Ignore PIRQ[C] IRQ Active. (Default Value)

☞ **PIRQ[D] IRQ Active**

- ▶▶ Monitor      Monitor PIRQ[D] IRQ Active.
- ▶▶ Ignore      Ignore PIRQ[D] IRQ Active. (Default Value)

## PNP/PCI Configuration

AMIBIOS SETUP - PNP/PCI CONFIGURATION	
( C ) 2001 American Megatrends, Inc. All Rights Reserved	
Reset Configuration Data	: Disabled
VGA Boot From	: AGP
PCI Slot 1/5 IRQ Priority	: Auto
PCI Slot 2/6 IRQ Priority	: Auto
PCI Slot 3 IRQ Priority	: Auto
PCI Slot 4 IRQ Priority	: Auto
IRQ3	: PCI/PnP
IRQ4	: PCI/PnP
IRQ5	: PCI/PnP
IRQ7	: PCI/PnP
IRQ9	: PCI/PnP
IRQ10	: PCI/PnP
IRQ11	: PCI/PnP
IRQ14	: PCI/PnP
IRQ15	: PCI/PnP
ESC: Quit                    ↑↓←→: Select Item F1 : Help                    PU/PD+/-/: Modify F5 : Old Values (Shift)F3: Select Language F6 : Fail-Safe              F8: Flash Utility F7 : Optimized	

Figure 6: PNP/PCI Configuration

### ☞ Reset Configuration Data

Advising BIOS clear PnP configuration data for usable value.

- ▶▶ Disabled      Disable this function. (Default Value)
- ▶▶ Enabled      Reset PnP configuration data in order to re-initialize ESCD for PnP device.

### ☞ VGA Boot From

- ▶▶ AGP              Set VGA Boot from AGP VGA Card. (Default Value)
- ▶▶ PCI              Set VGA Boot from PCI VGA Card.

### ☞ **PCI Slot1/5, 2/6, 3, 4 IRQ Priority**

- ▶▶ Auto      The system will reserved a free IRQ for PCI slot 1/5, 2/6, 3, 4 device.  
(Default Value)
- ▶▶ 3          The system will reserved IRQ3 for PCI slot 1/5, 2/6, 3, 4 device if no legacy ISA device using IRQ3.
- ▶▶ 4          The system will reserved IRQ for PCI slot 1/5, 2/6, 3, 4 device if no legacy ISA device using IRQ4.
- ▶▶ 5          The system will reserved IRQ5 for PCI slot 1/5, 2/6, 3, 4 device if no legacy ISA device using IRQ5.
- ▶▶ 7          The system will reserved IRQ7 for PCI slot 1/5, 2/6, 3, 4 device if no legacy ISA device using IRQ7.
- ▶▶ 9          The system will reserved IRQ9 for PCI slot 1/5, 2/6, 3, 4 device if no legacy ISA device using IRQ9.
- ▶▶ 10         The system will reserved IRQ10 for PCI slot 1/5, 2/6, 3, 4 device if no legacy ISA device using IRQ10.
- ▶▶ 11         The system will reserved IRQ11 for PCI slot 1/5, 2/6, 3, 4 device if no legacy ISA device using IRQ11.

### ☞ **IRQ (3,4,5,7,9,10,11,14,15)**

- ▶▶ ISA          The resource reserved for Legacy ISA device.
- ▶▶ PCI / PnP     The resource can be assigned to PCI/ PnP device.



## Load Fail-Safe Defaults

AMIBIOS SIMPLE SETUP UTILITY - VERSION 2.00 (C) 2001 American Megatrends, Inc. All Rights Reserved	
STANDARD CMOS SETUP	INTEGRATED PERIPHERALS
BIOS FEATURES SETUP	HARDWARE MONITOR & MISC SETUP
CHIPSET FEATURES SETUP	SUPERVISOR PASSWORD
POWER MANAGEMENT SETUP	LOAD FAIL-SAFE DEFAULTS
PNP / PCI CONFIGURATION	LOAD OPTIMIZED DEFAULTS
LOAD FAIL-SAFE DEFAULTS	SAVE & EXIT SETUP
LOAD OPTIMIZED DEFAULTS	EXIT WITHOUT SAVING
ESC: Quit      ↑↓←→ : Select Item      (Shift)F3 : Select Language      F5: Old Values F6: Fail-Safe Values      F7: Optimized Values      F8: Flash Utility      F10: Save & Exit	
Current Language: English	
Load Fail-Safe Defaults	

Figure 7: Load Fail-Safe Defaults

### Load Fail-Safe Defaults

Fail-Safe defaults contain the most appropriate system parameter values of to configure the system to achieve maximum stability.

## Load Optimized Defaults

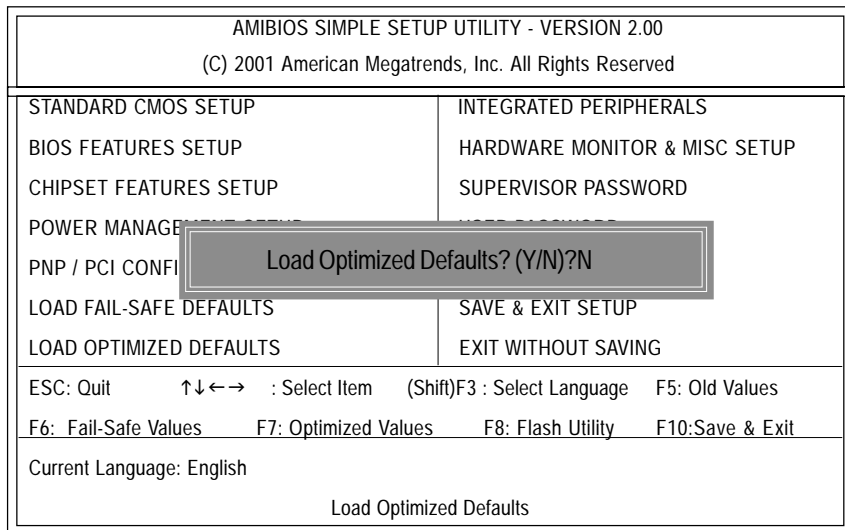

Figure 8: Load Optimized Defaults

### Load Optimized Defaults

Optimized defaults contain the most appropriate system parameter values to configure the system to achieve maximum performance.

## Integrated Peripherals

AMIBIOS SETUP - INTEGRATED PERIPHERALS			
( C ) 2001 American Megatrends, Inc. All Rights Reserved			
OnBoard IDE	: Both	Specific Key for PowerOn	: N/A
IDE1 Conductor Cable	: Auto	USB Function	: Enabled
IDE2 Conductor Cable	: Auto	USB Legacy Support	: Disabled
OnBoard FDC	: Auto	AC97 Audio	: Auto
OnBoard Serial Port A	: Auto	AC97 Modem	: Auto
OnBoard Serial Port B	: Auto	Onboard Lan Chip	: Enabled*
Serial Port B Mode	: Normal	Onboard Sound Chip	: Enabled*
IR Duplex Mode	: Half Duplex	Onboard Promise Chip	: Enabled*
OnBoard CIR Port	: Disabled		
CIR IRQ Select	: 10		
OnBoard Parallel Port	: Auto		
Parallel Port Mode	: ECP		
EPP Version	: N/A		
Parallel Port IRQ	: Auto		
Parallel Port DMA	: Auto		
OnBoard Midi Port	: Disabled**	ESC: Quit	↑↓←→: Select Item
Midi IRQ Select	: 10**	F1 : Help	PU/PD+/-/ : Modify
OnBoard Game Port	: 200**	F5 : Old Values	(Shift)F3: Select Language
Mouse PowerOn Function	: Disabled	F6 : Fail-Safe	F8: Flash Utility
Keyboard PowerOn Function	: Disabled	F7 : Optimized	

Figure 9: Integrated Peripherals

\*\*\* For GA-8ITXR Only.

\*\*\*\* For GA-8ITX Only.

### ☞ **OnBoard IDE**

- ▶▶ Disabled      Disable OnBoard IDE.
- ▶▶ Both          Both Primary & Secondary IDE channel will be enabled. (Default Value)
- ▶▶ Primary      Only Primary IDE channel is enabled.
- ▶▶ Secondary    Only Secondary IDE channel is enabled.

### ☞ **IDE1 Conductor Cable**

- ▶▶ Auto          Will be automatically detected by BIOS. (Default Value)
- ▶▶ ATA66/100    Set IDE1 Conductor Cable to ATA66/100 (Please make sure your IDE device and cable is compatible with ATA66/100).
- ▶▶ ATA33        Set IDE1 Conductor Cable to ATA33 (Please make sure your IDE device and cable is compatible with ATA33).

### ☞ **IDE2 Conductor Cable**

- ▶▶ Auto          Will be automatically detected by BIOS. (Default Value)
- ▶▶ ATA66/100    Set IDE2 Conductor Cable to ATA66/100 (Please make sure your IDE device and cable is compatible with ATA66/100).
- ▶▶ ATA33        Set IDE2 Conductor Cable to ATA33 (Please make sure your IDE device and cable is compatible with ATA33).

### ☞ **OnBoard FDC**

- ▶▶ Disabled      Disable this function.
- ▶▶ Enabled      Enable on board floppy disk controller.
- ▶▶ Auto          Set the floppy disk controller automatically. (Default Value)

### ☞ **Onboard Serial Port A**

- ▶▶ Auto          BIOS will automatically setup the port A address. (Default Value)
- ▶▶ 3F8/COM1     Enable onboard Serial port A and address is 3F8.
- ▶▶ 2F8/COM2     Enable onboard Serial port A and address is 2F8.
- ▶▶ 3E8/COM3     Enable onboard Serial port A and address is 3E8.
- ▶▶ 2E8/COM4     Enable onboard Serial port A and address is 2E8.
- ▶▶ Disabled      Disable onboard Serial port A.

---

### ☞ Onboard Serial Port B

- ▶▶ Auto BIOS will automatically setup the port B address. (Default Value)
- ▶▶ 3F8/COM1 Enable onboard Serial port B and address is 3F8.
- ▶▶ 2F8/COM2 Enable onboard Serial port B and address is 2F8.
- ▶▶ 3E8/COM3 Enable onboard Serial port B and address is 3E8.
- ▶▶ 2E8/COM4 Enable onboard Serial port B and address is 2E8.
- ▶▶ Disabled Disable onboard Serial port B.

### ☞ Serial Port B Mode

(This item allows you to determine which Infra Red(IR) function of Onboard I/O chip)

- ▶▶ ASKIR Set onboard I/O chip UART to ASKIR Mode.
- ▶▶ IrDa Set onboard I/O chip UART to IrDa Mode.
- ▶▶ Normal Set onboard I/O chip UART to Normal Mode. (Default Value)

### ☞ IR Duplex Mode

- ▶▶ Half Duplex IR Function Duplex Half. (Default Value)
- ▶▶ Full Duplex IR Function Duplex Full.

### ☞ OnBoard CIR Port

- ▶▶ Disabled Disable this function. (Default Value)
- ▶▶ Enabled Enable Onboard CIR port.

### ☞ CIR IRQ Select

- ▶▶ IRQ 3 / 4 / 9 / 10 (Default Value) / 11

### ☞ Onboard Parallel Port

- ▶▶ 378 Set On Board LPT port and address to 378.
- ▶▶ 278 Set On Board LPT port and address to 278.
- ▶▶ 3BC Set On Board LPT port and address to 3BC.
- ▶▶ Auto Set On Board LPT port Automatically. (Default Value)
- ▶▶ Disabled Disable onboard Serial port A.

### ☞ **Parallel Port Mode**

- ▶▶ EPP Using Parallel port as Enhanced Parallel Port.
- ▶▶ ECP Using Parallel port as Extended Capabilities Port. (Default Value)
- ▶▶ Normal Normal Operation.

### ☞ **EPP Version**

- ▶▶ N/A Disable this function. (Default Value)
- ▶▶ 1.9 Compliant with EPP 1.9 version.
- ▶▶ 1.7 Compliant with EPP 1.7 version.

### ☞ **Parallel Port IRQ**

- ▶▶ 7 Set Parallel Port IRQ to 7.
- ▶▶ 5 Set Parallel Port IRQ to 5.
- ▶▶ Auto Set Parallel Port IRQ automatically. (Default Value)

### ☞ **Parallel Port DMA**

- ▶▶ 3 Set Parallel Port DMA to 3.
- ▶▶ 1 Set Parallel Port DMA to 1.
- ▶▶ 0 Set Parallel Port DMA to 0.
- ▶▶ Auto Set Parallel Port DMA automatically. (Default Value)

### ☞ **OnBoard Midi Port\*\***

- ▶▶ Disabled Disable onboard Midi Port. (Default Value)
- ▶▶ 300 Set onboard Midi Port to 300.
- ▶▶ 330 Set onboard Midi Port to 330.
- ▶▶ 292 Set onboard Midi Port to 292.
- ▶▶ 290 Set onboard Midi Port to 290.

### ☞ **Midi IRQ Select\*\***

- ▶▶ IRQ 5 / 7 / 9 / 10 (Default Value)

\*\*\*\* For GA-8ITX Only.

---

### ☞ OnBoard Game Port\*\*

- ▶▶ Disabled    Disable OnBoard Game Port.
- ▶▶ 200         Set OnBoard Game Port to 200. (Default Value)
- ▶▶ 208         Set OnBoard Game Port to 208.

### ☞ Mouse PowerOn Function

- ▶▶ Disabled    Disable this function. (Default Value)
- ▶▶ Right -button    Click right-button to power on the system.
- ▶▶ Left-button     Click Left-button to power on the system.

### ☞ Keyboard PowerOn Function

- ▶▶ Disabled    Disable this function. (Default Value)
- ▶▶ Specific key    Set password key to power on by keyboard.
- ▶▶ Power Key     Set "Power key" to power on the system.

### ☞ Specific Key for PowerOn

- ▶▶ N/A            Disable this function. (Default Value)
- ▶▶ Password ↵    Input password (from 1 to 5 characters) and press Enter to set the Key board Power On Password.

### ☞ USB Function

- ▶▶ Enabled       Enable USB Function. (Default Value)
- ▶▶ Disabled      Disable this function.

### ☞ USB Legacy Support

- ▶▶ Enabled       Enable USB Legacy Support.
- ▶▶ Disabled      Disable this function.(Default Value)

\*\*\*\* For GA-8ITX Only.

### ☞ **AC97 Audio**

- ▶▶ Auto      Enable onboard AC'97 audio function. (Default Value)
- ▶▶ Disabled      Disable this function.

### ☞ **AC97 Modem**

- ▶▶ Auto      BIOS will search MC97 Codec (AMR Modem Card). If found, MC97 function will be enabled. If no MC97 Codec found, MC97 function will be disabled. (Default Value)
- ▶▶ Disabled      Disable this function.

### ☞ **Onboard Lan Chip\***

- ▶▶ Disabled      Disable this function.
- ▶▶ Enabled      Enable Onboard Lan Chip function. (Default Value)

### ☞ **Onboard Sound Chip\***

- ▶▶ Disabled      Disable this function.
- ▶▶ Enabled      Enable Onboard Sound Chip function. (Default Value)

### ☞ **Onboard Promise Chip\***

- ▶▶ Disabled      Disable this function.
- ▶▶ Enabled      Enable Onboard Promise Chip function. (Default Value)

\*\*\* For GA-8ITXR Only.



## Hardware Monitor & MISC Setup

AMIBIOS SETUP - HARDWARE MONITOR & MISC SETUP	
( C ) 2001 American Megatrends, Inc. All Rights Reserved	
CPU Temp. Alarm	:Disabled
CPU Fan Fail Alarm	:No
Power Fan Fail Alarm	:No
System Fan Fail Alarm	:No
Current CPU Temp.	: 35°C/ 95°F
Current System Temp.	: 33°C/ 91°F
Current CPU Fan Speed	: 5273 RPM
Current System Fan Speed	: 0 RPM
Current Power Fan Speed	: 0 RPM
CPU VID	: 1.700 V
Vcore	: +1.632V
Vcc18	: +1.840V
Vio	: +3.344V
+5.000V	: +5.080V
+12.000V	: +11.840V
Battery	: +3.020V
+5V SB	: +4.972V
ESC: Quit            ↑↓←→ : Select Item F1 : Help            PU/PD+/- : Modify F5 : Old Values    (Shift)F3: Select Language F6 : Fail-Safe      F8: Flash Utility F7 : Optimized	

Figure 10: Hardware Monitor &amp; MISC Setup

### CPU Temp. Alarm

- ▶▶ 60°C / 140°F    Monitor CPU Temp. at 60°C / 140°F.
- ▶▶ 70°C / 158°F    Monitor CPU Temp. at 70°C / 158°F.
- ▶▶ 80°C / 176°F    Monitor CPU Temp. at 80°C / 176°F.
- ▶▶ 90°C / 194°F    Monitor CPU Temp. at 90°C / 194°F.
- ▶▶ Disabled        Disable this function. (Default Value)

☞ **Fan Fail Alarm**

CPU / Power / System

- ▶▶ No          Fan Fail Alarm Function Disable. (Default Value)
- ▶▶ Yes         Fan Fail Alarm Function Enable.

☞ **Current CPU Temp.**

- ▶▶ Detect CPU Temp. automatically.

☞ **Current System Temp.**

- ▶▶ Detect System Temp. automatically.

☞ **Current CPU Fan / System Fan / Power Fan Speed (RPM)**

- ▶▶ Detect Fan speed status automatically.

☞ **Current CPU VID / Vcore / Vcc18 / Vio / +12 / +5V / Battery / +5VSB**

- ▶▶ Detect system's voltage status automatically.

## Set Supervisor / User Password

When you select this function, the following message will appear at the center of the screen to assist you in creating a password.

AMBIOS SIMPLE SETUP UTILITY - VERSION 2.00 (C) 2001 American Megatrends, Inc. All Rights Reserved	
STANDARD CMOS SETUP	INTEGRATED PERIPHERALS
BIOS FEATURES SETUP	HARDWARE MONITOR & MISC SETUP
CHIPSET FEATURES SETUP	SUPERVISOR PASSWORD
POWER MANAGEMENT SETUP	USER PASSWORDS
PNP / PCI CONFIGURATION	
LOAD FAIL-SAFE DEFAULTS	SAVE & EXIT SETUP
LOAD OPTIMIZED DEFAULTS	EXIT WITHOUT SAVING
ESC: Quit      ↑↓←→ : Select Item      (Shift)F3 : Select Language      F5: Old Values F6: Fail-Safe Values      F7: Optimized Values      F8: Flash Utility      F10: Save & Exit	
Current Language: English	
Change / Set / Disable Password	

Figure 11: Password Setting

Type the password, up to six characters, and press <Enter>. You will be asked to confirm the password. Type the password again and press <Enter>. You may also press <Esc> to abort the selection and not enter a password.

To disable password, just press <Enter> when you are prompted to enter password. A message "PASSWORD DISABLED" will appear to confirm the password being disabled. Once the password is disabled, the system will boot and you can enter Setup freely.

The BIOS Setup program allows you to specify two separate passwords: a SUPERVISOR PASSWORD and a USER PASSWORD. When disabled, anyone may access all BIOS Setup program function. When enabled, the Supervisor password is required for entering the BIOS Setup program and having full configuration fields, the User password is required to access only basic items.

If you select "Always" at "Password Check" in BIOS Features Setup Menu, you will be prompted for the password every time the system is rebooted or any time you try to enter Setup Menu.

If you select "Setup" at "Password Check" in BIOS Features Setup Menu, you will be prompted only when you try to enter Setup.

## IDE HDD Auto Detection

AMIBIOS SETUP - STANDARD CMOS SETUP																																									
( C ) 2001 American Megatrends, Inc. All Rights Reserved																																									
System Date: Aug 01 2001 Wed																																									
System Time: 14:44:35																																									
<table border="1"> <thead> <tr> <th>TYPE</th> <th>SIZE</th> <th>CYLS</th> <th>HEAD</th> <th>PRECOMP</th> <th>LANDZ</th> <th>SECTOR</th> <th>MODE</th> </tr> </thead> <tbody> <tr> <td>Pri Master</td> <td>: Auto</td> <td></td> <td></td> <td></td> <td></td> <td></td> <td></td> </tr> <tr> <td>Pri Slave</td> <td>: Auto</td> <td></td> <td></td> <td></td> <td></td> <td></td> <td></td> </tr> <tr> <td>Sec Master</td> <td>: Auto</td> <td></td> <td></td> <td></td> <td></td> <td></td> <td></td> </tr> <tr> <td>Sec Slave</td> <td>: Auto</td> <td></td> <td></td> <td></td> <td></td> <td></td> <td></td> </tr> </tbody> </table>		TYPE	SIZE	CYLS	HEAD	PRECOMP	LANDZ	SECTOR	MODE	Pri Master	: Auto							Pri Slave	: Auto							Sec Master	: Auto							Sec Slave	: Auto						
TYPE	SIZE	CYLS	HEAD	PRECOMP	LANDZ	SECTOR	MODE																																		
Pri Master	: Auto																																								
Pri Slave	: Auto																																								
Sec Master	: Auto																																								
Sec Slave	: Auto																																								
Floppy Drive A : 1.44 MB 3 <sup>1/2</sup>	Base Memory : 640 Kb																																								
Floppy Drive B : Not Installed	Other Memory : 384 Kb																																								
Virus Protection : Disabled	Extended Memory : 255 Mb																																								
	Total Memory : 256 Mb																																								
Date is standard format	ESC : Exit																																								
Month : Jan - Dec	↑↓ : Select Item																																								
Day : 01- 31	PU / PD / + / - :Modify																																								
Year : 1990 - 2099	(Shift) F3 : Select Language																																								

Figure 12: IDE HDD Auto Detection

Type "Y" will accept the H.D.D. parameter reported by BIOS.

Type "N" will keep the old H.D.D. parameter setup. If the hard disk cylinder number is over 1024, then the user can select LBA mode or LARGER mode for DOS partition larger than 528 MB.

## Save & Exit Setup

AMBIOS SIMPLE SETUP UTILITY - VERSION 2.00 (C) 2001 American Megatrends, Inc. All Rights Reserved	
STANDARD CMOS SETUP	INTEGRATED PERIPHERALS
BIOS FEATURES SETUP	HARDWARE MONITOR & MISC SETUP
CHIPSET FEATURES SETUP	SUPERVISOR PASSWORD
POWER MANAGEMENT SETUP	USER PASSWORD
PNP / PCI CONF	SAVE & EXIT SETUP
LOAD FAIL-SAFE DEFAULTS	EXIT WITHOUT SAVING
LOAD OPTIMIZED DEFAULTS	
ESC: Quit    ↑↓←→ : Select Item    (Shift)F3 : Select Language    F5: Old Values	
F6: Fail-Safe Values    F7: Optimized Values    F8: Flash Utility    F10: Save & Exit	
Current Language: English	
Save Data to CMOS & Exit SETUP	

Figure 13: Save & Exit Setup

Type "Y" will quit the Setup Utility and save the user setup value to RTC CMOS.

Type "N" will return to Setup Utility.

## Exit Without Saving

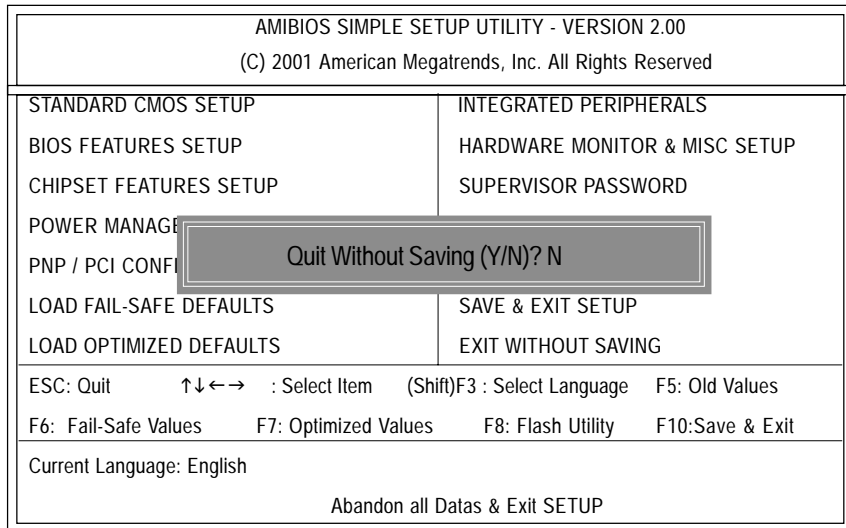

Figure 14: Exit Without Saving

Type "Y" will quit the Setup Utility without saving to RTC CMOS.

Type "N" will return to Setup Utility.

# Chapter 4 Technical Reference

## Performance List

The following performance data list is the testing results of some popular benchmark testing programs. These data are just referred by users, and there is no responsibility for different testing data values gotten by users. (The different Hardware & Software configuration will result in different benchmark testing results.)

CPU	Intel Pentium® 4 2GHz processor
DRAM	(128 x 2) MB RAM (SAMSUNG MR16R0828AN1-CK7)
CACHE SIZE	256KB included in CPU
DISPLAY	Gigabyte GV-GF3000D
STORAGE	Onboard IDE (Quantum AS30000AT 30GB)
O.S	Windows 2000+ SP2
DRIVER	Display Driver at 1024 x 768 x 64K colors x 75Hz. IUCD ver. 1.8 For Intel chipset M.B.
<hr/>	
<b>Processor</b>	Intel Pentium® 4 2GHz (100x20)
<hr/>	
<b>WCPUID 2.8 Clock Frequency</b>	
Internal MHz	1992.60
<hr/>	
<b>SiSoft Sandra 2001</b>	
CPU/FPU Benchmark	3791/(1038/2433)
CPU Multi-Media Benchmark	7893/9630
Drives Benchmark	22594
Memory Benchmark	1159/1192
<hr/>	
<b>SPECviewperf 6.12</b>	
Pro CDRS-03	14.91
MedMCAD-01	21.78
Light-04	5.978
DX-06	15.48
DRV-07	17.93
Awadvs-04	41.56
<hr/>	
<b>QUAKE III Arena (without sound)</b>	
640*480*16 Demo1	200.6
1024*768*32 Demo2	138.9
<hr/>	

# Block Diagram

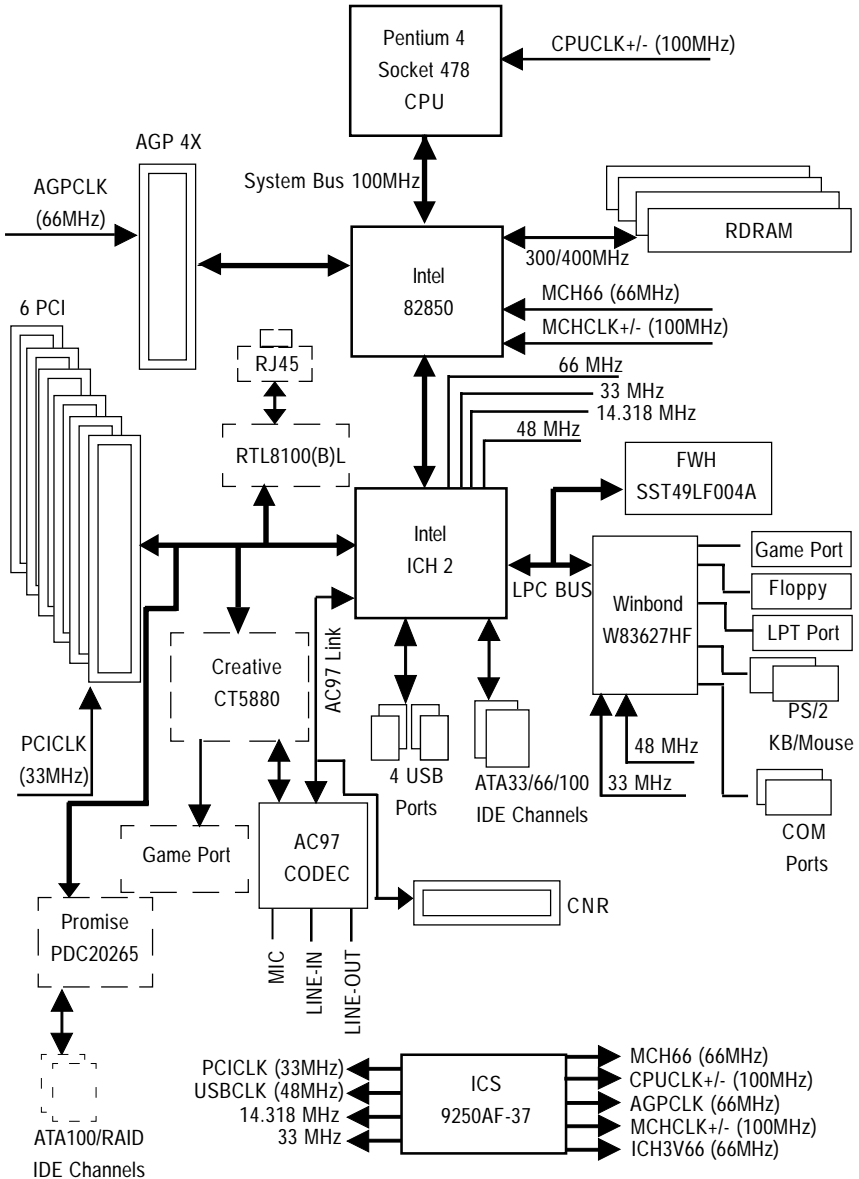



## Dual BIOS Introduction (For GA-8ITXR Only)

### A. What is Dual BIOS Technology?

Dual BIOS means that there are two system BIOS (ROM) on the motherboard, one is the Main BIOS and the other is Backup BIOS. Under the normal circumstances, the system works on the Main BIOS. If the Main BIOS is corrupted or damaged, the Backup BIOS can take over while the system is powered on. This means that your PC will still be able to run stably as if nothing has happened in your BIOS.

### B. How to use Dual BIOS and Q-Flash Utility?

a. After power on the computer, pressing <Del> immediately during POST (Power On Self Test) it will allow you to enter AMI BIOS CMOS SETUP, then press <F8> to enter Flash utility.

AMIBIOS SIMPLE SETUP UTILITY - VERSION 2.00 (C) 2001 American Megatrends, Inc. All Rights Reserved	
STANDARD CMOS SETUP BIOS FEATURES SETUP CHIPSET FEATURES SETUP POWER MANAGEMENT SETUP PNP / PCI CONFIGURATIONIDE LOAD FAIL-SAFE DEFAULTS LOAD OPTIMIZED DEFAULT	INTEGRATED PERIPHERALS HARDWARE MONITOR & MISC SETUP SUPERVISOR PASSWORD USER PASSWORD HDD AUTO DETECTION SAVE & EXIT SETUP EXIT WITHOUT SAVING
ESC: Quit      ↑↓←→ : Select Item      (Shift)F3 : Select Language      F5: Old Values F6: Fail-Safe Values      F7: Optimized Values <b>F8: Flash Utility</b> F10: Save & Exit	
Current Language: English <p style="text-align: center;">Time, Date , Hard Disk Type...</p>	

b. AMI Dual BIOS Flash ROM Programming Utility

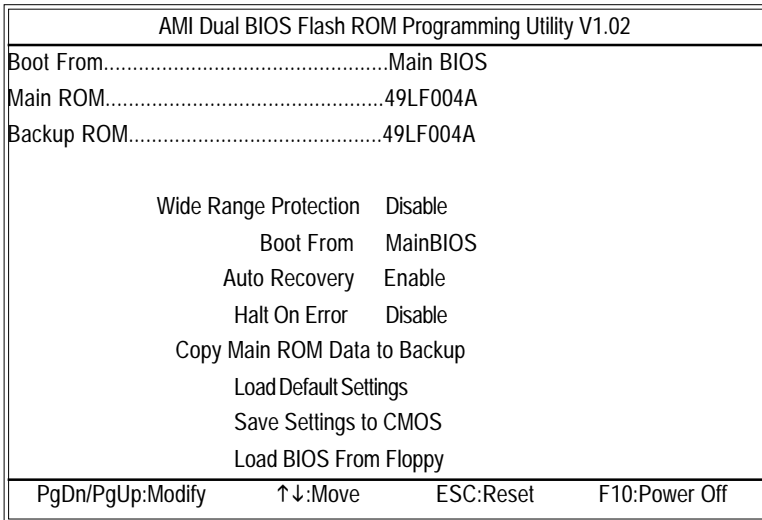

c. Dual BIOS Item explanation:

BIOS will auto detect:

Boot From : Main BIOS

Main ROM Type : 49LF004A

Backup ROM Type : 49LF004A

**Wide Range Protection: Disable(Default), Enable**

Status 1:

If any failure (ex. Update ESCD failure, checksum error or reset...) occurs in the Main BIOS , just before the Operating System is loaded and after the power is on, and that the Wide Range Protection is set to "Enable", the PC will boot from Backup BIOS automatically.

Status 2:

If the ROM BIOS on peripherals cards(ex. SCSI Cards, LAN Cards,..) emits signals to request restart of the system after the user make any alteration on it, the boot up BIOS will not be changed to the Backup BIOS.

### **Boot From : Main BIOS (Default), Backup BIOS**

Status 1:

The user can set to boot from main BIOS or Backup BIOS.

### **Auto Recovery : Enabled(Default), Disabled**

When one of the Main BIOS or Backup BIOS occurs checksum failure, the working BIOS will automatically recover the BIOS of checksum failure.

(In the Power Management Setup of the BIOS Setting, if ACPI Suspend Type is set to Suspend to RAM, the Auto Recovery will be set to Enable automatically.)

(If you want to enter the BIOS setting, please press "Del" key when the boot screen appears.)

### **Halt On Error : Disable(Default), Enable**

If the BIOS occurs a checksum error or the Main BIOS occurs a WIDE RANGE PROTECTION error and Halt On BIOS Defects set to Enable, the PC will show messages on the boot screen, and the system will pause and wait for the user's instruction.

If Auto Recovery: Disable, it will show <or the other key to continue.>

If Auto Recovery: Enable, it will show <or the other key to Auto Recover.>

### **Copy Main ROM Data to Backup**

Backup message:

**Are you sure to copy BIOS?**

**[Enter] to continue or [Esc] to abort...**

The means that the Main BIOS works normally and could automatically recover the Backup BIOS. Or the means that the Backup BIOS works normally and could automatically recover the Main BIOS.

(This auto recovery utility is set by system automatically and can't be changed by user.)

## **C. What is Q-Flash Utility?**

Q-Flash utility is a pre-O.S. BIOS flash utility enables users to update its BIOS within BIOS mode, no more fooling around any OS.

## D. How to use Q-Flash Flash?

### Load BIOS From Floppy

- ✎ In the A:drive, insert the "BIOS" diskette, then Press Enter to Run.
- ✎ Input BIOS file name in the text box. Press "Enter".

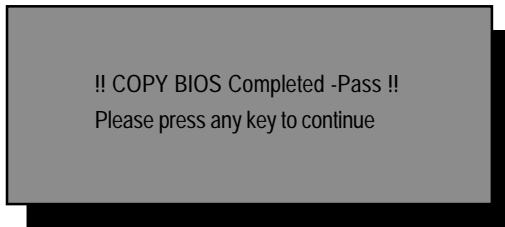
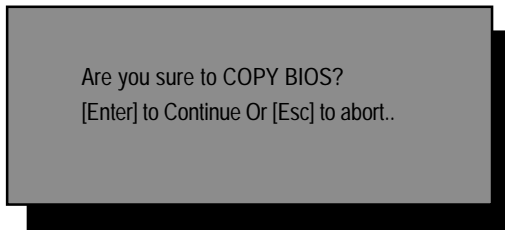
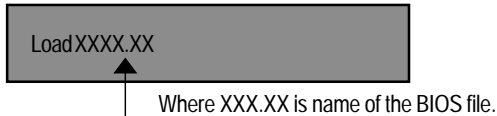

Congratulation! You have completed the flashed and now can restart system.



## DualBIOS™ Technology FAQ

GIGABYTE Technology is pleased to introduce DualBIOS technology, a hot spare for your system BIOS. This newest "Value-added" feature, in a long series of innovations from GIGABYTE, is available on this motherboard. Future GIGABYTE motherboards will also incorporate this innovation.

### **What's DualBIOS™?**

On GIGABYTE motherboards with DualBIOS there are physically two BIOS chips. For simplicity we'll call one your "Main BIOS" and the other we'll call your "Backup" BIOS (your "hot spare"). If your Main BIOS fails, the Backup BIOS almost automatically takes over on your next system boot. Almost automatically and with virtually zero down time! Whether the problem is a failure in flashing your BIOS or a virus or a catastrophic failure of the Main BIOS chip, the result is the same - the Backup BIOS backs you up, almost automatically.

## **I. Q: What is DualBIOS™ technology?**

### **Answer:**

DualBIOS technology is a patented technology from Giga-Byte Technology. The concept of this technology is based on the redundancy and fault tolerance theory. DualBIOS™ technology simply means there are two system BIOSes (ROM) integrated onto the motherboard. One is a main BIOS, and the other is a backup BIOS. The mainboard will operate normally with the main BIOS, however, if the main BIOS is corrupt or damaged for various reasons, the backup BIOS will be automatically used when the system powered-On. Your PC will operate as before the main BIOS was damaged, and is completely transparent to the user.

## **II. Q: Why does anyone need a motherboard with DualBIOS™ technology?**

### **Answer:**

In today's systems there are more and more BIOS failures. The most common reasons are virus attacks, BIOS upgrade failures, and/or deterioration of the BIOS (ROM) chip itself.

1. New computer viruses are being found that attack and destroy the system BIOS. They may corrupt your BIOS code, causing your PC to be unstable or even not boot normally.
2. BIOS data will be corrupted if a power loss/surge occurs, or if a user resets the system, or if the power button is pressed during the process of performing a system BIOS upgrade.
3. If a user mistakenly updates their mainboard with the incorrect BIOS file, then the system may not be able to boot correctly. This may cause the PC system hang in operation or during boot.
4. A flash ROM's life cycle is limited according to electronic characteristics. The modern PC utilizes the Plug and Play BIOS, and is updated regularly. If a user changes peripherals often, there is a slight chance of damage to the flash ROM.

With Giga-Byte Technology's patented DualBIOS™ technology you can reduce the possibility of hangs during system boot up, and/or loss BIOS data due to above reasons. This new technology will eliminate valuable system down time and costly repair bills cause by BIOS failures.

**III. Q: How does DualBIOS™ technology work?****Answer:**

1. DualBIOS™ technology provides a wide range of protection during the boot up procedure. It protects your BIOS during system POST, ESCD update, and even all the way to PNP detection/assignment.
2. DualBIOS™ provides automatic recovery for the BIOS. When the first BIOS used during boot up does not complete or if a BIOS checksum error occurs, boot-up is still possible. In the DualBIOS™ utility, the "Auto Recovery" option will guarantee that if either the main BIOS or backup BIOS is corrupted, the DualBIOS™ technology will use the good BIOS and correct the wrong BIOS automatically.
3. DualBIOS™ provides manual recovery for the BIOS. DualBIOS™ technology contains a built-in flash utility, which can flash your system BIOS from backup to main and/or visa versa. There is no need for an OS-dependent flash utility program.
4. DualBIOS™ contains a one-way flash utility. The built-in one-way flash utility will ensure that the corrupt BIOS is not mistaken as the good BIOS during recovery and that the correct BIOS (main vs. backup) will be flashed. This will prevent the good BIOS from being flashed.

**IV. Q: Who Needs DualBIOS™ technology?****Answer:**

1. Every user should have DualBIOS™ technology due to the advancement of computer viruses.

Everyday, there are new BIOS-type viruses discovered that will destroy your system BIOS. Most commercial products on the market do not have solutions to guard against this type of virus intrusion. The DualBIOS™ technology will provide a state-of-the-art solution to protect your PC:

Case I.) Vicious computer viruses may wipe out your entire system BIOS. With a conventional single system BIOS PC, the PC will not be functional until it is sent for repairs.

Case II.) If the "Auto Recovery" option is enabled in the DualBIOS™ utility, and if a virus corrupts your system BIOS, the backup BIOS will automatically reboot the system and correct the main BIOS.

Case III.) A user may override booting from the main system BIOS. The DualBIOS™ utility may be entered to manually change the boot sequence to boot from the backup BIOS.

2. During or after a BIOS upgrade, if DualBIOS™ detects that the main BIOS is corrupt, the backup BIOS will take over the boot-up process automatically. Moreover, it will verify the main and backup BIOS checksums when booting-up. DualBIOS™ technology examines the checksum of the main and backup BIOS while the system is powered on to guarantee your BIOS operates properly.
3. Power Users will have the advantage of having two BIOS versions on their mainboard. The benefit is being able to select either version BIOS to suit the performance system needs.
4. Flexibility for high-end desktop PCs and workstation/servers. In the DualBIOS™ utility, the option can be set, "Halt On When BIOS Defects," to be enabled to halt your system with a warning message that the main BIOS has been corrupted. Most workstation/servers require constant operation to guarantee services have not been interrupted. In this situation, the "Halt On When BIOS Defects" message may be disabled to avoid system pauses during normal booting. Another advantage you gain from Giga-Byte's DualBIOS™ technology is the ability to upgrade from dual 2 Mbit BIOS to dual 4 Mbit BIOS in the future if extra BIOS storage is need.



# Four Speaker & SPDIF Introduction(For GA-8ITXR Only)

## Four Speaker Introduction

### A. What is Four Speaker?

The Creative CT5880 audio chip can support up to 4 speaker output. If you select "Four speaker out", Line In will be reconfigured as another line out to support a second pair of speakers.

### B. How to use Four Speaker?

Microsoft Windows 98 Second Edition setup procedure:

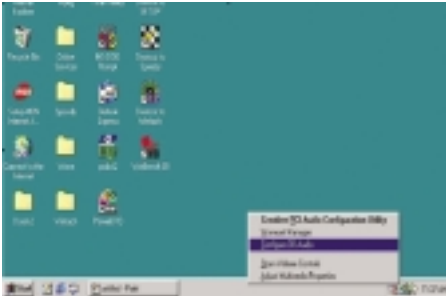

Click the audio icon along the task bar and select "Configure 3D Audio"

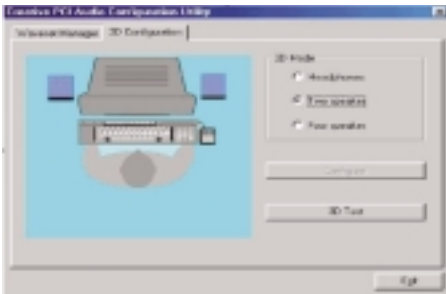

Select two speaker (Default)

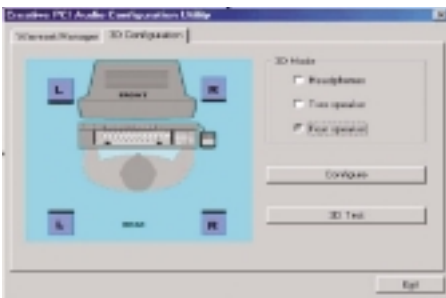

Select "Four speaker" item.

### Microsoft Windows Me setup procedure:



Go to "Control Panel" and double click "Sounds and Multimedia".

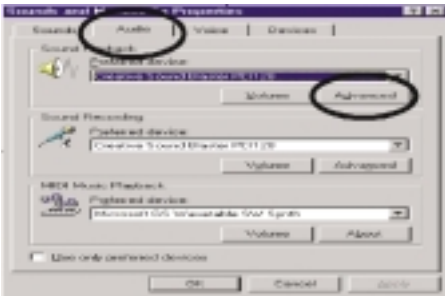

Select "Audio" Page, and click "Advanced" button.

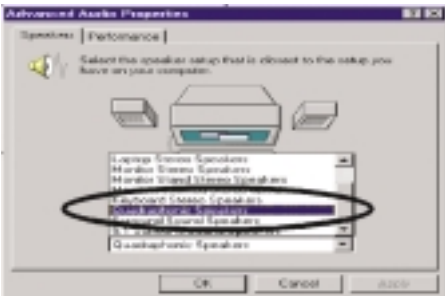

Select "Quadraphonic Speakers" and click ok.

### C. Four Speaker Application

The four speaker function will only be supported in application softwares that use Microsoft DirectX and Creative EAX, for example, the game titles, software DVD player and MP3 player.

## SPDIF Introduction

### A. What is SPDIF?

The SPDIF output is capable of providing digital signal to AC3 decoder which can support upto 5.1 speakers.

### B. How to use SPDIF?

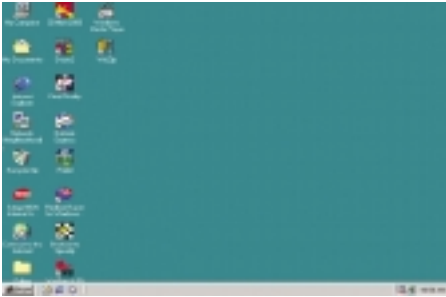

Click your mouse right button in "My Computer" and select the "Properties" item.

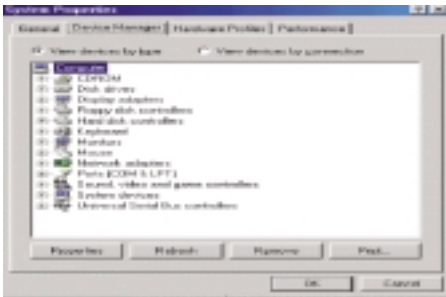

Click "Device Manager" item.

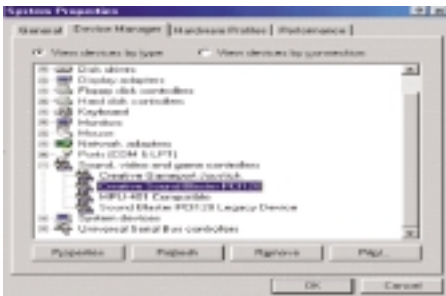

Click "Sound, video and game controllers" item and select the "Creative Sound Blaster PCI128" item.

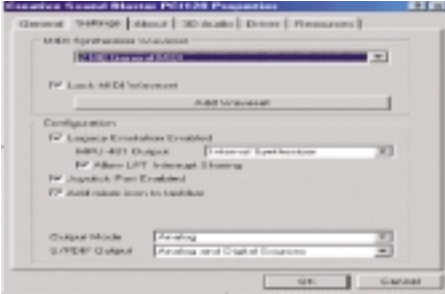

Click "Settings" item and select the "Output Mode" item.

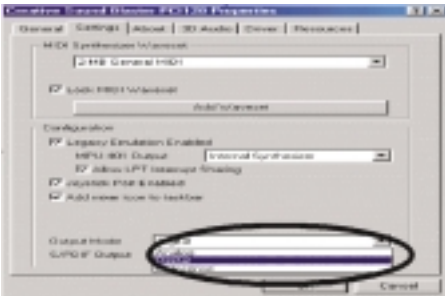

Click "Digital" item, Line Out will be reconfigure to SPDIF Out.

Recommend you to select "Autosense", It will automatically detect the type (mono or stereo) of the audio connector that you plug into Line Out audio jack, then configure Line Out to either SPDIF or Speaker accordingly.

## @ BIOS Introduction

### Gigabyte announces @ BIOS

### Windows BIOS live update utility



Have you ever updated BIOS by yourself? Or like many other people, you just know what BIOS is, but always hesitate to update it? Because you think updating newest BIOS is unnecessary and actually you don't know how to update it.

Maybe not like others, you are very experienced in BIOS updating and spend quite a lot of time to do it. But of course you don't like to do it too much. First, download different BIOS from website and then switch the operating system to DOS mode. Secondly, use different flash utility to update BIOS. The above process is not a interesting job. Besides, always be carefully to store the BIOS source code correctly in your disks as if you update the wrong BIOS, it will be a nightmare.

Certainly, you wonder why motherboard vendors could not just do something right to save your time and effort and save you from the lousy BIOS updating work? Here it comes! Now Gigabyte announces @BIOS—the first Windows BIOS live update utility. This is a smart BIOS update software. It could help you to download the BIOS from internet and update it. Not like the other BIOS update software, it's a Windows utility. With the help of "@BIOS", BIOS updating is no more than a click.

Besides, no matter which mainboard you are using, if it's a Gigabyte's product\*, @BIOS help you to maintain the BIOS. This utility could detect your correct mainboard model and help you to choose the BIOS accordingly. It then downloads the BIOS from the nearest Gigabyte ftp site automatically. There are several different choices; you could use "Internet Update" to download and update your BIOS directly. Or you may want to keep a backup for your current BIOS, just choose "Save Current BIOS" to save it first. You make a wise choice to use Gigabyte, and @BIOS update your BIOS smartly. You are now worry free from updating wrong BIOS, and capable to maintain and manage your BIOS easily. Again, Gigabyte's innovative product erects a milestone in mainboard industries.

For such a wonderful software, how much it costs? Impossible! It's free! Now, if you buy a Gigabyte's motherboard, you could find this amazing software in the attached driver CD. But please remember, connected to internet at first, then you could have a internet BIOS update from your Gigabyte @BIOS.

## Easy Tunelll™ Introduction

### **Gigabyte announces *EasyTuneIII* Windows overdrive utility**



“Overdrive” might be one of the most common issues in computer field. But have many users ever tried it? The answer is probably “no”. Because “overdrive” is thought to be very difficult and includes a lot of technical know-how, sometimes “overdrive” is even considered as special skills found only in some enthusiasts.

But as to the experts in “overdrive”, what’s the truth? They may spend quite a lot of time and money to study, try and use many different hardware and software tools to do “overdrive”. And even with these technologies, they still learn that it’s quite a risk because the safety and stability of an “overdrive” system is unknown.

Now everything is different because of a Windows overdrive utility EasyTuneIII—announced by Gigabyte. This utility has totally changed the gaming rule of “overdrive”. This is the first overdrive utility suitable for both normal and power users. Users can choose either “Easy Mode” or “Advanced Mode” to run “overdrive” at their convenience. For users who choose “Easy Mode”, they just need to click “Auto Optimize” to have auto and immediate CPU overclocking. This software will then overdrive CPU speed automatically with the result being shown in the control panel. If someone prefers to “overdrive” by oneself, there is also another choice. Click “Advanced Mode” to enjoy “sport drive” class overclocking. In “Advanced Mode”, one can change the system bus speed in small increments to get ultimate system performance. And no matter which mainboard is used, if it’s a Gigabyte’s product”, EasyTuneIII helps to perform the best of system.

Besides, different from other traditional over-clocking methods, EasyTuneIII doesn’t require users to change neither BIOS nor hardware switch/jumper setting; on the other hand, they can do “overdrive” at only one click. Therefore, this is a safer way for “overdrive” as nothing is changed on software or hardware. If user runs EasyTuneIII over system’s limitation, the biggest lost is only to restart the computer again and the side effect is then well controlled. Moreover, if one well-performed system speed been tested in EasyTuneIII, user can “Save” this bus speed and “Load” it in next time. Obviously, Gigabyte EasyTuneIII has already turned the “overdrive” technology toward to a newer generation.

This wonderful software is now free bundled in Gigabyte motherboard attached driver CD. Users may make a test drive of “EasyTuneIII” to find out more amazing features by themselves.

## RAID Introduction(For GA-8ITXR Only)

### What is RAID?

This motherboard implements two different types of RAID levels as follows:

#### **RAID 0 (stripe)**

For capacity -- The motherboard array will be as big as the smallest HDD in the array times however many HDDs are in the array. Any larger HDDs will simply be truncated. The truncated space on the bigger HDDs will then be unusable.

For sustained data transfers -- A RAID 0 array consisting of two HDDs will transfer at about twice the speed of the slowest HDD in the array. A RAID 0 array consisting of four HDDs will transfer at about three times the speed of the slowest HDD in the array.

#### **RAID 1 (mirror)**

For capacity - This Motherboard array will be as big as the smallest HDD in the array. The larger HDD will simply be truncated. The truncated space on the bigger HDD will then be unusable.

For sustained data transfers -- This motherboard array will write data at the rate of the slowest HDD in the array. This motherboard array will read data at twice the rate of the slowest HDD in the array.

## About RAID Levels

### Striping (RAID 0)

Reads and writes sectors of data interleaved between multiple drives. When any disk member fails, it affects the entire array. Performance is better than a single drive since the workload is balanced between the array members. This array type is for high performance systems. Identical drives are recommended for performance as well as data storage efficiency. The disk array data capacity is equal to the number of drive members times the smallest member capacity. For example, one 1GB and 1 drives will form a 2GB (2 x 1GB) disk array.

Stripe Size - a value can be set from 1KB to 1024KB sector size. The size can directly affect performance. In the FastBuild BIOS, the "Desktop" default is 8KB while "Server" and "AV Editing" are 64KB.

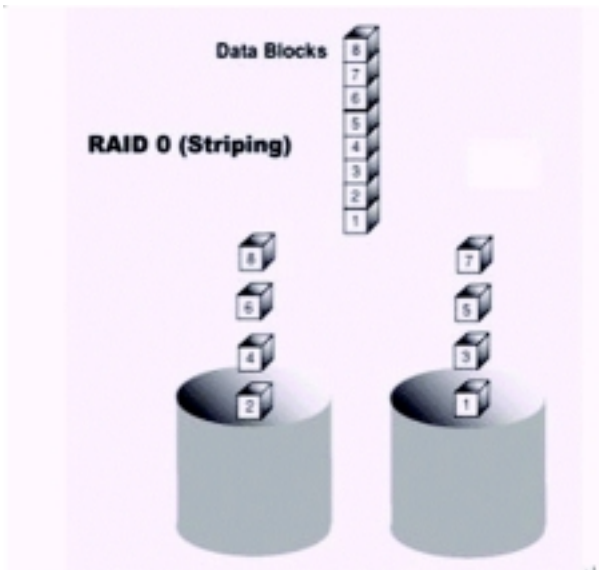



### Mirroring (RAID 1)

Writes duplicate data on to a pair of drives while reads are performed in parallel. ATA RAID 1 is fault tolerant because each drive of a mirrored pair is installed on separate IDE channels. If one of the mirrored drives suffers a mechanical failure (e.g. spindle failure) or does not respond, the remaining drive will continue to function. This is called Fault Tolerance. If one drive has a physical sector error, the mirrored drive will continue to function.

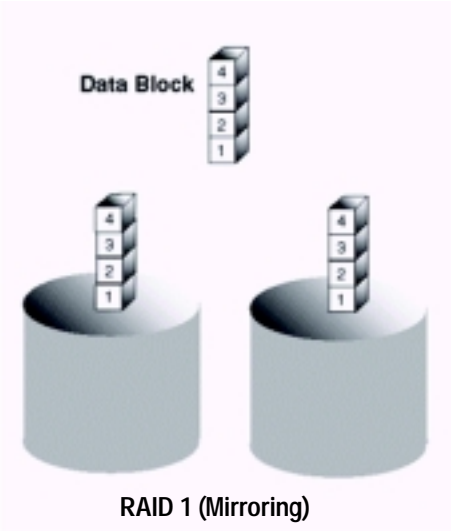

On the next reboot, the FastBuild™ utility will display an error in the array and recommend to replace the failed drive. Users may choose to continue using their PC, however Promise recommends replacing the failed drive as soon as possible. See Chapter 4 for a functional description.

Due to redundancy, the drive capacity of the array is half the total drive capacity. For example, two 1GB drives that have a combined capacity of 2GB would have 1GB of usable storage. With drives of different capacities, there may be unused capacity on the larger drive.

## Creating Your Disk Array

You will now use the FastBuild BIOS utility to create your array using the attached drives. There are two different scenarios in creating this array. You can create an array for performance, you can create a Security array using new hard drives (recommended).



**WARNING:** If creating a Security array using an existing hard drive, backup any necessary data. Failure to follow this accepted PC practice could result in data loss.

1. Boot your system. If this is the first time you have booted with RAID, the FastBuild BIOS will display the following screen.

```
FastTrak100 (tm) "Lite" BIOS Version 1.xx (Build xxxx)
(c) 1995-2000 Promise Technology, Inc. All Rights Reserved.
  No array defined . . .
Press <Ctrl-F> to enter FastBuild (tm) Utility
Or press <ESC> key to continue booting the system.
```

2. Press <Ctrl-F> keys to display the FastBuild (tm) Utility Main Menu
3. Press "1" to display the Auto Setup Menu below. This is the fastest and easiest method to creating your first array.

```
FastBuild (tm) Utility 1.xx (c) 1995-2000 Promise Technology, Inc.
[Auto Setup Options Menu]
Optimize Array for:           Performance
Typical Application usage:    A/V Editing
[ Auto Setup Configuration ]
Mode.....Stripe
Spare Driver.....0
Drives used in Array.....2
Array Disk Capacity.....16126
[ Keys Available ]
[↑] Up [↓] Down [←, →, Space] Change Option [ESC] Exit [Ctrl-Y] Save
```

## Creating an Array for Performance

NOTE: This motherboard allows users to create striped arrays with 1, 2 drives.

To create an array for best performance, follow these steps:

1. Using the Spacebar, choose "Performance" under the Optimize Array for section.
2. Select how you will use your PC most under the Typical Application usage section The choices are A/V Editing, Server, and Desktop (the default).
3. Press <Ctrl-Y> keys to Save and create the array.
4. Reboot your system.
5. Once the array has been created, you will need to FDISK and format the array as if it were a new single hard drive.
6. Proceed to Installing Drivers section of the manual (see RAID Manual of the IUCD).

## Creating a Security Array With New Drives

NOTE: This motherboard permit only two drives to be used for a single Mirrored array in Auto Setup.

To create an array for data protection using new hard drives, follow these steps:

1. Using the Spacebar, choose "Security" under the Optimize Array for section.
2. Press <Ctrl-Y> keys to Save your selection.
3. The window below will appear.

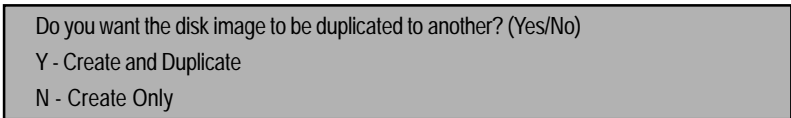

Do you want the disk image to be duplicated to another? (Yes/No)  
Y - Create and Duplicate  
N - Create Only

4. Press "N" for the Create Only option.
5. A window will appear almost immediately confirming that your Security array has been created. Press any key to reboot the system

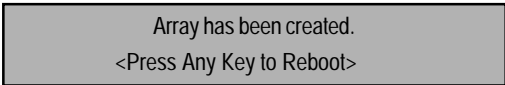

Array has been created.  
<Press Any Key to Reboot>

6. Proceed with normal FDISK and format procedures as if you had just installed a new hard drive.
7. Once the arrayed drives have been formatted, proceed to the Installing Driver chapter (see RAID Manual of the IUCD) to install your operating system.

## Creating a Security Array With An Existing Data Drive

NOTE: This motherboard permits only two drives to be used for a single Mirrored array in Auto Setup.

You would use this method if you wish to use a drive that already contains data and/or is the bootable system drive in your system. You will need another drive of identical or larger storage capacity.



WARNING: Backup any necessary data before proceeding. Failure to follow this accepted PC practice could result in data loss.



WARNING: If you wish to include your current bootable drive using the Windows NT 4.x or Windows 2000 operating system as part of a bootable Mirrored (RAID 1) array on your system, do NOT connect the hard drive to the motherboard controller yet. You MUST install the Windows NT4 or 2000 driver software first (see RAID Manual of the IUCD) to this drive while it is still attached to your existing hard drive controller. For all other Operating Systems, proceed here.

Follow these steps:

1. Using the Spacebar, choose "Security" under the Optimize Array for section.
2. Press <Ctrl-Y> keys to Save your selection. The window below will appear.

Do you want the disk image to be duplicated to another? (Yes/No)  
Y - Create and Duplicate  
N - Create Only

3. Press "Y" for the Create and Duplicate option. The window below will appear asking you to select the Source drive to use. FastBuild will copy all data from the Source drive to the Target drive.

Source Disk		
Channel:ID	Drive Model	Capacity (MB)
TargetDisk		
Channel:ID	Drive Model	Capacity (MB)
[Please Select A Source Disk]		
Channel:ID	Drive Model	Capacity (MB)
1 :Master	QUANTUMCR8.4A	8063
2 :Master	QUANTUMCR8.4A	8063
[↑] Up [↓] [ESC] Exit [Ctrl-Y] Save		

4. Use the arrow keys to choose which drive contains the existing data to be copied.
5. Press [Ctrl-Y] keys to Save selection and start duplication. The following progress screen will appear.

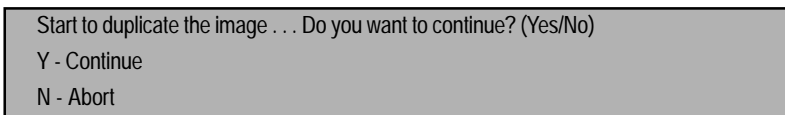

Start to duplicate the image . . . Do you want to continue? (Yes/No)  
Y - Continue  
N - Abort

6. Select "Y" to continue. If you choose "N" , you will be returned to step 1.
7. Once complete, the following screen will appear confirming that your Security array has been created. Press any key to reboot the system

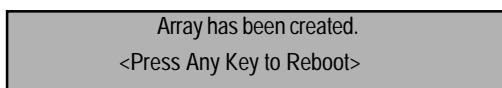

Array has been created.  
<Press Any Key to Reboot>

8. Proceed to the Installing Driver chapter (see RAID Manual of the IUCD) to install the RAID driver and/or operating system.

## Using FastBuild™ Configuration Utility

The FastBuild™ Configuration Utility offers several menu choices to create and manage the drive array on the motherboard. For purposes of this manual, it is assumed you have already created an array in the previous chapter and now wish to make a change to the array or view other options.

### Viewing BIOS Screen

When you boot your system with the RAID function and drives installed, the FastBuild BIOS will detect the drives attached and show the following screen.

```
FastTrak100 (tm)"Lite" BIOS Version 1.xx (Build xx)
(c) 1995-2000 Promise Technology, Inc. All Rights Reserved.
  Scanning IDE drives . . . . .
```

If an array exists already, the BIOS will display the following screen showing the board RAID BIOS version and status of the array.

```
FastTrak100 (tm) "Lite"BIOS Version 1.xx (Build xxxx)
(c) 1995-2000 Promise Technology, Inc. All Rights Reserved.
  ID  MODE  SIZE          TRACK-MAPPING          STATUS
  1 *  1*2 Mirror      16126M 611/128/32      Functional
  Press <Ctrl-F> to enter FastBuild (tm) Utility....
```

The array status consists of three possible conditions: Functional, Critical, Offline.

Functional - The array is operational.

Critical - A mirrored array contains a drive that has failed or disconnected. The remaining drive member in the array is functional. However, the array has temporarily lost its ability to provide fault tolerance. The user should identify the failed drive through the FastBuildO Setup utility, and then replace the problem drive.

Offline - A striped array has 1 drive that has failed or been disconnected. When the array condition is "offline," the user must replace the failed drive(s), then restore data from a backup source.

## Navigating the FastBuild™ Setup Menu

When using the menus, these are some of the basic navigation tips: Arrow keys highlights through choices; [Space] bar key allows to cycle through options; [Enter] key selects an option; [ESC] key is used to abort or exit the current menu.

## Using the Main Menu

This is the first option screen when entering the FastBuild™ Setup.

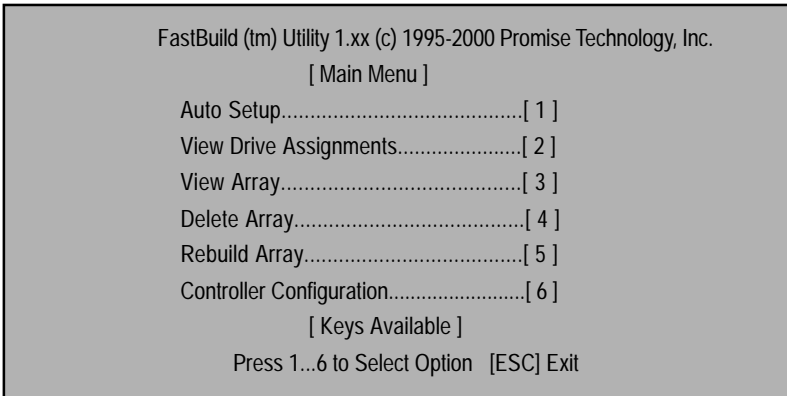

To create a new array automatically, follow the steps under "Creating Arrays Automatically" on page 84. Promise recommends this option for most users.

To view drives assigned to arrays, see "Viewing Drive Assignments" on page 86.

To delete an array (but not delete the data contained on the array), select "Deleting An Array" on page 93.

To rebuild a mirrored array, see "Rebuilding an Array" on page 95.

To view controller settings, see "Viewing Controller Configuration" on page 97.



**NOTE:** After configuring an array using FastBuild, you should FDISK and format the arrayed drive(s) if you are using new, blank drives. Depending on the type of array you are using.

## Creating Arrays Automatically

The Auto Setup <1> selection from the Main Menu can intuitively help create your disk array. It will assign all available drives appropriate for the disk array you are creating. After making all selections, use Ctrl-Y to Save selections. FastBuild will automatically build the array.

```
FastBuild (tm) Utility 1.xx (c) 1995-2000 Promise Technology, Inc.
                                     [Auto Setup Options Menu]
Optimize Array for:                   Performance
Typical Application usage: AV Editing
                                     [ Auto Setup Configuration ]
Mode.....Stripe
Spare Drive Count.....0
Drives used in Array.....2
Array Disk Capacity.....16126
                                     [ Keys Available ]
[↑] Up [↓] Down [←, →, Space] Change Option [ESC] Exit [Ctrl-Y] Save
```

### Optimize Array For

Select whether you want Performance (RAID 0), Security (RAID 1) under the "Optimize Array for" setting.

Performance (RAID 0 Striping)

Supports the maximum performance. The storage capacity equals the number of drives times the capacity of the smallest drive in the disk array.

NOTE: This motherboard permits striped arrays using 1, 2 drive attached in Auto Setup mode.

Security (RAID 1 Mirroring)

Creates a mirrored (or fault tolerant) array for data security.

NOTE: Under the Security setting, This motherboard permits two drives to be used for a single Mirrored array only.



### **Defining Typical Application Usage**

Allows the user to choose the type of PC usage that will be performed in order to optimize how This motherboard handles data blocks to enhance performance. Your choice will determine the block size used. You may choose from: A/V Editing (for audio/video applications, or any similar application that requires large file transfers), Server (for numerous small file transfers), or Desktop (a combination of large and small file sizes).

### **Creating Multiple Disk Arrays**

1. If you plan to create multiple arrays, attach only the drives necessary to create the first disk array and complete the <1> Auto Setup.
2. Install the additional drives needed for the second array and again use the <1> Auto Setup.

NOTE: If you wish to customize the settings of individual disk arrays (such as block size), you must manually create disk arrays with the Define Array <3> option from the Main Menu.

## Viewing Drive Assignments

The View Drive Assignments <2> option in the Main Menu displays whether drives are assigned to a disk arrays or are unassigned.

Under the "Assignment" column, drives are labeled with their assigned disk array or shown as "Free" if unassigned. Such "Free" drives can be used for a future array. Unassigned drives are not accessible by the OS. The menu also displays the data transfer mode that relates to speed used by each drive (U5 refers to 100MB/sec transfers, U4 refers to 66MB/sec transfers, etc...)

FastBuild (tm) Utility 1.xx (c) 1995-2000 Promise Technology, Inc.				
[ View Drive Assignments ]				
Channel:ID	Drive Model	Capacity(MB)	Assignment	Mode
1 : Master	QUANTUMCR8.4A	8063	Array 1	U5
1 : Slave	QUANTUMCR8.4A	8063	Free	U5
2 : Master	QUANTUMCR8.4A	8063	Array 1	U5

[ Keys Available ]

[↑] Up [↓] Down [ESC] Exit Mode (U=UDMA, P=PIO, D=DMA)

## Manually Creating an Array

The Define Array <3> option from the Main Menu allows users to begin the process of manually defining the drive elements and RAID levels for one or multiple disk arrays attached to this motherboard. Users will commonly create one or two drive arrays with the motherboard, though the motherboard will support a maximum of four arrays .

NOTE: For most installations, We recommends the <1> Auto Setup for easy disk array creation.

FastBuild (tm) Utility 1.xx (c) 1995-2000 Promise Technology, Inc.				
[Define Array Menu]				
Array No	RAID Mode	Total Drv	Capacity(MB)	Status
Array 1	Stripe	2	16126	Functional
Array 2	----	----	----	----
Array 3	----	----	----	----
Array 4	----	----	----	----
[ Keys Available ]				
Note: * - Bootable Array				
[↑] Up [↓] Down [ESC] Exit [Enter] Select [Space] Change Boot Drive				

1. To manually create an array from the Define Array Menu, use the arrow keys to highlight the array number you wish to define, and press [Enter] to select.
2. The Define Array Definition Menu will next appear that allows drive assignments to the disk array (see next page).

<sup>1</sup> A user may use a single drive in either striping mode with system. In this rare scenario, the motherboard will create an individual array ID but will offer conventional controller performance, depending on the drive type. At a later time, a second drive can be added to the array and the array re-created to support RAID 1 mirroring.

## Selecting Array Type

1. Under the Definition section of this menu, highlight the Array # for which you want to assign a RAID level.
2. Use the [Space] key to cycle through two array types: Performance (RAID 0 Striping), Security (RAID 1 Mirroring).

FastBuild (tm) Utility 1.xx (c) 1995-2000 Promise Technology, Inc.				
[ Define Array Definition Menu ]				
Array No	RAID Mode	Total Drv	Capacity(MB)	Status
Array 1	Stripe	2	16126	Functional
Stripe Block: 64 KB				
[ Drive Assignments ]				
Channel:ID	Drive Model	Capacity (MB)	Assignment	
1 :	Master QUANTUMCR8.4A	8063	Y	
1 :	Slave QUANTUMCR8.4A	8063	N	
2 :	Master QUANTUMCR8.4A	8063	Y	
[ Keys Available ]				
[↑] Up [↓] Down [ESC] Exit [Space] Select [Ctrl-Y] Save				

## Selecting Stripe Block

For RAID 0 Striped arrays only, you may manually select the "stripe block size." Use the Spacebar to scroll through choices progressing as follows (1, 2, 4, 8, 16 . . . 1024).

The size selected affects how montherboard sends and retrieves data blocks from the drives. You will need to perform your own testing to determine how the data block size is affecting your particular use of the array. In general, a larger block size is better when handling large data transfers (such as in A/V editing or graphics) while a smaller block size is better when handling e-mail and other common server data. The default is 64K.

## Assigning Drive(s) to Array

1. Under the [ Drive Assignments ] section, highlight a drive using the [↑] Up [↓] keys.
2. With the [Space] bar key, change the Assignable option to "Y" to add the drive to the disk array.

3. Press <Ctrl-Y> to save the disk array information. Depending on the array type selected, the following scenarios will take place:
  - a) If choosing a Striping array, the initial Define Array Menu screen will appear with the arrays defined. From there you may ESC to exit and return to the Main Menu of FastBuild.
  - b) If you selected a Mirroring array for two drives, there is an additional window that appears as described in order to create the array. To do this you will use either two brand new drives, or one drive that contains existing data that you wish to mirror.

### Creating A Mirrored Array Using New Drives

As described in the Drive Assignments Option section above, if you selected a mirroring array and wish to use two new assigned drives, follow the directions here.

1. After assigning new drives to a Mirroring array and saving the information with <Ctrl-Y>, the window below will appear.

Do you want the disk image to be duplicated to another? (Yes/No)  
 Y - Create and Duplicate  
 N - Create Only

2. Press "N" for the Create Only option.
3. A window will appear almost immediately confirming that your Security array has been created. Press any key to reboot the system

Array has been created.  
 <Press Any Key to Reboot>

### Adding Fault Tolerance to an Existing Drive

This motherboard will create a mirrored array using an existing system drive with data. You must assign the existing drive and another drive of same or larger capacity to the Mirroring array. The BIOS will send the existing data to the new blank drive.



**WARNING:** Backup any necessary data before proceeding. Failure to follow this accepted PC practice could result in data loss.



**WARNING:** If you wish to include your current bootable drive using the Windows NT 4.x or Windows 2000 operating system as part of a bootable Mirrored (RAID 1) array on your system, do NOT connect the hard drive to the system controller yet.

You MUST install the Windows NT4 or 2000 driver software first (see RAID Manual of the IUCD) to this drive while it is still attached to your existing hard drive controller. For all other Operating Systems, proceed here

After assigning the drives to a Mirroring array, press <Ctrl-Y> keys to Save your selection. The window below will appear.

Do you want the disk image to be duplicated to another? (Yes/No)  
Y - Create and Duplicate  
N - Create Only

1. Press "Y" for the Create and Duplicate option. The window below will appear asking you to select the Source drive to use. FastBuild will copy all data from the Source drive to the Target drive.

Source Disk		
Channel:ID	Drive Model	Capacity (MB)
	Target Disk	
Channel:ID	Drive Model	Capacity (MB)
[Please Select A Source Disk]		
Channel:ID	Drive Model	Capacity (MB)
1 :Master	QUANTUMCR8.4A	8063
2 :Master	QUANTUMCR8.4A	8063

[↑] Up [↓] Down [ESC] Exit [Ctrl-Y] Save

2. Use the arrow keys to choose which drive contains the existing data to be copied.



WARNING: All target drive data will be erased. Make sure you choose the correct drive.

3. Press [Ctrl-Y] keys to Save selection and start duplication. The following confirmation screen will appear.

Start to duplicate the image . . .  
Do you want to continue? (Yes/No)  
Y - Continue N - Abort

4. Select "Y" to continue. If you choose "N" , you will be returned to step 1.
5. Once "Y" is selected, the following progress screen will appear. The process will take a few minutes.

Please Wait While Duplicating The Image.

10% Complete

- Once mirroring is complete, the following screen will appear confirming that your Security array has been created. Press any key to reboot the system

```

Array has been created.
<Press Any Key to Reboot>
    
```

### Making a Disk Array Bootable



**WARNING:** In order for you to boot from an array on the system, your PC or server must be configured in the CMOS Setup to use the system as a bootable device (versus the onboard controller). This option is not available if the system is being used as a secondary controller.

- Once you have returned to the Define Array Menu window (below), you will see the array(s) you have created. You now may use the menu to select which previously-defined array will be used as the bootable array.

```

FastBuild (tm) Utility 1.xx DELL (c) 1995-2000 Promise Technology, Inc.
[ Define Array Menu ]
Array No      RAID Mode      Total Drv      Capacity(MB)      Status
* Array 1     Stripe         2              13044             Functional
Note: * - Bootable Array
[↑] Up [↓] Down [ESC] Exit [Enter] Select [Space] Change Boot Drive
    
```

- Highlight the array which you want to boot from using the [↑] Up [↓]Down keys.
  - Press the [Space] bar key.
  - An \* asterisk will appear next to the array number indicating it as bootable. The system will now recognize this array as the first array seen
  - The system will then use this bootable array as the (fixed) boot C: drive.
- NOTE:** The bootable array must contain your configured operating system.

### **How Orders Arrays**

During startup, the disk arrays on the motherboard are recognized in this order: 1) The array set to bootable in the FastBuild™ Setup, and 2) the Array number (i.e. Array 0, Array 1;K). This would be involved in determining which drive letters will be assigned to each disk array.

### **How Saves Array Information**

All disk array data is saved into the reserved sector on each array member. We suggests that users record their disk array information for future reference.

Another feature of the motherboard disk array system is to recognize drive members even if drives are moved between different motherboard connectors(IDE3&IDE4). Since each drive's array data identifies itself to the array, it is possible to move or swap drives without modifying the array setup. This is valuable when adding drives, or during a rebuild.



## Deleting An Array

The Delete Array <4> Menu option allows for deletion of disk array assignments. This is not the same as deleting data from the drives themselves. If you delete an array by accident (and before it has been used again), the array can normally be recovered by defining the array identically as the deleted array.



**WARNING:** Deleting an existing disk array could result in its data loss. Make sure to record all array information including the array type, the disk members, and stripe block size in case you wish to undo a deletion.

FastBuild (tm) Utility 1.xx (c) 1995-2000 Promise Technology, Inc.				
[ Delete Array Menu ]				
Array No	RAID Mode	Total Drv	Capacity(MB)	Status
Array 1	Mirror	2	8063	Functional
Array 2	Stripe	1	8063	Functional
Array 3	Stripe	1	8063	Functional
Array 4	----	----	----	----
[ Keys Available ]				
[↑] Up [↓] Down		[ESC] Exit	[Del] Delete	

1. To delete an array, highlight the Array you wish to delete and press the [Del] key.
2. The View Array Definition menu will appear (see below) showing which drives are assigned to this array.

FastBuild (tm) Utility 1.xx (c) 1995-2000 Promise Technology, Inc.				
[ Define Array Menu ]				
Array No	RAID Mode	Total Drv	Capacity(MB)	Status
Array 1	Mirror	2	8063	Functional
Stripe Block: 64 KB				
[ Drive Assignments ]				
Channel:ID	Drive Model	Capacity (MB)	Assignment	
1 : Master	QUANTUMCR8.4A	8063	Y	
2 : Master	QUANTUMCR8.4A	8063	Y	

3. Confirm yes to the following warning message with the <Ctrl-Y> key to continue array deletion:

Are you sure you want to delete this array?  
Press Ctrl-Y to Delete, others to Abort

4. After deleting the array, you should create a new array using Auto Setup or the Define Array menu from the FastBuild Main Menu.

## Rebuilding A Mirrored Array

The Rebuild Array <5> Menu option is necessary to recover from an error in a mirrored disk array. You will receive an error message when booting your system from the BIOS.

NOTE: Drives MUST be replaced if they contain any physical errors.

Follow these steps BEFORE using the Rebuild Array menu option:

1. On bootup, the system Startup BIOS will display an error message identifying which drive has failed.
2. Press <Ctrl-F> keys to enter FastBuild Main Menu.
3. Select submenu Define Array <3>.
4. Select the failed array and identify the Channel and ID of the failed drive.
5. Power off and physically remove the failed drive.
6. Replace the drive with an identical model.
7. Reboot the system and enter the FastBuild Main Menu.
8. Select the <5> Rebuild Array option. The following screen will appear.

FastBuild (tm) Utility 1.xx (c) 1995-2000 Promise Technology, Inc.				
[ Rebuild Array Menu ]				
Array No	RAID Mode	Total Drv	Capacity(MB)	Status
Array 1	Mirror	2	16126	Critical
Array 2	Stripe	1	8063	Functional
Array 3	Stripe	1	8063	Functional
Array 4	----	-----	-----	-----
[ Keys Available ]				
[↑] Up [↓] Down [ESC] Exit [Enter] Select				

9. Highlight the array whose Status is "Critical".
10. Press [Enter]. The following screen will then appear (see next page).

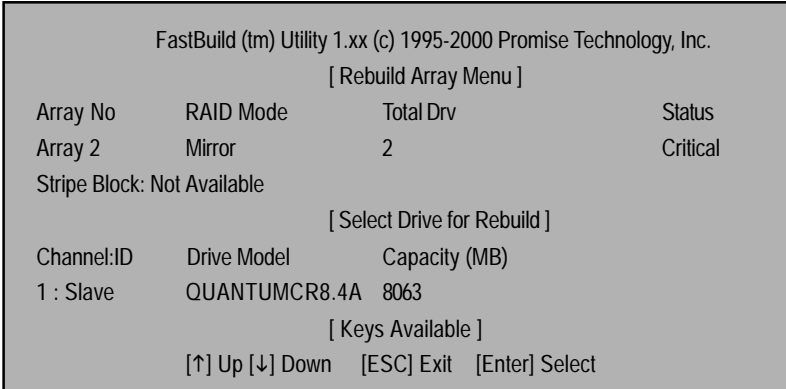

11. Under [Select Drive for Rebuild], highlight the replacement drive.
12. Press [Enter] and confirm that the data will be copied on to the selected drive. All data on the replacement drive will be written over with mirrored information from the array drive. A progress bar will appear as below.

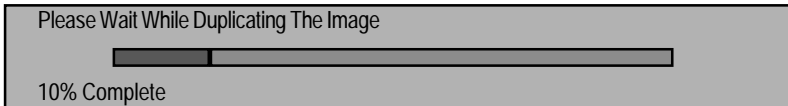

13. Once the rebuild process is complete, the user will be asked to reboot the system.

## Viewing Controller Settings

The Controller Configuration <6> menu selection allows you to enable or disable the BIOS from halting (the default) if it detects an error on boot up. You may also view the system resources (Interrupt and I/O port address) of data channels

```
FastBuild (tm) Utility 1.xx (c) 1995-2000 Promise Technology, Inc.
                                [ Adapter Configuration - Options ]
                                Halt On Error:  Enable
                                [ System Resources Configuration ]
Channel 1 (IDE1)                 Interrupt : A I/O Port : FFF0
Channel 2 (IDE2)                 Interrupt : A I/O Port : FFA8
                                [ Keys Available ]
                                [←, → Space] Change Option  [ESC] Exit
```

## Halting BIOS On Bootup Errors

The [Adapter Configuration - Options] section allows you to enable or disable The system to Halt operation at the BIOS startup screen should an error be detected. This is the only option that can be changed on this screen.

### Viewing System Resources

The [System Resources Configuration] section of this submenu displays the PCI slot interrupt and port address used by the system. The resources used are determined by the Mainboard PCI PnP BIOS for the PCI slot in which the system resides.

In the rare case that there is a resource conflict, refer to the Mainboard BIOS documentation on changes on resources allocated to the system PCI slot.

## Chapter 5 Appendix



**Warning!** In order to setup your system correctly, please install drivers in the following order.

Picture below are shown in Windows ME (IUCD driver version 1.81)

### Appendix A: Intel 850 Chipset Driver Installation (Part 1)

#### Windows 9x/ME/2000/XP INF Update Utility:

Insert the driver CD-title that came with your motherboard into your CD-ROM driver, the driver CD-title will auto start and show the installation guide. If not, please double click the CD-ROM device icon in "My computer", and execute the setup.exe.

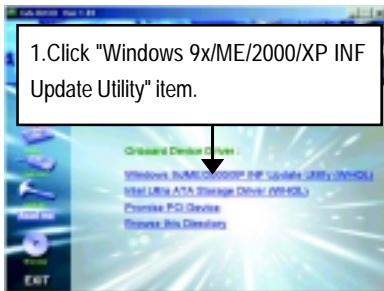

(1)

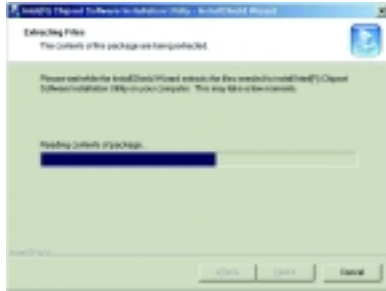

(2)

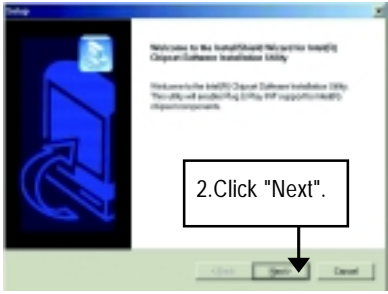
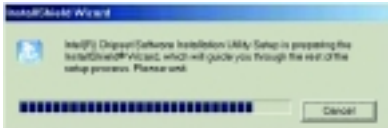

(3)

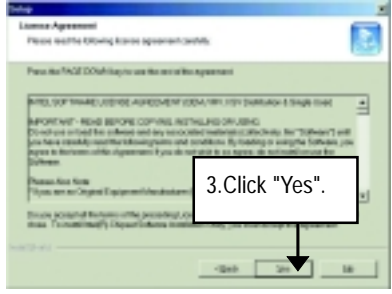

(4)

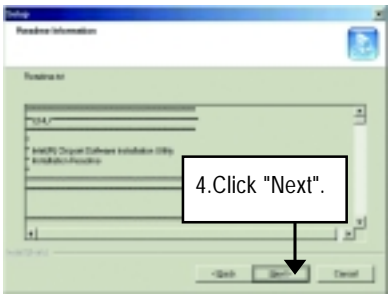

(5)



(6)



(7)

## Appendix B: AC97 Sound Chipset Driver

"AC'97 Audio Driver" under Windows ME will auto install.

## Appendix C: Creative CT5880 Chipset Driver Installation\* (8ITX skip the step)

Insert the driver CD-title that came with your motherboard into your CD-ROM driver, the driver CD-title will auto start and show the installation guide. If not, please double click the CD-ROM device icon in "My computer", and execute the setup.exe.



(1)



(2)

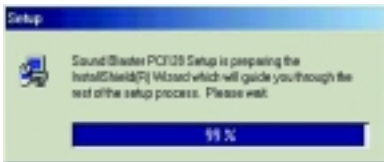

(3)

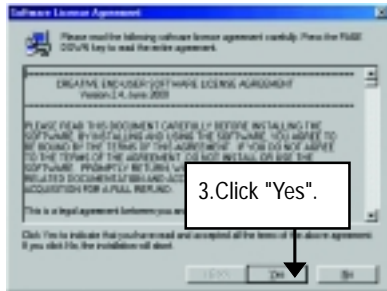

(4)

\*\*\* For GA-8ITXR only.



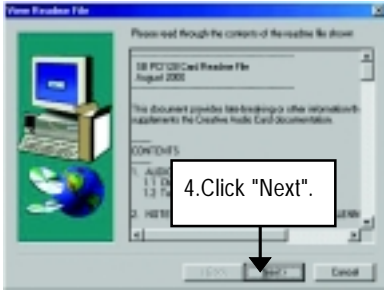

(5)

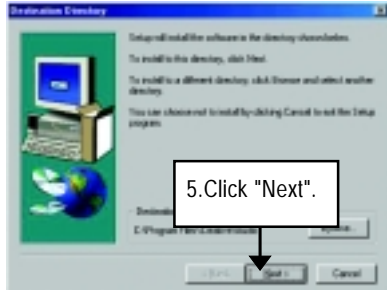

(6)

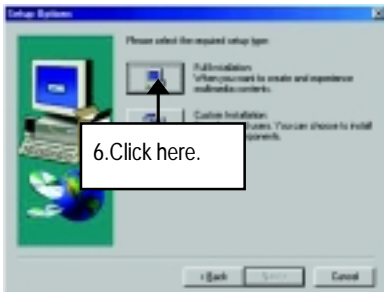

(7)

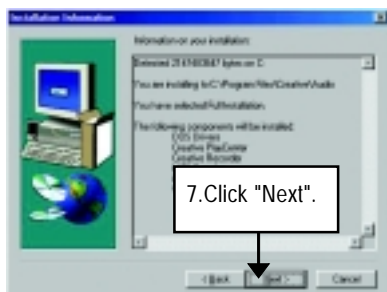

(8)

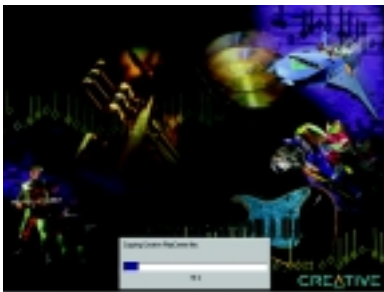

(9)

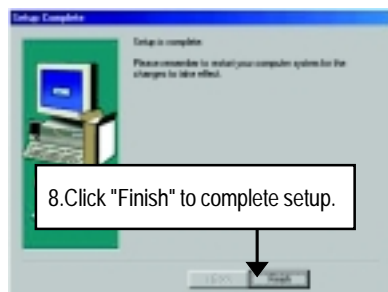

(10)

## Oozic Player Installation

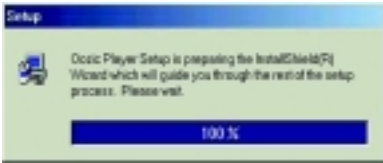

(1)

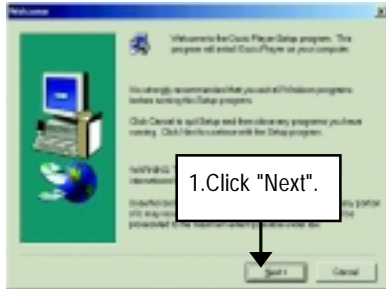

(2)

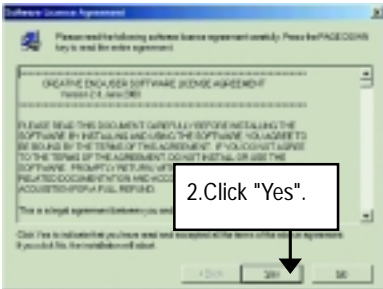

(3)

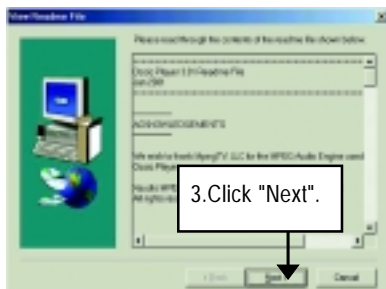

(4)

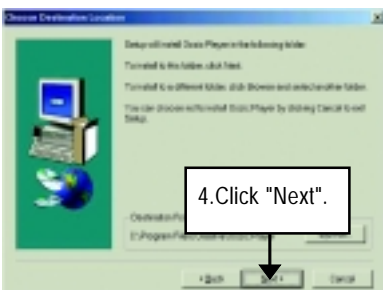

(5)

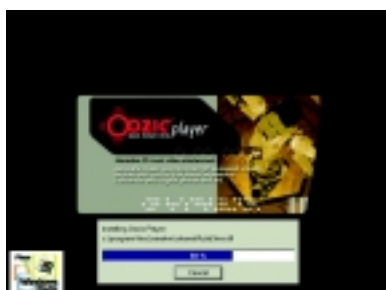

(6)

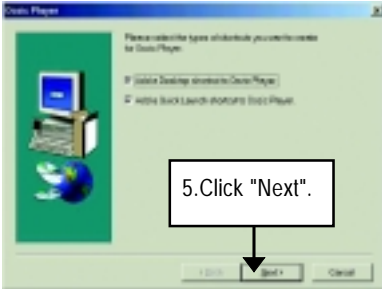

(7)



Please base on your actual requirement, select "Yes" or "No" accordingly.

(8)

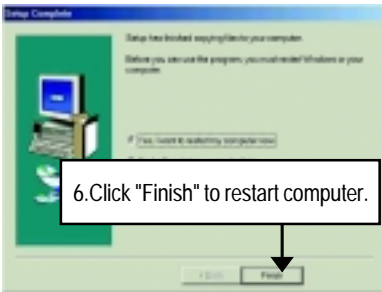

(9)

### Appendix D: RealTek 8139/8130/8100 Network Driver\* (8ITX skip the step)

"RealTek 8139/8130/8100 Network Driver" under Windows ME will auto install. If you would like to install LAN driver, please refer to attached README.txt file for detail instruction. Please install the driver through CD-ROM by the path D:\Network\Rtl (This manual assumes that your CD-ROM device drive letter is D:).

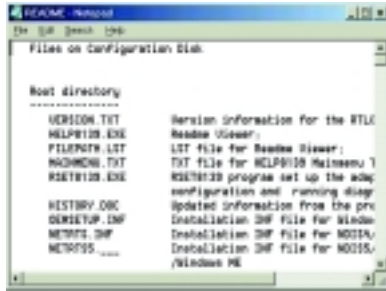

\*\*\* For GA-8ITXR only.

## Appendix E: Promise PCI Device Installation\* (8ITX skip the step)

### A.Promise ATA100 Driver Installation:

Insert the driver CD-title that came with your motherboard into your CD-ROM driver, the driver CD-title will auto start and show the installation guide. If not, please double click the CD-ROM device icon in "My computer", and execute the setup.exe.

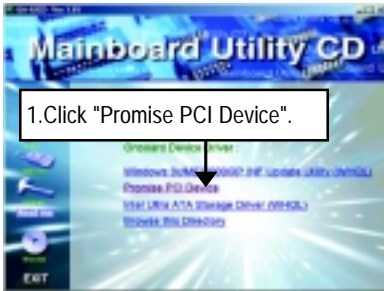

(1)

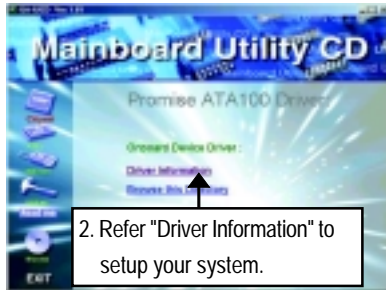

(2)

- For your reference, you can use the following steps to complete the Promise ATA100 Driver Installation.

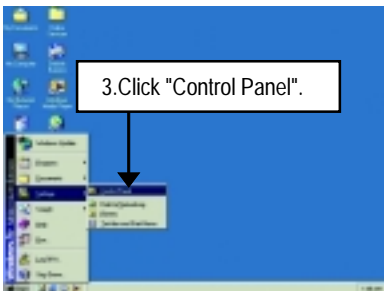

(3)

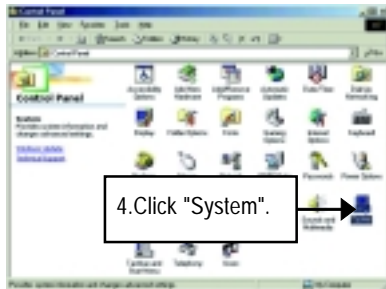

(4)

\*\*\* For GA-8ITXR only.



(5)

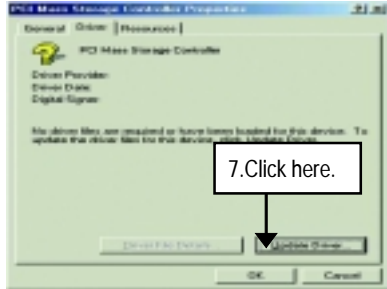

(6)

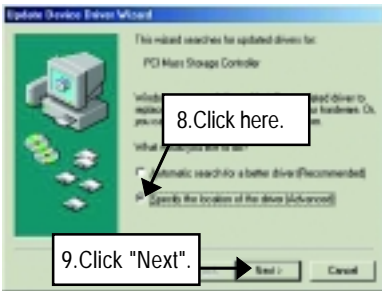

(7)

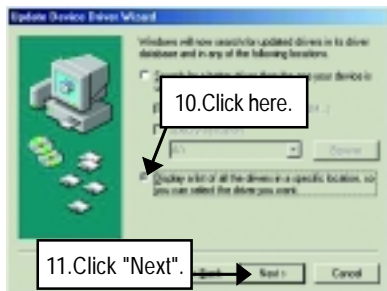

(8)

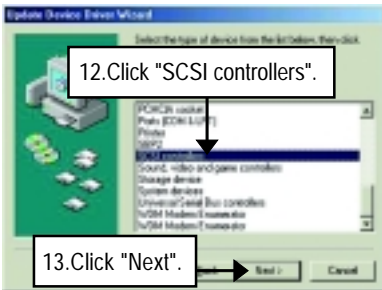

(9)

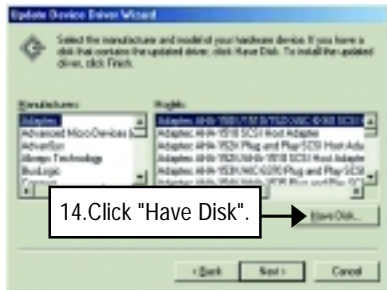

(10)

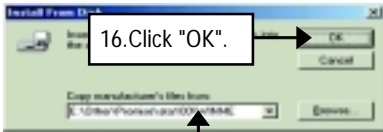

15. Type "D:\Other\Promise\ata100\WINME"  
(This manual assumes that your CD-ROM  
device drive letter is D:).

(11)

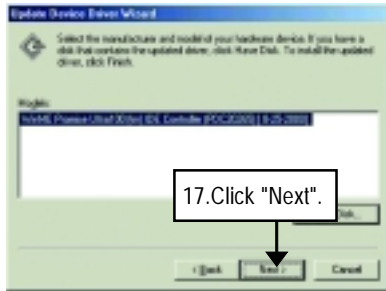

(12)

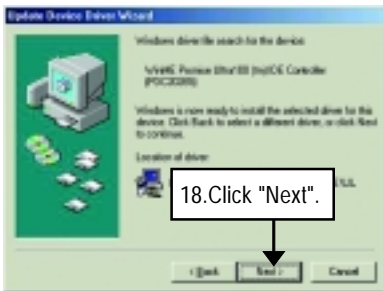

(13)

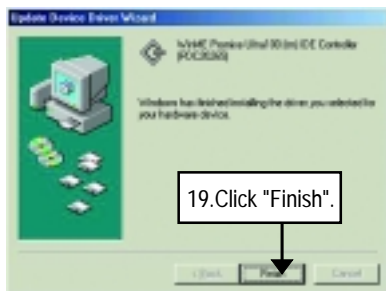

(14)

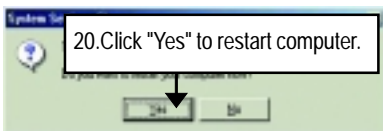

(15)

- If you want to realize the setup information in detail, please refer to the "Driver Information" for setting your system completely.

### B. Promise RAID Driver Installation:

Insert the driver CD-title that came with your motherboard into your CD-ROM driver, the driver CD-title will auto start and show the installation guide. If not, please double click the CD-ROM device icon in "My computer", and execute the setup.exe.

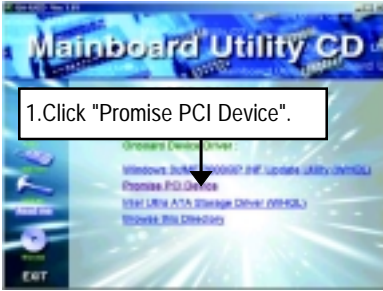

(1)

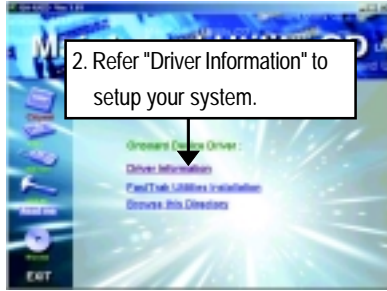

(2)

➤ For your reference, you can use the following steps to complete the Promise RAID Driver Installation.

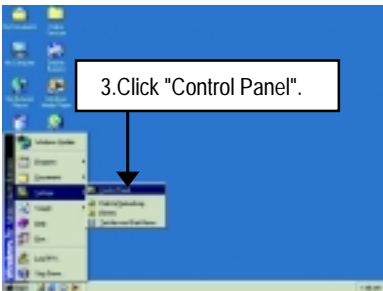

(3)

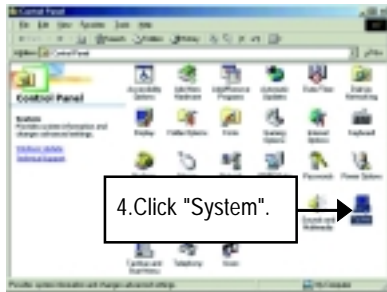

(4)



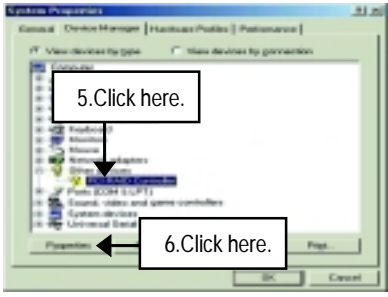

(5)

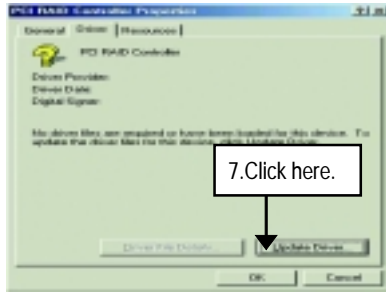

(6)

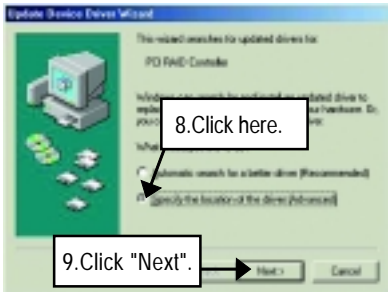

(7)

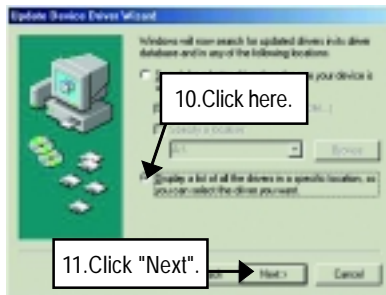

(8)

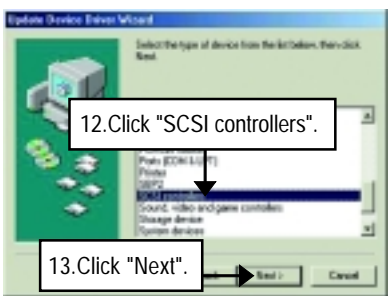

(9)

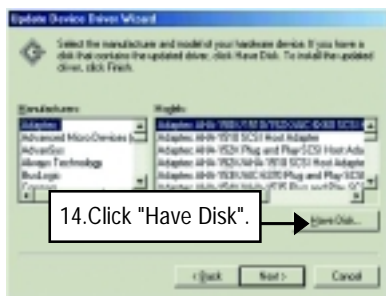

(10)

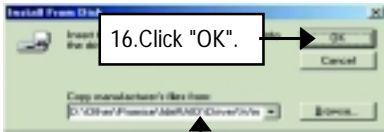

16. Click "OK".

15. Type "D:\Other\Promise\IdeRAID\Driver\win9x-ME"  
(This manual assumes that your CD-ROM device drive letter is D:).

(11)

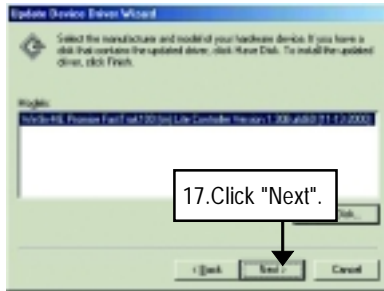

17. Click "Next".

(12)

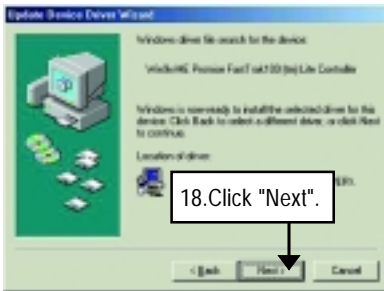

18. Click "Next".

(13)

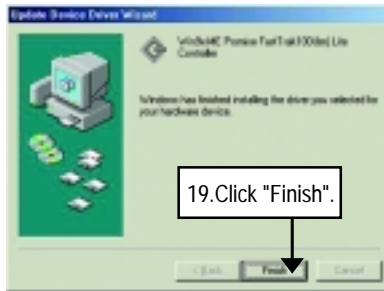

19. Click "Finish".

(14)

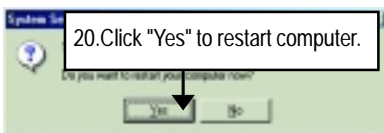

20. Click "Yes" to restart computer.

(15)

➤ If you want to realize the setup information in detail, please refer to the "Driver Information" for setting your system completely.

### C. FastTrak Utilities Installation:

Insert the driver CD-title that came with your motherboard into your CD-ROM driver, the driver CD-title will auto start and show the installation guide. If not, please double click the CD-ROM device icon in "My computer", and execute the setup.exe.



(1)



(2)



(3)

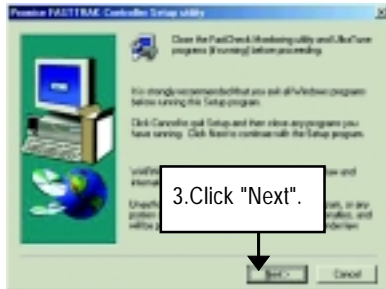

(4)

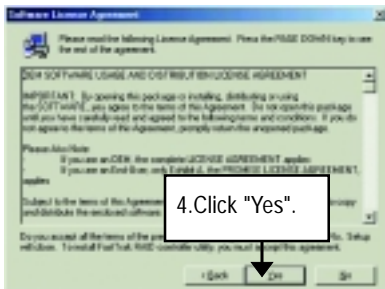

(5)

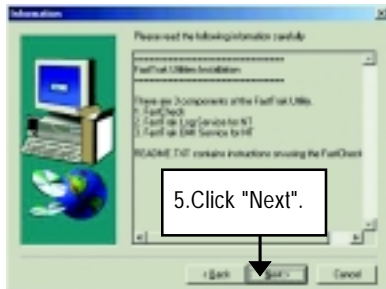

(6)

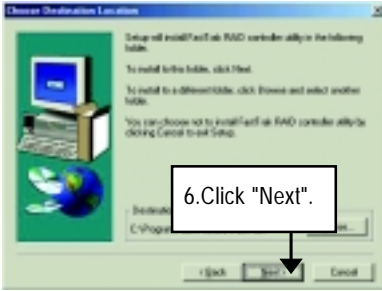

(7)

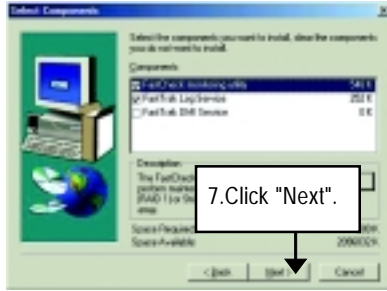

(8)

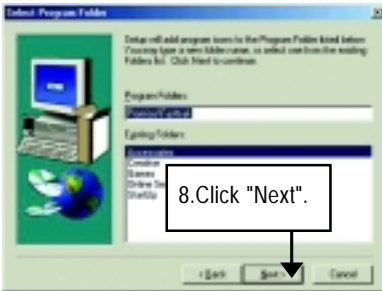

(9)

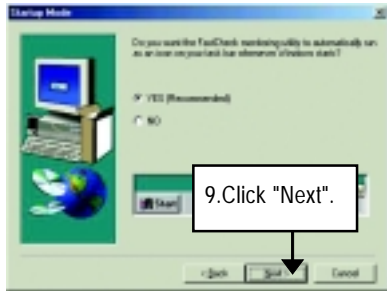

(10)

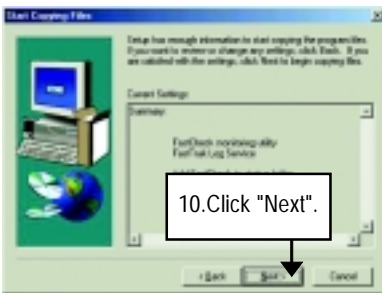

(11)

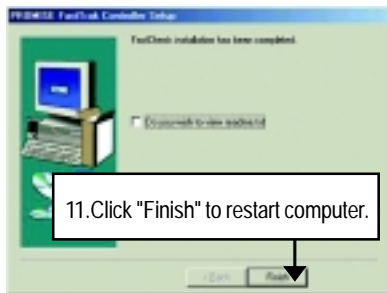

(12)

## Appendix F: Intel 850 Chipset Driver Installation (Part 2)

### Intel Ultra ATA Storage Driver:

Insert the driver CD-title that came with your motherboard into your CD-ROM driver, the driver CD-title will auto start and show the installation guide. If not, please double click the CD-ROM device icon in "My computer", and execute the setup.exe.



(1)



(2)

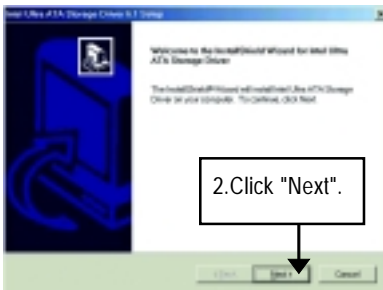

(3)

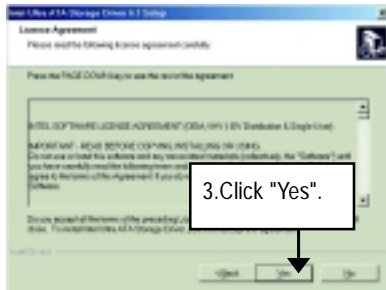

(4)

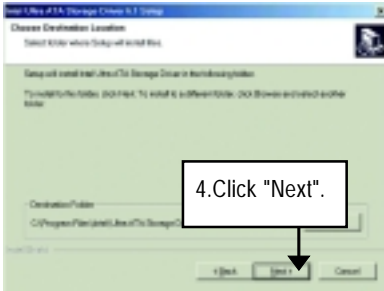

(5)

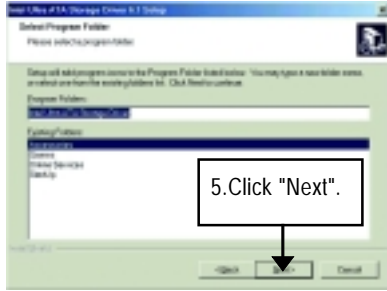

(6)

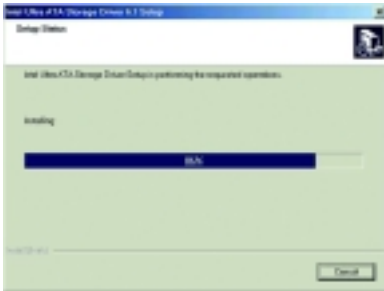

(7)

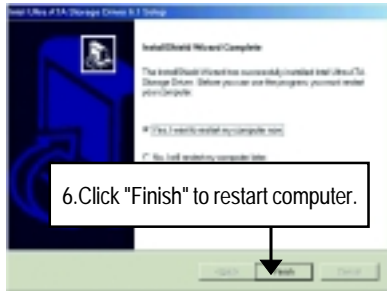

(8)

## Appendix G: EasyTuneIII Utilities Installation

Insert the driver CD-title that came with your motherboard into your CD-ROM driver, the driver CD-title will auto start and show the installation guide. If not, please double click the CD-ROM device icon in "My computer", and execute the setup.exe.

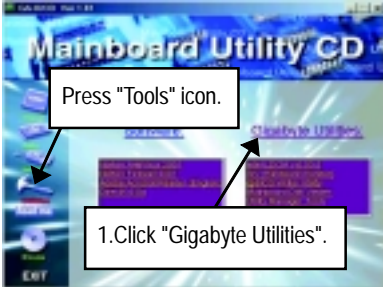

(1)



(2)

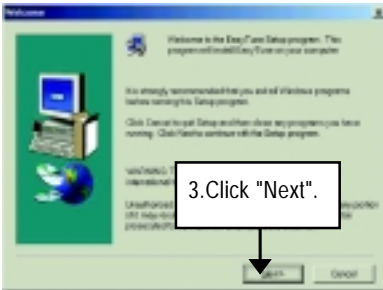

(3)

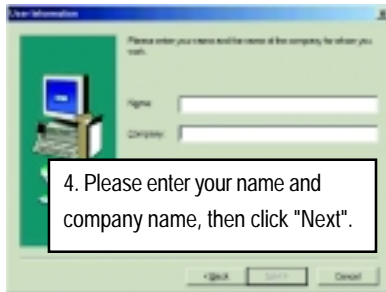

(4)

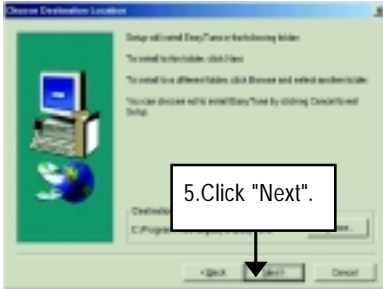

(5)

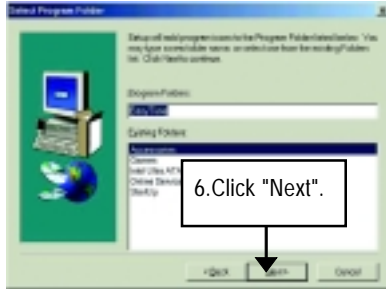

(6)

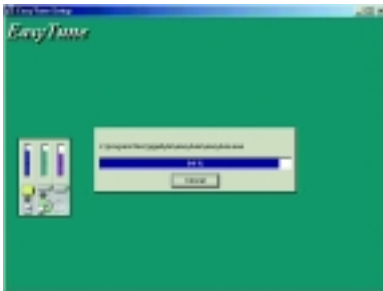

(7)

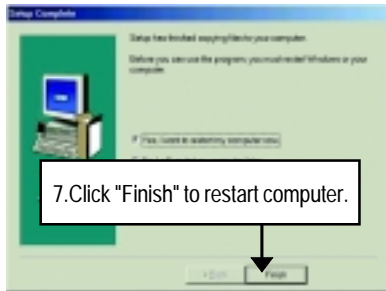

(8)



## Appendix H: Issues To Beware Of When Installing CNR

Please use standard CNR card like the one in order to avoid mechanical problem. (See Figure A)



Figure A: Standard CNR Card

## Appendix I: Acronyms

Acronyms	Meaning
ACPI	Advanced Configuration and Power Interface
APM	Advanced Power Management
AGP	Accelerated Graphics Port
AMR	Audio Modem Riser
ACR	Advanced Communications Riser
BIOS	Basic Input / Output System
CPU	Central Processing Unit
CMOS	Complementary Metal Oxide Semiconductor
CRIMM	Continuity RIMM
CNR	Communication and Networking Riser
DMA	Direct Memory Access
DMI	Desktop Management Interface
DIMM	Dual Inline Memory Module
DRM	Dual Retention Mechanism
DRAM	Dynamic Random Access Memory
DDR	Double Data Rate
ECP	Extended Capabilities Port
ESCD	Extended System Configuration Data
ECC	Error Checking and Correcting
EMC	Electromagnetic Compatibility
EPP	Enhanced Parallel Port
ESD	Electrostatic Discharge
FDD	Floppy Disk Device
FSB	Front Side Bus
HDD	Hard Disk Device
IDE	Integrated Dual Channel Enhanced
IRQ	Interrupt Request
I/O	Input / Output
IOAPIC	Input Output Advanced Programmable Input Controller
ISA	Industry Standard Architecture
LAN	Local Area Network

to be continued.....

---

Acronyms	Meaning
LBA	Logical Block Addressing
LED	Light Emitting Diode
MHz	Megahertz
MIDI	Musical Interface Digital Interface
MTH	Memory Translator Hub
MPT	Memory Protocol Translator
NIC	Network Interface Card
OS	Operating System
OEM	Original Equipment Manufacturer
PAC	PCI A.G.P. Controller
POST	Power-On Self Test
PCI	Peripheral Component Interconnect
RIMM	Rambus in-line Memory Module
SCI	Special Circumstance Instructions
SECC	Single Edge Contact Cartridge
SRAM	Static Random Access Memory
SMP	Symmetric Multi-Processing
SMI	System Management Interrupt
USB	Universal Serial Bus
VID	Voltage ID

---

**Technical Support/RMA Sheet**



Customer/Country:	Company:	Phone No.:
Contact Person:	E-mail Add. :	

Model name/Lot Number:	PCB revision:
BIOS version:	O.S./A.S.:

Hardware Configuration	Mfs.	Model name	Size:	Driver/Utility:
CPU				
Memory				
Brand				
Video Card				
Audio Card				
HDD				
CD-ROM / DVD-ROM				
Modem				
Network				
AMR / CNR				
Keyboard				
Mouse				
Power supply				
Other Device				

Problem Description:

\_\_\_\_\_

\_\_\_\_\_

