



- ✍ The author assumes no responsibility for any errors or omissions that may appear in this document nor does the author make a commitment to update the information contained herein.
- ✍ Third-party brands and names are the property of their respective owners.
- ✍ Please do not remove any labels on motherboard, this may void the warranty of this motherboard.
- ✍ Due to rapid change in technology, some of the specifications might be out of date before publication of this booklet.



Mise en garde : Ne faites jamais retirer le processeur sans que le dissipateur de chaleur soit fixé correctement et fermement car UN DOMMAGE PERMANENT EN RÉSULTE !

Achtung: Der Prozessor darf nur in Betrieb genommen werden, wenn der Wärmehaube ordnungsgemäß und fest angebracht ist. DIES HAT EINEN PERMANENTEN SCHADEN ZUR FOLGE!

Advertencia: Nunca desmonte el procesador sin el disipador de calor correctamente y firmemente. SE PRODUCIRÁ UN DAÑO PERMANENTE.

Atenção: Nunca execute o processador sem o dissipador de calor estar adequadamente e firmemente montado. O RESULTADO SERÁ UM DANO PERMANENTE.

警告：務必將散熱器正確安裝在CPU上，否則CPU將永久損壞！

警告：安裝散熱器時，務必將散熱器正確安裝在CPU上，否則CPU將永久損壞！

경고：CPU를 작동할 때는 반드시 열 방출 장치를 올바르게 설치하여야 합니다. 그렇지 않으면 영구적인 손상을 입을 수 있습니다.

警告：務必將散熱器正確安裝在CPU上，否則CPU將永久損壞！

Declaration of Conformity

We, Manufacturer/Importer
(full address)

G.B.T. Technology Trading GmbH
Ausschlagweg 41, 1F, 20537 Hamburg, Germany

declare that the product
(description of the apparatus, system, installation to which it refers)

Mother Board
GA-8 SIML

is in conformity with
(reference to the specification under which conformity is declared)
in accordance with 89/336 EEC-EMC Directive

EN 55011	Limits and methods of measurement of radio disturbance characteristics of industrial, scientific and medical (ISM) high frequency equipment	EN 61000-3-2* EN 61555-2	Disturbances in supply systems cause by household appliances and similar electrical equipment " Harmonics"
EN 55013	Limits and methods of measurement of radio disturbance characteristics of broadcast receivers and associated equipment	EN 61000-3-3* EN 61555-3	Disturbances in supply systems cause by household appliances and similar electrical equipment " Voltage fluctuations"
EN 55014	Limits and methods of measurement of radio disturbance characteristics of household electrical appliances, portable tools and similar electrical apparatus	EN 5081-1 EN 5082-1	Generic emission standard Part 1: Residual commercial and light industry Generic immunity standard Part 1: Residual commercial and light industry
EN 55015	Limits and methods of measurement of radio disturbance characteristics of fluorescent lamps and luminaries	EN 5081-2	Generic emission standard Part 2: Industrial environment
EN 55020	Immunity from radio interference of broadcast receivers and associated equipment	EN 5082-2	Generic emission standard Part 2: Industrial environment
EN 55022	Limits and methods of measurement of radio disturbance characteristics of information technology equipment	ENV 55104	Immunity requirements for household appliances tools and similar apparatus
DIN VDE 0855 part 10 part 12	Cabled distribution systems: Equipment for receiving and/or distribution from sound and television signals	EN 50091-2	EMC requirements for uninterruptible powersystems (UPS)
CE marking			(EC conformity marking)

The manufacturer also declares the conformity of above mentioned product with the actual required safety standards in accordance with LVD 73/23/EEC

EN 60065	Safety requirements for mains operated electronic and related apparatus for household and similar general use	EN 60950
EN 60335	Safety of household and similar electrical appliances	EN 50091-1

Manufacturer/Importer

(S la mp)

Date: Dec 18, 2001

Signature: Timmy Huang
Name: Timmy Huang

DECLARATION OF CONFORMITY

Per FCC Part 2 Section 2.1077(a)



Responsible Party Name: G.B.T. INC. (U.S.A.)

Address: 17358 Railroad Street

City of Industry, CA 91748

Phone/Fax No: (818) 854-9338 / (818) 854-9339

hereby declares that the product

Product Name: Motherboard

Model Number: GA-8S1ML

Conforms to the following specifications:

FCC Part 15, Subpart B, Section 15.107(a) and Section 15.109
(a), Class B Digital Device

Supplementary Information:

This device complies with part 15 of the FCC Rules. Operation is subject to the following two conditions: (1) This device may not cause harmful and (2) this device must accept any interference received, including that may cause undesired operation.

Representative Person's Name: ERIC LU

Signature: Eric Lu

Date: Dec. 18, 2001

GA-8SIML
P4 Titan-DDR Motherboard

USER'S MANUAL

Pentium®4 Processor Motherboard
Rev. 1.1 First Edition
12ME-8SIML-1101

Table of Content

Revision History	4
Item Checklist	4
WARNING!	5
Chapter 1 Introduction	6
Features Summary.....	6
GA-8SIML Motherboard Layout	8
Chapter 2 Hardware Installation Process	9
Step 1: Install the Central Processing Unit (CPU)	10
CPU Installation	10
CPU Heat Sink Installation	11
Step 2: Install memory modules	12
Step 3: Install expansion cards	13
Step 4: Connect ribbon cables, cabinet wires, and power supply	14
I/O Back Panel Introduction	14
Connectors Introduction	16
Chapter 3 BIOS Setup	22
The Main Menu (For example: BIOS Ver. :FA)	23
Standard CMOS Features	25
Advanced BIOS Features	28
Advanced Chipset Features	31
Integrated Peripherals	33

Power Management Setup	38
PnP/PCI Configurations	41
PC Health Status	43
Frequency/Voltage Control	45
Load Fail-Safe Defaults	47
Load Optimized Defaults	48
Set Supervisor/User Password	49
Save & Exit Setup	50
Exit Without Saving	51
Chapter 4 Technical Reference	52
Block Diagram	52
@ BIOS Introduction	53
Chapter 5 Appendix	54

Revision History

Revision	Revision Note	Date
1.1	Initial release of the GA-8SIML motherboard user's manual.	Jan. 2002

Item Checklist

- ✍ The GA-8SIML motherboard
- ✍ IDE cable x 1/ Floppy cable x 1
- ✍ CD for motherboard driver & utility (TUCD)
- ✍ GA-8SIML user's manual
- ✍ Internal COM B Cable (Optional)

WARNING!



Computer motherboards and expansion cards contain very delicate Integrated Circuit (IC) chips. To protect them against damage from static electricity, you should follow some precautions whenever you work on your computer.

1. Unplug your computer when working on the inside.
2. Use a grounded wrist strap before handling computer components. If you do not have one, touch both of your hands to a safely grounded object or to a metal object, such as the power supply case.
3. Hold components by the edges and try not touch the IC chips, leads or connectors, or other components.
4. Place components on a grounded antistatic pad or on the bag that came with the components whenever the components are separated from the system.
5. Ensure that the ATX power supply is switched off before you plug in or remove the ATX power connector on the motherboard.

Installing the motherboard to the chassis...

If the motherboard has mounting holes, but they don't line up with the holes on the base and there are no slots to attach the spacers, do not become alarmed you can still attach the spacers to the mounting holes. Just cut the bottom portion of the spacers (the spacer may be a little hard to cut off, so be careful of your hands). In this way you can still attach the motherboard to the base without worrying about short circuits. Sometimes you may need to use the plastic springs to isolate the screw from the motherboard PCB surface, because the circuit wire may be near by the hole. Be careful, don't let the screw contact any printed circuit write or parts on the PCB that are near the fixing hole, otherwise it may damage the board or cause board malfunctioning.

Chapter 1 Introduction

Features Summary

Form Factor	☞ 22.9cm x 24.3cm Micro ATX size form factor, 4 layers PCB.
CPU	☞ Socket 478 for Intel® Micro FC-PGA2 Pentium® 4 processor ☞ Support Intel® Pentium® 4 (Northwood, 0.13um) processor ☞ Intel Pentium®4 400MHz FSB ☞ 2nd cache depends on CPU
Chipset	☞ SiS 650 Host/Memory controller ☞ SiS 961 MuTIOL Media I/O
Memory	☞ 2 184-pin DDR DIMM sockets ☞ Supports DDR333/DDR266/200 SDRAM ☞ Supports Up to 2 un-buffer DIMM DDR333 or up to 2 un-buffer Double-sided DIMM DDR266/200 ☞ Supports up to 2GB DDR DRAM (Max) ☞ Supports only 2.5V DDR DIMM ☞ Supports 64bit DRAM integrity mode
I/O Control	☞ W83697HF
Slots	☞ 1 Universal AGP slot (1X/2X/4X) device support ☞ 3 PCI slot supports 33MHz & PCI 2.2 compliant ☞ 1 CNR(Communication and Networking Riser) Slot
On-Board IDE	☞ 2 IDE bus master (UDMA33/ATA66/ATA100) IDE ports for up to 4 ATAPI devices ☞ Supports PIO mode3,4 (UDMA 33/ATA66/ATA100) IDE & ATAPI CD-ROM
On-Board Peripherals	☞ 1 Floppy port supports 2 FDD with 360K, 720K, 1.2M, 1.44M and 2.88M bytes. ☞ 1 Parallel port supports Normal/EPP/ECP mode ☞ 1 Serial port (COMA), 1 VGA port, COMB on board ☞ 4 USB ports (Rear USB x 2, by optional cable) ☞ 1 Front Audio Connector*

*For PCB 1.1ver only

to be continued.....

	☞ 1 IrDA connector for IR
Hardware Monitor	☞ CPU/System Fan Revolution detect ☞ CPU/System Fan Control ☞ CPU Overheat Warning ☞ System Voltage Detect
On-Board Sound	☞ Realtek ALC201A CODEC ☞ Line In/Line Out/Mic In/CD In/ SPDIF/Game Port
On-Board LAN	☞ Built in RTL8100L Chipset ☞ 1 RJ45 port
On-Board VGA	☞ Built in SiS650 Chipset
PS/2 Connector	☞ PS/2 Keyboard interface and PS/2 Mouse interface
BIOS	☞ Licensed Award BIOS, 2M bit Flash ROM
Additional Features	☞ PS/2 Keyboard power on by password ☞ PS/2 Mouse power on ☞ STR(Suspend-To-RAM) ☞ AC Recovery ☞ USB KB/Mouse wake up from S3 ☞ Supports @BIOS



Please set the CPU host frequency in accordance with your processor's specifications. We don't recommend you to set the system bus frequency over the CPU's specification because these specific bus frequencies are not the standard specifications for CPU, chipset and most of the peripherals. Whether your system can run under these specific bus frequencies properly will depend on your hardware configurations, including CPU, Chipsets, SDRAM, Cards....etc.

GA-8SIML Motherboard Layout

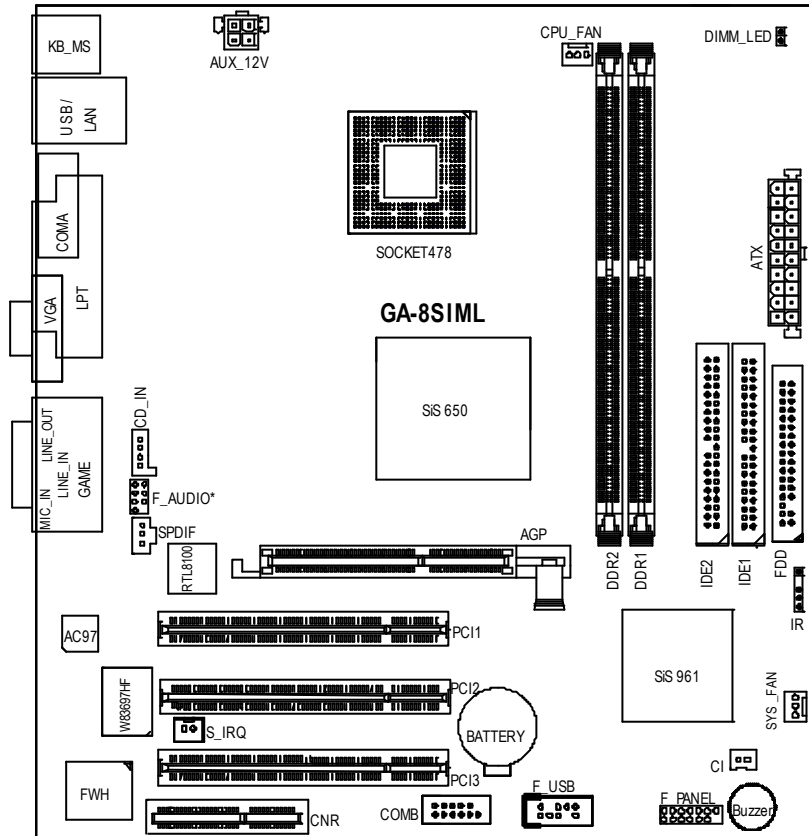

*For PCB 1.1ver only

Chapter 2 Hardware Installation Process

To setup your computer, you must complete the following steps:

- Step 1- Install the Central Processing Unit (CPU)
- Step 2- Install memory modules
- Step 3- Install expansion cards
- Step 4- Connect ribbon cables, cabinet wires, and power supply
- Step 5- Setup BIOS software
- Step 6- Install supporting software tools

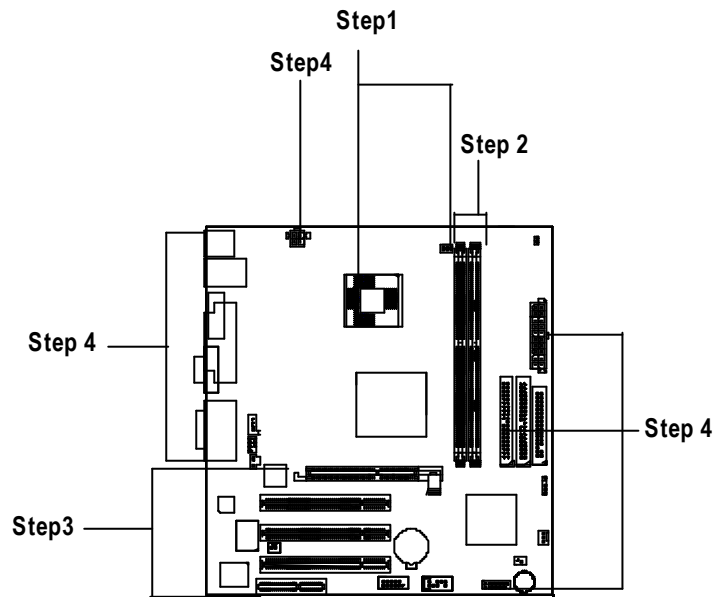

Step 1: Install the Central Processing Unit (CPU)

CPU Installation



CPU Top View

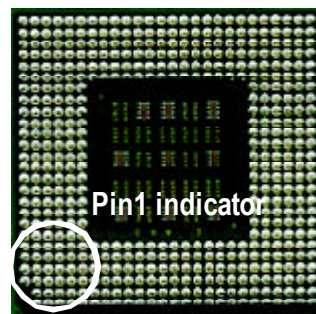

CPU Bottom View

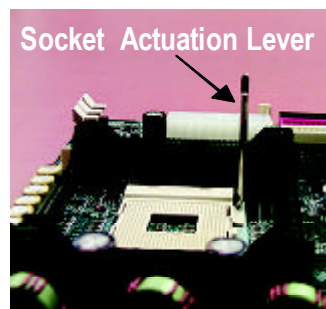

1. Pull up the CPU socket lever and up to 90-degree angle.
3. Press down the CPU socket lever and finish CPU installation.



2. Locate Pin 1 in the socket and look for a (golden) cut edge on the CPU upper corner. Then insert the CPU into the socket.

- ⚠ Please make sure the CPU type is supported by the motherboard.
- ⚠ If you do not match the CPU socket Pin 1 and CPU cut edge well, it will cause improper installation. Please change the insert orientation.

CPU Heat Sink Installation



1. Hook one end of the cooler bracket to the CPU socket first.

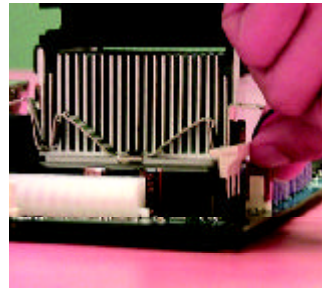

2. Hook the other end of the cooler bracket to the CPU socket.

- ✍ **Please use Intel approved cooling fan.**
- ✍ **We recommend you to apply the thermal tape to provide better heat conduction between your CPU and heatsink.**
(The CPU cooling fan might stick to the CPU due to the hardening of the thermal paste. During this condition if you try to remove the cooling fan, you might pull the processor out of the CPU socket along with the cooling fan, and might damage the processor. To avoid this from happening, we suggest you to either use thermal tape instead of thermal paste, or remove the cooling fan with extreme caution.)
- ✍ **Make sure the CPU fan power cable is plugged in to the CPU fan connector, this completes the installation.**
- ✍ **Please refer to CPU heat sink user's manual for more detail installation procedure.**

Step 2: Install memory modules

The motherboard has 2 dual inline memory module (DIMM) sockets. The BIOS will automatically detects memory type and size. To install the memory module, just push it vertically into the DIMM Slot. The DIMM module can only fit in one direction due to the notch. Memory size can vary between sockets.

Total Memory Sizes With Unbuffered DDR DIMM

Devices used on DIMM	1 DIMM x 64 / x 72	2 DIMMs x 64 / x 72
64 Mbit (2Mx 8x4 banks)	128 MBytes	256 MBytes
64 Mbit (1Mx 16x4 banks)	32 MBytes	64 MBytes
128 Mbit(4Mx 8x4 banks)	256 MBytes	512 MBytes
128 Mbit(2Mx 16x4 banks)	64 MBytes	128 MBytes
256 Mbit(8Mx 8x4 banks)	512 MBytes	1 GBytes
256 Mbit(4Mx 16x4 banks)	128 MBytes	256 MBytes
512 Mbit(16Mx 8x4 banks)	1 GBytes	2 GBytes
512 Mbit(8Mx 16x4 banks)	256 MBytes	512 MBytes

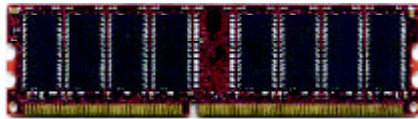

DDR

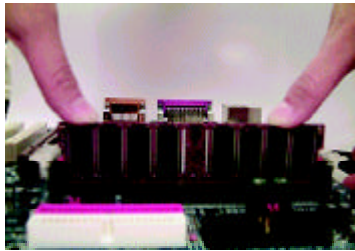

1. The DIMM slot has a notch, so the DIMM memory module can only fit in one direction.
2. Insert the DIMM memory module vertically into the DIMM slot. Then push it down.
3. Close the plastic clip at both edges of the DIMM slots to lock the DIMM module.

Reverse the installation steps when you wish to remove the DIMM module.

Please note that the DIMM module can only fit in one direction due to the one notches. Wrong orientation will cause improper installation. Please change the insert orientation.

DDR Introduction

Established on the existing SDRAM industry infrastructure, DDR (Double Data Rate) memory is a high performance and cost-effective solution that allows easy adoption for memory vendors, OEMs and system integrators.

DDR memory is a sensible evolutionary solution for the PC industry that builds on the existing SDRAM infrastructure, yet makes awesome advances in solving the system performance bottleneck by doubling the memory bandwidth. DDR SDRAM will offer a superior solution and migration path from existing SDRAM designs due to its availability, pricing and overall market support. PC2100 DDR memory (DDR266) doubles the data rate through reading and writing at both the rising and falling edge of the clock, achieving data bandwidth 2X greater than PC133 when running with the same DRAM clock frequency. With peak bandwidth of 2.1GB per second, DDR memory enables system OEMs to build high performance and low latency DRAM subsystems that are suitable for servers, workstations, high-end PC's and value desktop SMA systems. With a core voltage of only 2.5 Volts compared to conventional SDRAM's 3.3 volts, DDR memory is a compelling solution for small form factor desktops and notebook applications.

Step 3: Install expansion cards

1. Read the related expansion card's instruction document before install the expansion card into the computer.
2. Remove your computer's chassis cover, necessary screws and slot bracket from the computer.
3. Press the expansion card firmly into expansion slot in motherboard.
4. Be sure the metal contacts on the card are indeed seated in the slot.
5. Replace the screw to secure the slot bracket of the expansion card.
6. Replace your computer's chassis cover.
7. Power on the computer, if necessary, setup BIOS utility of expansion card from BIOS.
8. Install related driver from the operating system.

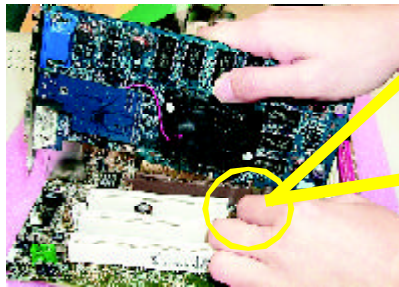

AGP Card

Please carefully pull out the small white-drawable bar at the end of the AGP slot when you try to install/ Uninstall the AGP card. Please align the AGP card to the onboard AGP slot and press firmly down on the slot. Make sure your AGP card is locked by the small white-drawable bar.

Step 4: Connect ribbon cables, cabinet wires, and power supply

Step4-1:I/O Back Panel Introduction

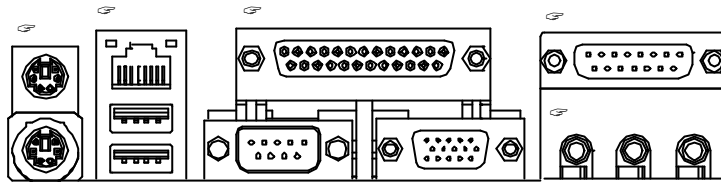

☞ PS/2 Keyboard and PS/2 Mouse Connector



PS/2 Mouse Connector
(6 pin Female)

PS/2 Keyboard Connector
(6 pin Female)

☞ This connector supports standard PS/2 keyboard and PS/2 mouse.

☞ USB & LAN Connector

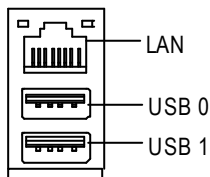

LAN

USB 0

USB 1

☞ Before you connect your device(s) into USB connector(s), please make sure your device(s) such as USB keyboard, mouse, scanner, zip, speaker...etc. Have a standard USB interface. Also make sure your OS (Win 95 with USB supplement, Win98, Windows 2000, Windows ME, Win NT with SP 6) supports USB controller. If your OS does not support USB controller, please contact OS vendor for possible patch or driver upgrade. For more information please contact your OS or device(s) vendors.

☞ **Parallel Port , Serial Port and VGA Port (LPT/COMA/VGA)**

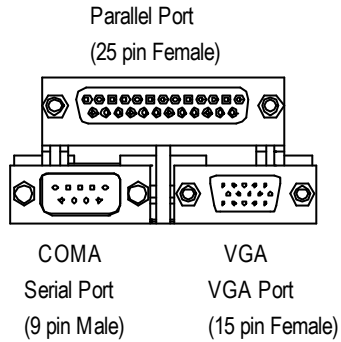

☞ This connector supports 1 standard COM port , 1 Parallel port and 1 VGA port. Device like printer can be connected to Parallel port ; mouse and modem etc can be connected to Serial ports.

☞ **Game /MIDI Ports**

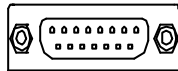

Joy stick/ MIDI (15 pin Female)

☞ This connector supports joystick, MIDI keyboard and other relate audio devices.

☞ **Audio Connectors**

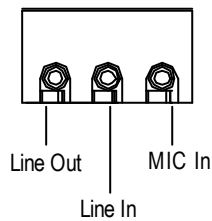

☞ After install onboard audio driver, you may connect speaker to Line Out jack, micro phone to MIC Injack. Device like CD-ROM , walkman etc can be connected to Line-In jack.

A) AUX_12V

B) CPU_FAN

GA-8SIML Motherboard

C) ATX
Connectors Introduction

D) IDE1/IDE2

E) FLOPPY

F) IR

G) SYS_FAN

H) CI

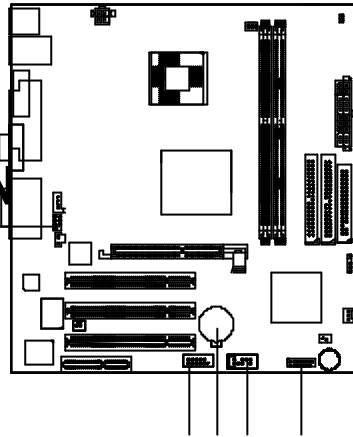

I) F_PANEL

J) F_USB

K) BAT

L) COMB

M) S_IRQ

N) SPDIF

O) F_AUDIO *

P) CD_IN

*For PCB 1.1ver only

A) AUX_12V (+12V Power Connector)

⚡ This connector (ATX +12V) supplies the CPU operation voltage (V_{core}).
If this " ATX+ 12V connector" is not connected, system cannot boot.

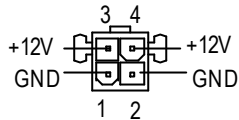

B) CPU_FAN (CPU FAN Connector)

⚡ Please note, a proper installation of the CPU cooler is essential to prevent the CPU from running under abnormal condition or damaged by overheating. The CPU fan connector supports Max. current up to 600 mA.



J) SYS_FAN (System FAN Connector)

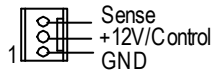

H) CI (CASE OPEN)

⚡ This 2 pin connector allows your system to enable or disable the system alarm if the system case begins to be removed.

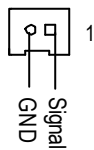

E) FDD (Floppy Connector)

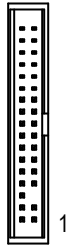

D) IDE1/ IDE2 (IDE1/IDE2 Connector)

⚠ Important Notice:

Please connect first harddisk to IDE1
and connect CDROM to IDE2.

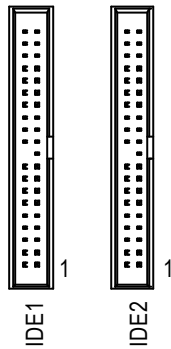

O) F_AUDIO (Front Audio Connector)*

⚠ If you want to use "Front Audio" connector, you must move 3-4,5-6 Jumper. In order to utilize the front audio header, your chassis must have front audio connector. Also please make sure the pin assignment on the cable is the same as the pin assignment on the MB header. To find out if the chassis you are buying support front audio connector, please contact your dealer.

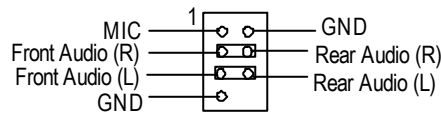

*For PCB 1.1ver only

P) CD_IN (CD Audio Line In)

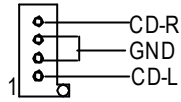

N) SPDIF



✍ The SPDIF output is capable of providing digital audio to external speakers or compressed AC3 data to an external Dolby Digital Decoder. Use this feature only when your stereo system has digital output function.

L) COM B

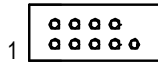

M) S_IRQ

(For special design, for example: PCMCIA add on card)

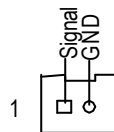

C) ATX (ATX Power)

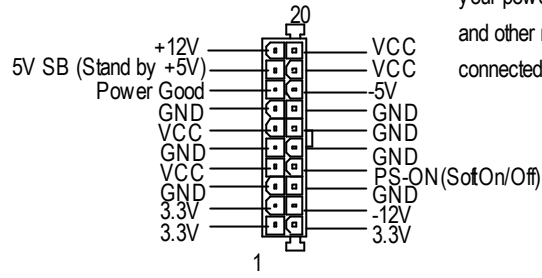

⚠ AC power cord should only be connected to your power supply unit after ATX power cable and other related devices are firmly connected to the mainboard.

J) F_USB (Front USB Connector)

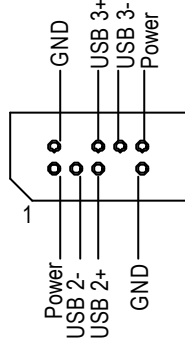

⚠ Be careful with the polarity of the front panel USB connector. Check the pin assignment while you connect the front panel USB cable. Please contact your nearest dealer for optional front panel USB cable.

F) IR

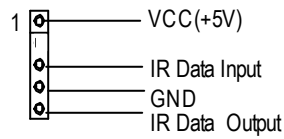

⚠ Be careful with the polarity of the IR connector while you connect the IR. Please contact your nearest dealer for optional IR device.

I) F_PANEL (2x7 pins jumper)

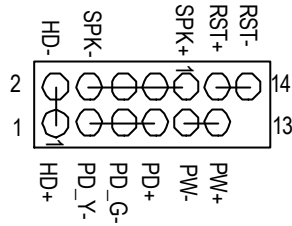

HD (IDE Hard Disk Active LED)	Pin 1: LED anode(+) Pin 2: LED cathode(-)
SPK (Speaker Connector)	Pin 1: VCC(+) Pin 2- Pin 3: NC Pin 4: Data(-)
RST (Reset Switch)	Open: Normal Operation Close: Reset Hardware System
PD+/PD_G-/PD_Y-(Power LED)	Pin 1: LED anode(+) Pin 2: LED cathode(-) Pin 3: LED cathode(-)
PW (Soft Power Connector)	Open: Normal Operation Close: Power On/Off

⚠ Please connect the power LED, PC speaker, reset switch and power switch etc of your chassis front panel to the F_PANEL connector according to the pin assignment above.

K) Battery

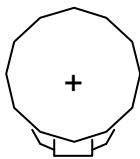

CAUTION

- ⚠ Danger of explosion if battery is incorrectly replaced.
- ⚠ Replace only with the same or equivalent type recommended by the manufacturer.
- ⚠ Dispose of used batteries according to the manufacturer's instructions.

Chapter 3 BIOS Setup

BIOS Setup is an overview of the BIOS Setup Program. The program that allows users to modify the basic system configuration. This type of information is stored in battery-backed CMOS RAM so that it retains the Setup information when the power is turned off.

ENTERING SETUP

Power ON the computer and press immediately will allow you to enter Setup.

CONTROL KEYS

<Left>	Move to previous item
<Right>	Move to next item
<Left>	Move to the item in the left hand
<Right>	Move to the item in the right hand
<Esc>	Main Menu - Quit and not save changes into CMOS Status Page Setup Menu and Option Page Setup Menu - Exit current page and return to Main Menu
<+/PgUp>	Increase the numeric value or make changes
<-/PgDn>	Decrease the numeric value or make changes
<F1>	General help, only for Status Page Setup Menu and Option Page Setup Menu
<F2>	Reserved
<F3>	Reserved
<F4>	Reserved
<F5>	Restore the previous CMOS value from CMOS, only for Option Page Setup Menu
<F6>	Load the file-safe default CMOS value from BIOS default table
<F7>	Load the Optimized Defaults
<F8>	Dual BIOS/Q-Flash function
<F9>	Reserved
<F10>	Save all the CMOS changes, only for Main Menu

GETTING HELP

Main Menu

The on-line description of the highlighted setup function is displayed at the bottom of the screen.

Status Page Setup Menu / Option Page Setup Menu

Press F1 to pop up a small help window that describes the appropriate keys to use and the possible selections for the highlighted item. To exit the Help Window press <Esc>.

The Main Menu (For example: BIOS Ver. :FA)

If you want detail data setting before "BIOS ver FA", please download the manual from Gigabyte web <http://www.gigabyte.com.tw>.

Once you enter Award BIOS CMOS Setup Utility, the Main Menu (Figure 1) will appear on the screen. The Main Menu allows you to select from eight setup functions and two exit choices. Use arrow keys to select among the items and press <Enter> to accept or enter the sub-menu.

CMOS Setup Utility - Copyright (C) 1984-2002 Award Software

↵Standard CMOS Features	↵Frequency/Voltage Control
↵Advanced BIOS Features	Load Fail-Safe Defaults
↵Advanced Chipset Features	Load Optimized Defaults
↵Integrated Peripherals	Set Supervisor Password
↵Power Management Setup	Set User Password
↵PnP/PCI Configurations	Save & Exit Setup
↵PC Health Status	Exit Without Saving
ESC:Quit	↵↵↵↵:Select Item
F8: Q-Flash	F10:Save & Exit Setup
Time, Date, Hard Disk Type...	

Figure 1: Main Menu

☞ **Standard CMOS Features**

This setup page includes all the items in standard compatible BIOS.

☞ **Advanced BIOS Features**

This setup page includes all the items of Award special enhanced features.

☞ **Advanced Chipset Features**

This setup page includes all the items of chipset special features.

✍ **Integrated Peripherals**

This setup page includes all onboard peripherals.

✍ **Power Management Setup**

This setup page includes all the items of Green function features.

✍ **PnP/PCI Configurations**

This setup page includes all the configurations of PCI & PnP ISA resources.

✍ **PC Health Status**

This setup page is the System auto detect Temperature, voltage, fan, speed.

✍ **Frequency/Voltage Control**

This setup page is control CPU's clock and frequency ratio.

✍ **Load Fail-Safe Defaults**

Fail-Safe Defaults indicates the value of the system parameters which the system would be in safe configuration.

✍ **Load Optimized Defaults**

Optimized Defaults indicates the value of the system parameters which the system would be in best performance configuration.

✍ **Set Supervisor password**

Change, set, or disable password. It allows you to limit access to the system and Setup, or just to Setup.

✍ **Set User password**

Change, set, or disable password. It allows you to limit access to the system.

✍ **Save & Exit Setup**

Save CMOS value settings to CMOS and exit setup.

✍ **Exit Without Saving**

Abandon all CMOS value changes and exit setup.

Standard CMOS Features

CMOS Setup Utility-Copyright (C) 1984-2002 Award Software

Standard CMOS Features

Date (mm:dd:yy)	Fir, Jan 25 2002	Item Help
Time (hh:mm:ss)	22:31:24	Menu Level ↓
IDE Primary Master	[None]	Change the day, month, year and century
IDE Primary Slave	[None]	<Week>
IDE Secondary Master	[None]	Sun. to Sat.
IDE Secondary Slave	[None]	<Month>
Drive A	[1.44M, 3.5 in.]	Jan. to Dec.
Drive B	[None]	<Day>
Floppy 3 Mode Support	[Disabled]	1 to 31 (or maximum allowed in the month)
Halt On	[All, But Keyboard]	<Year>
Base Memory	640K	1999 to 2098
Extended Memory	130048K	
Total Memory	131072K	
↓↓↓↓: Move Enter:Select +/-/PU/PD:Value F10:Save ESC:Exit F1:General Help F5:Previous Values F6:Fail-Safe Defaults F7:Optimized Defaults		

Figure 2: Standard CMOS Features

☞ Date

The date format is <week>, <month>, <day>, <year>.

- ☞ Week The week, from Sun to Sat, determined by the BIOS and is display only
- ☞ Month The month, Jan. Through Dec.
- ☞ Day The day, from 1 to 31 (or the maximum allowed in the month)
- ☞ Year The year, from 1999 through 2098

☞ **Time**

The times format in <hour> <minute> <second>. The time is calculated base on the 24-hour military-time clock. For example, 1 p.m. is 13:00:00.

☞ **IDE Primary Master, Slave / IDE Secondary Master, Slave**

The category identifies the types of hard disk from drive C to F that has been installed in the computer. There are two types: auto type, and manual type. Manual type is user-definable; Auto type which will automatically detect HDD type.

Note that the specifications of your drive must match with the drive table. The hard disk will not work properly if you enter improper information for this category.

If you select User Type, related information will be asked to enter to the following items. Enter the information directly from the keyboard and press <Enter>. Such information should be provided in the documentation form your hard disk vendor or the system manufacturer.

- ☞ CYLS. Number of cylinders
- ☞ HEADS Number of heads
- ☞ PRECOMP Write precomp
- ☞ LANDZONE Landing zone
- ☞ SECTORS Number of sectors

If a hard disk has not been installed select NONE and press <Enter>.

☞ **Drive A / Drive B**

The category identifies the types of floppy disk drive A or drive B that has been installed in the computer.

- ☞ None No floppy drive installed
- ☞ 360K, 5.25 in. 5.25 inch PC-type standard drive; 360K byte capacity.
- ☞ 1.2M, 5.25 in. 5.25 inch AT-type high-density drive; 1.2M byte capacity
(3.5 inch when 3 Mode is Enabled).
- ☞ 720K, 3.5 in. 3.5 inch double-sided drive; 720K byte capacity
- ☞ 1.44M, 3.5 in. 3.5 inch double-sided drive; 1.44M byte capacity.
- ☞ 2.88M, 3.5 in. 3.5 inch double-sided drive; 2.88M byte capacity.

☞ Floppy 3 Mode Support (for Japan Area)

- | | |
|------------|---------------------------------------|
| ☞ Disabled | Normal Floppy Drive. (Default value) |
| ☞ Drive A | Drive A is 3 mode Floppy Drive. |
| ☞ Drive B | Drive B is 3 mode Floppy Drive. |
| ☞ Both | Drive A & B are 3 mode Floppy Drives. |

☞ Halt on

The category determines whether the computer will stop if an error is detected during power up.

- | | |
|---------------------|--|
| ☞ NO Errors | The system boot will not stop for any error that may be detected and you will be prompted. |
| ☞ All Errors | Whenever the BIOS detects a non-fatal error the system will be stopped. |
| ☞ All, But Keyboard | The system boot will not stop for a keyboard error; it will stop for all other errors. (Default value) |
| ☞ All, But Diskette | The system boot will not stop for a disk error; it will stop for all other errors. |
| ☞ All, But Disk/Key | The system boot will not stop for a keyboard or disk error; it will stop for all other errors. |

☞ Memory

The category is display-only which is determined by POST (Power On Self Test) of the BIOS.

Base Memory

The POST of the BIOS will determine the amount of base (or conventional) memory installed in the system.

The value of the base memory is typically 512 K for systems with 512 K memory installed on the motherboard, or 640 K for systems with 640 K or more memory installed on the motherboard.

Extended Memory

The BIOS determines how much extended memory is present during the POST.

This is the amount of memory located above 1 MB in the CPU's memory address map.

Advanced BIOS Features

CMOS Setup Utility - Copyright (C) 1984-2002 Award Software

Advanced BIOS Features

		Item Help
BIOS Flash Protection	[Auto]	
First Boot Device	[Floppy]	Menu Level ↵
Second Boot Device	[HDD-0]	[Auto]
Third Boot Device	[CDROM]	Allows BIOS to
Boot Up Floppy Seek	[Disabled]	update flash data
BootUp Num-Lock	[On]	during POST. It still
Password Check	[Setup]	prevents other
Interrupt Mode	[APIC]	unauthorized utilities
HDD S.M.A.R.T. Capability	[Disabled]	to update flash
		[Enabled]
		Always prevent BIOS
		and unauthorized
		utilities to update
		flash
↵↵↵↵↵: Move Enter:Select +/-/PU/PD:Value F10:Save ESC:Exit F1:General Help F5:Previous Values F6:Fail-Safe Defaults F7:Optimized Defaults		

Figure 3: Advanced BIOS Features

BIOS Flash Protection











This field lets you determine the states that flash BIOS

- Auto BIOS enables flash write access automatically when updating BIOS data/DMI/ESCD. (Default Value)
- Enabled During POST, DMI/ESCD would not be updated. But flash tools can update BIOS always.

First / Second / Third Boot Device



This feature allows you to select the boot device priority.

- Floppy Select your boot device priority by Floppy.

 LS120	Select your boot device priority by LS120.
 HDD-0~3	Select your boot device priority by HDD-0~3.
 SCSI	Select your boot device priority by SCSI.
 CDROM	Select your boot device priority by CDROM.
 ZIP	Select your boot device priority by ZIP.
 USB-FDD	Select your boot device priority by USB-FDD.
 USB-ZIP	Select your boot device priority by USB-ZIP.
 USB-CDROM	Select your boot device priority by USB-CDROM.
 USB-HDD	Select your boot device priority by USB-HDD.
 LAN	Select your boot device priority by LAN.
 Disabled	Select your boot device priority by Disabled.



Boot Up Floppy Seek

During POST, BIOS will determine the floppy disk drive installed is 40 or 80 tracks. 360 K type is 40 tracks 720 K, 1.2 M and 1.44 M are all 80 tracks.

 Enabled	BIOS searches for floppy disk drive to determine it is 40 or 80 tracks. Note that BIOS can not tell from 720 K, 1.2 M or 1.44 M drive type as they are all 80tracks.
 Disabled	BIOS will not search for the type of floppy disk drive by track number. Note that there will not be any warning message if the drive installed is 360 K. (Default value)

BootUp Num-Lock

When set On, allows the BIOS to automatically enable the Num Lock Function when the system boots up.

 On	Keypad is number keys. (Default value)
 Off	Keypad is arrow keys.

Password Check

This feature allows you to limit access to the system and Setup, or just to Setup.

Please refer to the detail on P.48

 System	The system can not boot and can not access to Setup page will be denied if the correct password is not entered at the prompt.
--	---

- Setup The system will boot, but access to Setup will be denied if the correct password is not entered at the prompt. (Default value)

Interrupt Mode

- APIC Through IOAPIC generate more IRQ for system use.(Default value)
- PIC Use AT standard IRQ controls to generate IRQ.

When you already have IOAPIC enable system and want to upgrade the system please note, since running an IOAPIC enabled OS (like Windows NT, Windows 2000, Windows XP...) system with none IOAPIC HW support will cause the system to hang. Following are some situations users might run into:
1. An IOAPIC enabled OS and change the BIOS setting from IOAPIC to PIC, this will cause your system to hang.)

HDD S.M.A.R.T Capability

S.M.A.R.T. stands for Self-Monitoring and Analysis Reporting Technology which allows your hard disk drive to report any read/write errors and issue a warning with LDCM installed.

- Enabled Enable HDD S.M.A.R.T. Capability.
- Disabled Disable HDD S.M.A.R.T. Capability. (Default value)

Advanced Chipset Features

We would not suggest you change the chipset default setting unless you really need it.

CMOS Setup Utility - Copyright (C) 1984-2002 Award Software

Advanced Chipset Features		Item Help
Top Performance	[Disabled]	Menu Level ↓
Configure DRAM Timing	[Auto]	
x CAS Latency Setting	Auto	
x DRAM RAS Active Time	6T	
x DRAM RAS Precharge Time	3T	
x DRAM RAS to CAS Delay	3T	
AGP Aperture Size	[64MB]	
↓ ↓ ↓ ↓ ↓ : Move Enter: Select +/-/PU/PD: Value F10: Save ESC: Exit F1: General Help F5: Previous Values F6: Fail-Safe Defaults F7: Optimized Defaults		

Figure 4: Advanced Chipset Features

☞ Top Performance

If you wish to maximize the performance of your system, set "Top Performance" as "Enabled".

- ☛ Disabled Disable this function. (Default Value)
- ☛ Enabled Enable Top Performance function.

☞ Configure DRAM Timing



Warning: Wrong DRAM Timing may make system can't boot. Clear CMOS to overcome wrong Timing issue)

- ☛ Auto Will be automatically detected by BIOS. (Default Value)
- ☛ Manual Set Configure DRAM Timing to Manual.





☞ CAS Latency Setting

This feature allows you to select the CAS latency Time, When any DDR DIMM installed.

- ☛ 2T Set CAS Latency Setting to 2T.
- ☛ 2.5T Set CAS Latency Setting to 2.5T.



-  3T Set CAS Latency Setting to 3T.
-  Auto Will be automatically detected by BIOS. (Default Value)

 **DRAMRAS Active Time**

-  4T Set DRAM RAS Active Time to 4T.
-  5T Set DRAM RAS Active Time to 5T.
-  6T Set DRAM RAS Active Time to 6T. (Default value)
-  7T Set DRAM RAS Active Time to 7T.



 **DRAMRAS Precharge Time**

This feature allows you to set the DRAM RAS# Precharge Time.

-  2T Set DRAM RAS Precharge Time to 2T.
-  3T Set DRAM RAS Precharge Time to 3T. (Default value)
-  4T Set DRAM RAS Precharge Time to 4T.



 **DRAMRAS to CAS Delay**

This feature allows you to set the delay time that from the DRAM RAS# active to CAS#.

-  2T Set DRAM RAS to CAS Delay to 2T.
-  3T Set DRAM RAS to CAS Delay to 3T. (Default value)
-  4T Set DRAM RAS to CAS Delay to 4T.

 **AGP Aperture Size**

(This feature allows you to select the main memory frame size for AGP use)

-  4MB AGP Aperture Size is 4MB.
-  8MB AGP Aperture Size is 8MB.
-  16MB AGP Aperture Size is 16MB.
-  32MB AGP Aperture Size is 32MB.
-  64MB AGP Aperture Size is 64MB. (Default value)
-  128MB AGP Aperture Size is 128MB.
-  256MB AGP Aperture Size is 256MB.

Integrated Peripherals

CMOS Setup Utility - Copyright (C) 1984-2002 Award Software

Integrated Peripherals

		Item Help
IDE1 Conductor Cable	[Auto]	
IDE2 Conductor Cable	[Auto]	Menu Level ↵
On-Chip Primary PCI IDE	[Enabled]	[Auto]
On-Chip Secondary PCI IDE	[Enabled]	Auto-detect IDE
AC97 Audio	[Enabled]	cable type
AC97 Modem	[Enabled]	
System share Memory Size	[32MB]	[ATA66/100]
USB Controller	[Enabled]	Set Conductor cable
USB Legacy Support	[Disabled]	to ATA66/100
Onboard LAN Function	[Enabled]	
Init Display First	[AGP]	[ATA33]
Onboard FDC	[Enabled]	Set Conductor cable
Onboard Serial Port A	[3F8/IRQ4]	to ATA33
Onboard Serial Port B	[2F8/IRQ3]	
Serial Port B Mode	[Normal]	
Onboard Parallel Port	[378/IRQ7]	
Parallel Port Mode	[ECP]	
☞EPP Mode Select	EPP1.7	
ECP Mode Use DMA	[3]	
Game Port Address	[201]	
Midi Port Address	[330]	
Midi Port IRQ	[10]	
↑↓←→: Move Enter:Select +/-/PU/PD:Value F10:Save ESC:Exit F1:General Help F5:Previous Values F6:Fail-Safe Defaults F7:Optimized Defaults		

Figure 5: Integrated Peripherals

☞ **IDE1 Conductor Cable**

- ☞ Auto Will be automatically detected by BIOS. (Default Value)
- ☞ ATA66/100 Set IDE1 Conductor Cable to ATA66/100 (Please make sure your IDE device and cable is compatible with ATA66/100).
- ☞ ATA33 Set IDE1 Conductor Cable to ATA33 (Please make sure your IDE device and cable is compatible with ATA33).

☞ **IDE2 Conductor Cable**

- ☞ Auto Will be automatically detected by BIOS. (Default Value)
- ☞ ATA66/100 Set IDE2 Conductor Cable to ATA66/100 (Please make sure your IDE device and cable is compatible with ATA66/100).
- ☞ ATA33 Set IDE2 Conductor Cable to ATA33 (Please make sure your IDE device and cable is compatible with ATA33).

☞ **On-Chip Primary PCI IDE**

When enabled, allows you to use the onboard primary PCI IDE.

- ☞ Enabled Enable onboard 1st channel IDE port. (Default value)
- ☞ Disabled Disable onboard 1st channel IDE port.

☞ **On-Chip Secondary PCI IDE**

When enabled, allows you to use the onboard secondary PCI IDE.

- ☞ Enabled Enable onboard 2nd channel IDE port. (Default value)
- ☞ Disabled Disable onboard 2nd channel IDE port.

☞ **AC97 Audio**

- ☞ Enabled Enable onboard AC'97 audio function. (Default Value)
- ☞ Disabled Disable this function.

☞ **AC97 Modem**

- ☞ Enabled BIOS will search MC97 Codec (AMR Modem Card). If found, MC97 function will be enabled. If no MC97 Codec found, MC97 function will be disabled.

(Default Value)

 Disabled Disable this function.

 **Share Memory Size**

 4MB/8MB/16MB/32MB/64MB Set onchip VGA shared memory size.(Default Value:32MB)

 **USB Controller**

Disable this option if you are not using the onboard USB feature.

 Enabled Enable USB Controller. (Default value)

 Disabled Disable USB Controller.

 **USB Legacy Support**

 Enabled Enable USB Legacy Support.

 Disabled Disable this function.(Default Value)

 **Onboard Lan**

 Disabled Disable this function.

 Enabled Enable Onboard Lan Chip function. (Default Value)

 **Init Display First**

This feature allows you to select the first initiation of the monitor display from which card, when you install an AGP VGA card and a PCI VGA card on board.

 PCI Set Init Display First to PCI Slot.

 AGP Set Init Display First to AGP. (Default value)

 **OnBoard FDC**

When enabled, the floppy diskette drive (FDD) controller is activated.





 Disabled Disable this function.

 Enabled Enable on board floppy disk controller.(Default value)







 **Onboard Serial Port A**

 Auto BIOS will automatically setup the port A address.

 3F8/IRQ4 Enable onboard Serial port A and using address 3F8 , IRQ4. (Default Value)



-  2F8/IRQ3 Enable onboard Serial port A and using daddress 2F8 , IRQ3.
-  3E8/IRQ4 Enable onboard Serial port A and using daddress 3E8 , IRQ4.
-  2E8/IRQ3 Enable onboard Serial port A and using daddress 2E8 , IRQ3.
-  Disabled Disable onboard Serial port A.

 **Onboard Serial Port B**

-  Auto BIOS will automatically setup the port B address.
-  3F8/IRQ4 Enable onboard Serial port B and using daddress 3F8 , IRQ4.
-  2F8/IRQ3 Enable onboard Serial port B and using daddress 2F8 , IRQ3. (Default Value)
-  3E8/IRQ4 Enable onboard Serial port B and using daddress 3E8 , IRQ4.
-  2E8/IRQ3 Enable onboard Serial port B and using daddress 2E8 , IRQ3.
-  Disabled Disable onboard Serial port B.





 **Serial Port B Mode**

(This item allows you to select the IR modes if the serial port B is used as an IR port. Set at Normal , if you use COM2 as the serial port as the serial port, instead as an IR port.)

-  ASKIR Set onboard I/O chip UART to ASKIR Mode.
-  IrDA Set onboard I/O chip UART to IrDa Mode.
-  Normal Set onboard I/O chip UART to Normal Mode. (Default Value)





 **OnBoard Parallel port**

This feature allows you to select from a given set of parameters if the parallel port uses the onboard I/O controller.

-  378/IRQ7 Enable On Board LPT port and using address 378, IRQ7.(Default Value)
-  278/IRQ5 Enable On Board LPT port and using address 278, IRQ5.
-  3BC/IRQ7 Enable On Board LPT port and using address 3BC, IRQ7.
-  Disabled Disable onboard Parallel port.

 **Parallel Port Mode**

This feature allows you to connect with an advanced print via the port mode it supports.

-  SPP Using Parallel port as Standard Parallel Port.
-  EPP Using Parallel port as Enhanced Parallel Port.
-  ECP Using Parallel port as Extended Capabilities Port.(Default Value)
-  ECP+EPP Using Parallel port as ECP & EPP mode.

☞ EPP Version

This feature allows you to select the EPP type version.

- ☞ EPP 1.9 Compliant with EPP 1.9 version.
- ☞ EPP 1.7 Compliant with EPP 1.7 version.(Default Value)

☞ Parallel Port DMA

This feature allows you to select Direct Memory Access(DMA) channel if the ECP mode selected.

- ☞ 3 Set Parallel Port DMA to 3.(Default Value)
- ☞ 1 Set Parallel Port DMA to 1.

☞ OnBoard Game Port

This feature allows you to select the game port address or disable it.

- ☞ Disabled Disable OnBoard Game Port.
- ☞ 201h Set OnBoard Game Port to 201h. (Default Value)
- ☞ 209h Set OnBoard Game Port to 209h.

☞ OnBoard Midi Port

This feature allows you to select the Midi port address or disable it.

- ☞ Disabled Disable onboard Midi Port.
- ☞ 300h Set onboard Midi Port to 300h.
- ☞ 330h Set onboard Midi Port to 330h. (Default Value)
- ☞ 290h Set onboard Midi Port to 290h.

☞ Midi IRQ Select

This feature allows you to select Midi IRQ is enabled.

- ☞ IRQ 5 / 10 (Default Value:10)

Power Management Setup

CMOS Setup Utility - Copyright (C) 1984-2002 Award Software

Power Management Setup

ACPI Suspend Type	[S1(POS)]	Item Help
MODEM Use IRQ	[AUTO]	Menu Level ↓
Soft-Off by Power Button	[Off]	
System After AC Back	[Off]	
IRQ [3-7, 9-15], NMI	[Enabled]	
ModemRingOn/WakeOnLan	[Enabled]	
PME Event Wake Up	[Enabled]	
USB Device Wake-up From S3	[Disabled]	
Power On by Mouse	[Disabled]	
KB Power ON Password	[Enter]	
Resume by Alarm	[Disabled]	
x Month Alarm	NA	
x Day of Month Alarm	0	
x Time (hh:nn:ss) Alarm	0 0 0	
↓ ↓ ↓ ↓ ↓ ↓ : Move Enter:Select +/-/PU/PD:Value F10:Save ESC:Exit F1:General Help F5:Previous Values F6:Fail-Safe Defaults F7:Optimized Defaults		

Figure 6: Power Management Setup

ACPI Suspend Type

- ☛ S1(POS) Set ACPI suspend type to S1. (Default Value)
- ☛ S3(STR) Set ACPI suspend type to S3.

MODEM Use IRQ

- ☛ AUTO Set MODEM Use IRQ to Auto. (Default value)
- ☛ 3 Set MODEM Use IRQ to 3.
- ☛ 4 Set MODEM Use IRQ to 4.
- ☛ 5 Set MODEM Use IRQ to 5.
- ☛ 7 Set MODEM Use IRQ to 7.

-
- 9 Set MODEM Use IRQ to 9.
 - 10 Set MODEM Use IRQ to 10.
 - 11 Set MODEM Use IRQ to 11.

Soft-off by Power Button

- Off The user press the power button once, he can turn off the system.
(Default Value)
- Suspend The user press the power button once, then he can enter suspend mode.

System after AC Back

- Last State When AC-power back to the system, the system will return to the Last state before AC-power off.
- Off When AC-power back to the system, the system will be in "Off" state.
(Default Value)
- On When AC-power back to the system, the system will be in "On" state.

IRQ [3-7, 9-15], NMI

- Disabled Disable this function.
- Enabled Enable this function. (Default value)

ModemRingOn/WakeOnLAN

An incoming call via modem awakes the system from its soft-off mode./When set at Enabled, an input signal comes from the other client/server on the LAN awarks the system from a soft off state if connected over LAN.

- Disabled Disable Modem Ring on/wake on Lan function.
- Enabled Enable Modem Ring on/wake on Lan. (Default Value)

PME Event Wake UP



When set at Enabled, any PCI-PM event awarkes the system from a PCI-PM controlled state

- Disabled Disable this function.



 Enabled Enable PME Event Wake up. (Default Value)

 **USB Device Wake-up From S3**

When set at Enabled, it allows USB Device to activate the system from ACPI S3 power saving mode.

 Enabled Enable USB Device Wakeup.
 Disabled Disable USB Device Wakeup. (Default Value)

 **Power On by Mouse**



 Enabled Enable PS2 Mouse Power Up Control function. (Default Value)
 Disabled Disable this function.

 **KB Power ON Password**

 Enter Input password (from 1 to 8 characters) and press Enter to set the Keyboard Power On Password.

 **Resume by Alarm**

You can set "Resume by Alarm" item to enabled and key in Data/time to power on system.

 Disabled Disable this function. (Default Value)
 Enabled Enable alarm function to POWER ON system.

If RTC Alarm Lead To Power On is Enabled.

Month Alarm : NA, 1~31

Day of Month Alarm : 1~31

Time (hh: mm: ss) Alarm : (0~23) : (0~59) : (0~59)

PnP/PCI Configurations

CMOS Setup Utility - Copyright (C) 1984-2002 Award Software

PnP/PCI Configurations

Resources Controlled By	[Auto]	Item Help
x IRQ Resources	Press Enter	Menu Level ↓
PCI1 IRQ Assignment	[Auto]	[Auto]
PCI2 IRQ Assignment	[Auto]	Assign PnP resource
PCI3 IRQ Assignment	[Auto]	(I/O address, IRQ & DMA channels) for Plug and Play compatible devices automatically
		[Manual] Assign resource manually
↓ ↓ ↓ ↓ ↓ ↓ : Move Enter: Select +/-/PU/PD: Value F10: Save ESC: Exit F1: General Help F5: Previous Values F6: Fail-Safe Defaults F7: Optimized Defaults		

Figure 7: PnP/PCI Configurations

Resources Controlled By

- Manual User can set the PnP resource (I/O Address, IRQ & DMA channels) used by legacy ISA DEVICE.
- Auto BIOS automatically use these PnP rescuers. (Default value)

IRQ Resources (3,4,5,7,9,10,11,12,14,15)

- PCI Device The resource is used by PCI device.
- Reserved Set the resource to reserved.

☞ **PCI1 IRQ Assignment**

- ☞ Auto Auto assign IRQ to PCI1. (Default v alue)
- ☞ 3,4,5,7,9,10,11,12,14,15 Set IRQ 3,4,5,7,9,10,11,12,14,15 to PCI4.

☞ **PCI2 IRQ Assignment**

- ☞ Auto Auto assign IRQ to PCI2. (Default v alue)
- ☞ 3,4,5,7,9,10,11,12,14,15 Set IRQ 3,4,5,7,9,10,11,12,14,15 to PCI1/5.

☞ **PCI3 IRQ Assignment**

- ☞ Auto Auto assign IRQ to PCI3. (Default v alue)
- ☞ 3,4,5,7,9,10,11,12,14,15 Set IRQ 3,4,5,7,9,10,11,12,14,15 to PCI2/6.

PC Health Status

CMOS Setup Utility - Copyright (C) 1984-2001 Award Software

PC Health Status

Reset Case Open Status	[Disabled]	Item Help
Case Status	[No]	Menu Level ↓
VCORE	1.71V	
+3.3V	3.29V	
+5V	4.99V	
+12V	11.73V	
Current System Temp.	27°C/ 80°F	
Current CPU Temperature	25°C/ 77°F	
Current CPU FAN Speed	4821 RPM	
Current System FAN Speed	0 RPM	
CPU Warning Temperature	[Disabled]	
System FAN Fail Warning	[Disabled]	
CPU FAN Fail Warning	[Disabled]	
↓ ↓ ↓ ↓ ↓ ↓ : Move Enter: Select +/-/PU/PD: Value F10: Save ESC: Exit F1: General Help F5: Previous Values F6: Fail-Safe Defaults F7: Optimized Defaults		

Figure8: PC Health Status

☞ Reset Case Open Status

☞ Case Status

If the case is closed, "Case Status" will show "Closed".

If the case have been opened, "Case Status" will show "Opened".

If you want to reset "Case Status" value, set "Reset Case Open Status" to "Yes" and save CMOS, your computer will restart.

☞ Current Voltage (V) VCORE / +3.3V / +5V / +12V

🔌 Detect system's voltage status automatically.

☞ **Current System Temperature**

☞ Detect System Temp. automatically.

☞ **Current CPU Temperature**

☞ Detect CPU Temp. automatically.

☞ **Current CPU Fan / System Fan Fan Speed (RPM)**

☞ Detect Fan speed status automatically.

☞ **CPU Warning Temperature**

☞ 60°C / 140°F Monitor CPU Temp. at 60°C / 140°F.

☞ 70°C / 158°F Monitor CPU Temp. at 70°C / 158°F.

☞ 80°C / 176°F Monitor CPU Temp. at 80°C / 176°F.

☞ 90°C / 194°F Monitor CPU Temp. at 90°C / 194°F.

☞ Disabled Disable this function.(Default value)

☞ **Fan Fail Alarm**

CPU/ System

☞ No Fan Fail Alarm Function Disable. (Default Value)

☞ Yes Fan Fail Alarm Function Enable.

Frequency/Voltage Control

CMOS Setup Utility-Copyright (C) 1984-2001 Award Software

Frequency/Voltage Control

Frequency/Voltage Control		Item Help
CPU Clock Ratio	[15X]	
Linear Frequency Control	[Disabled]	Menu Level ↓
⚙ CPU Clock	100	
⚙ DRAM Clock (MHz)	N/A	
⚙ AGP Clock (MHz)	N/A	
⚙ PCI Clock (MHz)	N/A	
CPU OverVoltage Control	[Normal]	
Normal CPU Vcore	1.750V	
↓ ↓ ↓ ↓ ↓ ↓ : Move Enter:Select +/-/PU/PD:Value F10:Save ESC:Exit F1:General Help F5:Previous Values F6:Fail-Safe Defaults F7:Optimized Defaults		

Figure 9: Frequency/Voltage Control

Note: If system hangs up before enter CMOS setup utility , wait for 20 sec for times out reboot . When time out occur, system will reset and run at CPU default Host clock at next boot.

⚙ Those items will be available when "Linear Frequency Control" is set to Enabled.

⚙ CPU Clock Ratio

⚙ 8X-24X It's depends on CPU Clock Ratio.

⚙ Linear Frequency Control

When set to "Enabled", you can adjust CPU / DRAM / AGP / PCI linear frequency . For power End-User use only .

⚙ Disabled Disable this function. (Default value)

⚙ Enabled Enable this function.

☞ **DRAM Clock (MHz)**

This feature allows you to adjust the DRAM frequency, When "Linear Frequency Control" is set to Enabled.

☞ Please set DRAM Clock according to your requirement.

If you use DDR200 DRAM module, please set "DRAM Clock(MHz)" to 100. If you use DDR333 DRAM module, please set "DRAM Clock(MHz)" to 166.

Incorrect using it may cause your system broken. For power End-User use only!

☞ **AGP Clock (MHz)**

This feature allows you to adjust the AGP frequency, When "Linear Frequency Control" is set to Enabled.

☞ Please set AGP Clock according to your requirement.

Incorrect using it may cause your system broken. For power End-User use only!

☞ **PCI Clock (MHz)**

This feature allows you to adjust the PCI frequency, When "Linear Frequency Control" is set to Enabled.

☞ Please set PCI Clock according to your requirement.

Incorrect using it may cause your system broken. For power End-User use only!

☞ **CPU OverVoltage Control**

☞ Supports adjustable CPU Vcore from 1.100V to 1.850V by 0.025V step.

(Default value: Normal)

☞ **Normal CPU Vcore**

☞ Display your CPU Vcore Voltage.

Load Optimized Defaults

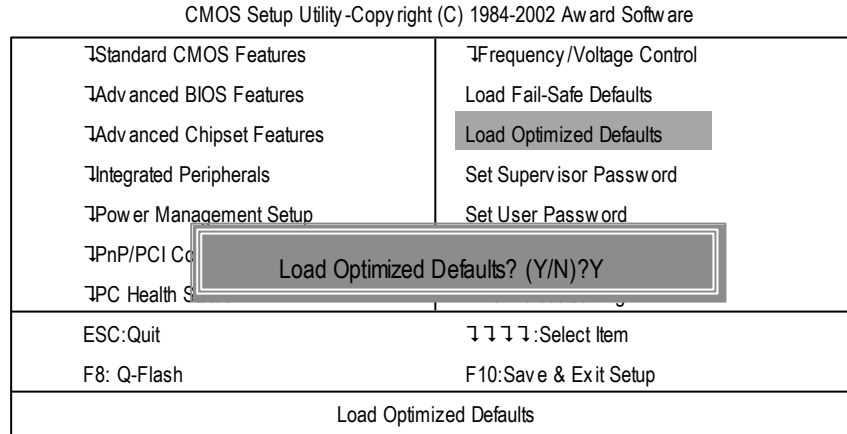

Figure 11: Load Optimized Defaults

Load Optimized Defaults

Selecting this field loads the factory defaults for BIOS and Chipset Features which the system automatically detects.

Set Supervisor/User Password

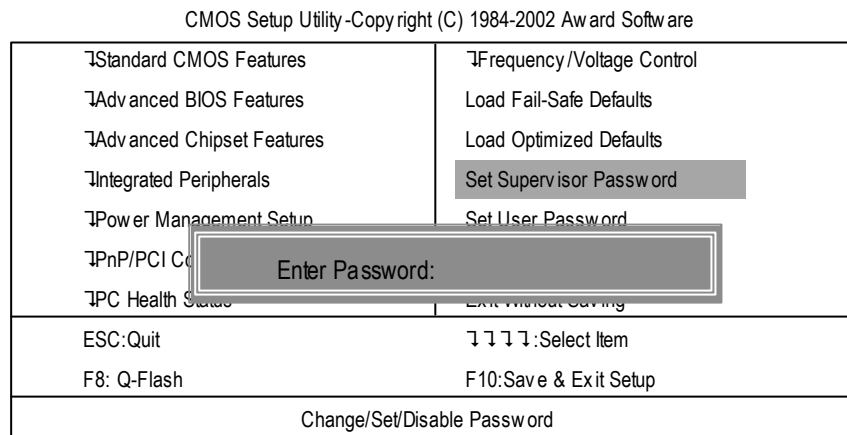

Figure 12: Password Setting

When you select this function, the following message will appear at the center of the screen to assist you in creating a password.

Type the password, up to eight characters, and press <Enter>. You will be asked to confirm the password. Type the password again and press <Enter>. You may also press <Esc> to abort the selection and not enter a password.

To disable password, just press <Enter> when you are prompted to enter password. A message "PASSWORD DISABLED" will appear to confirm the password being disabled. Once the password is disabled, the system will boot and you can enter Setup freely.

The BIOS Setup program allows you to specify two separate passwords:

SUPERVISOR PASSWORD and a USER PASSWORD. When disabled, anyone may access all BIOS Setup program function. When enabled, the Supervisor password is required for entering the BIOS Setup program and having full configuration fields, the User password is required to access only basic items.

If you select "System" at "Password Check" in Advance BIOS Features Menu, you will be prompted for the password every time the system is rebooted or any time you try to enter Setup Menu.

If you select "Setup" at "Password Check" in Advance BIOS Features Menu, you will be prompted only when you try to enter Setup.

Save & Exit Setup

CMOS Setup Utility - Copy right (C) 1984-2002 Award Software

↵Standard CMOS Features	↵Frequency/Voltage Control
↵Advanced BIOS Features	Load Fail-Safe Defaults
↵Advanced Chipset Features	Load Optimized Defaults
↵Integrated Peripherals	Set Supervisor Password
↵Power Management Setup	Set User Password
↵PnP/PCI C	Save to CMOS and EXIT (Y/N)? Y
↵PC Health Status	Exit without Saving
ESC:Quit	↑↑↑↑:Select Item
F8:Q-Flash	F10:Save & Exit Setup
Save Data to CMOS	

Figure 13: Save & Exit Setup

Type "Y" will quit the Setup Utility and save the user setup value to RTC CMOS.

Type "N" will return to Setup Utility.

Chapter 4 Technical Reference

Block Diagram

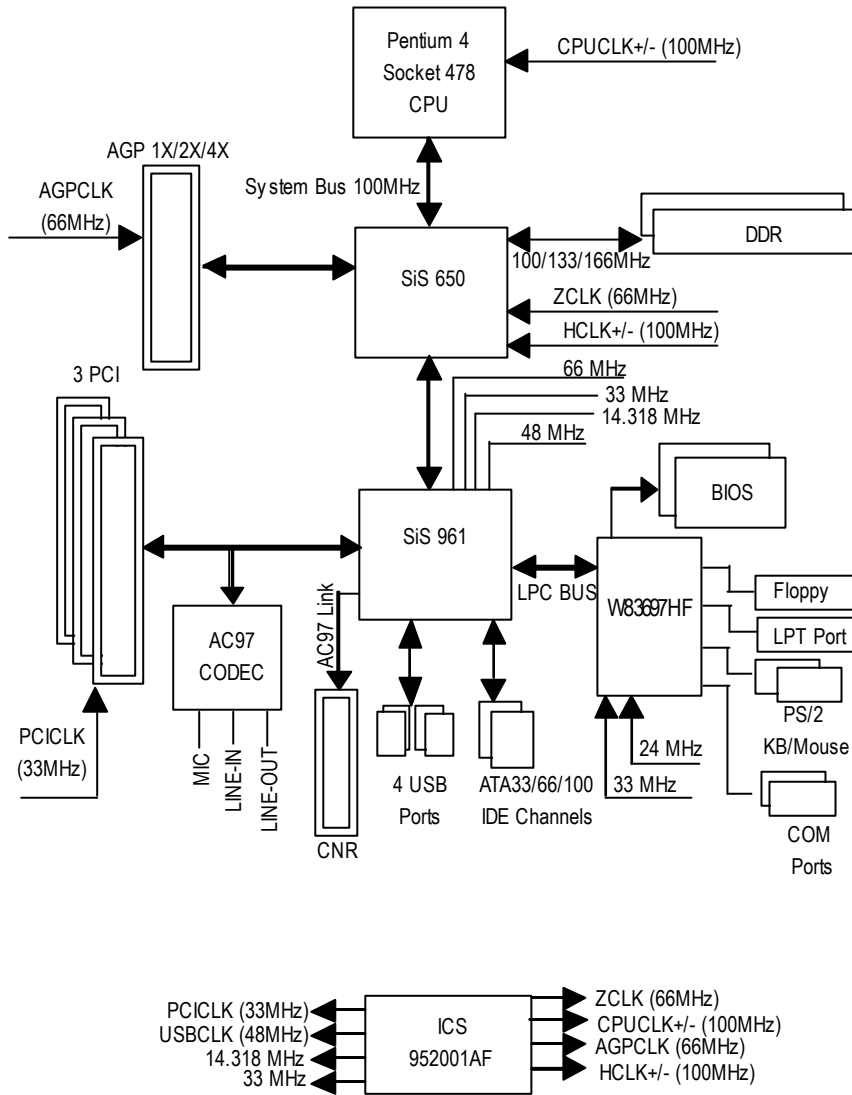

@ BIOS™ Introduction

Gigabyte announces @ BIOS Windows BIOS live update utility



Have you ever updated BIOS by yourself? Or like many other people, you just know what BIOS is, but always hesitate to update it? Because you think updating newest BIOS is unnecessary and actually you don't know how to update it.

Maybe not like others, you are very experienced in BIOS updating and spend quite a lot of time to do it. But of course you don't like to do it too much. First, download different BIOS from website and then switch the operating system to DOS mode. Secondly, use different flash utility to update BIOS. The above process is not a interesting job. Besides, always be carefully to store the BIOS source code correctly in your disks as if you update the wrong BIOS, it will be a nightmare.

Certainly, you wonder why motherboard vendors could not just do something right to save your time and effort and save you from the lousy BIOS updating work? Here it comes! Now Gigabyte announces @BIOS—the first Windows BIOS live update utility. This is a smart BIOS update software. It could help you to download the BIOS from internet and update it. Not like the other BIOS update software, it's a Windows utility. With the help of "@BIOS", BIOS updating is no more than a click.

Besides, no matter which mainboard you are using, if it's a Gigabyte's product*, @BIOS help you to maintain the BIOS. This utility could detect your correct mainboard model and help you to choose the BIOS accordingly. It then downloads the BIOS from the nearest Gigabyte ftp site automatically. There are several different choices; you could use "Internet Update" to download and update your BIOS directly. Or you may want to keep a backup for your current BIOS, just choose "Save Current BIOS" to save it first. You make a wise choice to use Gigabyte, and @BIOS update your BIOS smartly. You are now worry free from updating wrong BIOS, and capable to maintain and manage your BIOS easily. Again, Gigabyte's innovative product erects a milestone in mainboard industries.

For such a wonderful software, how much it costs? Impossible! It's free! Now, if you buy a Gigabyte's motherboard, you could find this amazing software in the attached driver CD. But please remember, connected to internet at first, then you could have a internet BIOS update from your Gigabyte @BIOS.

Chapter 5 Appendix

Picture below are shown in Windows ME (TUCD driver version 1.94)

Appendix A: SiS 650 Chipset Driver Installation (Must Install!)

A. SiS 650 VGA Driver Installation

Insert the driver CD-title that came with your motherboard into your CD-ROM driver, the driver CD-title will auto start and show the installation guide. If not, please double click the CD-ROM device icon in "My computer", and execute the setup.exe.



1. Click "SiS 650 VGA Driver" item.

(1)



2. Click "Next".

(2)

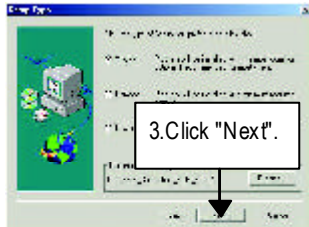

3. Click "Next".

(3)



4. Click "Next".

(4)



5. Click "Next".

(5)

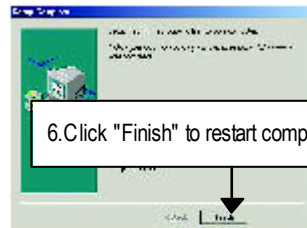

6. Click "Finish" to restart computer.

(6)

B: SiS AGP Driver Installation

Insert the driver CD-title that came with your motherboard into your CD-ROM driver, the driver CD-title will auto start and show the installation guide. If not, please double click the CD-ROM device icon in "My computer", and execute the setup.exe.



(1)



(2)

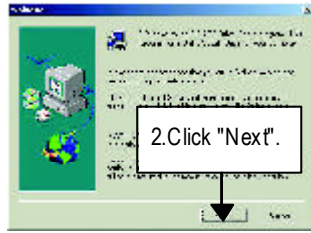

(3)



(4)



(5)

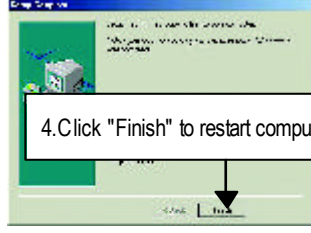

(6)

Appendix B: RealTek AC'97 Audio Driver

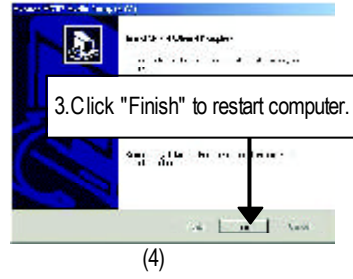
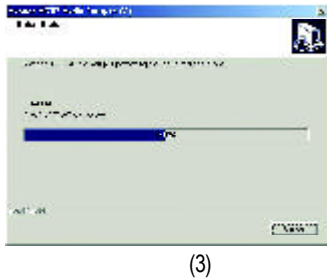
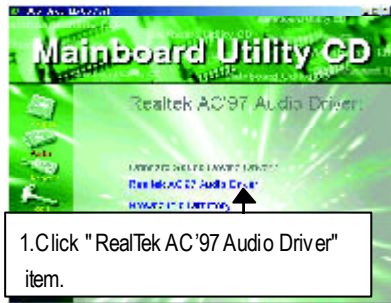

Appendix C: RealTek 8100/8139 Network Driver

"RealTek 8100/8139 Network Driver" under Windows ME will auto install. If you would like to install LAN driver, please refer to attached README.txt file for detail instruction. Please install the driver through CD-ROM by the path D:\Network\Rtl (This manual assumes that your CD-ROM device drive letter is D:).



Appendix D: BIOS Flash Procedure

BIOS update procedure:

If your OS is Win9X, we recommend that you used Gigabyte @BIOS™ Program to flash BIOS.

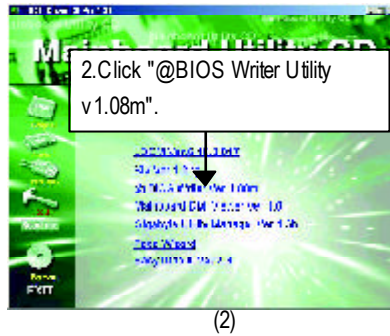
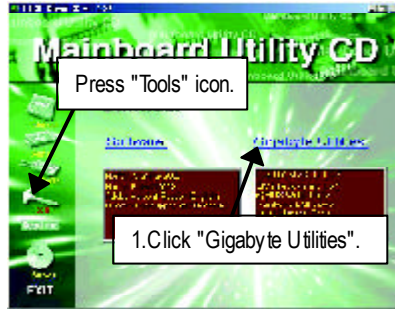

Methods and steps:

- I. Update BIOS through Internet
 - a. Click "Internet Update" icon
 - b. Click "Update New BIOS" icon
 - c. Select @BIOS™ sever ("Gigabyte @BIOS™ sever 1 in Taiwan" and "Gigabyte @BIOS™ sever 2 in Taiwan" are available for now, the others will be completed soon)
 - d. Select the exact model name on your motherboard
 - e. System will automatically download and update the BIOS.

II. Update BIOS NOT through Internet:

- a. Do not click "Internet Update" icon
- b. Click "Update New BIOS"
- c. Please select "All Files" in dialog box while opening the old file.
- d. Please search for BIOS unzip file, downloading from internet or any other methods (such as: 8SIML.F1).
- e. Complete update process following the instruction.

III. Save BIOS

In the very beginning, there is "Save Current BIOS" icon shown in dialog box. It means to save the current BIOS version.

IV. Check out supported motherboard and Flash ROM:

In the very beginning, there is "About this program" icon shown in dialog box. It can help you check out which kind of motherboard and which brand of Flash ROM are supported.

Note:

- a. In method I, if it shows two or more motherboard's model names to be selected, please make sure your motherboard's model name again. Selecting wrong model name will cause the system unbooted.
- b. In method II, be sure that motherboard's model name in BIOS unzip file are the same as your motherboard's. Otherwise, your system won't boot.
- c. In method I, if the BIOS file you need cannot be found in @BIOS™ server, please go onto Gigabyte's web site for downloading and updating it according to method II.
- d. Please note that any interruption during updating will cause system unbooted

We use GA-7V/TX motherboard and Flash841 BIOS flash utility as example.

Please flash the BIOS according to the following procedures if you are now under the DOS mode.

Flash BIOS Procedure:

STEP 1:

- (1) Please make sure you have set "Auto" for BIOS Feature Setup (BIOS Flash Protection). For more detail please refer to page 28.
- (2) Please make sure your system has installed the extraction utility such as winzip or pkunzip.
Firstly you have to install the extraction utility such as winzip or pkunzip for unzip the files. Both of these utilities are available on many shareware download pages like <http://www.shareware.cnet.com>

STEP 2: Make a DOS boot diskette. (See example: Windows 98 O.S.)

Beware: Windows ME/2000 are not allowed to make a DOS boot diskette.

- (1) With an available floppy disk in the floppy drive. Please leave the diskette "UN-write protected" type. Double click the "My Computer" icon from Desktop, then click "3.5 diskette (A)" and right click to select "Format (M)"

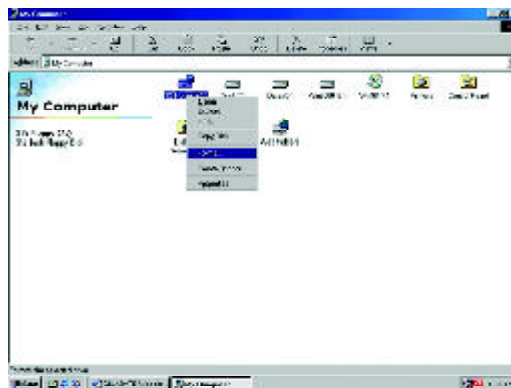

system files to it.

Beware: This procedure will erase all the prior data on that floppy, so please proceed accordingly

GA-8SiML Motherboard

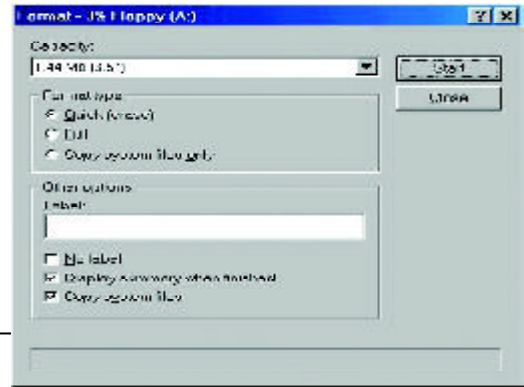

(3) After the floppy has been formatted completely, please press "Close".

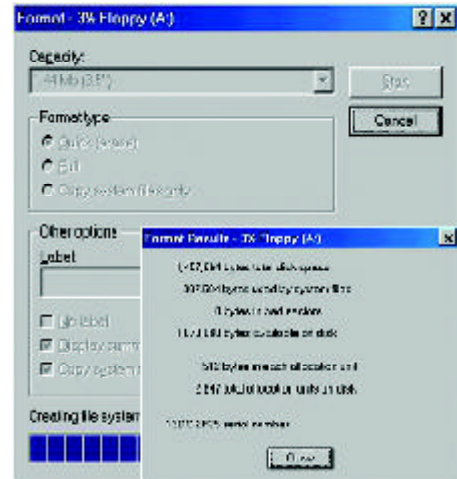

STEP 3: Download BIOS and BIOS utility program.

(1) Please go to Gigabyte website <http://www.gigabyte.com.tw/index.html>, and click "Support".



(2) From Support zone, click the "Motherboards BIOS & Drivers".

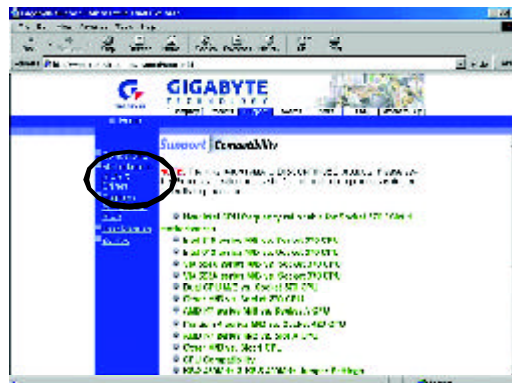

- (3) We use GA-7VTX motherboard as example. Please select GA-7VTX by Model or Chipset optional menu to obtain BIOS flash files.

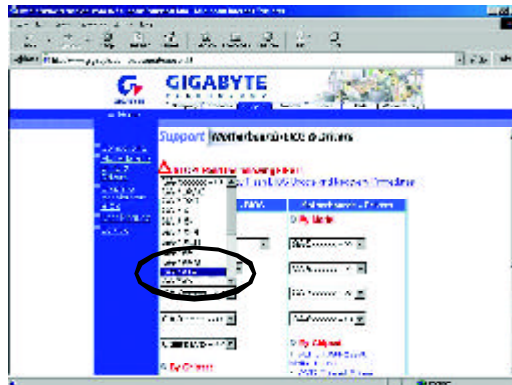

- (4) Select an appropriate BIOS version (For example: F4), and click to download the file. It will pop up a file download screen, then select the "Open this file from its current location" and press "OK".

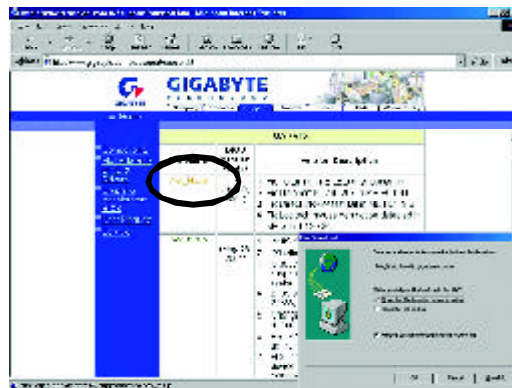

(5) At this time the screen shows the following picture, please click "Extract" button to unzip the files.

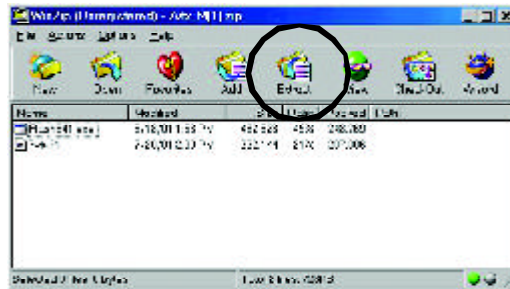

(6) Please extract the download files into the clean bootable floppy disk A mentioned in STEP 2, and press "Extract".

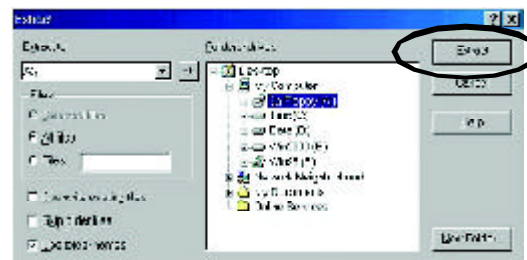

STEP 4: Make sure the system will boot from the floppy disk.

- (1) Insert the floppy disk (contains bootable program and unzip file) into the floppy drive A. Then, restart the system. The system will boot from the floppy disk. Please press key to enter BIOS setup main menu when system is boot up.



- (2) Once you enter the BIOS setup utility, the main menu will appear on the screen. Use the arrows to highlight the item "BIOS FEATURES SETUP".

AMIBIOS SIMPLE SETUP UTILITY - VERSION 1.24b (C) 1999 American Megatrends, Inc. All Rights Reserved	
STANDARD CMOS SETUP	INTEGRATED PERIPHERALS
BIOS FEATURES SETUP	HARDWARE MONITOR & MISC SETUP
CHIPSET FEATURES SETUP	SUPERVISOR PASSWORD
POWER MANAGEMENT SETUP	USER PASSWORD
PNP / PCI CONFIGURATION	IDE HDD AUTO DETECTION
LOAD BIOS DEFAULTS	SAVE & EXIT SETUP
LOAD SETUP DEFAULTS	EXIT WITHOUT SAVING
ESC: Quit ↓↓↓↓↓: Select Item (Shift)F2: Change Color F5: Old Values	
F6: Load BIOS Defaults F7: Load Setup Defaults F10: Save & Exit	
Time, Date, Hard Disk Type...	

- (3) Press "Enter" to enter "BIOS FEATURES SETUP" menu. Use the arrows to highlight the item "1st Boot Device", and then use the "Page Up" or "Page Down" keys to select "Floppy".

AMIBIOS SETUP - BIOS FEATURES SETUP	
(C) 2001 American Megatrends, Inc. All Rights Reserved	
1st Boot Device : Floppy	
2nd Boot Device : IDE-0	
3rd Boot Device : CDROM	
S.M.A.R.T. for Hard Disks : Disabled	
BootUp Num-Lock : On	ESC: Quit ↓ ↓ ↓ ↓ : Select Item
Floppy Drive Seek : Disabled	F1 : Help PU/PD/+/- : Modify
Password Check : Setup	F5 : Old Values (Shift)F2: Color
	F6 : Load BIOS Defaults
	F7 : Load Setup Defaults

- (4) Press "ESC" to go back to previous screen. Use the arrows to highlight the item "SAVE & EXIT SETUP" then press "Enter". System will ask "SAVE to CMOS and EXIT (Y/N)?" Press "Y" and "Enter" keys to confirm. Now the system will reboot automatically, the new BIOS setting will be taken effect next boot-up.

AMIBIOS SIMPLE SETUP UTILITY - VERSION 1.24b	
(C) 2001 American Megatrends, Inc. All Rights Reserved	
STANDARD CMOS SETUP	INTEGRATED PERIPHERALS
BIOS FEATURES SETUP	HARDWARE MONITOR & MISC SETUP
CHIPSET FEATURES SETUP	SUPERVISOR PASSWORD
POWER MANAGEMENT SETUP	USER PASSWORD
PNP / PCI CONF	SAVE to CMOS and EXIT (Y/N)? Y
LOAD BIOS DEFAULTS	SAVE & EXIT SETUP
LOAD SETUP DEFAULTS	EXIT WITHOUT SAVING
ESC: Quit ↓ ↓ ↓ ↓ : Select Item (Shift)F2 : Change Color F5: Old Values	
F6: Load BIOS Defaults F7: Load Setup Defaults F10: Save & Exit	
Save Data to CMOS & Exit SETUP	

STEP 5: BIOS flashing.

- (1) After the system boot from floppy disk, type "A:\> dir/w" and press "Enter" to check the entire files in floppy A. Then type the "BIOS flash utility" and "BIOS file" after A:\>. In this case you have to type "A:\> Flash841 7VTX.F4" and then press "Enter".

```
Starting Windows 98...

Microsoft(R) Windows98
© Copyright Microsoft Corp 1981-1999

A:\> dir/w
Volume in drive A has no label
Volume Serial Number is 16EB-353D
Directory of A:\
COMMAND.COM  7VTX.F4  FLASH841.EXE
              3 file(s)  838,954 bytes
              0 dir(s)  324,608 bytes free

A:\> Flash841 7VTX.F4
```

- (2) Now screen appears the following Flash Utility main menu. Press "Enter", the highlighted item will locate on the model name of the right-upper screen. Right after that, press "Enter" to start BIOS Flash Utility.

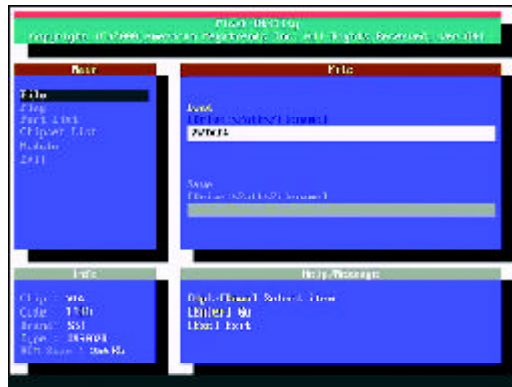

- (3) It will pop up a screen and asks "Are you sure to flash the BIOS?" Press [Enter] to continue the procedure, or press [ESC] to quit.

Beware: Please do not turn off the system while you are upgrading BIOS. It will render your BIOS corrupted and system totally inoperative.

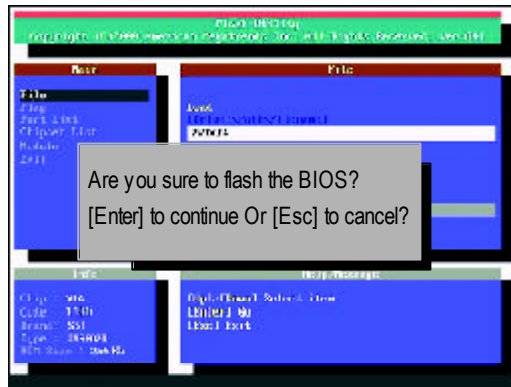

- (4) The BIOS flash completed. Please press [ESC] to exit Flash Utility.



STEP 6: Load BIOS defaults.

Normally the system redetects all devices after BIOS has been upgraded. Therefore, we highly recommend reloading the BIOS defaults after BIOS has been upgraded. This important step resets everything after the flash.

- (1) Take out the floppy diskette from floppy drive, and then restart the system. The boot up screen will indicate your motherboard model and current BIOS version.

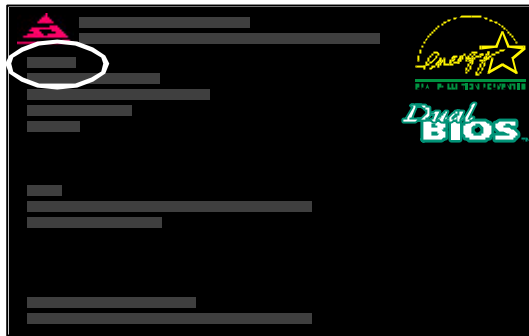

- (2) Don't forget to press key to enter BIOS setup again when system is boot up. Use the arrows to highlight the item "LOAD SETUP DEFAULTS" then press "Enter". System will ask "Load Setup Defaults (Y/N)?" Press "Y" and "Enter" keys to confirm.

AMIBIOS SIMPLE SETUP UTILITY - VERSION 1.24b (C) 2001 American Megatrends, Inc. All Rights Reserved	
STANDARD CMOS SETUP	INTEGRATED PERIPHERALS
BIOS FEATURES SETUP	HARDWARE MONITOR & MISC SETUP
CHIPSET FEATURES SETUP	SUPERVISOR PASSWORD
POWER MANAGEMENT SETUP	MOUSE PASSWORD
PNP / PCI CONFIGURATION	Load Setup Defaults? (Y/N)?N
LOAD BIOS DEFAULTS	SAVE & EXIT SETUP
LOAD SETUP DEFAULTS	EXIT WITHOUT SAVING
ESC: Quit ↑ ↓ ← → : Select Item (Shift)F2: Change Color F5: Old Values F6: Load BIOS Defaults F7: Load Setup Defaults F10: Save & Exit	
Load Setup Defaults	

- (3) Use the arrows to highlight the item "SAVE & EXIT SETUP" and press "Enter". System will ask "SAVE to CMOS and EXIT (Y/N)?" Press "Y" and "Enter" keys to confirm. Now the system will reboot automatically, the new BIOS setting will be taken effect next boot-up.

AMIBIOS SIMPLE SETUP UTILITY - VERSION 1.24b (C) 2001 American Megatrends, Inc. All Rights Reserved	
STANDARD CMOS SETUP	INTEGRATED PERIPHERALS
BIOS FEATURES SETUP	HARDWARE MONITOR & MISC SETUP
CHIPSET FEATURES SETUP	SUPERVISOR PASSWORD
POWER MANAGEMENT SETUP	USER PASSWORD
PNP / PCI CONF	SAVE & EXIT SETUP
LOAD BIOS DEFAULTS	EXIT WITHOUT SAVING
LOAD SETUP DEFAULTS	
ESC: Quit ↑↓←→ : Select Item (Shift)F2 : Change Color F5: Old Values F6: Load BIOS Defaults F7: Load Setup Defaults F10: Save & Exit	
Save Data to CMOS & Exit SETUP	

- (4) Congratulate you have accomplished the BIOS flash procedure.

Appendix D: Acronyms

Acronyms	Meaning
ACPI	Advanced Configuration and Power Interface
APM	Advanced Power Management
AGP	Accelerated Graphics Port
AMR	Audio Modem Riser
ACR	Advanced Communications Riser
BIOS	Basic Input / Output System
CPU	Central Processing Unit
CMOS	Complementary Metal Oxide Semiconductor
CRIMM	Continuity RIMM
CNR	Communication and Networking Riser
DMA	Direct Memory Access
DMI	Desktop Management Interface
DIMM	Dual Inline Memory Module
DRM	Dual Retention Mechanism
DRAM	Dynamic Random Access Memory
DDR	Double Data Rate
ECP	Extended Capabilities Port
ESCD	Extended System Configuration Data
ECC	Error Checking and Correcting
EMC	Electromagnetic Compatibility
EPP	Enhanced Parallel Port
ESD	Electrostatic Discharge
FDD	Floppy Disk Device
FSB	Front Side Bus
HDD	Hard Disk Device
IDE	Integrated Dual Channel Enhanced
IRQ	Interrupt Request
I/O	Input / Output
IOAPIC	Input Output Advanced Programmable Input Controller
ISA	Industry Standard Architecture
LAN	Local Area Network

to be continued.....

Acronyms	Meaning
LBA	Logical Block Addressing
LED	Light Emitting Diode
MHz	Megahertz
MIDI	Musical Instrument Digital Interface
MTH	Memory Translator Hub
MPT	Memory Protocol Translator
NIC	Network Interface Card
OS	Operating System
OEM	Original Equipment Manufacturer
PAC	PCI A.G.P. Controller
POST	Power-On Self Test
PCI	Peripheral Component Interconnect
RIMM	Rambus in-line Memory Module
SCI	Special Circumstance Instructions
SECC	Single Edge Contact Cartridge
SRAM	Static Random Access Memory
SMP	Symmetric Multi-Processing
SMI	System Management Interrupt
USB	Universal Serial Bus
VID	Voltage ID

Technical Support/RMA Sheet

Customer/Country :	Company :	Phone No.:
Contact Person:	E-mail Add. :	

Model name/Lot Number:	PCB revision:
BIOS version:	O.S./A.S.:

Hardware Configuration	Mfs.	Model name	Size:	Driver/Utility:
CPU				
Memory				
Brand				
Video Card				
Audio Card				
HDD				
CD-ROM / DVD-ROM				
Modem				
Network				
AMR / CNR				
Keyboard				
Mouse				
Power supply				
Other Device				

Problem Description:
