



- ✍ The author assumes no responsibility for any errors or omissions that may appear in this document nor does the author make a commitment to update the information contained herein.
- ✍ Third-party brands and names are the property of their respective owners.
- ✍ Please do not remove any labels on motherboard, this may void the warranty of this motherboard.
- ✍ Due to rapid change in technology, some of the specifications might be out of date before publication of this booklet.



Mise en garde : Ne faites jamais retirer le processeur sans que le dissipateur de chaleur soit fixé correctement et fermement car UN DOMMAGE PERMANENT EN RÉSULTE !

Achtung: Der Prozessor darf nur im Betrieb genommen werden, wenn der Wärmehaube ordnungsgemäß und fest angebracht ist. DIES KÖNNT EINEN PERMANENTEN SCHADEN ZUR FOLGE HABEN!

Advertencia: Nunca desmonte el procesador sin el disipador de calor correctamente y firmemente. SE PRODUCIRÁ UN DAÑO PERMANENTE.

Atenção: Nunca execute o processador sem o dissipador de calor estar adequadamente e firmemente montado. O RESULTADO SERÁ UM DANO PERMANENTE.

警告：務必於安裝前將散熱器安裝妥當且固定，否則這將導致永久損傷！

警告：安裝處理器前必須將散熱器安裝妥當且固定，否則這將導致永久損傷。

경고: 컴퓨터를 작동하기 전에 열 방출기(쿨러)를 올바르게 설치하고 단단히 고정하십시오. 그렇지 않으면 영구적인 손상을 입을 수 있습니다.

警告：務必於安裝前將散熱器安裝妥當且固定，否則這將導致永久損傷。

## Declaration of Conformity

We, Manufacturer/Importer  
(full address)

**G.B.T. Technology Trading GmbH**  
Ausschlagweg 41, 1F, 20537 Hamburg, Germany

declare that the product  
(description of the apparatus, system, installation to which it refers)

**Mother Board**  
GA-8 SMM-L

is in conformity with  
(reference to the specification under which conformity is declared)  
in accordance with 89/336 EEC-EMC Directive

EN 55011	Limits and methods of measurement of radio disturbance characteristics of industrial, scientific and medical (ISM) high frequency equipment	EN 61000-3-2* EN 61555-2	Disturbances in supply systems cause by household appliances and similar electrical equipment " Harmonics"
EN 55013	Limits and methods of measurement of radio disturbance characteristics of broadcast receivers and associated equipment	EN 61000-3-3* EN 61555-3	Disturbances in supply systems cause by household appliances and similar electrical equipment " Voltage fluctuations"
EN 55014	Limits and methods of measurement of radio disturbance characteristics of household electrical appliances, portable tools and similar electrical apparatus	EN 5081-1 EN 5082-1	Generic emission standard Part 1: Residual commercial and light industry Generic immunity standard Part 1: Residual commercial and light industry
EN 55015	Limits and methods of measurement of radio disturbance characteristics of fluorescent lamps and luminaries	EN 5081-2	Generic emission standard Part 2: Industrial environment
EN 55020	Immunity from radio interference of broadcast receivers and associated equipment	EN 5082-2	Generic emission standard Part 2: Industrial environment
EN 55022	Limits and methods of measurement of radio disturbance characteristics of information technology equipment	ENV 55104	Immunity requirements for household appliances tools and similar apparatus
DIN VDE 0855 part 10 part 12	Cabled distribution systems: Equipment for receiving and/or distribution from sound and television signals	EN 50091-2	EMC requirements for uninterruptible power systems (UPS)
CE marking			(EC conformity marking)

The manufacturer also declares the conformity of above mentioned product with the actual required safety standards in accordance with LVD 73/23/EEC

EN 60065	Safety requirements for mains operated electronic and related apparatus for household and similar general use	EN 60950
EN 60335	Safety of household and similar electrical appliances	EN 50091-1

Manufacturer/Importer

(S to mp)

Date: Jan 24, 2002

Signature: Timmy Huang  
Name: Timmy Huang

## **DECLARATION OF CONFORMITY**

Per FCC Part 2 Section 2.1077(a)



**Responsible Party Name: G.B.T. INC. (U.S.A.)**

**Address: 17358 Railroad Street**

**City of Industry, CA 91748**

**Phone/Fax No: (818) 854-9338 / (818) 854-9339**

hereby declares that the product

**Product Name: Motherboard**

**Model Number: GA-8SMML**

Conforms to the following specifications:

FCC Part 15, Subpart B, Section 15.107(a) and Section 15.109  
(a), Class B Digital Device

### **Supplementary Information:**

This device complies with part 15 of the FCC Rules. Operation is subject to the following two conditions: (1) This device may not cause harmful and (2) this device must accept any interference received, including that may cause undesired operation.

Representative Person's Name: ERIC LU

Signature: Eric Lu

Date: Jan. 24, 2002

GA-8SMML  
P4 Titan-SDRAM Motherboard

# **USER'S MANUAL**

Pentium®4 Processor Motherboard  
Rev. 1.0 Second Edition  
12ME-8SMML-1002

## **Table of Content**

Revision History .....	4
Item Checklist .....	4
WARNING! .....	5
Chapter 1 Introduction .....	6
Features Summary.....	6
GA-8SMML Motherboard Layout .....	8
Chapter 2 Hardware Installation Process .....	9
Step 1: Install the Central Processing Unit (CPU) .....	10
CPU Installation .....	10
CPU Heat Sink Installation .....	11
Step 2: Install memory modules .....	12
Step 3: Install expansion cards .....	13
Step 4: Connect ribbon cables, cabinet wires, and power supply .....	14
I/O Back Panel Introduction .....	14
Connectors Introduction .....	16
Chapter 3 BIOS Setup .....	22
The Main Menu (For example: BIOS Ver. :F1) .....	23
Standard CMOS Features .....	25
BIOS Features Setup .....	28
Chipset Features Setup .....	30
Power Management Setup .....	34
PnP/PCI Configuration .....	36

Load Fail-Safe Defaults .....	38
Load Optimized Defaults .....	39
Integrated Peripherals .....	40
Hardware Monitor & MISC Setup .....	46
Set Supervisor/User Password .....	48
IDE HDD Auto-Detection .....	49
Save & Exit Setup .....	50
Exit Without Saving .....	51
Chapter 4 Technical Reference .....	52
Block Diagram .....	52
@ BIOS Introduction .....	53
Chapter 5 Appendix .....	54

## Revision History

Revision	Revision Note	Date
1.0	Initial release of the GA-8SMML motherboard user's manual.	Jan. 2002
1.0	Second release of the GA-8SMML motherboard user's manual.	Feb. 2002

## Item Checklist

- ✍ The GA-8SMML motherboard
- ✍ IDE cable x 1/ Floppy cable x 1
- ✍ CD for motherboard driver & utility (TUCD)
- ✍ GA-8SMML user's manual
- ✍ Internal COM B Cable (Optional)

---

## WARNING!



Computer motherboards and expansion cards contain very delicate Integrated Circuit (IC) chips. To protect them against damage from static electricity, you should follow some precautions whenever you work on your computer.

1. Unplug your computer when working on the inside.
2. Use a grounded wrist strap before handling computer components. If you do not have one, touch both of your hands to a safely grounded object or to a metal object, such as the power supply case.
3. Hold components by the edges and try not touch the IC chips, leads or connectors, or other components.
4. Place components on a grounded antistatic pad or on the bag that came with the components whenever the components are separated from the system.
5. Ensure that the ATX power supply is switched off before you plug in or remove the ATX power connector on the motherboard.

### Installing the motherboard to the chassis...

If the motherboard has mounting holes, but they don't line up with the holes on the base and there are no slots to attach the spacers, do not become alarmed you can still attach the spacers to the mounting holes. Just cut the bottom portion of the spacers (the spacer may be a little hard to cut off, so be careful of your hands). In this way you can still attach the motherboard to the base without worrying about short circuits. Sometimes you may need to use the plastic springs to isolate the screw from the motherboard PCB surface, because the circuit wire may be near by the hole. Be careful, don't let the screw contact any printed circuit write or parts on the PCB that are near the fixing hole, otherwise it may damage the board or cause board malfunctioning.



## Chapter 1 Introduction

### Features Summary

Form Factor	☞ 22.9cm x 24.3cm Micro ATX size form factor, 4 layers PCB.
CPU	☞ Socket 478 for Intel® Micro FC-PGA2 Pentium® 4 processor ☞ Support Intel® Pentium® 4 (Northwood, 0.13um) processor ☞ Intel Pentium®4 400MHz FSB ☞ 2nd cache depend on CPU
Chipset	☞ SiS 650 Host/Memory controller ☞ SiS 961 MuTIO/L Media I/O
Memory	☞ 3 168-pin DIMM sockets ☞ Supports PC-100/PC-133 SDRAM (Auto) ☞ Supports only 3.3V SDRAM DIMM ☞ No Registered DIMM support ☞ Supports up to 3GB SDRAM (Max)
I/O Control	☞ W83697HF
Slots	☞ 1 Universal AGP slot (1X/2X/4X) device support ☞ 3 PCI slot supports 33MHz & PCI 2.2 compliant ☞ 1 CNR(Communication and Networking Riser) Slot
On-Board IDE	☞ 2 IDE bus master (UDMA33/ATA66/ATA100) IDE ports for up to 4 ATAPI devices ☞ Supports PIO mode3,4 (UDMA33/ATA66/ATA100) IDE & ATAPI CD-ROM
On-Board Peripherals	☞ 1 Floppy port supports 2 FDD with 360K, 720K, 1.2M, 1.44M and 2.88M bytes. ☞ 1 Parallel port supports Normal/EPP/ECP mode ☞ 2 Serial ports (COMA&VGA), COMB on board ☞ 4 USB ports (Rear USB x 2) ☞ 1 IrDA connector for IR
Hardware Monitor	☞ CPU/System Fan Revolution detect ☞ CPU/System Fan Control ☞ CPU Overheat Warning ☞ System Voltage Detect

to be continued.....

---

On-Board Sound	☞ Sigmatel 9721 CODEC ☞ Line In/Line Out/Mic In/CD In/Game Port
On-Board LAN	☞ Built in RTL8100 Chipset ☞ 1 RJ45 port
On-Board VGA	☞ Built in SiS650 Chipset
PS/2 Connector	☞ PS/2 Keyboard interface and PS/2 Mouse interace
BIOS	☞ Licensed AMI BIOS, 2M bit Flash ROM
Additional Features	☞ PS/2 Keyboard power on by password ☞ PS/2 Mouse power on ☞ STR(Suspend-To-RAM) ☞ AC Recovery ☞ USB KB/Mouse wake up from S3 ☞ Supports @BIOS

---



Please set the CPU host frequency in accordance with your processor's specifications. We don't recommend you to set the system bus frequency over the CPU's specification because these specific bus frequencies are not the standard specifications for CPU, chipset and most of the peripherals. Whether your system can run under these specific bus frequencies properly will depend on your hardware configurations, including CPU, Chipsets, SDRAM, Cards....etc.

## GA-8SMML Motherboard Layout

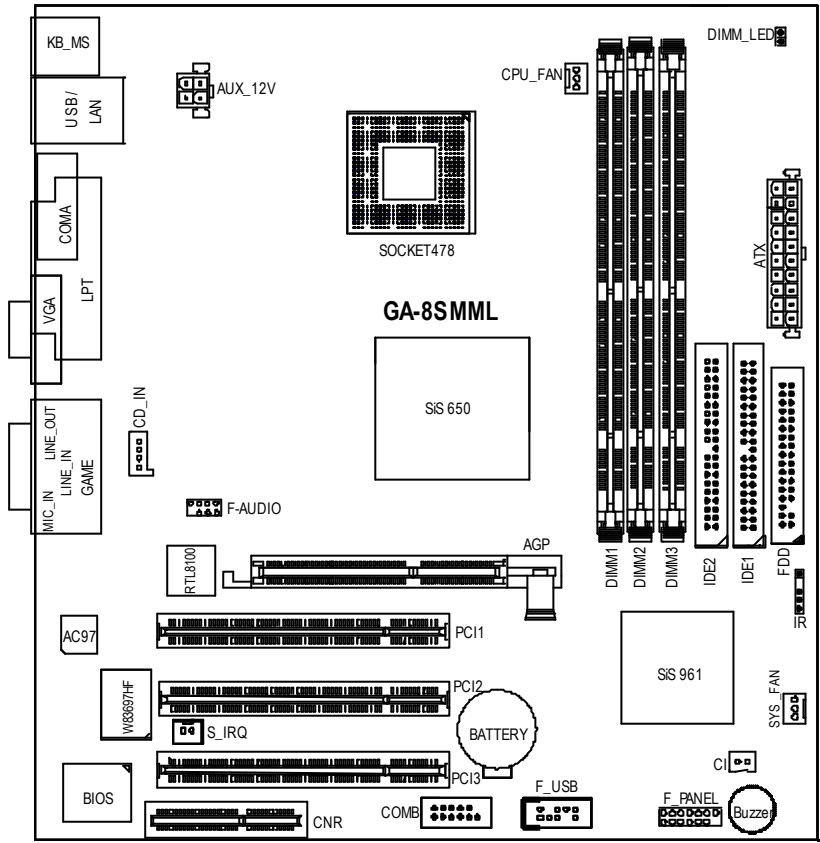

## Chapter 2 Hardware Installation Process

To setup your computer, you must complete the following steps:

- Step 1- Install the Central Processing Unit (CPU)
- Step 2- Install memory modules
- Step 3- Install expansion cards
- Step 4- Connect ribbon cables, cabinet wires, and power supply
- Step 5- Setup BIOS software
- Step 6- Install supporting software tools

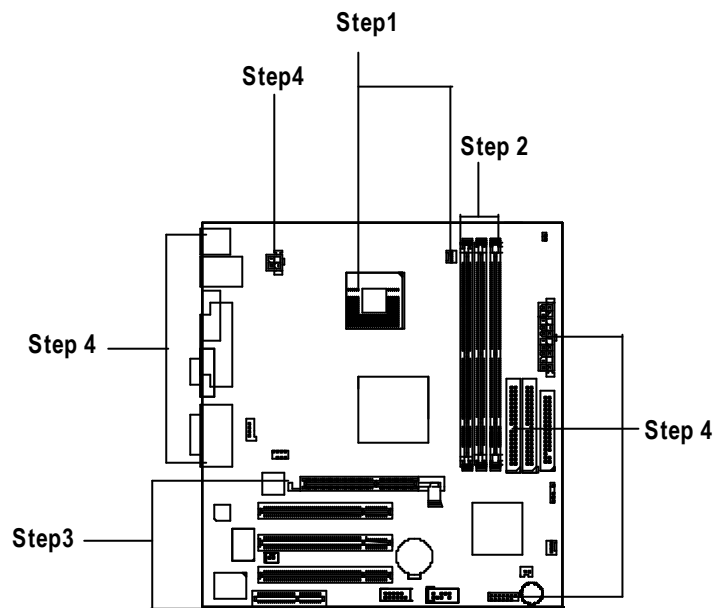

## Step 1: Install the Central Processing Unit (CPU)

### CPU Installation



CPU Top View

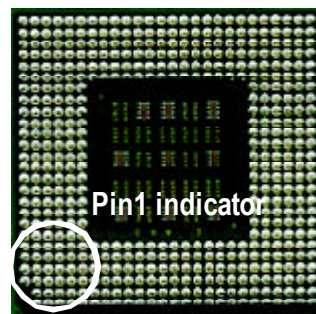

CPU Bottom View

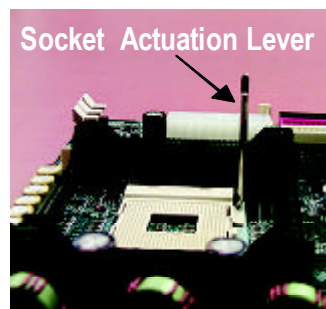

1. Pull up the CPU socket lever and up to 90-degree angle.
3. Press down the CPU socket lever and finish CPU installation.



2. Locate Pin 1 in the socket and look for a (golden) cut edge on the CPU upper corner. Then insert the CPU into the socket.

- ⚠ Please make sure the CPU type is supported by the motherboard.
- ⚠ If you do not match the CPU socket Pin 1 and CPU cut edge well, it will cause improper installation. Please change the insert orientation.

## CPU Heat Sink Installation

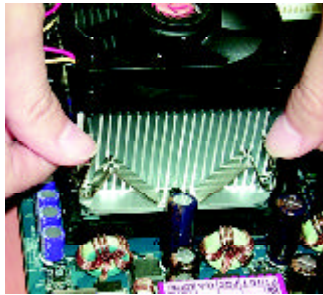

1. Hook one end of the cooler bracket to the CPU socket first.

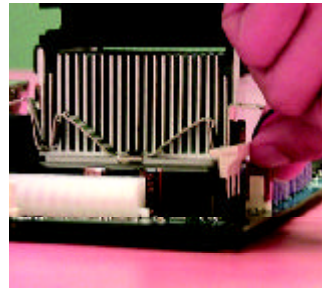

2. Hook the other end of the cooler bracket to the CPU socket.

- ✍ **Please use Intel approved cooling fan.**
- ✍ **We recommend you to apply the thermal tape to provide better heat conduction between your CPU and heatsink.**  
(The CPU cooling fan might stick to the CPU due to the hardening of the thermal paste. During this condition if you try to remove the cooling fan, you might pull the processor out of the CPU socket along with the cooling fan, and might damage the processor. To avoid this from happening, we suggest you to either use thermal tape instead of thermal paste, or remove the cooling fan with extreme caution.)
- ✍ **Make sure the CPU fan power cable is plugged in to the CPU fan connector, this completes the installation.**
- ✍ **Please refer to CPU heat sink user's manual for more detail installation procedure.**

## Step 2: Install memory modules

The motherboard has 3 dual in-line memory module (DIMM) sockets. The BIOS will automatically detects memory type and size. To install the memory module, just push it vertically into the DIMM Slot. The DIMM module can only fit in one direction due to the two notch. Memory size can vary between sockets.

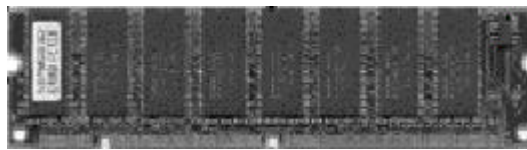

SDRAM

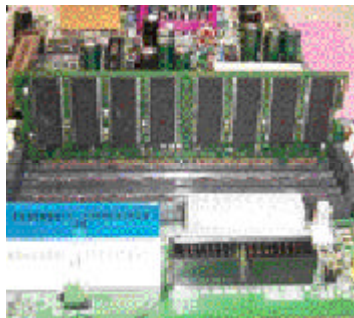

1. The DIMM slot has two notch, so the DIMM memory module can only fit in one direction.
2. Insert the DIMM memory module vertically into the DIMM slot. Then push it down.
3. Close the plastic clip at both edges of the DIMM slots to lock the DIMM module. Reverse the installation steps when you wish to remove the DIMM module.

✎ **Please note that the DIMM module can only fit in one direction due to the one notches. Wrong orientation will cause improper installation. Please change the insert orientation.**

### Step 3: Install expansion cards

1. Read the related expansion card's instruction document before install the expansion card into the computer.
2. Remove your computer's chassis cover, necessary screws and slot bracket from the computer.
3. Press the expansion card firmly into expansion slot in motherboard.
4. Be sure the metal contacts on the card are indeed seated in the slot.
5. Replace the screw to secure the slot bracket of the expansion card.
6. Replace your computer's chassis cover.
7. Power on the computer, if necessary, setup BIOS utility of expansion card from BIOS.
8. Install related driver from the operating system.

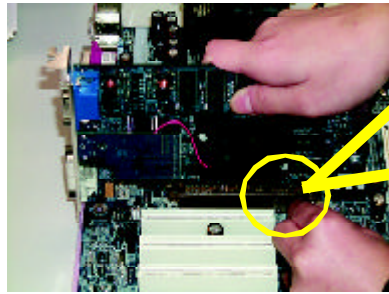

AGP Card

Please carefully pull out the small white-drawable bar at the end of the AGP slot when you try to install/ Uninstall the AGP card. Please align the AGP card to the onboard AGP slot and press firmly down on the slot . Make sure your AGP card is locked by the small white- drawable bar.



## Step 4: Connect ribbon cables, cabinet wires, and power supply

### Step4-1:I/O Back Panel Introduction

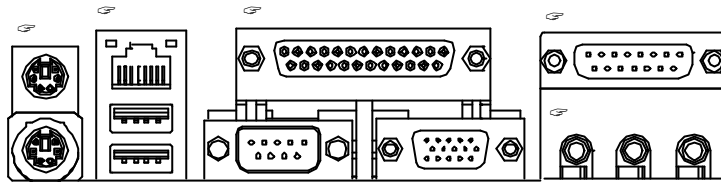

#### ☞ PS/2 Keyboard and PS/2 Mouse Connector



PS/2 Mouse Connector  
(6 pin Female)

PS/2 Keyboard Connector  
(6 pin Female)

☞ This connector supports standard PS/2 keyboard and PS/2 mouse.

#### ☞ USB & LAN Connector

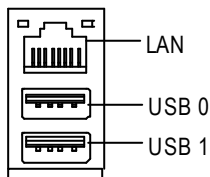

LAN

USB 0

USB 1

☞ Before you connect your device(s) into USB connector(s), please make sure your device(s) such as USB keyboard, mouse, scanner, zip, speaker...etc. Have a standard USB interface. Also make sure your OS (Win 95 with USB supplement, Win98, Windows 2000, Windows ME, Win NT with SP 6) supports USB controller. If your OS does not support USB controller, please contact OS vendor for possible patch or driver upgrade. For more information please contact your OS or device(s) vendors.

☞ **Parallel Port , Serial Port and VGA Port (LPT/COMA/VGA)**

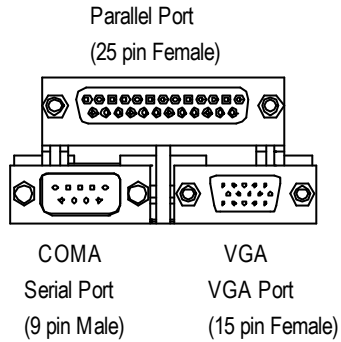

☞ This connector supports 1 standard COM port , 1 Parallel port and 1 VGA port. Device like printer can be connected to Parallel port ; mouse and modem etc can be connected to Serial ports.

☞ **Game /MIDI Ports**

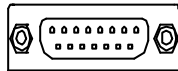

Joy stick/ MIDI (15 pin Female)

☞ This connector supports joystick, MIDI keyboard and other relate audio devices.

☞ **Audio Connectors**

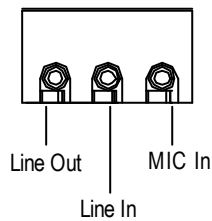

☞ After install onboard audio driver, you may connect speaker to Line Out jack, micro phone to MIC Injack. Device like CD-ROM , walkman etc can be connected to Line-In jack.

## Connectors Introduction

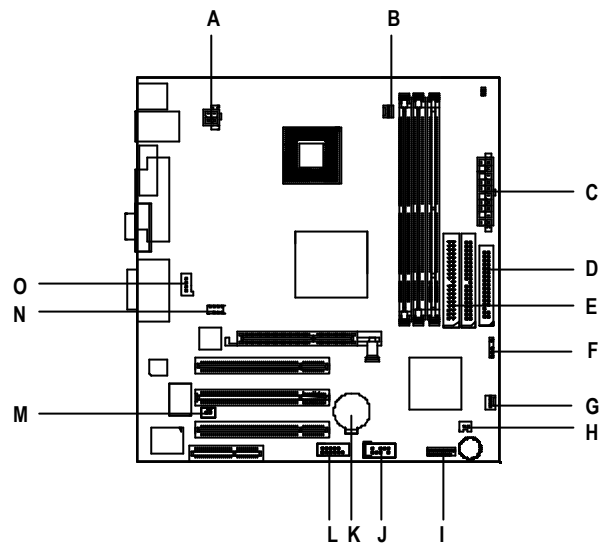

A) AUX_12V	I) F_PANEL
B) CPU_FAN	J) F_USB
C) ATX	K) BAT
D) FLOPPY	L) COMB
E) IDE1/IDE2	M) S_IRQ
F) IR	N) F_AUDIO
G) SYS_FAN	O) CD_IN
H) CI	

**A) AUX\_12V ( +12V Power Connector)**

⚡ This connector (ATX +12V) supplies the CPU operation voltage (V<sub>core</sub>).  
If this " ATX+ 12V connector" is not connected, system cannot boot.

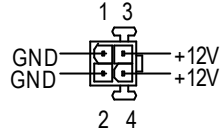

**B) CPU\_FAN (CPU FAN Connector)**

⚡ Please note, a proper installation of the CPU cooler is essential to prevent the CPU from running under abnormal condition or damaged by overheating. The CPU fan connector supports Max. current up to 600 mA.

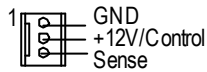

**G) SYS\_FAN (System FAN Connector)**

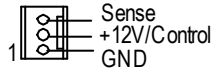

**H) CI (CASE OPEN)**

⚡ This 2 pin connector allows your system to enable or disable the system alarm if the system case begins to remove.

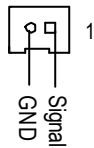

**D) FDD (Floppy Connector)**

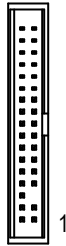

**E) IDE1/ IDE2 (IDE1/IDE2 Connector)**

 Important Notice:  
Please connect first harddisk to IDE1  
and connect CDROM to IDE2.

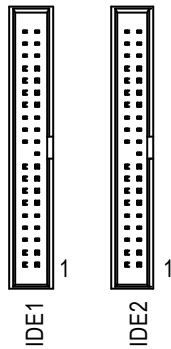

**L) COM B**

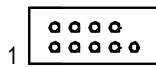

**O) CD\_IN (CD Audio Line In)**

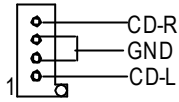

**N) F\_AUDIO (Front Audio Connector)**

If you want to use "Front Audio" connector, you must move 3-4,5-6 Jumper. In order to utilize the front audio header, your chassis must have front audio connector. Also please make sure the pin assignment on the cable is the same as the pin assignment on the MB header. To find out if the chassis you are buying support front audio connector, please contact your dealer.

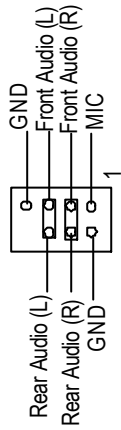

**M) S\_IRQ**

(For special design, for example: PCMCIA add on card)

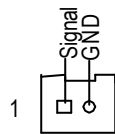

**C ) ATX (ATX Power)**

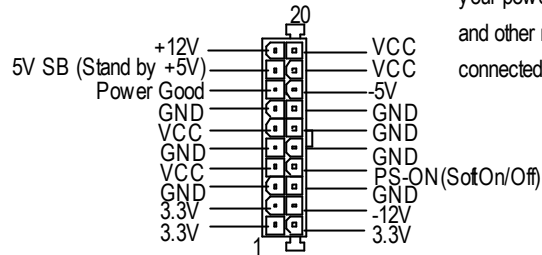

⚠ AC power cord should only be connected to your power supply unit after ATX power cable and other related devices are firmly connected to the mainboard.

**J) F\_USB (Front USB Connector)**

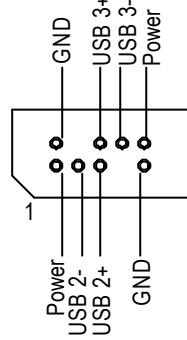

⚠ Be careful with the polarity of the front panel USB connector. Check the pin assignment while you connect the front panel USB cable. Please contact your nearest dealer for optional front panel USB cable.

**F) IR**

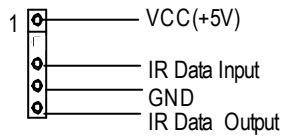

⚠ Be careful with the polarity of the IR connector while you connect the IR. Please contact you nearest dealer for optional IR device.

**K) Battery**

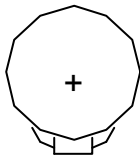

**CAUTION**

- ⚠ Danger of explosion if battery is incorrectly replaced.
- ⚠ Replace only with the same or equivalent type recommended by the manufacturer.
- ⚠ Dispose of used batteries according to the manufacturer's instructions.

I) F\_PANEL (2x7 pins jumper)

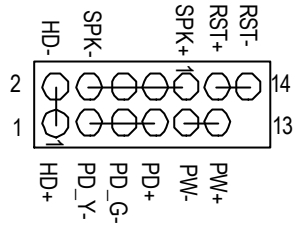

HD (IDE Hard Disk Active LED)	Pin 1: LED anode(+) Pin 2: LED cathode(-)
SPK (Speaker Connector)	Pin 1: VCC(+) Pin 2- Pin 3: NC Pin 4: Data(-)
RST (Reset Switch)	Open: Normal Operation Close: Reset Hardware System
PD+/PD_G-/PD_Y-(Power LED)	Pin 1: LED anode(+) Pin 2: LED cathode(-) Pin 3: LED cathode(-)
PW (Soft Power Connector)	Open: Normal Operation Close: Power On/Off

⚠ Please connect the power LED, PC speaker, reset switch and power switch etc of your chassis front panel to the F\_PANEL connector according to the pin assignment above.



## Chapter 3 BIOS Setup

BIOS Setup is an overview of the BIOS Setup Program. The program that allows users to modify the basic system configuration. This type of information is stored in battery-backed CMOS RAM so that it retains the Setup information when the power is turned off.

### ENTERING SETUP

Power ON the computer and press <Del> immediately will allow you to enter Setup. If the message disappears before you respond and you still wish to enter Setup, restart the system to try again by turning it OFF then ON or pressing the "RESET" button on the system case. You may also restart by simultaneously press <Ctrl> - <Alt>- <Del> keys.

### CONTROL KEYS

<Left>	Move to previous item
<Right>	Move to next item
<Left>	Move to the item in the left hand
<Right>	Move to the item in the right hand
<Esc>	Main Menu - Quit and not save changes into CMOS Status Page Setup Menu and Option Page Setup Menu - Exit current page and return to Main Menu
<+/PgUp>	Increase the numeric value or make changes
<-/PgDn>	Decrease the numeric value or make changes
<F1>	General help, only for Status Page Setup Menu and Option Page Setup Menu
<F2>	Reserved
<F3>	Reserved
<F4>	Reserved
<F5>	Restore the previous CMOS value from CMOS, only for Option Page Setup Menu
<F6>	Load the default CMOS value from BIOS default table, only for Option Page Setup Menu
<F7>	Load the Setup Defaults
<F8>	Reserved
<F9>	Reserved
<F10>	Save all the CMOS changes, only for Main Menu

**GETTING HELP**

**Main Menu**

The on-line description of the highlighted setup function is displayed at the bottom of the screen.

**Status Page Setup Menu / Option Page Setup Menu**

Press F1 to pop up a small help window that describes the appropriate keys to use and the possible selections for the highlighted item. To exit the Help Window press <Esc>.

**Q-Flash Utility**

After power on the computer, pressing <Del> immediately during POST (Power On Self Test) it will allow you to enter AMI BIOS CMOS SETUP, then press <F8> to enter Q-Flash utility.

**The Main Menu (For example: BIOS Ver. : F1)**

Once you enter AMI BIOS CMOS Setup Utility, the Main Menu (Figure 1) will appear on the screen. The Main Menu allows you to select from eight setup functions and two exit choices. Use arrow keys to select among the items and press <Enter> to accept or enter the sub-menu.

AMIBIOS SIMPLE SETUP UTILITY - VERSION 2.00 (C) 2001 American Megatrends, Inc. All Rights Reserved	
STANDARD CMOS SETUP	INTEGRATED PERIPHERALS
BIOS FEATURES SETUP	HARDWARE MONITOR & MISC SETUP
CHIPSET FEATURES SETUP	SUPERVISOR PASSWORD
POWER MANAGEMENT SETUP	USER PASSWORD
PNP / PCI CONFIGURATION	HDD AUTO DETECTION
LOAD FAIL-SAFE DEFAULTS	SAVE & EXIT SETUP
LOAD OPTIMIZED DEFAULT	EXIT WITHOUT SAVING
ESC: Quit	↑↑↑↑↑: Select Item
F7: Optimized Values	F5: Old Values
	F6: Fail-Safe Values
	F8: Q-Flash Utility
	F10: Save & Exit
Time, Date, Hard Disk Type...	

Figure 1: Main Menu

☞ **Standard CMOS Features**

This setup page includes all the items in standard compatible BIOS.

☞ **BIOS Features Setup**

This setup page includes all the adjustable items of AMI special enhanced features.

☞ **Chipset Features Setup**

This setup page includes all the adjustable items of chipset special features.

☞ **Power Management Setup**

This setup page includes all the adjustable items of Green function features.

☞ **PNP/PCI Configurations**

This setup page includes all the adjustable configurations of PCI & PnP ISA resources.

☞ **Load Fail-Safe Defaults**

Load Fail-Safe Defaults option loads preset system parameter values to set the system in its most stable configurations.

☞ **Load Optimized Defaults**

Load Optimized Defaults option loads preset system parameter values to set the system in its highest performance configurations.

☞ **Integrated Peripherals**

This setup page includes all onboard peripherals.

☞ **Hardware Monitor & MIS C Setup**

This setup page is auto detect fan and temperature status.

☞ **Set Supervisor password**

Set Change or disable password. It allows you to limit access to the system and/or BIOS setup.

☞ **Set User password**

Set Change or disable password. It allows you to limit access to the system.

☞ **IDE HDD Auto Detection**

Automatically configure hard disk parameters.

☞ **Save & Exit Setup**

Save CMOS value settings to CMOS and exit setup.

☞ **Exit Without Saving**

Abandon all CMOS value changes and exit setup.

AMIBIOS SETUP - STANDARD CMOS SETUP

( C ) 2001 American Megatrends, Inc. All Rights Reserved

System Date :Jan 03 2002 Thu

System Time : 09:52:45

TYPE SIZE CYLS HEAD PRECOMP LANDZ SECTOR MODE

Pri Master : Auto

Pri Slave : Auto

Sec Master : Auto

Sec Slave : Auto

Floppy Drive A : 1.44 MB 3<sup>1/2</sup> Base Memory : 640 Kb BIOS Setup

Floppy Drive B : Not Installed Other Memory : 384 Kb

Extended Memory : 127 Mb

Virus Protection : Disabled Total Memory : 256 Mb

Date is standard Format ESC : Exit

Month : Jan - Dec 777 - Select Item





Day : 01- 31 PU / PD / + / - :Modify

Year : 1990 - 2099 (Shift) F2 : Color

Figure 2: Standard CMOS Setup

 **Date**

The date format is <month>, <day>, <year>, <week>.

-  **Month** The month, Jan. Through Dec.
-  **Day** The day, from 1 to 31 (or the maximum allowed in the month)
-  **Year** The year, from 1990 through 2099
-  **Week** The week, from Sun to Sat, determined by the BIOS and is display only

☞ **Time**

The times format in <hour> <minute> <second>. The time is calculated base on the 24-hour military-time clock. For example, 1 p.m. is 13:00:00.

☞ **Primary Master, Slave / Secondary Master, Slave**

The category identifies the types of hard disk from drive C to F that has been installed in the computer. There are two types: auto type, and manual type. Manual type is user-definable; Auto type which will automatically detect HDD type.

Note that the specifications of your drive must match with the drive table. The hard disk will not work properly if you enter improper information for this category.

If you select User Type, related information will be asked to enter to the following items. Enter the information directly from the keyboard and press <Enter>. Such information should be provided in the documentation from your hard disk vendor or the system manufacturer.

- ☞ CYLS.            Number of cylinders
- ☞ HEADS           number of heads
- ☞ PRECOMP       write precomp
- ☞ LANDZONE      Landing zone
- ☞ SECTORS        number of sectors

If a hard disk has not been installed select NONE and press <Enter>.

☞ **Floppy Drive A / Drive B**

The category identifies the types of floppy disk drive A or drive B that has been installed in the computer.

- ☞ None            No floppy drive installed
- ☞ 360K, 5.25 in.   5.25 inch PC-type standard drive; 360K byte capacity.
- ☞ 1.2M, 5.25 in.   5.25 inch AT-type high-density drive; 1.2M byte capacity  
(3.5 inch when 3 Mode is Enabled).
- ☞ 720K, 3.5 in.    3.5 inch double-sided drive; 720K byte capacity
- ☞ 1.44M, 3.5 in.   3.5 inch double-sided drive; 1.44M byte capacity.
- ☞ 2.88M, 3.5 in.   3.5 inch double-sided drive; 2.88M byte capacity.

### **Boot Sector Virus Protection**

If it is set to enable, the category will flash on the screen when there is any attempt to write to the boot sector or partition table of the hard disk drive. The system will halt and the following error message will appear in the mean time. You can run anti-virus program to locate the problem.

- Enabled     Activate automatically when the system boots up causing a warning message to appear when anything attempts to access the boot sector or hard disk partition table
  
- Disabled     No warning message to appear when anything attempts to access the boot sector or hard disk partition table (Default Value)

### **Memory**

The category is display-only which is determined by POST (Power On Self Test) of the BIOS.

#### **Base Memory**

The POST of the BIOS will determine the amount of base (or conventional) memory installed in the system.

The value of the base memory is typically 512 K for systems with 512 K memory installed on the motherboard, or 640 K for systems with 640 K or more memory installed on the motherboard.

#### **Other Memory**

This refers to the memory located in the 640 K to 1024 K address space. This is memory that can be used for different applications.

DOS uses this area to load device drivers to keep as much base memory free for application programs. Most use for this area is Shadow RAM.

#### **Extended Memory**

The BIOS determines how much extended memory is present during the POST.

This is the amount of memory located above 1 MB in the CPU's memory address map.

## BIOS Features Setup

AMIBIOS SETUP - BIOS FEATURES SETUP	
( C ) 2001 American Megatrends, Inc. All Rights Reserved	
BIOS Flash Protection	: Auto
1st Boot Device	: Floppy
2nd Boot Device	: IDE-0
3rd Boot Device	: CDROM
Floppy Drive Seek	: Disabled
BootUp Num-Lock	: On
Password Check	: Setup
S.M.A.R.T. for Hard Disks	: Disabled
Interrupt Mode	:APIC
ESC: Quit    ↓↓↓↓ : Select Item F1 : Help    PU/PD+/- : Modify F5 : Old Values (Shift)F2: Color F6 : Fail-Safe    F7 : Optimized F8 : Q-Flash Utility	

Figure 3: BIOS Features Setup





### BIOS Flash Protection

This field lets you determine the states that flash BIOS

- Auto            BIOS enables flash write access automatically when updating BIOS data/DMI/ESCD. (Default Value)
- Enabled            During POST, DMI/ESCD would not be updated. But flash tools can update BIOS always.



### 1st / 2nd / 3rd Boot device

- Floppy            Select your boot device priority by Floppy.
- CDROM            Select your boot device priority by CDROM.
- SCSI                Select your boot device priority by SCSI.
- NETWORK            Select your boot device priority by NETWORK.
- Disabled            Disable this function.
- IDE-0~3            Select your boot device priority by IDE-0~3.
- USB RMD-HDD        Select your boot device priority by USB RMD-HDD.
- USB RMD-FDD        Select your boot device priority by USB RMD-FDD.
- USB HDD            Select your boot device priority by USB HDD.
- USB FDD            Select your boot device priority by USB FDD.



-  USB CDROM Select your boot device priority by USB CDROM.
-  BBS1~3 Select your boot device priority by BIOS Boot Specification 1~3.
-  Realtek Boot Select your boot device priority by onboard lan (Realtek).
-  ARMD FDD Select your boot device priority by ARMD FDD.
-  ARMD HDD Select your boot device priority by ARMD HDD.

### Floppy Drive Seek

During POST, BIOS will determine the floppy disk drive installed is 40 or 80 tracks. 360 K type is 40 tracks 720 K, 1.2 M and 1.44 M are all 80 tracks.



-  Enabled BIOS searches for floppy disk drive to determine it is 40 or 80 tracks. Note that BIOS can not tell from 720 K, 1.2 M or 1.44 M drive type as they are all 80tracks.
-  Disabled BIOS will not search for the type of floppy disk drive by track number. Note that there will not be any warning message if the drive installed is 360 K. (Default value)

### Boot Up NumLock



-  On Keypad is number keys. (Default value)
-  Off Keypad is arrow keys.

### Password Check



Please refer to the detail on P.48

-  Always The user must enter correct password in order to access the system and/or BIOS Setup.
-  Setup The user must enter correct password in order to access BIOS setup utility. (Default Value)

### HDD S.M.A.R.T Capability

-  Enabled Enable HDD S.M.A.R.T. Capability.
-  Disabled Disable HDD S.M.A.R.T. Capability. (Default value)

### Interrupt Mode

-  APIC Through IOAPIC generate more IRQ for system use.(Default value)
-  PIC Use AT standard IRQ controlles to generate IRQ.

When you already have IOAPIC enable system and want to upgrade the system please note, since running an IOAPIC enabled OS (like Windows NT, Windows 2000, Windows XP...) system with none IOAPIC HW support will cause the system to hang. Following are some situations users might run into:

- 1.An IOAPIC enabled OS and change the BIOS setting from IOAPIC to PIC, this will cause your system to hang.



## Chipset Features Setup

AMBIOS SETUP - CHIPSET FEATURES SETUP	
( C ) 2001 American Megatrends, Inc. All Rights Reserved	
Linear Frequency Control	: Disabled
***CPU/DRAM Base Frequency	: H/W TRAP
⌘ CPU Frequency	: N/A
⌘ DRAM Frequency	: N/A
⌘ AGP Frequency	: N/A
⌘ PCI Frequency	: N/A
⌘ ZCLK Frequency	: N/A
CPU Frequency Ratio	: 14.0x
Vcra Voltage	: Original
Share Memory Size	: 32MB
TV NTSC/PAL Select	: NTSC
Graphic Win Size	: 64MB
DRAM CAS# Latency	: 3T
Timing Setting Mode	: Normal
MA 1T/2T Select	: Auto
ESC: Quit    ↓ ↑ ← →: Select Item F1 : Help    PU/PD+/- : Modify F5 : Old Values (Shift)F2: Color F6 : Fail-Safe    F7: Optimized F8 : Q-flash Utility	

Figure 4: Chipset Features Setup

\*\*\*This item will be available when "Linear Frequency Control" is set to Disabled.

⌘ Those items will be available when "Linear Frequency Control" is set to Enabled.

### ⌘ Linear Frequency Control

When set to "Enabled", you can adjust CPU / DRAM / AGP / PCI / ZCLK linear frequency. For powerEnd-User use only.

- 🔘 Enabled      Enabled linear frequency control.
- 🔘 Disabled     Disabled linear frequency control. (Default Value)

### ⌘ CPU/DRAM Base Frequency (MHz)

When set to "H/W TRAP", the CPU/DRAM base frequency will be depend on Original design. You may also set FSB clock by BIOS. For power End-User use only.

🔑 H/W TRAP	Set CPU /DRAM Base frequency (MHz) to By Hardware. (Default Value)
🔑 66/66 MHz	Set CPU /DRAM Base frequency (MHz) to 66/66MHz
🔑 100/100 MHz	Set CPU /DRAM Base frequency (MHz) to 100/100MHz
🔑 100/133 MHz	Set CPU /DRAM Base frequency (MHz) to 100/133MHz
🔑 100/166 MHz	Set CPU /DRAM Base frequency (MHz) to 100/166MHz
🔑 100/200 MHz	Set CPU /DRAM Base frequency (MHz) to 100/200MHz
🔑 133/100 MHz	Set CPU /DRAM Base frequency (MHz) to 133/100MHz
🔑 133/133 MHz	Set CPU /DRAM Base frequency (MHz) to 133/133MHz
🔑 133/166 MHz	Set CPU /DRAM Base frequency (MHz) to 133/166MHz

### ⌘ CPU Frequency

This feature allows you to adjust the CPU frequency, When "Linear Frequency Control" is set to Enabled.

🔑 CPU frequency value(200-100, default :100)

### ⌘ DRAM Frequency

This feature allows you to adjust the DRAM frequency, When "Linear Frequency Control" is set to Enabled.

🔑 Optionals will be changed according to "CPU frequency" value. (DRAM Frequency value100, 133,200,default:133) This is for CPU Frequency =100.

### ⌘ AGP Frequency

This feature allows you to adjust the AGP frequency, When "Linear Frequency Control" is set to Enabled.

🔑 Optionals will be changed according to "CPU frequency" value. (AGP frequency value50,66, 57,80, default :57)This is for CPU Frequency =100.

### ⌘ **PCI Frequency**

This feature allows you to adjust the PCI frequency, When "Linear Frequency Control" is set to Enabled.

☛ Optionals will be changed according to "CPU frequency" value. (PCI frequency value 33,40, default :33) This is for CPU Frequency =100.

### ⌘ **ZCLK Frequency**

This feature allows you to adjust the ZCLK frequency, When "Linear Frequency Control" is set to Enabled.

☛ Optionals will be changed according to "CPU frequency" value. (ZCLK frequency value 50,66, 57,80, default :66) This is for CPU Frequency =100.

### ⌘ **CPU Frequency Ratio**

Set CPU Ratio if CPU Ratio is unlocked.

☛ X8-X 24                      It's depends on CPU Clock Ratio.

### ⌘ **Vcore Voltage**

- ☛ Original      Original Vcore Voltage. (Default Value)
- ☛ +0.025V      Original Vcore Voltage +0.025V.
- ☛ +0.050V      Original Vcore Voltage +0.050V.
- ☛ +0.075V      Original Vcore Voltage +0.075V.
- ☛ +0.100V      Original Vcore Voltage +0.100V.

### ⌘ **Share Memory Size**

☛ Set onchip VGA memory size.

### ⌘ **TV NTSC/PAL Select**

☛ Set TV system for TV out option.

---

**Graphics Win Size**

- 4 MB      Display Graphics Aperture Size is 4MB.
- 8 MB      Display Graphics Aperture Size is 8MB.
- 16 MB     Display Graphics Aperture Size is 16MB.
- 32 MB     Display Graphics Aperture Size is 32MB.
- 64 MB     Display Graphics Aperture Size is 64MB. (Default Value)
- 128 MB    Display Graphics Aperture Size is 128MB.
- 256 MB    Display Graphics Aperture Size is 256MB.

**DRAM CAS# latency**

This feature allows you to select the CAS latency Time, When any DDR DIMM installed.

- 2T      Set CAS latency Time is 2. (Default Value)
- 3T      Set CAS latency Time is 3.

**Timing Setting Mode**

- Set system timing mode.

**MA 1T/2T Select**



- 1T      memory read /w rite or background command and MA are issued at the same time.
- 2T      memory read /w rite or background command are issued 1 clock behind memory address (MA).
- Auto    auto assign.(Default Value)

## Power Management Setup



AMIBIOS SETUP - POWER MANAGEMENT SETUP ( C ) 2001 American Megatrends, Inc. All Rights Reserved	
ACPI Sleep Type	: S1
Suspend Time Out (Minute)	: Disabled
Soft-Off by Power Button	: Instant Off
System After AC Back	: Power Off
ModemRingOn	: Enabled
PME Event Wake Up	: Enabled
Resume On RTC Alarm	: Disabled
RTC Alarm Date	: Event Day
RTC Alarm Hour	: 12
RTC Alarm Minute	: 30
RTC Alarm Second	: 00
ESC: Quit    ↓↑←→: Select Item F1 : Help    PU/PD+/- : Modify F5 : Old Values (Shift)F2: Color F6 : Fail-Safe    F7: Optimized F8 : Q-flash Utility	

Figure 5: Power Management Setup

### ACPI Sleep Type

-  S1      Set ACPI Sleep Type to S1/POS (Power On Suspend). (Default value)
-  S3      Set ACPI Sleep Type to S3/STR (Suspend To RAM).

### Suspend Time Out

-  Disabled      Disable the timer to enter suspend mode. (Default Value)
-  1Minute ~ 60 Minute      Set the timer to enter suspend mode.

---

### ⌘ Soft-off by Power Button

- ⌘ Instant off     The user press the power button once, he can turn off the system.  
(Default Value)
- ⌘ Suspend        The user press the power button once, then he can enter suspend mode.

### ⌘ System after AC Back

- ⌘ Power Off      When AC-power back to the system, the system will be in "Off" state.  
(Default Value)
- ⌘ Power On        When AC-power back to the system, the system will be in "On" state.
- ⌘ Last State      When AC-power back to the system, the system will return to the Last  
state before AC-power off.

### ⌘ ModemRingOn

- ⌘ Disabled        Disable Modem Ring On function.
- ⌘ Enabled         The modem ring wake up will bring the system out of soft-off or suspend  
state if this option is set "Enabled". (Default Value)

### ⌘ PME Event Wake up

- ⌘ Disabled        Disable PME event wake up function.
- ⌘ Enabled         The PME event wake up will bring the system out of soft-off or suspend  
state if this option is set "Enabled". (Default Value)

### ⌘ Resume On RTC Alarm

You can set "Resume On RTC Alarm " item to enabled and key in Data/time to power on system.

- ⌘ Disabled        Disable this function. (Default Value)
- ⌘ Enabled         Enable alarm function to POWER ON system.

If Resume by RTC Alarm is Enabled.

- ⌘ RTC Alarm Date:     Every Day, 1~31
- ⌘ RTC Alarm Hour:     0~23
- ⌘ RTC Alarm Minute:   0~59
- ⌘ RTC Alarm Second:   0~59

## PNP/PCI Configuration

AMIBIOS SETUP - PNP/PCI CONFIGURATION	
( C ) 2001 American Megatrends, Inc. All Rights Reserved	
VGA Boot From : Auto	
PCI Slot 1 IRQ Priority : Auto	
PCI Slot 2 IRQ Priority : Auto	
PCI Slot 3 IRQ Priority : Auto	
	ESC: Quit    ↓↓↓↓: Select Item
	F1 : Help    PU/PD+/- : Modify
	F5 : Old Values (Shift)F2: Color
	F6 : Fail-Safe    F7: Optimized
	F8 : Q-Flash Utility









Figure 6: PNP/PCI Configuration

### 🔍 VGA Boot From

- 🖥️ Internal      Set VGA Boot from onborad AGP Card.
- 🖥️ Ex ternal AGP      Set VGA Boot from Ex ternal AGP Card.
- 🖥️ Ex ternal PCI      Set VGA Boot from Ex ternal PCI Card.
- 🖥️ Auto      Detect VGA boot automatically.(Default Value)

---

**PCI Slot 1, 2, 3 IRQ Priority**

-  Auto      The system will reserved a free IRQ for PCI slot 1, 2, 3 device.  
(Default Value)
-  3      The system will reserved IRQ3 for PCI slot 1, 2, 3 device if no legacy ISA device using IRQ3.
-  4      The system will reserved IRQ for PCI slot 1, 2, 3 device if no legacy ISA device using IRQ4.
-  5      The system will reserved IRQ5 for PCI slot 1, 2, 3 device if no legacy ISA device using IRQ5.
-  7      The system will reserved IRQ7 for PCI slot 1, 2, 3 device if no legacy ISA device using IRQ7.
-  9      The system will reserved IRQ9 for PCI slot 1, 2, 3 device if no legacy ISA device using IRQ9.
-  10      The system will reserved IRQ10 for PCI slot 1, 2, 3 device if no legacy ISA device using IRQ10.
-  11      The system will reserved IRQ11 for PCI slot 1, 2, 3 device if no legacy ISA device using IRQ11.



## Load Fail-Safe Defaults

AMIBIOS SIMPLE SETUP UTILITY - VERSION 2.00 (C) 2001 American Megatrends, Inc. All Rights Reserved	
STANDARD CMOS SETUP	INTEGRATED PERIPHERALS
BIOS FEATURES SETUP	HARDWARE MONITOR & MISC SETUP
CHIPSET FEATURES SETUP	SUPERVISOR PASSWORD
POWER MANAGEMENT SETUP	LOAD FAIL-SAFE DEFAULTS
PNP / PCI CONFIGURATION	SAVE & EXIT SETUP
LOAD FAIL-SAFE DEFAULTS	EXIT WITHOUT SAVING
LOAD OPTIMIZED DEFAULTS	
EESC: Quit    ↓ ↓ ↓ ↓ ↓ : Select Item    F5: Old Values    F6: Fail-Safe Values	
F7: Optimized Values    F8: Q-Flash Utility    F10: Save & Exit	
Load Fail-Safe Defaults except Standard CMOS SETUP	

Figure 7: Load Fail-Safe Defaults

### Load Fail-Safe Defaults

Fail-Safe defaults contain the most appropriate system parameter values of to configure the system to achieve maximum stability.

## Load Optimized Defaults

AMIBIOS SIMPLE SETUP UTILITY - VERSION 2.00 (C) 2001 American Megatrends, Inc. All Rights Reserved	
STANDARD CMOS SETUP	INTEGRATED PERIPHERALS
BIOS FEATURES SETUP	HARDWARE MONITOR & MISC SETUP
CHIPSET FEATURES SETUP	SUPERVISOR PASSWORD
POWER MANAGEMENT SETUP	LOAD OPTIMIZED
PNP / PCI CONFIGURATION	Load Optimized Defaults? (Y/N)?N
LOAD FAIL-SAFE DEFAULTS	SAVE & EXIT SETUP
LOAD OPTIMIZED DEFAULTS	EXIT WITHOUT SAVING
ESC: Quit    ↓ ↓ ↓ ↓ ↓ : Select Item    F5: Old Values    F6: Fail-Safe Values F7: Optimized Values    F8: Q-Flash Utility    F10: Save & Exit	
Load Optimized Defaults except Standard CMOS SETUP	

Figure 8: Load Optimized Defaults

### Load Optimized Defaults

Optimized defaults contain the most appropriate system parameter values to configure the system to achieve maximum performance.

## Integrated Peripherals

AMIBIOS SETUP - INTEGRATED PERIPHERALS			
( C ) 2001 American Megatrends, Inc. All Rights Reserved			
OnBoard IDE	: Both	Modem Device	: Auto
IDE 1 Conductor Cable	: Auto	Onboard LAN	: Enabled
IDE 2 Conductor Cable	: Auto	Mouse PowerOn Function	: Disabled
OnBoard FDC	: Auto	Keyboard PowerOn Function	: Disabled
OnBoard Serial Port A	: Auto	Specific Key for PowerOn	: N/A
OnBoard Serial Port B	: Auto		
Serial Port B Mode	: Normal		
OnBoard Parallel Port	: Auto		
Parallel Port Mode	: ECP		
EPP Version	: N/A		
Parallel Port IRQ	: Auto		
Parallel Port DMA	: Auto		
OnBoard Midi Port	: 330h		
Midi IRQ Select	: 5		
OnBoard Game Port	: 200h		
USB Function	: Both	ESC: Quit	↓ ↓ ↓ ↓ ↓ : Select Item
USB Controller 0	: Port 1+2	F1 : Help	PU/PD+/- : Modify
USB Controller1	: Port 1+2	F5 : Old Values (Shift)	F2: Color
USB Legacy Support	: Disabled	F6 : Fail-Safe	F7:Optimized
Audio Device	: Auto	F8 : Q-Flash Utility	

Figure 9: Integrated Peripherals

---

### OnBoard IDE

- ☒ Disabled      Disable OnBoard IDE.
- ☒ Both          Both Primary & Secondary IDE channel will be enabled. (Default Value)
- ☒ Primary      Only Primary IDE channel is enabled.
- ☒ Secondary    Only Secondary IDE channel is enabled.

### IDE1 Conductor Cable

- ☒ Auto          Will be automatically detected by BIOS (Default Value)
- ☒ ATA66/100    Set IDE1 Conductor Cable to ATA66/100 (Please make sure your IDE device and cable is compatible with ATA66/100)
- ☒ ATA33        Set IDE1 Conductor Cable to ATA33 (Please make sure your IDE device and cable is compatible with ATA33).

### IDE2 Conductor Cable

- ☒ Auto          Will be automatically detected by BIOS (Default Value)
- ☒ ATA66/100    Set IDE2 Conductor Cable to ATA66/100 (Please make sure your IDE device and cable is compatible with ATA66/100)
- ☒ ATA33        Set IDE2 Conductor Cable to ATA33 (Please make sure your IDE device and cable is compatible with ATA33).

### OnBoard FDC

- ☒ Disabled      Disable this function.
- ☒ Enabled        Enable on board floppy disk controller.
- ☒ Auto          Set the floppy disk controller automatically. (Default Value)

### Onboard Serial Port A

- ☒ Auto          BIOS will automatically setup the port A address. (Default Value)
- ☒ 3F8/COM1     Enable onboard Serial port A and address is 3F8.
- ☒ 2F8/COM2     Enable onboard Serial port A and address is 2F8.
- ☒ 3E8/COM3     Enable onboard Serial port A and address is 3E8.
- ☒ 2E8/COM4     Enable onboard Serial port A and address is 2E8.
- ☒ Disabled      Disable onboard Serial port A.

### ☞ Onboard Serial Port B

- ☞ Auto BIOS will automatically setup the port B address. (Default Value)
- ☞ 3F8/COM1 Enable onboard Serial port B and address is 3F8.
- ☞ 2F8/COM2 Enable onboard Serial port B and address is 2F8.
- ☞ 3E8/COM3 Enable onboard Serial port B and address is 3E8.
- ☞ 2E8/COM4 Enable onboard Serial port B and address is 2E8.
- ☞ Disabled Disable onboard Serial port B.

### ☞ Serial Port B Mode

(This item allows you to determine which Infra Red(IR) function of Onboard I/O chip)

- ☞ ASKIR Set onboard I/O chip UART to ASKIR Mode.
- ☞ IrDa Set onboard I/O chip UART to IrDa Mode.
- ☞ Normal Set onboard I/O chip UART to Normal Mode. (Default Value)

### ☞ Onboard Parallel Port

- ☞ 378h Set On Board LPT port and address to 378.
- ☞ 278h Set On Board LPT port and address to 278.
- ☞ 3BCh Set On Board LPT port and address to 3BC.
- ☞ Auto Set On Board LPT port Automatically. (Default Value)
- ☞ Disabled Disable onboard Serial port A.

### ☞ Parallel Port Mode

- ☞ EPP Using Parallel port as Enhanced Parallel Port.
- ☞ ECP Using Parallel port as Extended Capabilities Port. (Default Value)
- ☞ Normal Normal Operation.
- ☞ Bi-Dir Set Bi-direction mode.

### ☞ EPP Version

- ☞ N/A Disable this function. (Default Value)
- ☞ EPP 1.9 Compliant with EPP 1.9 version.
- ☞ EPP 1.7 Compliant with EPP 1.7 version.

---

**Parallel Port IRQ**

- 7 Set Parallel Port IRQ to 7.
- 5 Set Parallel Port IRQ to 5.
- Auto Set Parallel Port IRQ automatically. (Default Value)

**Parallel Port DMA**

- 3 Set Parallel Port DMA to 3.
- 1 Set Parallel Port DMA to 1.
- 0 Set Parallel Port DMA to 0.
- Auto Set Parallel Port DMA automatically. (Default Value)

**OnBoard Midi Port**

- Disabled Disable onboard Midi Port.
- 300h Set onboard Midi Port to 300h.
- 330h Set onboard Midi Port to 330h. (Default Value)
- 292h Set onboard Midi Port to 292h.
- 290h Set onboard Midi Port to 290h.

**Midi IRQ Select**

- IRQ 5 / 11 / 10 (Default Value:5)

**OnBoard Game Port**

- Disabled Disable OnBoard Game Port.
- 200h Set OnBoard Game Port to 200h. (Default Value)
- 208h Set OnBoard Game Port to 208h.

**USB Function**

- Controller 0 Enabled USB Controller 0.
- Controller 1 Enabled USB Controller 1.
- Disabled Disabled USB Controller.
- Both Enabled USB Controller 0. and 1 (Default value)

**USB Controller 0**

- Port 1 Enable Port 1 inside USB controller 0.
- Port1+2 Enable Port 1and 2 inside USB controller 0.(Default v value)

**USB Controller 1**

- Port 1 Enable Port 1 inside USB controller 1.
- Port1+2 Enable Port 1and 2 inside USB controller 1.(Default v value)

**USB Legacy Support**

- Enabled Enable USB Legacy Support.
- Disabled Disable this function.(Default Value)

**Audio Device**

- Auto BIOS will search AC97 Codec (CNR Modem Card). If found, AC97 function will be enabled. If no AC97 Codec found, AC97 function will be disabled. (Default Value).
- Enabled Force to enable AC'97 audio function.
- Disabled Disable this function.

**Modem Device**

- Auto BIOS will search MC97 Codec (CNR Modem Card). If found, MC97 function will be enabled. If no MC97 Codec found, MC97 function will be disabled. (Default Value)
- Enabled Force to enable MC'97 even codec is not detected.
- Disabled Disable this function.

**Onboard Lan**

- Disabled Disable this function.
- Enabled Enable Onboard Lan Chip function. (Default Value)

**Mouse Power On Function**

- Disabled Disable this function. (Default Value)
- Enabled Click button to power on the system.

**Keyboard PowerOn Function**

- ⌘ Disabled      Disable this function. (Default Value)
- ⌘ Specific key    Set password key to power on by keyboard.
- ⌘ Any Key        Set any key to power on the system.

**Specific Key for PowerOn**

- ⌘ N/A            Disable this function. (Default Value)
- ⌘ Password ↵    Input password (from 1 to 5 characters) and press Enter to set the Keyboard Power On Password.



## Hardware Monitor & MISC Setup

AMIBIOS SETUP - HARDWARE MONITOR & MISC SETUP	
( C ) 2001 American Megatrends, Inc. All Rights Reserved	
CPU Temp. Alarm	:Disabled
CPU Fan Fail Alarm	:No
System Fan Fail Alarm	:No
Reset Case Open Status	:No
Case Status	:Opened
Current CPU Temp.	: 34°C/ 93°F
Current System Temp.	: 28°C/ 82°F
Current CPU Fan Speed	: 5273 RPM
Current System Fan Speed	: 0 RPM
Vcore	: 1.712V
Vcc3	: 3.296V
Vcc	: 4.999V
+12V	: 11.815V
Battery	: 3.200V
ESC: Quit    ↓↓↓↓ : Select Item F1 : Help    PU/PD+/- : Modify F5 : Old Values (Shift)F2: Color F6 : Fail-Safe    F7 : Optimized F8 : Q-flash Utility	

Figure 10: Hardware Monitor & MISC Setup

### ☞ CPU Temp. Alarm

- ☞ 60°C / 140°F    Monitor CPU Temp. at 60°C / 140°F.
- ☞ 70°C / 158°F    Monitor CPU Temp. at 70°C / 158°F.
- ☞ 80°C / 176°F    Monitor CPU Temp. at 80°C / 176°F.
- ☞ 90°C / 194°F    Monitor CPU Temp. at 90°C / 194°F.
- ☞ Disabled        Disable this function. (Default Value)

---

**Fan Fail Alarm**

CPU/ System

- No Fan Fail Alarm Function Disable. (Default Value)
- Yes Fan Fail Alarm Function Enable.

**Reset Case Open Status****Case Status**

If the case is closed, "Case Status" will show "Closed".

If the case have been opened, "Case Status" will show "Opened".

If you want to reset "Case Status" value, set "Reset Case Open Status" to "Yes" and save CMOS, your computer will restart.

**Current CPU Temp.**

- Detect CPU Temp. automatically.

**Current System Temp.**

- Detect System Temp. automatically.

**Current CPU Fan / System Fan Fan Speed (RPM)**

- Detect Fan speed status automatically.

**Current Vcore / Vcc3 / Vcc / +12 / Battery**

- Detect system's voltage status automatically.

## Set Supervisor / User Password

When you select this function, the following message will appear at the center of the screen to assist you in creating a password.

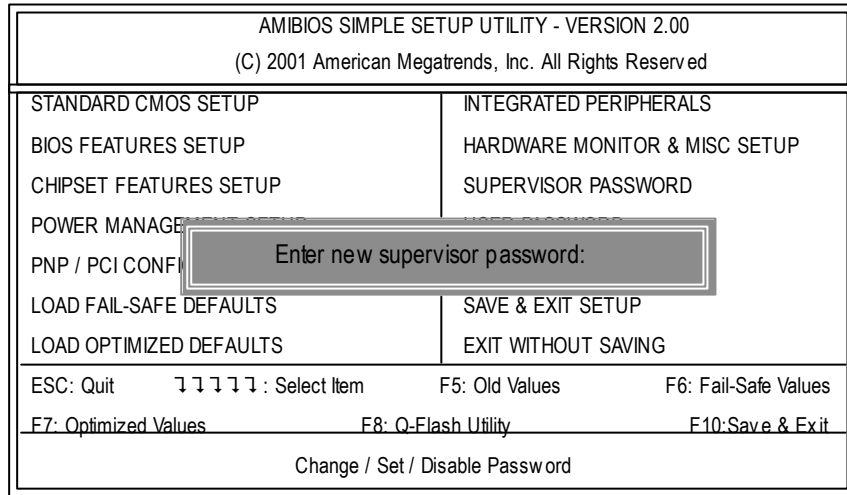

Figure 11: Password Setting

Type the password, up to six characters, and press <Enter>. You will be asked to confirm the password. Type the password again and press <Enter>. You may also press <Esc> to abort the selection and not enter a password.

To disable password, just press <Enter> when you are prompted to enter password. A message "PASSWORD DISABLED" will appear to confirm the password being disabled. Once the password is disabled, the system will boot and you can enter Setup freely.

The BIOS Setup program allows you to specify two separate passwords: a SUPERVISOR PASSWORD and a USER PASSWORD. When disabled, anyone may access all BIOS Setup program function. When enabled, the Supervisor password is required for entering the BIOS Setup program and having full configuration fields, the User password is required to access only basic items.

If you select "Always" at "Password Check" in BIOS Features Setup Menu, you will be prompted for the password every time the system is rebooted or any time you try to enter Setup Menu.

If you select "Setup" at "Password Check" in BIOS Features Setup Menu, you will be prompted only when you try to enter Setup.

## IDE HDD Auto Detection

AMIBIOS SETUP - STANDARD CMOS SETUP	
( C ) 2001 American Megatrends, Inc. All Rights Reserved	
System Date	:Jan 03 2002 Thu
System Time	: 09:52:45
	TYPE SIZE CYLS HEAD PRECOMP LANDZ SECTOR MODE
Pri Master	: Auto
Pri Slave	: Auto
Sec Master	: Auto
Sec Slave	: Auto
Floppy Drive A	: 1.44 MB 3 <sup>1/2</sup>
Floppy Drive B	: Not Installed
Virus Protection	: Disabled
Date is standard Format	ESC : Exit
Month : Jan - Dec	↓↑↓ : Select Item
Day : 01- 31	PU / PD / + / - :Modify
Year : 1990 - 2099	(Shift) F2 : Color
	Base Memory : 640 Kb
	Other Memory : 384 Kb
	Extended Memory : 255 Mb
	Total Memory : 256 Mb

Figure 12: IDE HDD Auto Detection

Type "Y" will accept the H.D.D. parameter reported by BIOS.

Type "N" will keep the old H.D.D. parameter setup. If the hard disk cylinder number is over 1024, then the user can select LBA mode or LARGER mode for DOS partition larger than 528 MB.

## Save & Exit Setup

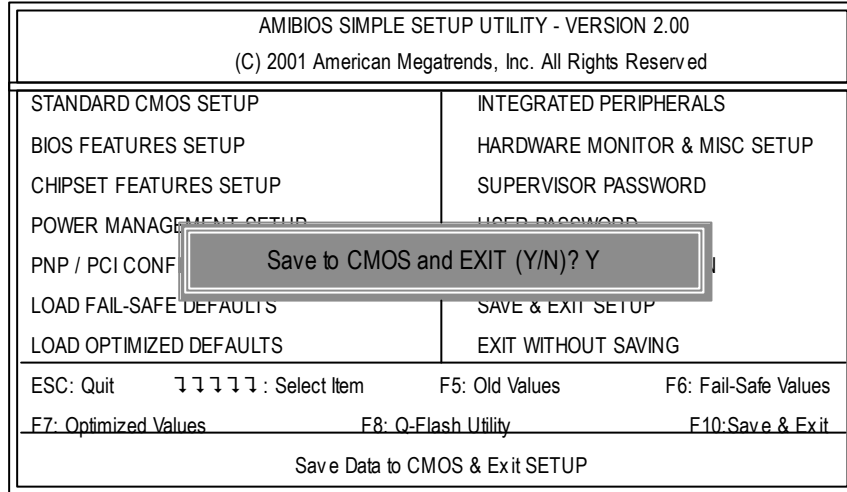

Figure 13: Save & Exit Setup

Type "Y" will quit the Setup Utility and save the user setup value to RTC CMOS.

Type "N" will return to Setup Utility.

## Exit Without Saving

AMIBIOS SIMPLE SETUP UTILITY - VERSION 2.00 (C) 2001 American Megatrends, Inc. All Rights Reserved	
STANDARD CMOS SETUP	INTEGRATED PERIPHERALS
BIOS FEATURES SETUP	HARDWARE MONITOR & MISC SETUP
CHIPSET FEATURES SETUP	SUPERVISOR PASSWORD
POWER MANAGEMENT	Quit Without Saving (Y/N)? N
PNP / PCI CONFIGURATION	
LOAD FAIL-SAFE DEFAULTS	SAVE & EXIT SETUP
LOAD OPTIMIZED DEFAULTS	EXIT WITHOUT SAVING
ESC: Quit    ↑↑↑↑↑: Select Item    F5: Old Values    F6: Fail-Safe Values F7: Optimized Values    F8: Q-Flash Utility    F10: Save & Exit	
Abandon all Datas & Exit SETUP	

Figure 14: Exit Without Saving

Type "Y" will quit the Setup Utility without saving to RTC CMOS.

Type "N" will return to Setup Utility.

## Chapter 4 Technical Reference

### Block Diagram

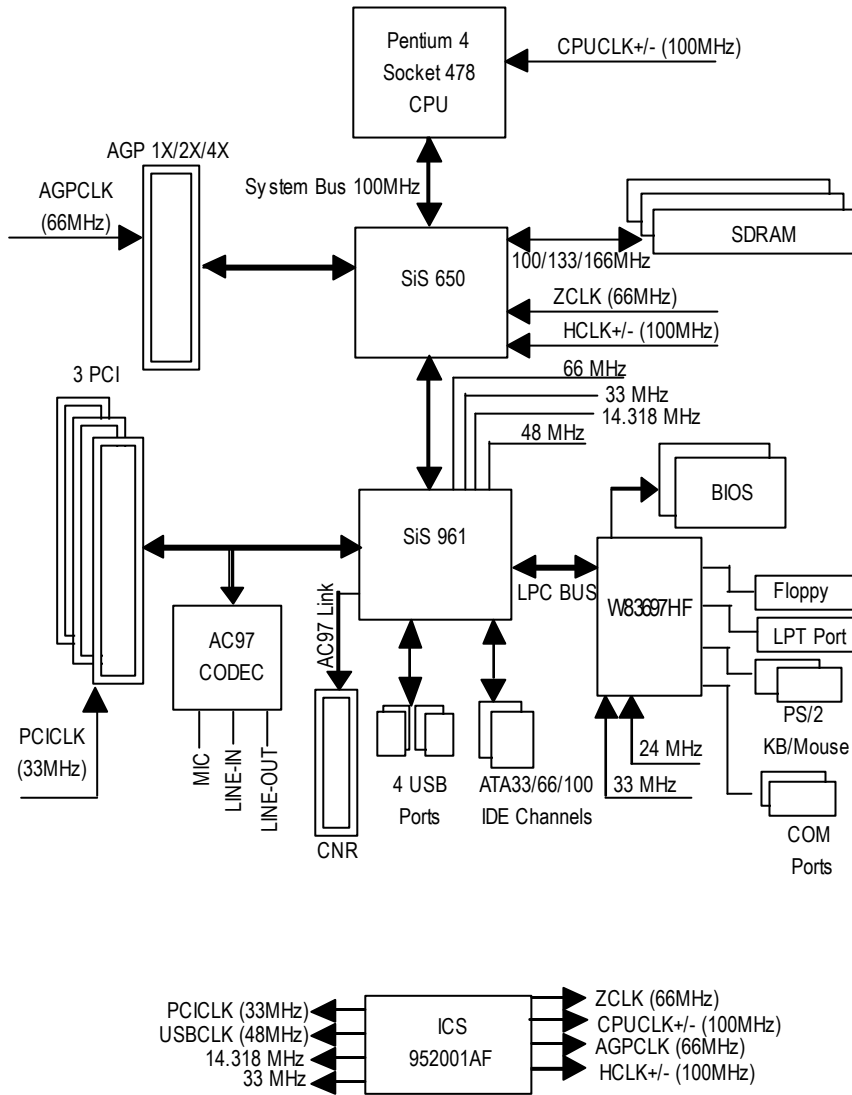

## @ BIOS™ Introduction

### Gigabyte announces @ BIOS Windows BIOS live update utility



Have you ever updated BIOS by yourself? Or like many other people, you just know what BIOS is, but always hesitate to update it? Because you think updating newest BIOS is unnecessary and actually you don't know how to update it.

Maybe not like others, you are very experienced in BIOS updating and spend quite a lot of time to do it. But of course you don't like to do it too much. First, download different BIOS from website and then switch the operating system to DOS mode. Secondly, use different flash utility to update BIOS. The above process is not a interesting job. Besides, always be carefully to store the BIOS source code correctly in your disks as if you update the wrong BIOS, it will be a nightmare.

Certainly, you wonder why motherboard vendors could not just do something right to save your time and effort and save you from the lousy BIOS updating work? Here it comes! Now Gigabyte announces @BIOS—the first Windows BIOS live update utility. This is a smart BIOS update software. It could help you to download the BIOS from internet and update it. Not like the other BIOS update software, it's a Windows utility. With the help of "@BIOS", BIOS updating is no more than a click.

Besides, no matter which mainboard you are using, if it's a Gigabyte's product\*, @BIOS help you to maintain the BIOS. This utility could detect your correct mainboard model and help you to choose the BIOS accordingly. It then downloads the BIOS from the nearest Gigabyte ftp site automatically. There are several different choices; you could use "Internet Update" to download and update your BIOS directly. Or you may want to keep a backup for your current BIOS, just choose "Save Current BIOS" to save it first. You make a wise choice to use Gigabyte, and @BIOS update your BIOS smartly. You are now worry free from updating wrong BIOS, and capable to maintain and manage your BIOS easily. Again, Gigabyte's innovative product erects a milestone in mainboard industries.

For such a wonderful software, how much it costs? Impossible! It's free! Now, if you buy a Gigabyte's motherboard, you could find this amazing software in the attached driver CD. But please remember, connected to internet at first, then you could have a internet BIOS update from your Gigabyte @BIOS.



## Chapter 5 Appendix

Picture below are shown in Windows ME (TUCD driver version 1.93)

### Appendix A: SiS 650 Chipset Driver Installation (Must Install!)

#### A. SiS 650 VGA Driver Installation

Insert the driver CD-title that came with your motherboard into your CD-ROM driver, the driver CD-title will auto start and show the installation guide. If not, please double click the CD-ROM device icon in "My computer", and execute the setup.exe.

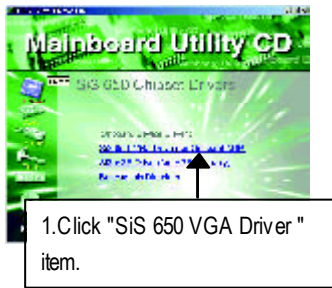

(1)

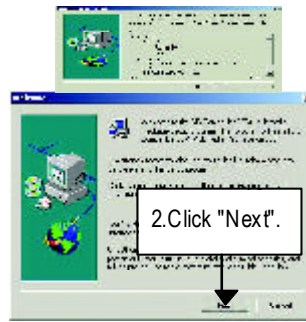

(2)



(3)

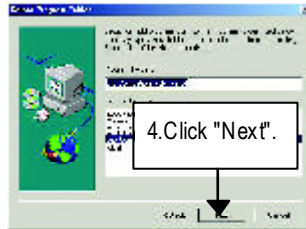

(4)



(5)



(6)

## B: SiS AGP Driver Installation

Insert the driver CD-title that came with your motherboard into your CD-ROM driver, the driver CD-title will auto start and show the installation guide. If not, please double click the CD-ROM device icon in "My computer", and execute the setup.exe.

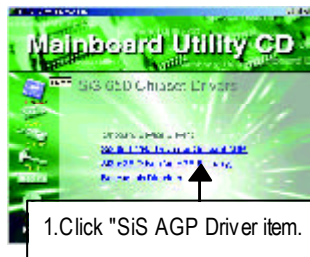

(1)



(2)

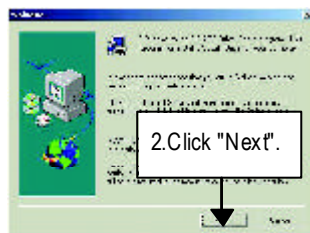

2. Click "Next".

(3)



3. Click "Next".

(4)



(5)

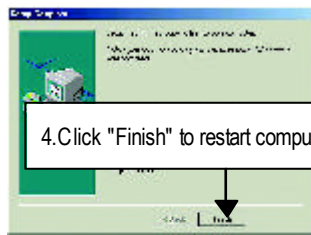

4. Click "Finish" to restart computer.

(6)

### Appendix B: SiS 7012 Sound Driver

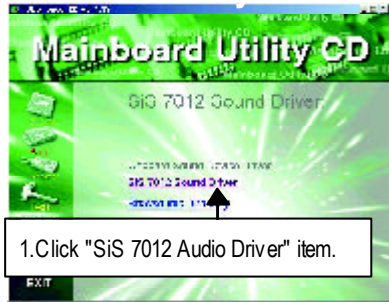

(1)

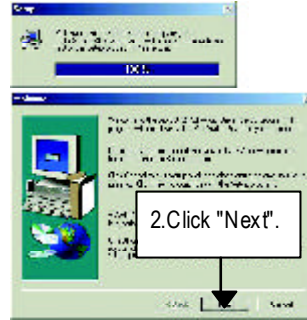

(2)

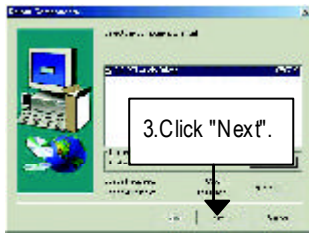

(3)



(4)

### Appendix C: RealTek 8100/8139 Network Driver

"RealTek 8100/8139 Network Driver" under Windows ME will auto install. If you would like to install LAN driver, please refer to attached README.txt file for detail instruction. Please install the driver through CD-ROM by the path D:\Network\Rtl (This manual assumes that your CD-ROM device drive letter is D:).



(1)

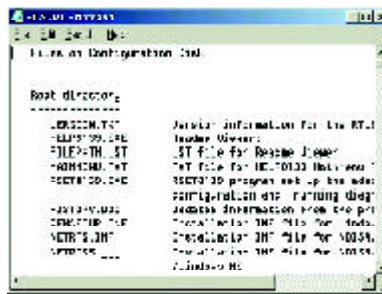

(2)

## Appendix D: BIOS Flash Procedure

BIOS update procedure:

If your OS is Win9X, we recommend that you used Gigabyte @BIOS™ Program to flash BIOS.

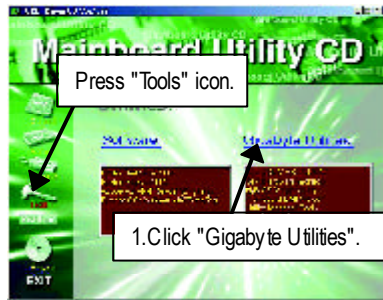

(1)

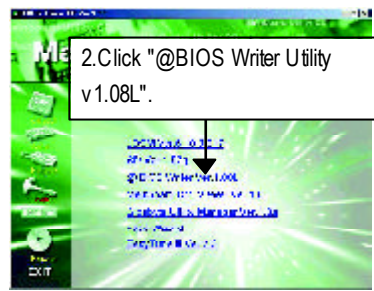

(2)



(3)

Methods and steps:

- I. Update BIOS through Internet
  - a. Click "Internet Update" icon
  - b. Click "Update New BIOS" icon
  - c. Select @BIOS™ sever ("Gigabyte @BIOS™ sever 1 in Taiwan" and "Gigabyte @BIOS™ sever 2 in Taiwan" are available for now, the others will be completed soon)
  - d. Select the exact model name on your motherboard
  - e. System will automatically download and update the BIOS.

II. Update BIOS NOT through Internet:

- a. Do not click "Internet Update" icon
- b. Click "Update New BIOS"
- c. Please select "All Files" in dialog box while opening the old file.
- d. Please search for BIOS unzip file, downloading from internet or any other methods (such as: 8SMML.F1).
- e. Complete update process following the instruction.

III. Save BIOS

In the very beginning, there is "Save Current BIOS" icon shown in dialog box. It means to save the current BIOS version.

IV. Check out supported motherboard and Flash ROM:

In the very beginning, there is "About this program" icon shown in dialog box. It can help you check out which kind of motherboard and which brand of Flash ROM are supported.

Note:

- a. In method I, if it shows two or more motherboard's model names to be selected, please make sure your motherboard's model name again. Selecting wrong model name will cause the system unbooted.
- b. In method II, be sure that motherboard's model name in BIOS unzip file are the same as your motherboard's. Otherwise, your system won't boot.
- c. In method I, if the BIOS file you need cannot be found in @BIOS™ server, please go onto Gigabyte's web site for downloading and updating it according to method II.
- d. Please note that any interruption during updating will cause system unbooted

We use GA-7VTX motherboard and Flash841 BIOS flash utility as example.

Please flash the BIOS according to the following procedures if you are now under the DOS mode.

Flash BIOS Procedure:

STEP 1:

- (1) Please make sure you have set "Auto" for BIOS Feature Setup (BIOS Flash Protection). For more detail please refer to page 28.
- (2) Please make sure your system has installed the extraction utility such as winzip or pkunzip.  
Firstly you have to install the extraction utility such as winzip or pkunzip for unzip the files. Both of these utilities are available on many shareware download pages like <http://www.shareware.cnet.com>

STEP 2: Make a DOS boot diskette. (See example: Windows 98 O.S.)

Beware: Windows ME/2000 are not allowed to make a DOS boot diskette.

- (1) With an available floppy disk in the floppy drive. Please leave the diskette "UN-write protected" type. Double click the "My Computer" icon from Desktop, then click "3.5 diskette (A)" and right click to select "Format (M)"

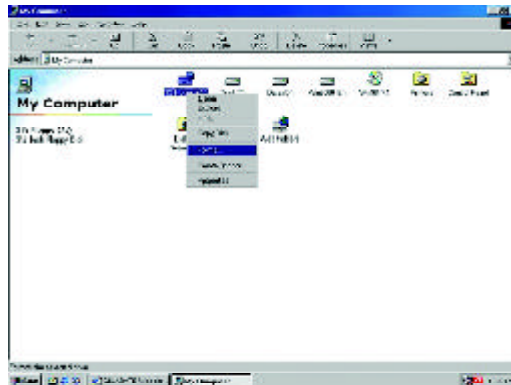

- (2) Select the "Quick (erase)" for Format Type, and pick both "Display summary when finished" and "Copy system files", after that press "Start". That will format the floppy and transfer the needed system files to it.

Beware: This procedure will erase all the prior data on that floppy, so please proceed accordingly.

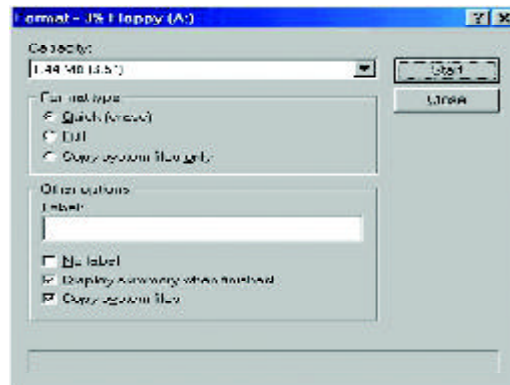

- (3) After the floppy has been formatted completely, please press "Close".

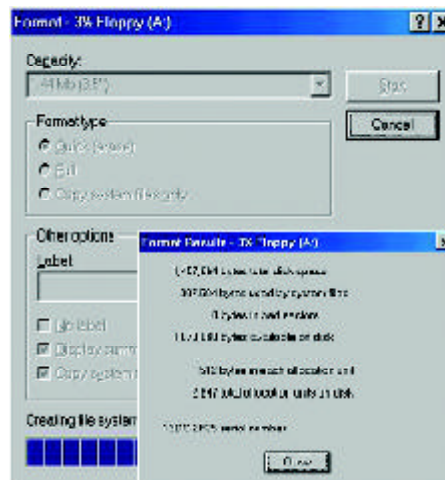

STEP 3: Download BIOS and BIOS utility program.

(1) Please go to Gigabyte website <http://www.gigabyte.com.tw/index.html>, and click "Support".



(2) From Support zone, click the "Motherboards BIOS & Drivers".

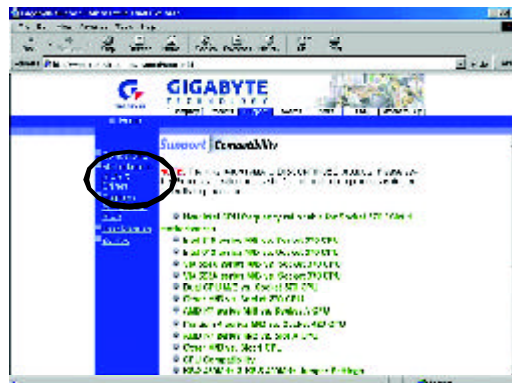



- (3) We use GA-7V7X motherboard as example. Please select GA-7V7X by Model or Chipset optional menu to obtain BIOS flash files.

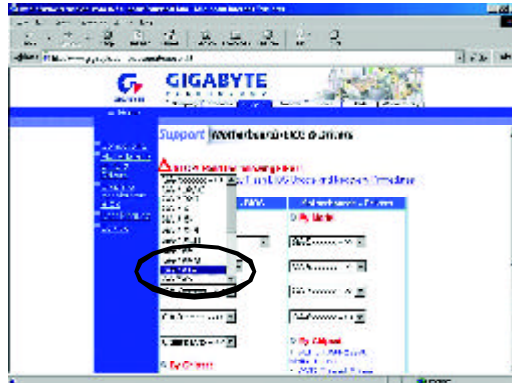

- (4) Select an appropriate BIOS version (For example: F4), and click to download the file. It will pop up a file download screen, then select the "Open this file from its current location" and press "OK".

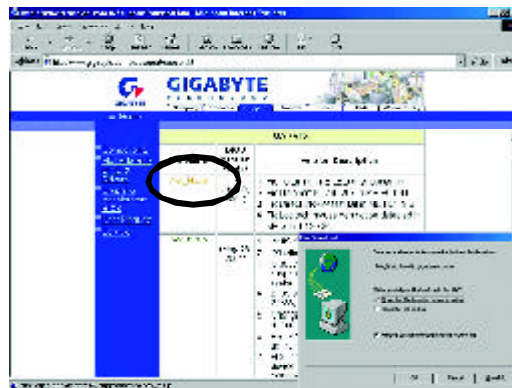

- (5) At this time the screen shows the following picture, please click "Extract" button to unzip the files.

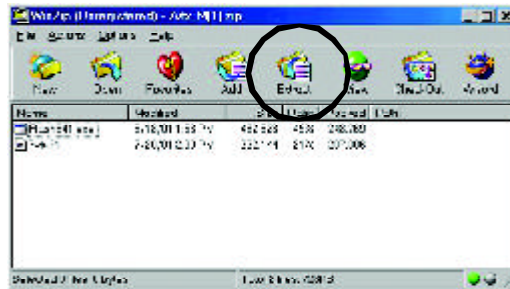

- (6) Please extract the download files into the clean bootable floppy disk A mentioned in STEP 2, and press "Extract".

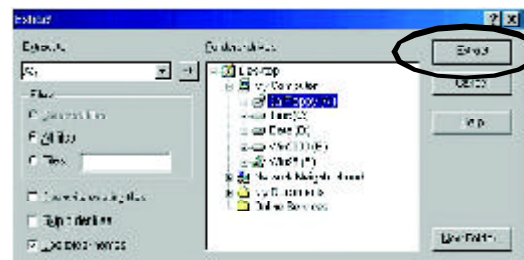

STEP 4: Make sure the system will boot from the floppy disk.

- (1) Insert the floppy disk (contains bootable program and unzip file) into the floppy drive A. Then, restart the system. The system will boot from the floppy disk. Please press <DEL> key to enter BIOS setup main menu when system is boot up.



- (2) Once you enter the BIOS setup utility, the main menu will appear on the screen. Use the arrows to highlight the item "BIOS FEATURES SETUP".

AMIBIOS SIMPLE SETUP UTILITY - VERSION 1.24b (C) 1999 American Megatrends, Inc. All Rights Reserved	
STANDARD CMOS SETUP <b>BIOS FEATURES SETUP</b> CHIPSET FEATURES SETUP POWER MANAGEMENT SETUP PNP / PCI CONFIGURATION LOAD BIOS DEFAULTS LOAD SETUP DEFAULTS	INTEGRATED PERIPHERALS HARDWARE MONITOR & MISC SETUP SUPERVISOR PASSWORD USER PASSWORD IDE HDD AUTO DETECTION SAVE & EXIT SETUP EXIT WITHOUT SAVING
ESC: Quit      ↓↓↓↓↓ : Select Item      (Shift)F2 : Change Color      F5: Old Values F6: Load BIOS Defaults      F7: Load Setup Defaults      F10: Save & Exit	
Time, Date , Hard Disk Type...	

(3) Press "Enter" to enter "BIOS FEATURES SETUP" menu. Use the arrows to highlight the item "1st Boot Device", and then use the "Page Up" or "Page Down" keys to select "Floppy".

AMIBIOS SETUP - BIOS FEATURES SETUP	
(C) 2001 American Megatrends, Inc. All Rights Reserved	
1st Boot Device : Floppy	
2nd Boot Device : IDE-0	
3rd Boot Device : CDROM	
S.M.A.R.T. for Hard Disks : Disabled	
BootUp Num-Lock : On	ESC: Quit      ↓ ↓ ↓ ↓ : Select Item
Floppy Drive Seek : Disabled	F1 : Help      PU/PD/+/- : Modify
Password Check : Setup	F5 : Old Values (Shift)F2: Color
	F6 : Load BIOS Defaults
	F7 : Load Setup Defaults

(4) Press "ESC" to go back to previous screen. Use the arrows to highlight the item "SAVE & EXIT SETUP" then press "Enter". System will ask "SAVE to CMOS and EXIT (Y/N)?" Press "Y" and "Enter" keys to confirm. Now the system will reboot automatically, the new BIOS setting will be taken effect next boot-up.

AMIBIOS SIMPLE SETUP UTILITY - VERSION 1.24b	
(C) 2001 American Megatrends, Inc. All Rights Reserved	
STANDARD CMOS SETUP	INTEGRATED PERIPHERALS
BIOS FEATURES SETUP	HARDWARE MONITOR & MISC SETUP
CHIPSET FEATURES SETUP	SUPERVISOR PASSWORD
POWER MANAGEMENT SETUP	USER PASSWORD
PNP / PCI CONF	SAVE to CMOS and EXIT (Y/N)? Y
LOAD BIOS DEFAULTS	SAVE & EXIT SETUP
LOAD SETUP DEFAULTS	EXIT WITHOUT SAVING
ESC: Quit      ↓ ↓ ↓ ↓ : Select Item      (Shift)F2 : Change Color      F5: Old Values	
F6: Load BIOS Defaults      F7: Load Setup Defaults      F10: Save & Exit	
Save Data to CMOS & Exit SETUP	

STEP 5: BIOS flashing.

- (1) After the system boot from floppy disk, type "A:\> dir/w" and press "Enter" to check the entire files in floppy A. Then type the "BIOS flash utility" and "BIOS file" after A:\>. In this case you have to type "A:\> Flash841 7VTX.F4" and then press "Enter".

```
Starting Windows 98...

Microsoft(R) Windows98
© Copyright Microsoft Corp 1981-1999

A:\> dir/w
Volume in drive A has no label
Volume Serial Number is 16EB-353D
Directory of A:\
COMMAND.COM  7VTX.F4  FLASH841.EXE
              3 file(s)  838,954 bytes
              0 dir(s)  324,608 bytes free

A:\> Flash841 7VTX.F4
```

- (2) Now screen appears the following Flash Utility main menu. Press "Enter", the highlighted item will locate on the model name of the right-upper screen. Right after that, press "Enter" to start BIOS Flash Utility.

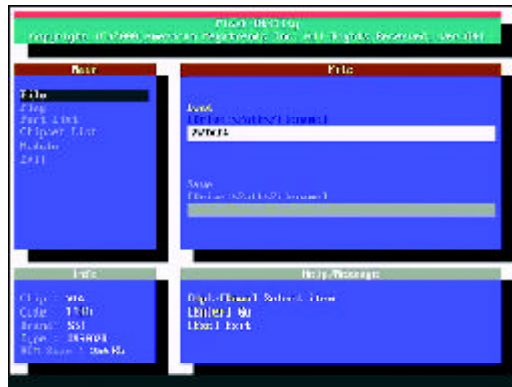

- (3) It will pop up a screen and asks "Are you sure to flash the BIOS?" Press [Enter] to continue the procedure, or press [ESC] to quit.

Beware: Please do not turn off the system while you are upgrading BIOS. It will render your BIOS corrupted and system totally inoperative.

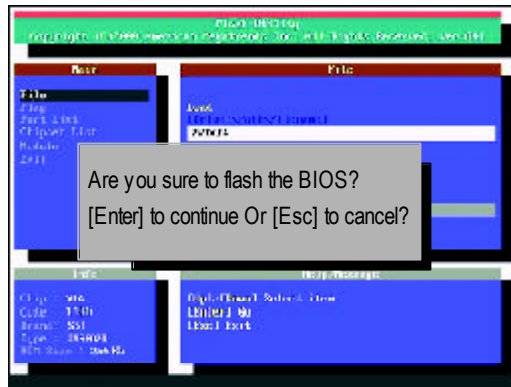

- (4) The BIOS flash completed. Please press [ESC] to exit Flash Utility.



STEP 6: Load BIOS defaults.

Normally the system redetects all devices after BIOS has been upgraded. Therefore, we highly recommend reloading the BIOS defaults after BIOS has been upgraded. This important step resets everything after the flash.

- (1) Take out the floppy diskette from floppy drive, and then restart the system. The boot up screen will indicate your motherboard model and current BIOS version.

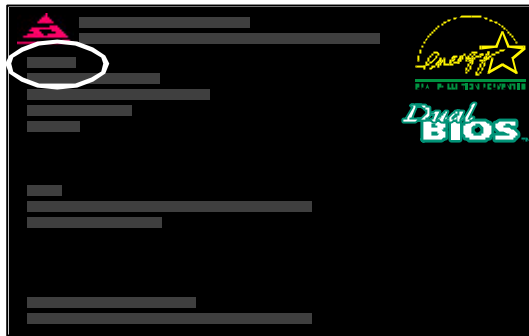

- (2) Don't forget to press <DEL> key to enter BIOS setup again when system is boot up. Use the arrows to highlight the item "LOAD SETUP DEFAULTS" then press "Enter". System will ask "Load Setup Defaults (Y/N)?" Press "Y" and "Enter" keys to confirm.

AMIBIOS SIMPLE SETUP UTILITY - VERSION 1.24b (C) 2001 American Megatrends, Inc. All Rights Reserved	
STANDARD CMOS SETUP	INTEGRATED PERIPHERALS
BIOS FEATURES SETUP	HARDWARE MONITOR & MISC SETUP
CHIPSET FEATURES SETUP	SUPERVISOR PASSWORD
POWER MANAGEMENT SETUP	MOUSE PASSWORD
PNP / PCI CONFIGURATION	Load Setup Defaults? (Y/N)?N
LOAD BIOS DEFAULTS	SAVE & EXIT SETUP
LOAD SETUP DEFAULTS	EXIT WITHOUT SAVING
ESC: Quit    ↑↓←→: Select Item    (Shift)F2: Change Color    F5: Old Values F6: Load BIOS Defaults    F7: Load Setup Defaults    F10: Save & Exit	
Load Setup Defaults	

- (3) Use the arrows to highlight the item "SAVE & EXIT SETUP" and press "Enter". System will ask "SAVE to CMOS and EXIT (Y/N)?" Press "Y" and "Enter" keys to confirm. Now the system will reboot automatically, the new BIOS setting will be taken effect next boot-up.

AMIBIOS SIMPLE SETUP UTILITY - VERSION 1.24b (C) 2001 American Megatrends, Inc. All Rights Reserved	
STANDARD CMOS SETUP	INTEGRATED PERIPHERALS
BIOS FEATURES SETUP	HARDWARE MONITOR & MISC SETUP
CHIPSET FEATURES SETUP	SUPERVISOR PASSWORD
POWER MANAGEMENT SETUP	USER PASSWORD
PNP / PCI CONF	SAVE & EXIT SETUP
LOAD BIOS DEFAULTS	EXIT WITHOUT SAVING
LOAD SETUP DEFAULTS	
ESC: Quit      ↑↓←→ : Select Item      (Shift)F2 : Change Color      F5: Old Values F6: Load BIOS Defaults      F7: Load Setup Defaults      F10: Save & Exit	
Save Data to CMOS & Exit SETUP	

- (4) Congratulate you have accomplished the BIOS flash procedure.



**Appendix D: Acronyms**

Acronyms	Meaning
ACPI	Advanced Configuration and Power Interface
APM	Advanced Power Management
AGP	Accelerated Graphics Port
AMR	Audio Modem Riser
ACR	Advanced Communications Riser
BIOS	Basic Input / Output System
CPU	Central Processing Unit
CMOS	Complementary Metal Oxide Semiconductor
CRIMM	Continuity RIMM
CNR	Communication and Networking Riser
DMA	Direct Memory Access
DMI	Desktop Management Interface
DIMM	Dual Inline Memory Module
DRM	Dual Retention Mechanism
DRAM	Dynamic Random Access Memory
DDR	Double Data Rate
ECP	Extended Capabilities Port
ESCD	Extended System Configuration Data
ECC	Error Checking and Correcting
EMC	Electromagnetic Compatibility
EPP	Enhanced Parallel Port
ESD	Electrostatic Discharge
FDD	Floppy Disk Device
FSB	Front Side Bus
HDD	Hard Disk Device
IDE	Integrated Dual Channel Enhanced
IRQ	Interrupt Request
I/O	Input / Output
IOAPIC	Input Output Advanced Programmable Input Controller
ISA	Industry Standard Architecture
LAN	Local Area Network

to be continued.....

---

Acronyms	Meaning
LBA	Logical Block Addressing
LED	Light Emitting Diode
MHz	Megahertz
MIDI	Musical Instrument Digital Interface
MTH	Memory Translator Hub
MPT	Memory Protocol Translator
NIC	Network Interface Card
OS	Operating System
OEM	Original Equipment Manufacturer
PAC	PCI A.G.P. Controller
POST	Power-On Self Test
PCI	Peripheral Component Interconnect
RIMM	Rambus in-line Memory Module
SCI	Special Circumstance Instructions
SECC	Single Edge Contact Cartridge
SRAM	Static Random Access Memory
SMP	Symmetric Multi-Processing
SMI	System Management Interrupt
USB	Universal Serial Bus
VID	Voltage ID

---

**Technical Support/RMA Sheet**

Customer/Country:	Company:	Phone No.:
Contact Person:	E-mail Add. :	

Model name/Lot Number:	PCB revision:
BIOS version:	O.S./A.S.:

Hardware Configuration	Mfs.	Model name	Size:	Driver/Utility:
CPU				
Memory				
Brand				
Video Card				
Audio Card				
HDD				
CD-ROM / DVD-ROM				
Modem				
Network				
AMR / CNR				
Keyboard				
Mouse				
Power supply				
Other Device				

Problem Description:

---



---