

# **6BXC**

## **USER'S MANUAL**

- 1. System power on by PS/2 Mouse: First, enable this function in CMOS Setup, then you can power on the system by double clicking the right or left button of your PS/2 Mouse.**
- 2. System power on by Keyboard: If your ATX power supply supports larger than 720 mA 5V Stand-By current, you can power on your system by entering password from the keyboard after setting the "Keyboard power on" password in CMOS Setup.**
- 3. Supports 3 steps ACPI LED.**
- 4. Modem Ring-On. (COM A , B)**
- 5. Wake-Up on LAN. (on JP7) (The ATX power supply supports larger than 600 mA 5V Stand-By current)**

**Pentium® II Processor MAINBOARD**

REV. 1.0 First Edition

R-01-01-080514



The author assumes no responsibility for any errors or omissions which may appear in this document nor does it make a commitment to update the information contained herein.

**Third-party brands and names are the property of their respective owners.**

Sound Blaster is a registered trademark of Creative Technology Ltd in the United States and certain other countries. Sound Blaster-LINK and SB-LINK are trademarks of Creative Technology Ltd.

MAY 14, 1998 Taipei, Taiwan

**I. Quick Installation Guide :**

**CPU SPEED SETUP**

The system bus speed is selectable between 66.6 / 100 MHz. The user can select the system bus speed (**SW1**) and change the DIP SWITCH (**SW2**) selection to set up the CPU speed for 200 - 633MHz processor.

**Set System Bus Speed**

**SW1:**

| CPU     | AGP    | 1   | 2   | 3   | 4   |
|---------|--------|-----|-----|-----|-----|
| 66 MHz  | 66 MHz | ON  | OFF | OFF | ON  |
| 100 MHz | 66 MHz | OFF | OFF | OFF | OFF |

The CPU speed **MUST** match with the frequency **RATIO**. It will cause system hanging up if the frequency **RATIO** is higher than that of CPU.

**SW2:**

| CLK RATIO | 1   | 2   | 3   | 4  |
|-----------|-----|-----|-----|----|
| X3        | ON  | OFF | ON  | ON |
| X3.5      | OFF | OFF | ON  | ON |
| X4        | ON  | ON  | OFF | ON |
| X4.5      | OFF | ON  | OFF | ON |
| X5        | ON  | OFF | OFF | ON |
| X5.5      | OFF | OFF | OFF | ON |

1. Pentium® II 233 / 66 MHz FSB

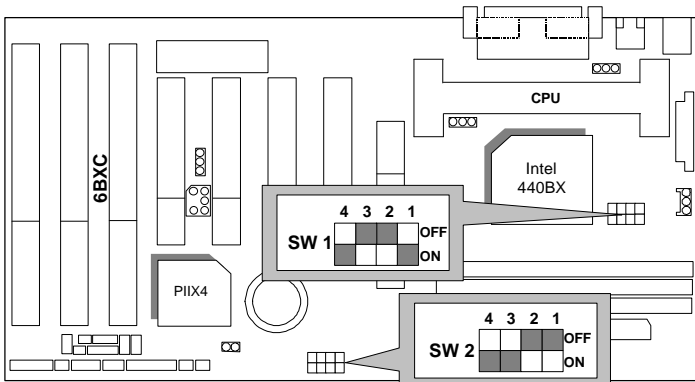

2. Pentium® II 266 / 66 MHz FSB

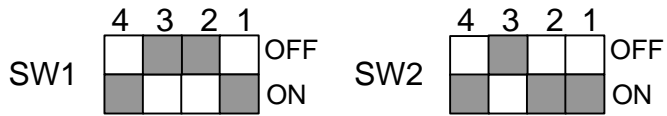

3. Pentium® II 300 / 66 MHz FSB

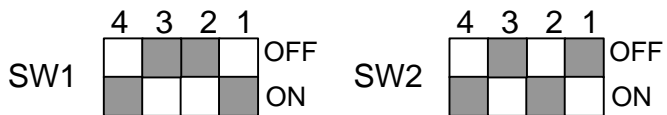

4. Pentium® II 333 / 66 MHz FSB

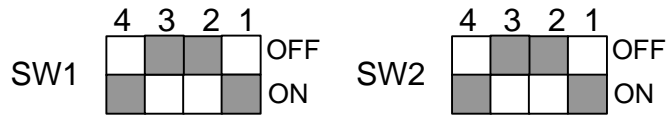

5. Pentium® II 366 / 66MHz FSB

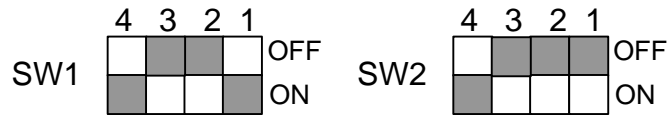

6. Pentium® II 300 / 100 MHz FSB

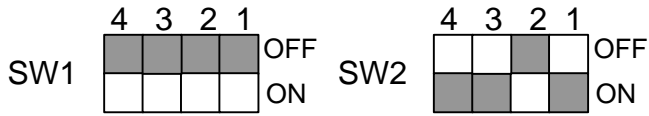

7. Pentium® II 350 / 100 MHz FSB

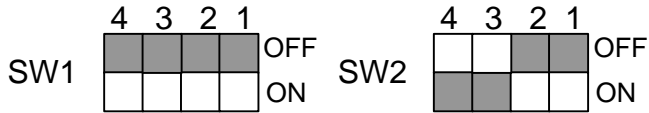

8. Pentium® II 400 / 100 MHz FSB

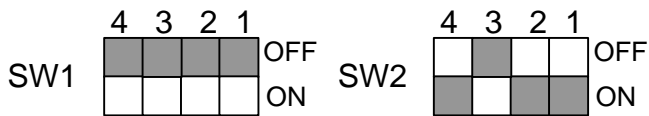

9. Pentium® II 450 / 100 MHz FSB



10. Pentium® II 500 / 100 MHz FSB

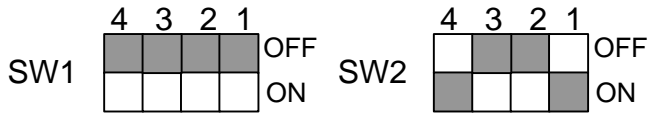

11. Pentium® II 550 / 100 MHz FSB



## II. Jumper setting :

SPK : Speaker Connector

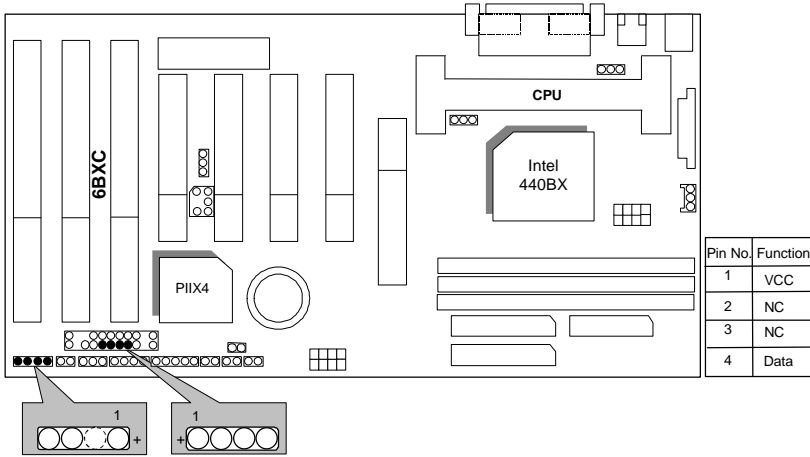

RST : Reset Switch

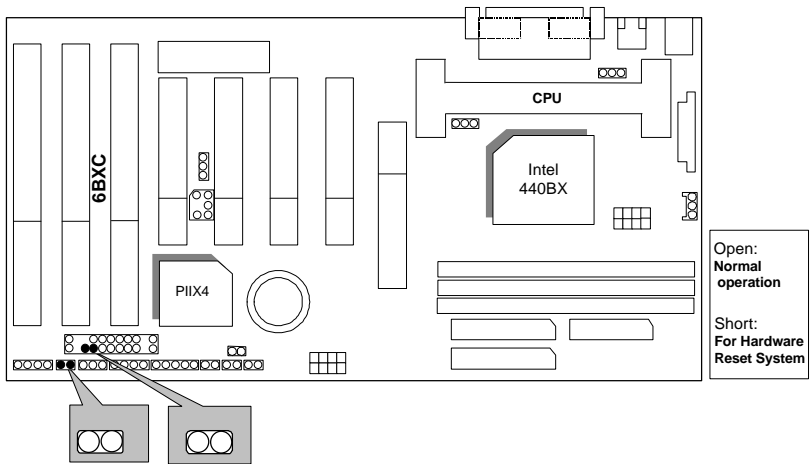

PW LED : Power LED Connector

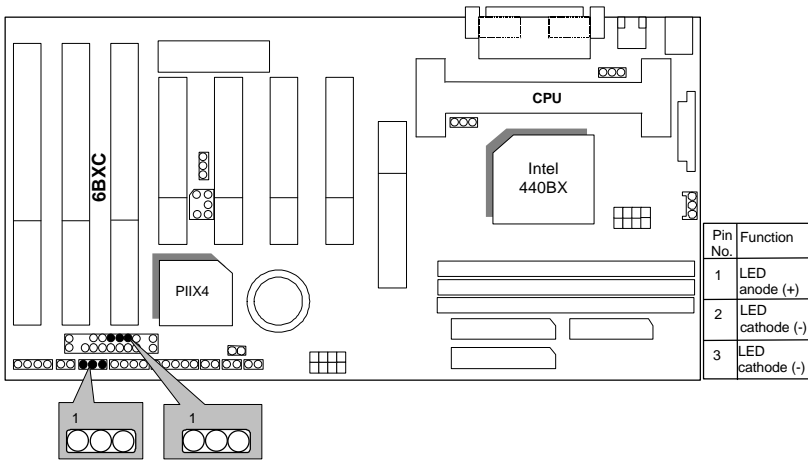

HD : IDE Hard Disk Active LED

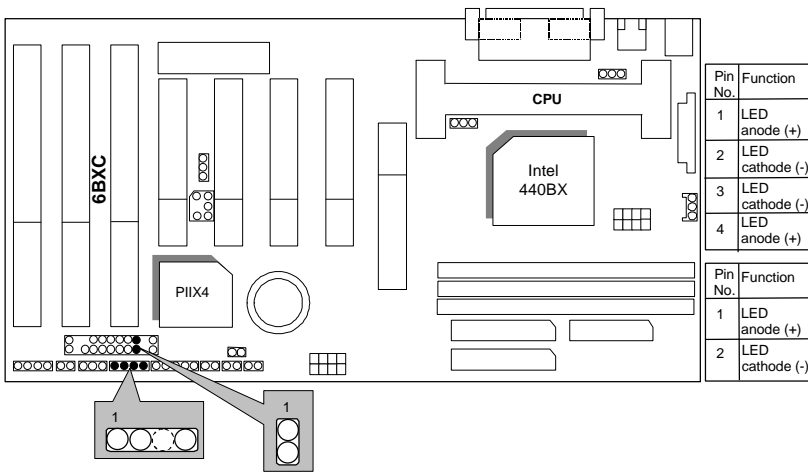



IR : Infrared Connector (Optional)

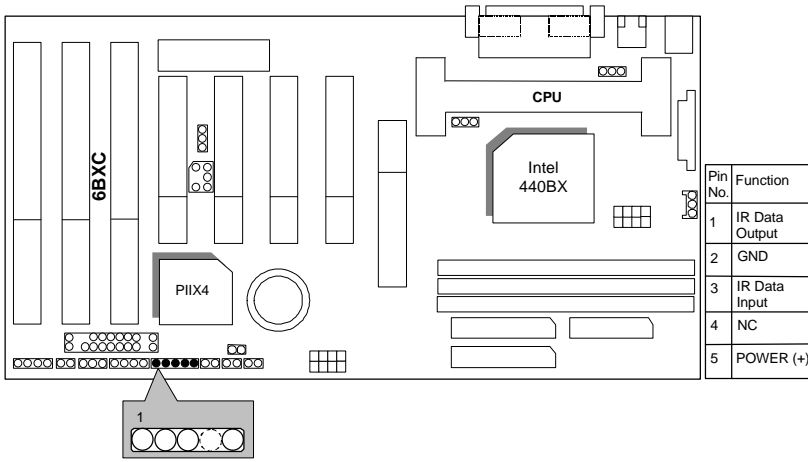

GN : Green Function Switch

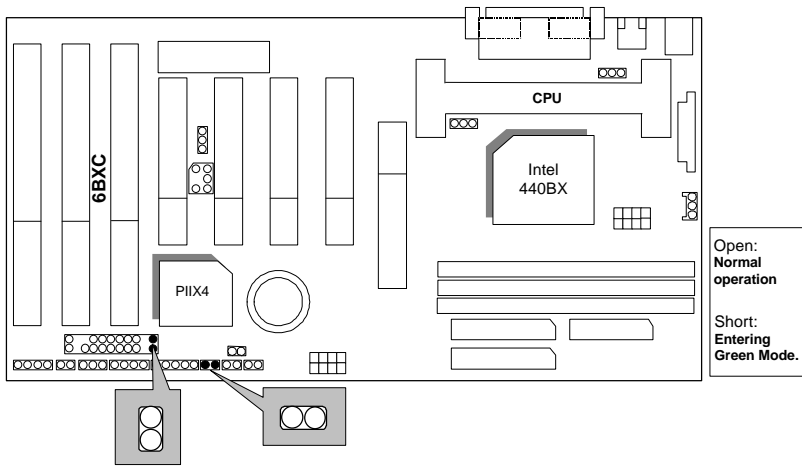

GD : Green LED

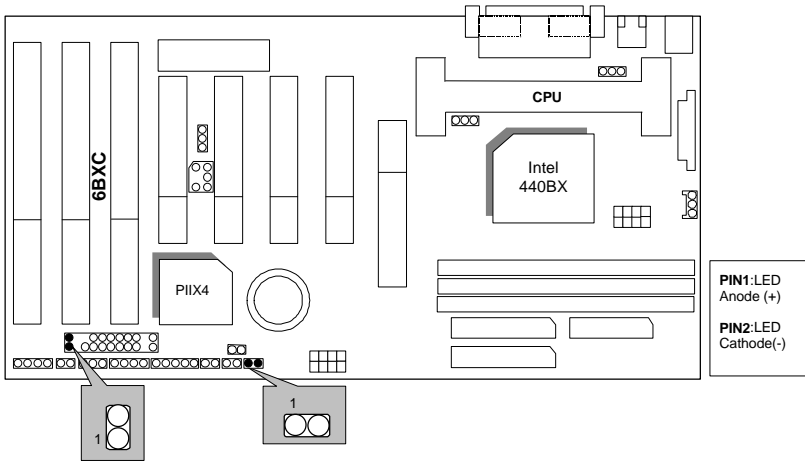

Soft POWER : Soft Power Connector

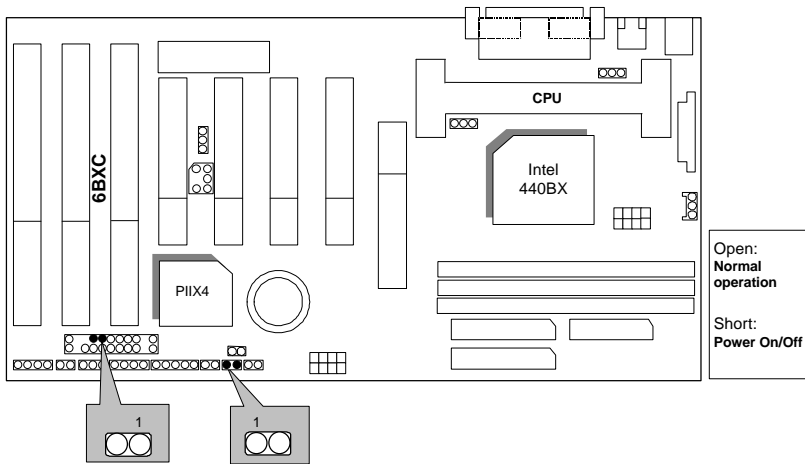

POWER1 : Power Connector

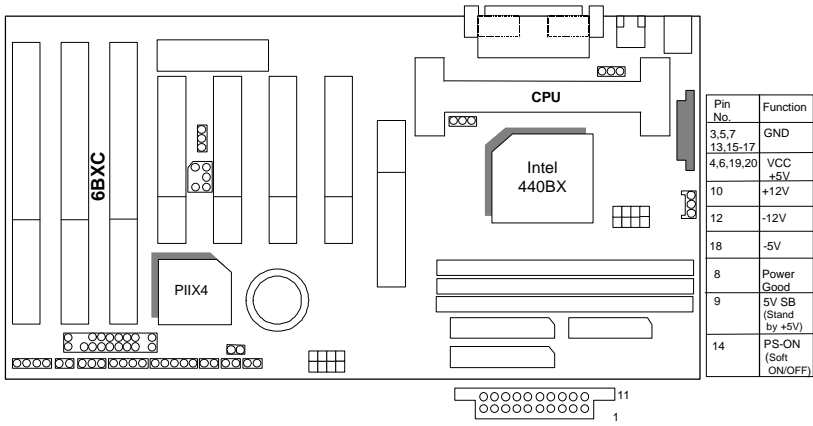

PS/2 Mouse / Keyboard Connector

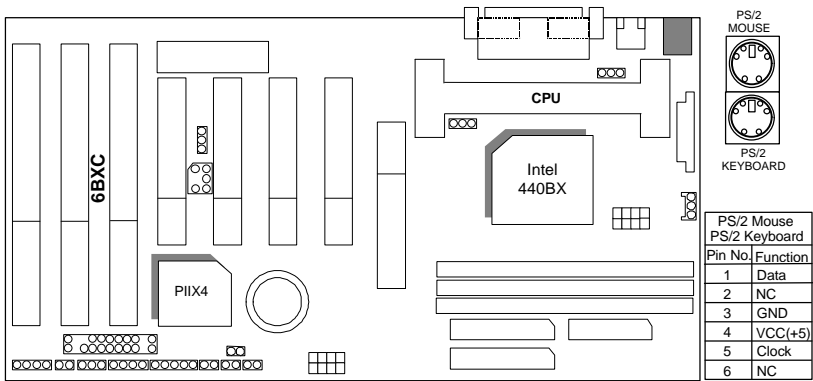

PWR FAN : CPU Cooling Fan Power Connector

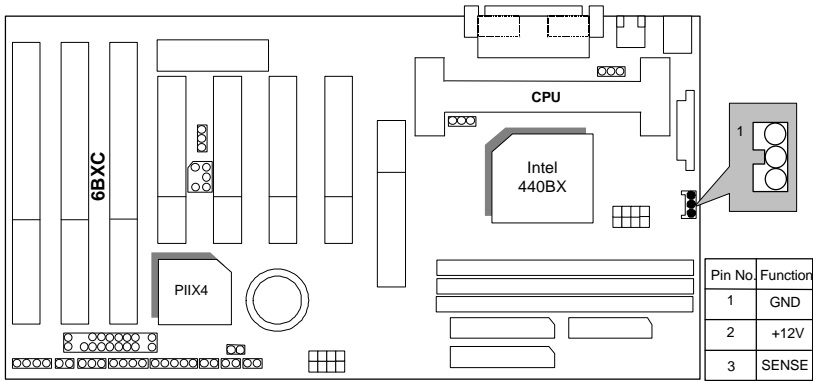

IDE1: For Primary IDE port

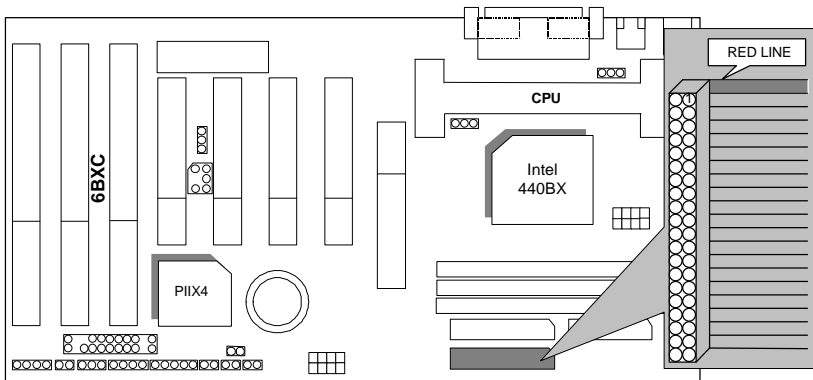

IDE2: For Secondary IDE port

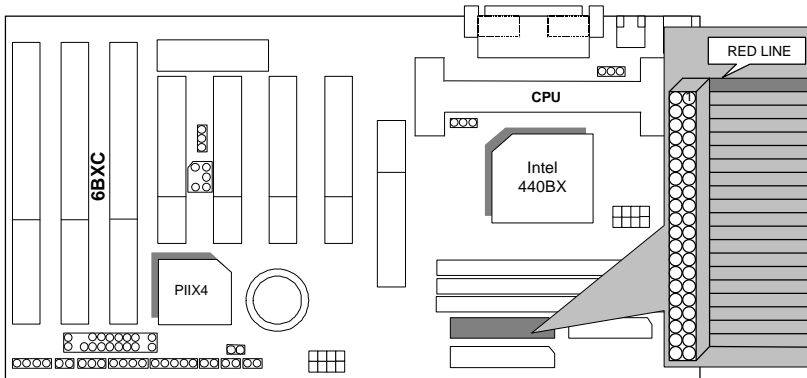

FLOPPY : FLOPPY PORT

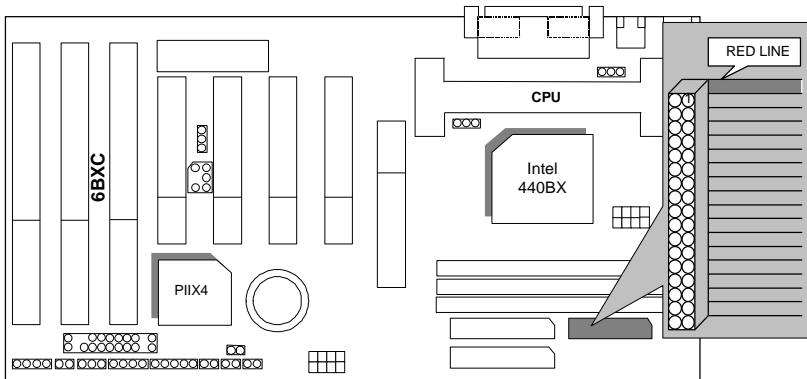

LPT PORT / COM A / COM B

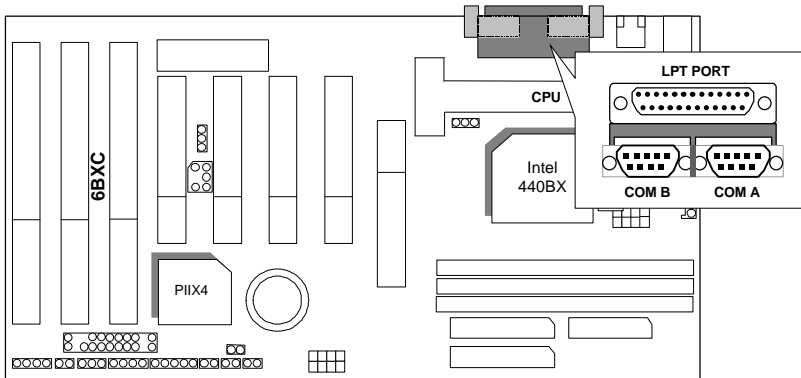

JP1 : Keyboard Power On Selection

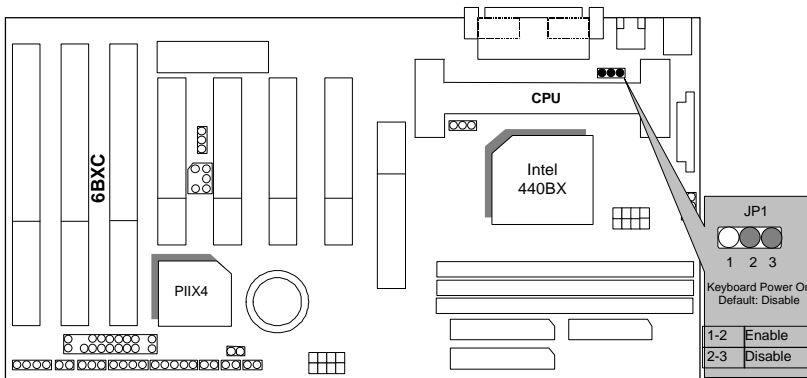

USB : USB Port

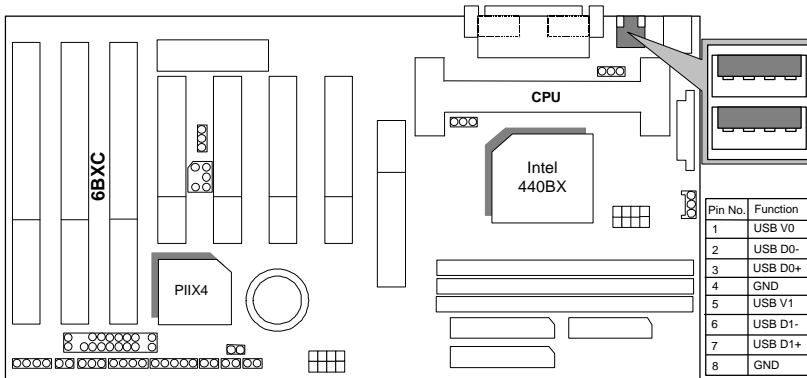

J15: System After AC Back

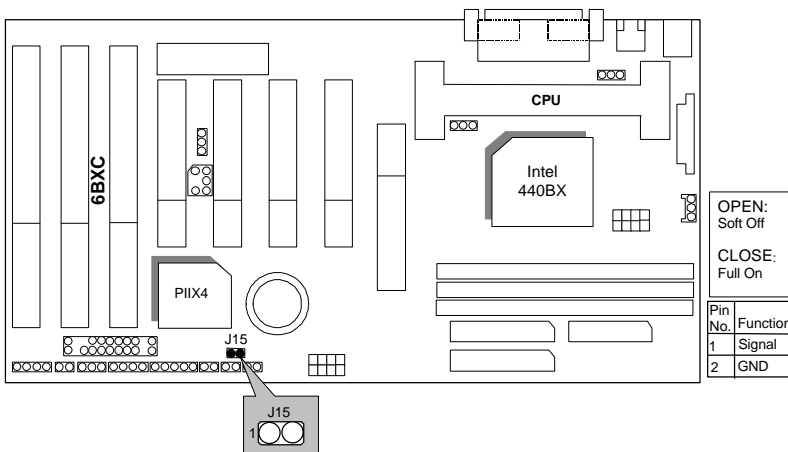

JP7: Wake On LAN

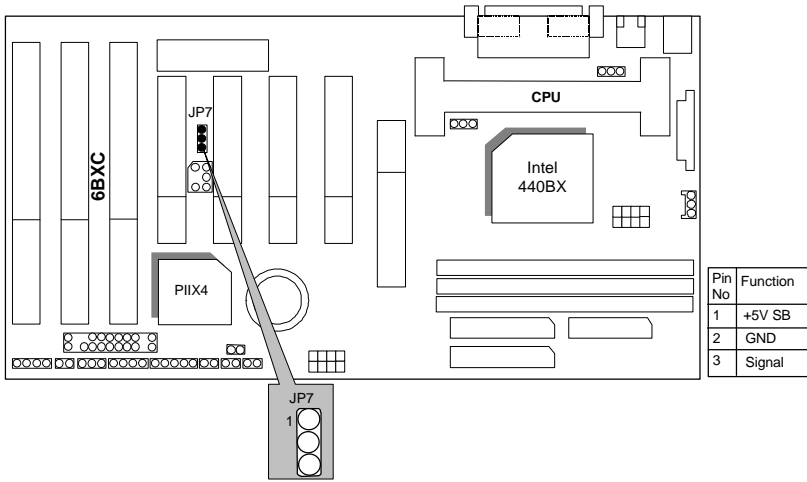

JP8:SB-LINK Creative PCI Sound Card Support

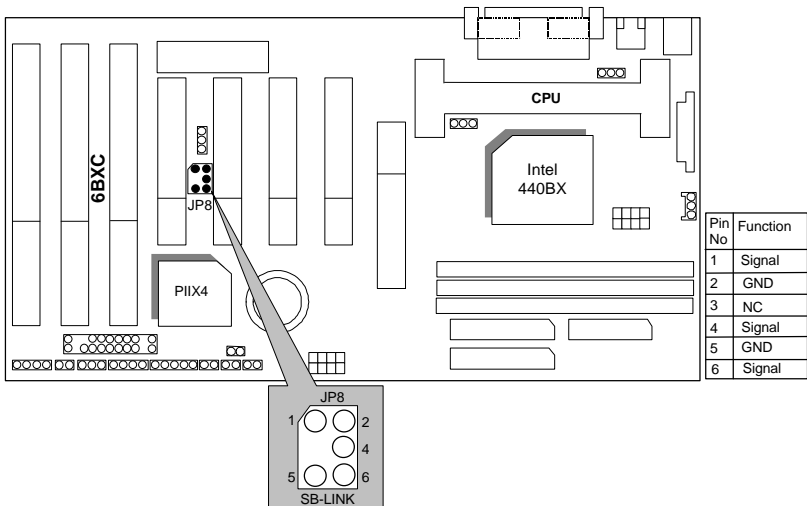



JP10 : System Acceleration

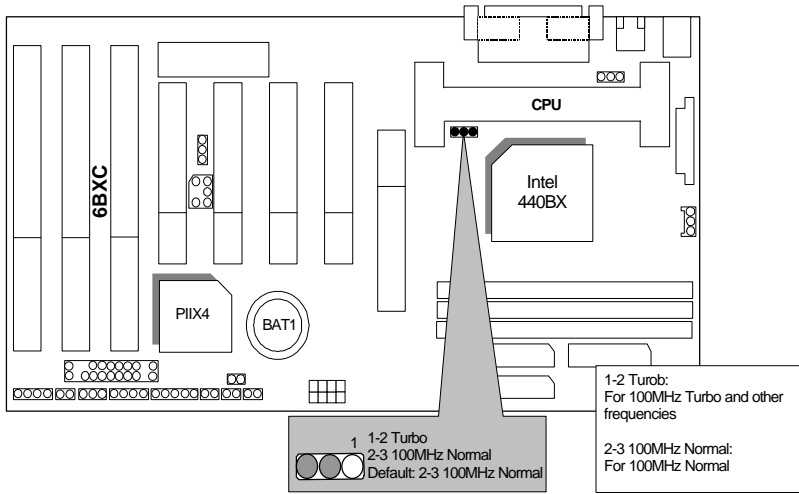

BAT1 :BATTERY

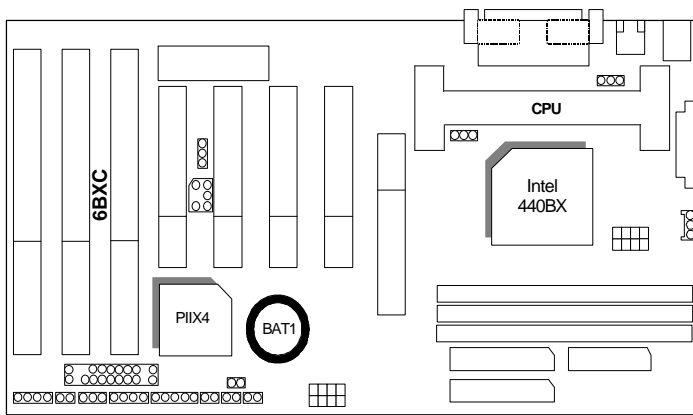

**Danger of explosion if battery is incorrectly replaced.**  
**Replace only with the same or equivalent type recommended by the manufacturer.**  
**Dispose of used batteries according to the manufacturer's instructions.**

### III. Top Performance Test Setting:

The following performance data list is the testing results of some popular benchmark testing programs.

Users have to modify the value for each item in chipset features as follow for top performance setting.

```

ROM PCI/ISA BIOS (2A69KG0C)
CHIPSET FEATURES SETUP
AWARD SOFTWARE, INC.

EDO CAS# MA Wait State      : 1
EDO RAS# Wait State         : 1
SDRAM CAS Latency Time     : 2
DRAM Data Integrity Mode   : Non-ECC
System BIOS Cacheable     : Enabled
Video BIOS Cacheable       : Enabled
Video RAM Cacheable        : Disabled
16 Bit I/O Recovery Time   : 1
Memory Hole At 15M-16M    : Disabled
Delayed Transaction        : Disabled
Spread Spectrum            : Disabled

ESC : Quit          ↑↓←→ : Select Item
F1  : Help          PU/PD/+/- : Modify
F5  : Old Values   (Shift)F2 : Color
F6  : Load BIOS Defaults
F7  : LOAD PERFORMANCE DEFAULTS
    
```

These data are just referred by users, and there is no responsibility for different testing data values gotten by users. (Different Hardware & Software configuration will result in different benchmark testing results.)

- CPU Pentium® II processor
- DRAM 128 MB SDRAM (SEC KM48S8030BT-GH)
- CACHE SIZE 512 KB included in CPU
- DISPLAY GA-601 AGP Display Card (4MB SGRAM)
- STORAGE Onboard IDE (IBM DHEA-38451)
- O.S. Windows NT™4.0
- DRIVER Display Driver at 1024 x 768 x 256 colors x 75Hz.  
TRIONES Bus Master IDE Driver 3.70

| Processor         | Intel Pentium® II |                 |
|-------------------|-------------------|-----------------|
|                   | 333MHz(66x5)      | 350MHz(100x3.5) |
| <b>Winbench98</b> |                   |                 |
| CPU mark32        | 864               | 947             |
| FPU Winmark       | 1720              | 1810            |
| Business Disk     | 1850              | 1900            |
| Hi-End Disk       | 4590              | 4690            |
| Business Graphics | 185               | 204             |
| Hi-End Graphics   | 207               | 232             |
| <b>Winstone98</b> |                   |                 |
| Business          | 33.3              | 34.6            |
| Hi-End            | 36.9              | 39.2            |

