

# 6BXC

## USER'S MANUAL

1. **System power on by PS/2 Mouse:** First, enable this function in CMOS Setup, then you can power on the system by double clicking the right or left button of your PS/2 Mouse.
  2. **System power on by Keyboard:** If your ATX power supply supports larger than 100~300 mA 5V Stand-By current (dependent on the specification of keyboards), you can power on your system by entering password from the keyboard after setting the "Keyboard power on" password in CMOS Setup.
  3. **Supports 3 steps ACPI LED.**
  4. **Modem Ring-On. (COM A , B).**
  5. **Wake-Up on LAN. (on JP7) (The ATX power supply supports larger than 720 mA 5V Stand-By current)**
- **System/Power Fan, Clear CMOS, Internal Ring Pwr on and Power connector function only for PCB Rev:1.9 use, please reference page 10, 16~18.**

**For Intel Pentium® II / Celeron™ Processor MAINBOARD  
REV. 1.9 First Edition**

R-19-01-081126



The author assumes no responsibility for any errors or omissions which may appear in this document nor does it make a commitment to update the information contained herein.

**Third-party brands and names are the property of their respective owners.**

Sound Blaster is a registered trademark of Creative Technology Ltd in the United States and certain other countries. Sound Blaster-LINK and SB-LINK are trademarks of Creative Technology Ltd.

November 26, 1998 Taipei, Taiwan

**I. Quick Installation Guide :**

## CPU SPEED SETUP

The system bus speed is selectable between 66 / 100 MHz. The user can select the system bus speed (**SW1**) and change the DIP SWITCH (**SW2**) selection to set up the CPU speed for 233 - 633MHz processor.

### Set System Bus Speed

#### SW1:

CPU	AGP	1	2	3	4
100 MHz	66 MHz	OFF	OFF	OFF	OFF
133 MHz	89 MHz	OFF	OFF	ON	OFF
112 MHz	75 MHz	OFF	ON	OFF	OFF
66 MHz	66 MHz	ON	OFF	OFF	ON
75 MHz	75 MHz	ON	ON	OFF	ON
83 MHz	83 MHz	ON	OFF	ON	ON

The CPU speed **MUST** match with the frequency **RATIO**. It will cause system hanging up if the frequency **RATIO** is higher than that of CPU.

#### SW2:

CLK RATIO	1	2	3	4
X3	ON	OFF	ON	ON
X3.5	OFF	OFF	ON	ON
X4	ON	ON	OFF	ON
X4.5	OFF	ON	OFF	ON
X5	ON	OFF	OFF	ON
X5.5	OFF	OFF	OFF	ON
X6	ON	ON	ON	OFF
X6.5	OFF	ON	ON	OFF

★ **Note:** We don't recommend you to setup your system speed to 75, 83, 112 or 133MHz because these frequencies are not the standard specifications for CPU, Chipset and most of the peripherals. Whether your system can run under 75, 83, 112 or 133MHz properly will depend on your hardware configurations: CPU, SDRAM, Cards, etc.

1. Pentium® II /Celeron 233 / 66 MHz FSB

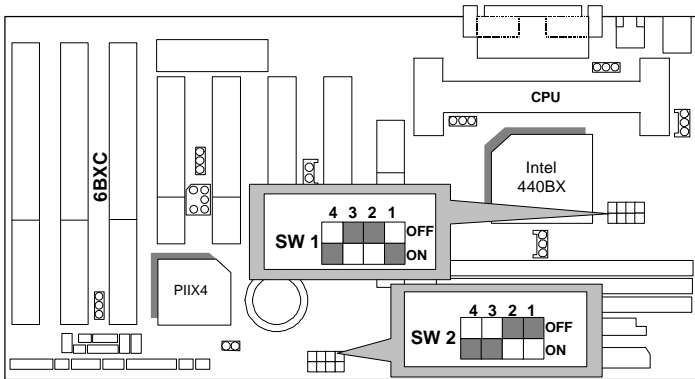

2. Pentium® II /Celeron 266 / 66 MHz FSB

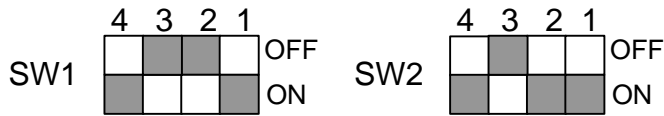

3. Pentium® II /Celeron 300/Celeron 300A / 66 MHz FSB



4. Pentium® II /Celeron 333 / 66 MHz FSB



5. Pentium® II /Celeron 366 / 66MHz FSB



6. Pentium® II /Celeron 400 / 66MHz FSB

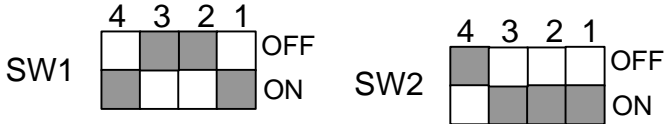

7. Pentium® II /Celeron 433 / 66MHz FSB

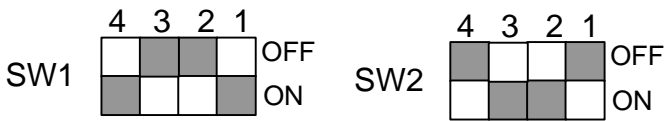

8. Pentium® II 350 / 100 MHz FSB

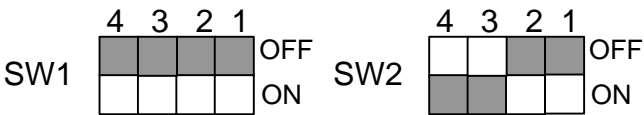

9. Pentium® II 400 / 100 MHz FSB

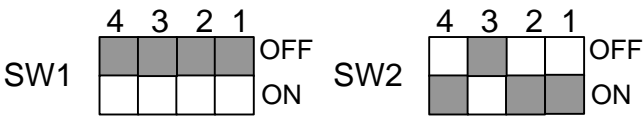

10. Pentium® II 450 / 100 MHz FSB

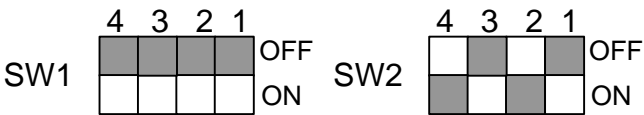

11. Pentium® II 500 / 100 MHz FSB

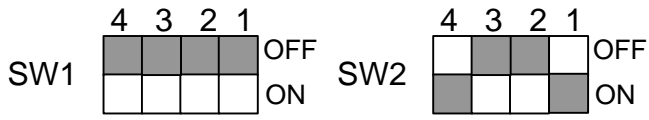

12. Pentium® II 550 / 100 MHz FSB

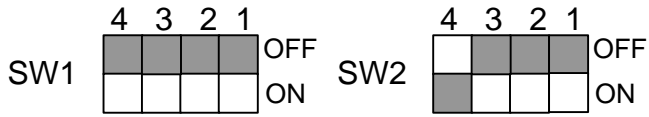

13. Pentium® II 600 / 100 MHz FSB

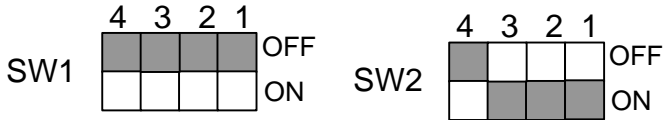

14. Pentium® II 650 / 100 MHz FSB

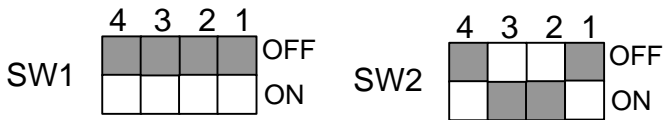

## II. Jumper setting :

SPK : Speaker Connector

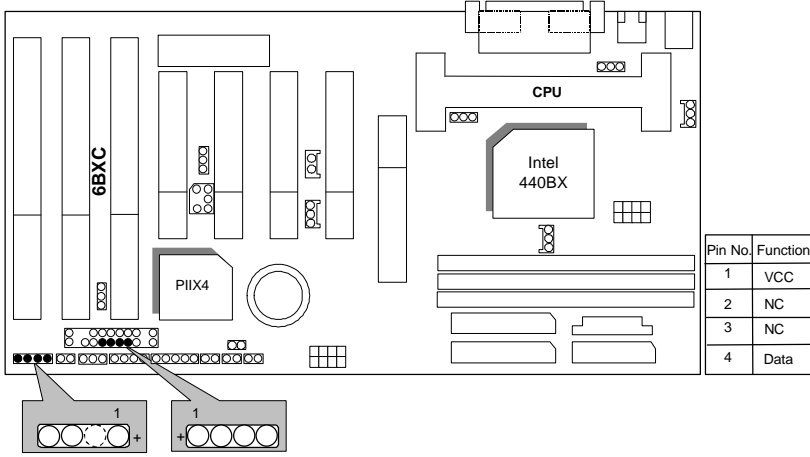

RST : Reset Switch

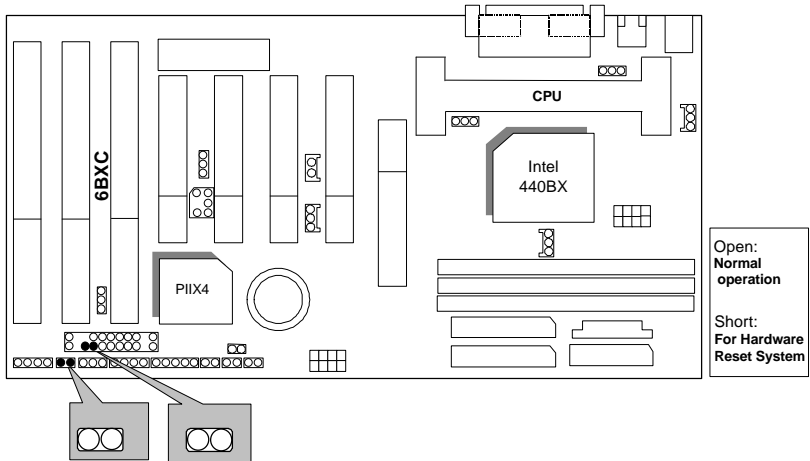



PW LED : Power LED Connector

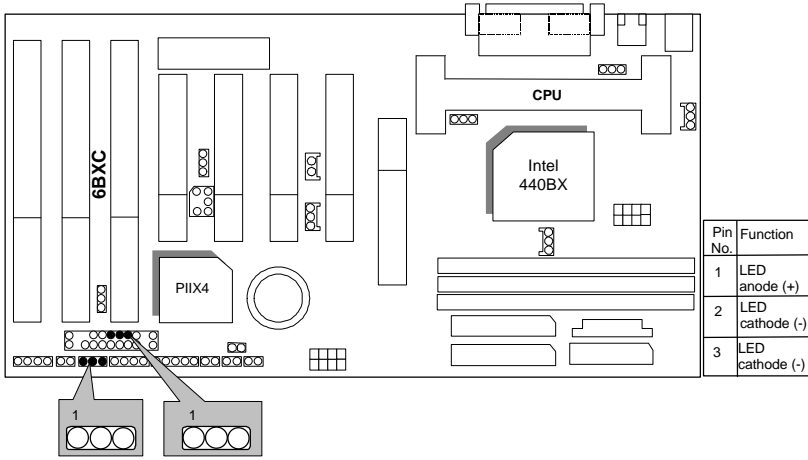

HD : IDE Hard Disk Active LED

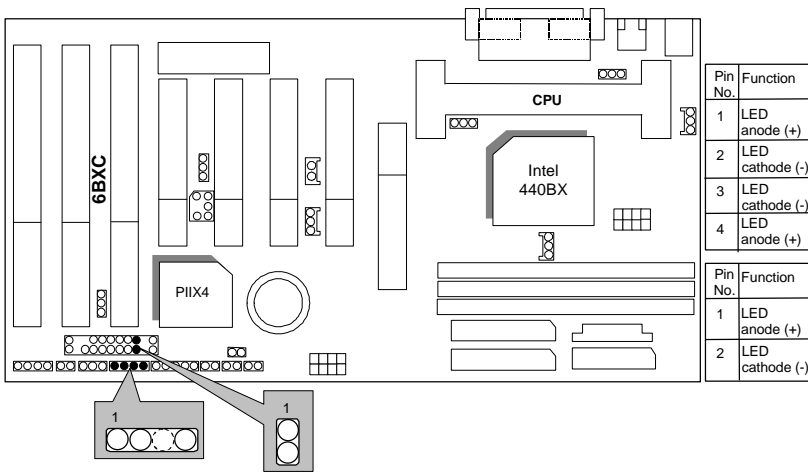

IR : Infrared Connector (Optional)

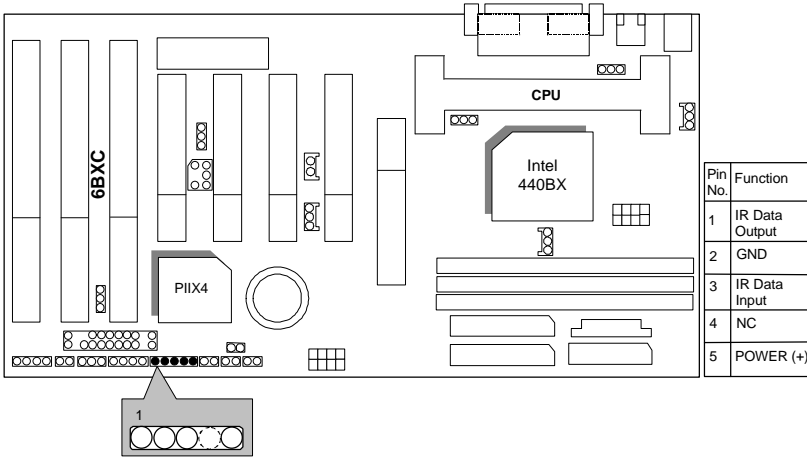

GN : Green Function Switch

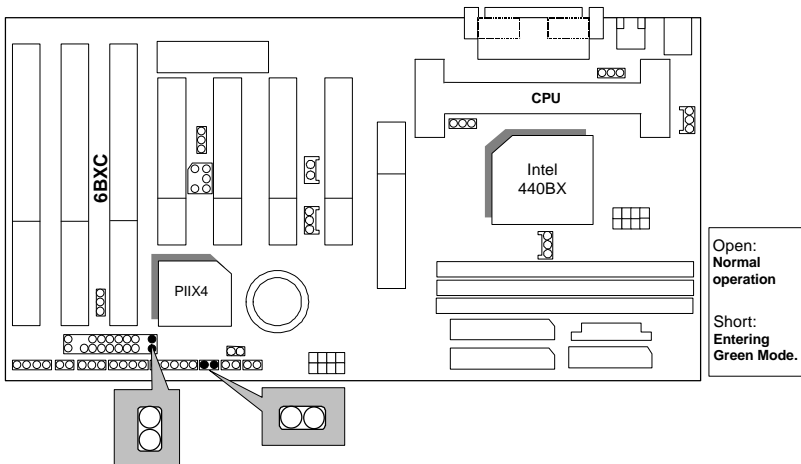

GD : Green LED

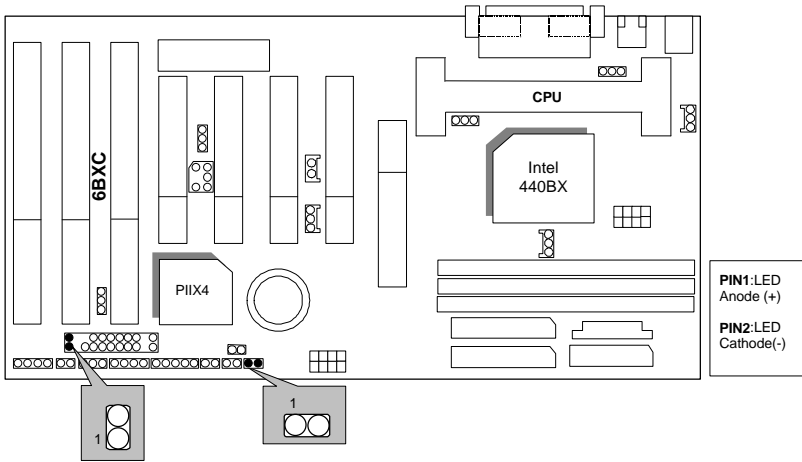

Soft POWER : Soft Power Connector

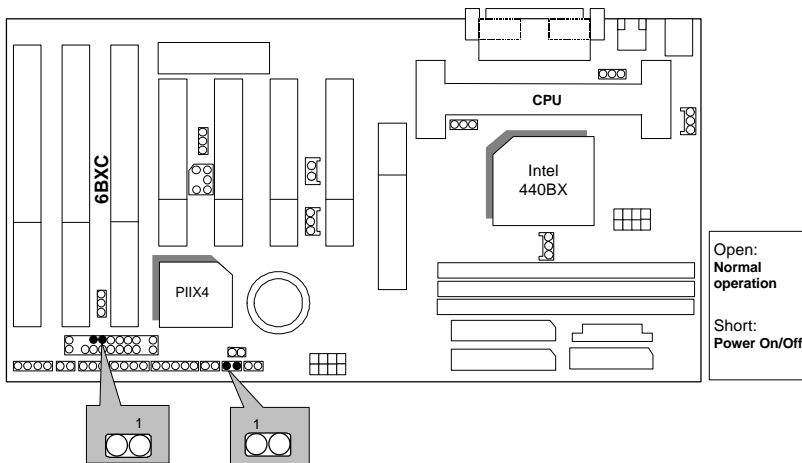

**POWER1 : Power Connector (Only for PCB Rev:1.9 use)**

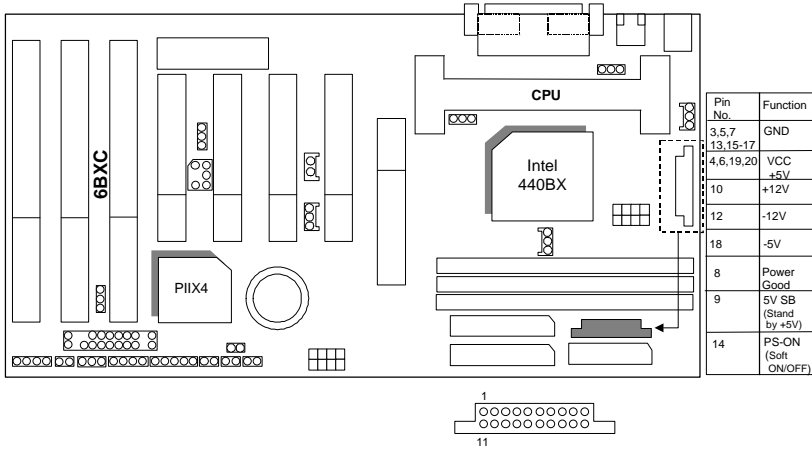

**PS/2 Mouse / Keyboard Connector**

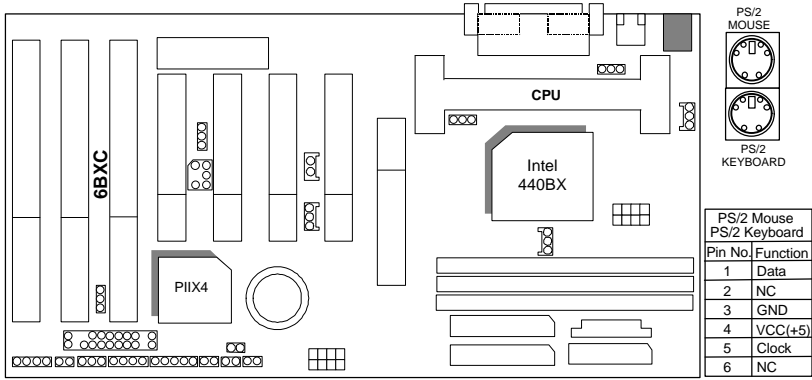

CPU FAN : CPU Cooling Fan Power Connector

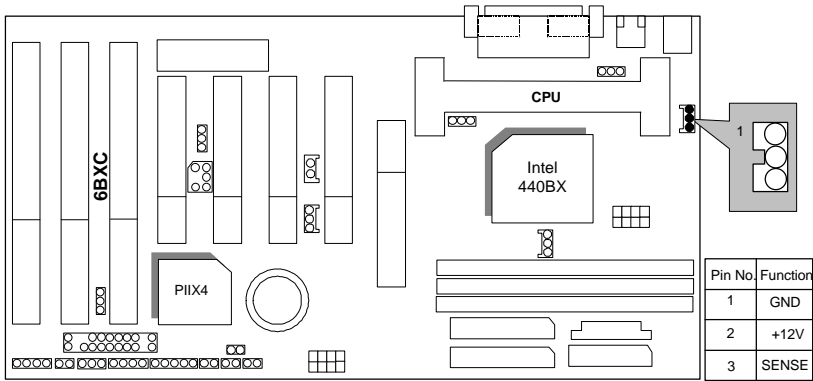

IDE1: For Primary IDE port

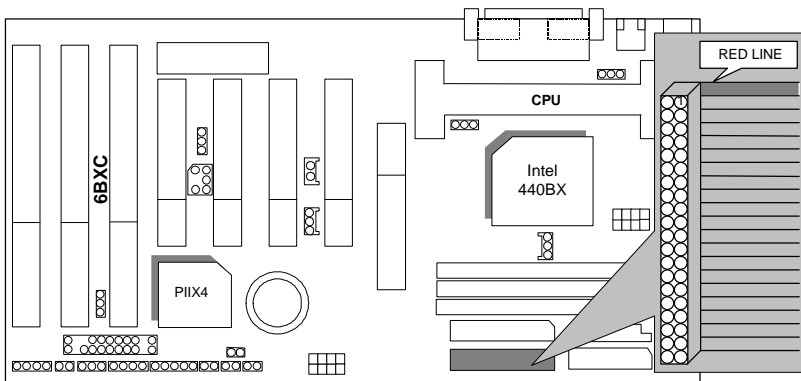

IDE2: For Secondary IDE port

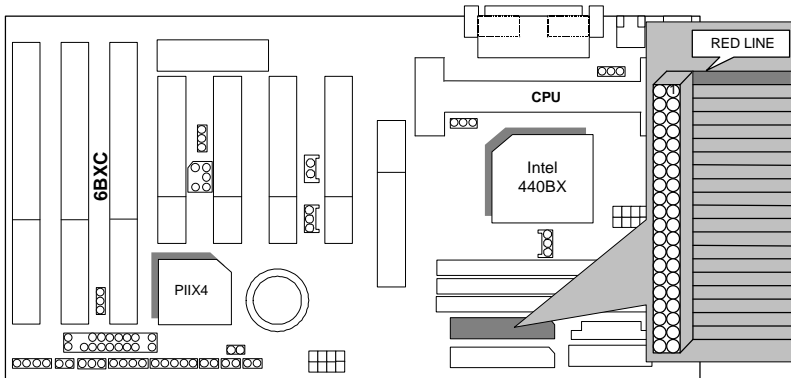

FLOPPY : FLOPPY PORT

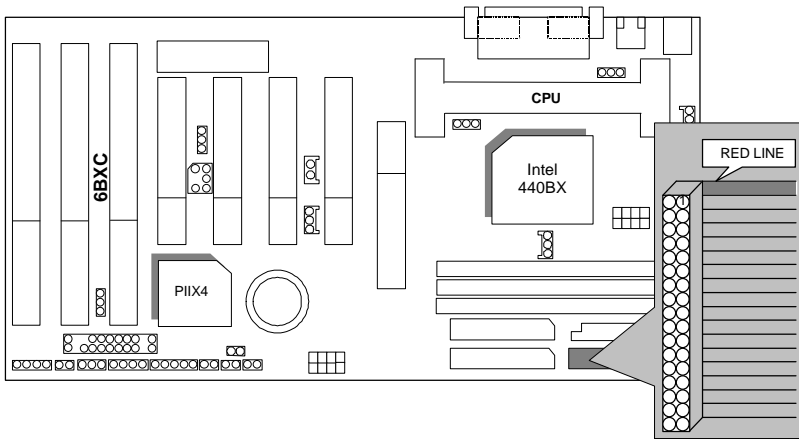

LPT PORT / COM A / COM B

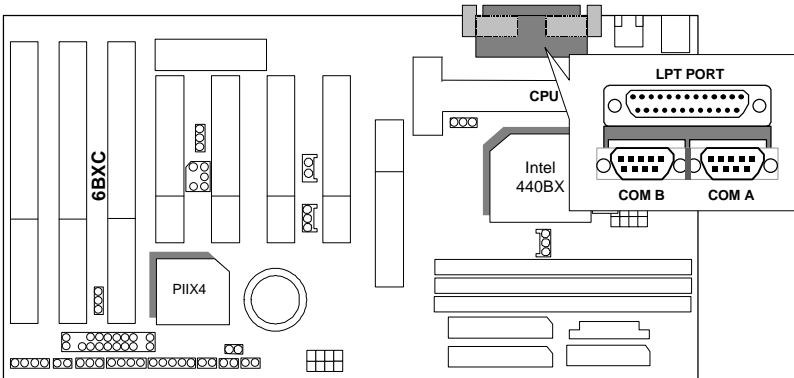

JP1 : Keyboard Power On Selection

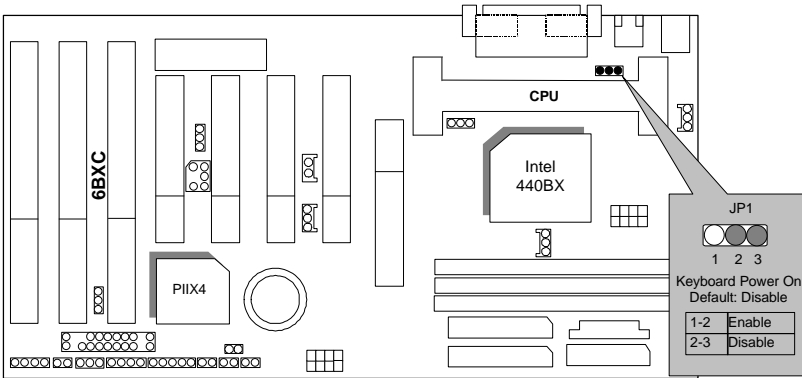

USB : USB Port

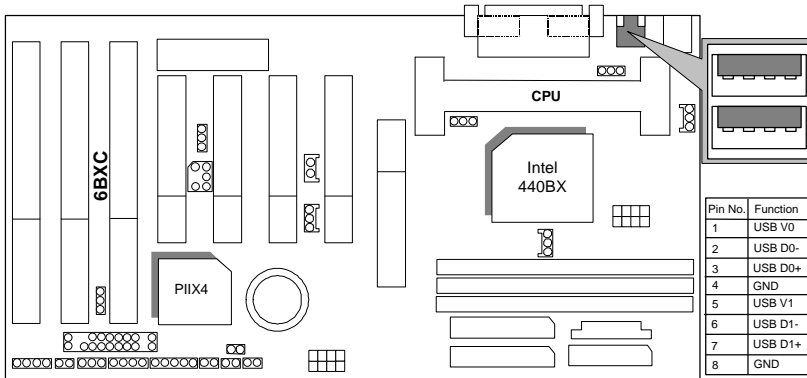

J15: System After AC Back

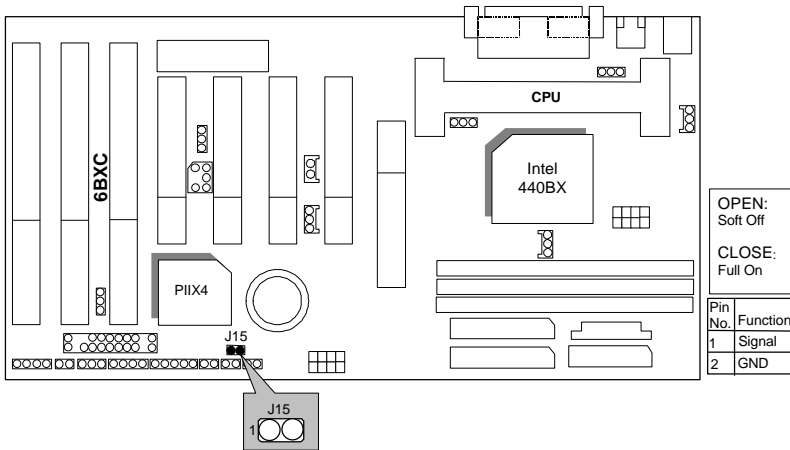



JP7: Wake On LAN

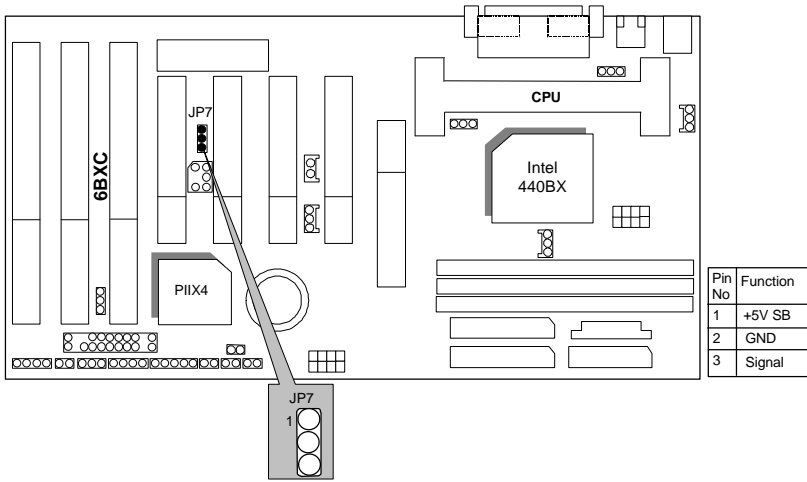

JP8:SB-LINK Creative PCI Sound Card Support

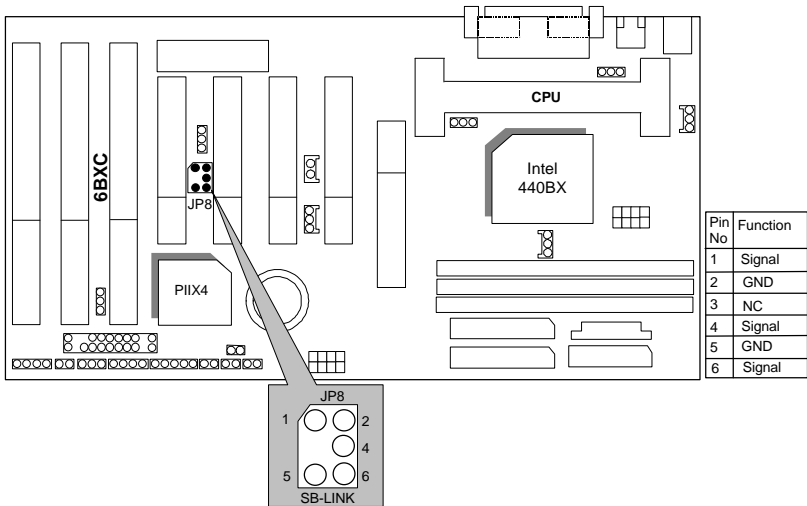

JP10 : System Acceleration

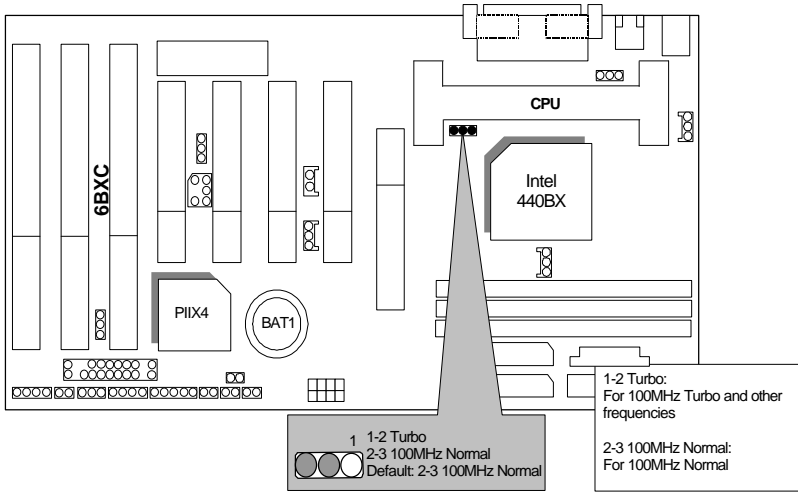

Power FAN : Power Fan Power Connector

(Only For PCB Rev:1.9 use)

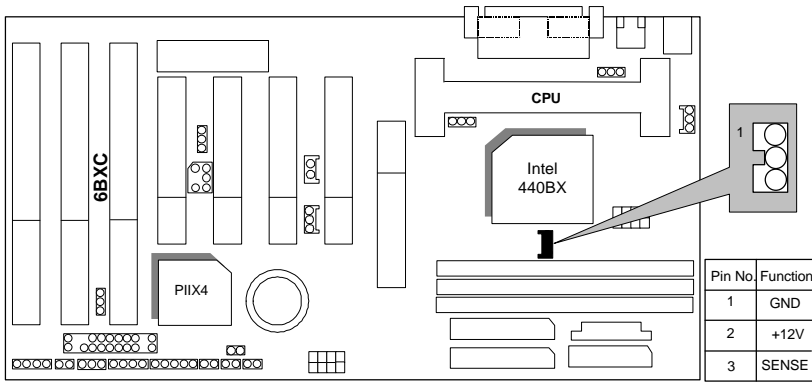

System FAN : System Fan Power Connector

(Only For PCB Rev:1.9 use)

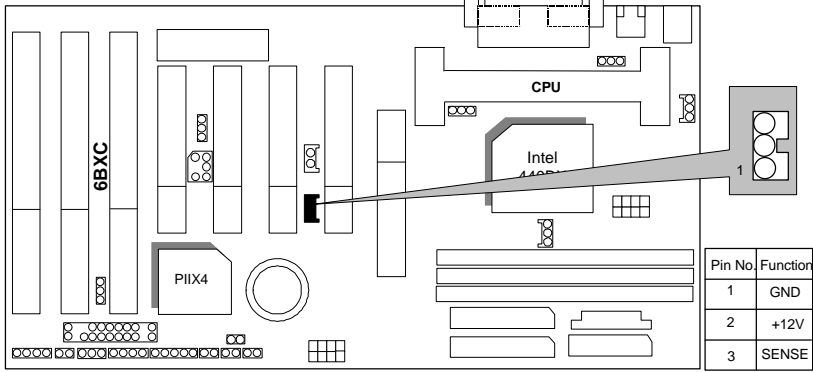

JP11: CLEAR CMOS FUNCTION (Only For PCB Rev:1.9 use)

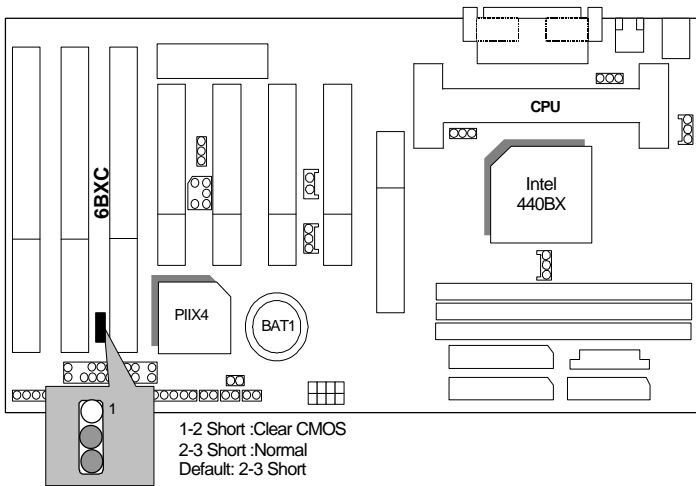

### Internal Ring Power On FUNCTION

(Only For PCB Rev:1.9 use)

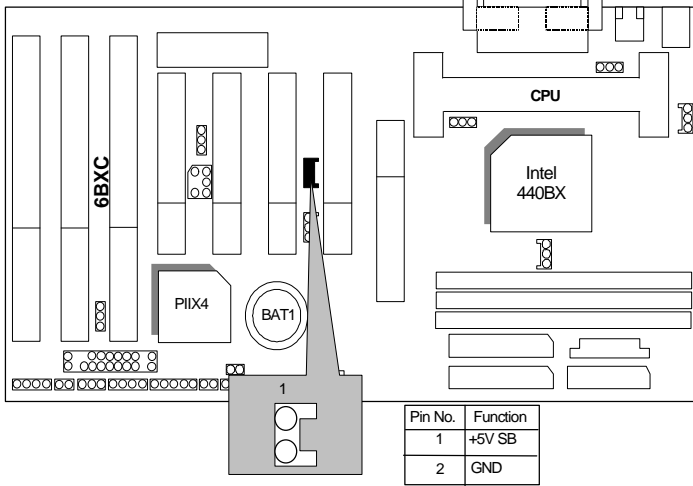

### BAT1 :BATTERY

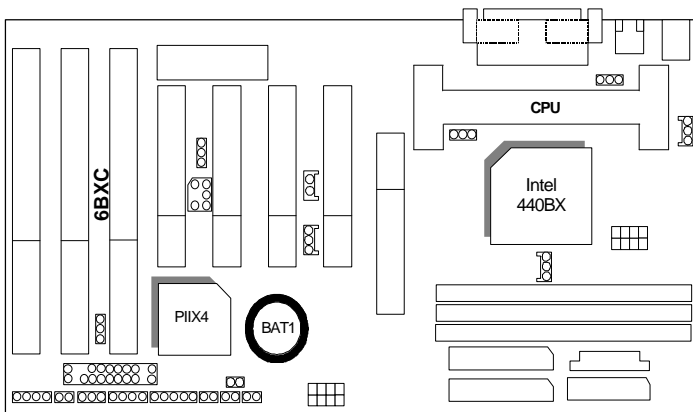

**Danger of explosion if battery is incorrectly replaced.**

**Replace only with the same or equivalent type recommended by the manufacturer.**

**Dispose of used batteries according to the manufacturer's instructions.**

### III. Top Performance Test Setting:

The following performance data list is the testing results of some popular benchmark testing programs.

Users have to modify the value for each item in chipset features as follow for top performance setting.

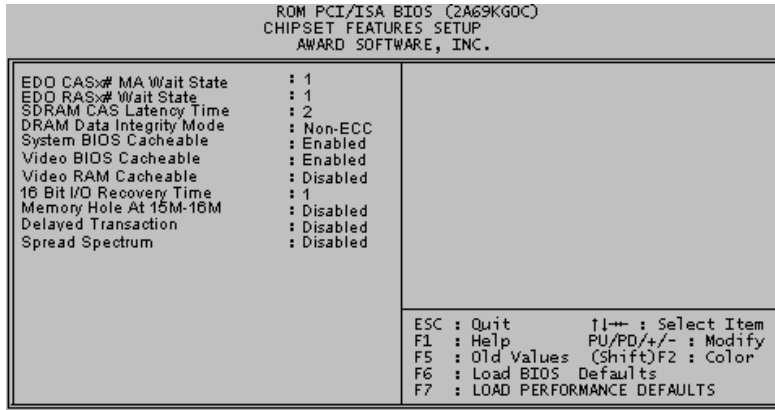

These data are just referred by users, and there is no responsibility for different testing data values gotten by users. (Different Hardware & Software configuration will result in different benchmark testing results.)

- CPU Pentium® II processor
- DRAM 128 MB SDRAM (SEC KM48S8030BT-GH)
- CACHE SIZE 512 KB included in CPU
- DISPLAY GA-601 AGP Display Card (4MB SGRAM)
- STORAGE Onboard IDE (IBM DHEA-38451)
- O.S. Windows NT™4.0
- DRIVER Display Driver at 1024 x 768 x 256 colors x 75Hz.  
TRIONES Bus Master IDE Driver 3.70

Processor	Intel Pentium® II	
	333MHz(66x5)	350MHz(100x3.5)
<b>Winbench98</b>		
CPU mark32	864	947
FPU Winmark	1720	1810
Business Disk	1850	1900
Hi-End Disk	4590	4690
Business Graphics	185	204
Hi-End Graphics	207	232
<b>Winstone98</b>		
Business	33.3	34.6
Hi-End	36.9	39.2