

**TABLE OF CONTENTS**

**1. INTRODUCTION**

1.1. PREFACE..... 1-1  
1.2. KEY FEATURES..... 1-1  
1.3. PERFORMANCE LIST..... 1-2  
1.4. BLOCK DIAGRAM ..... 1-3  
1.5. INTRODUCE THE Pentium® II Processor ..... 1-4  
1.6. What is AGP? ..... 1-6

**2. SPECIFICATION**

2.1. HARDWARE ..... 2-1  
2.2. SOFTWARE..... 2-2  
2.3. ENVIRONMENT..... 2-2

**3. HARDWARE INSTALLATION**

3.1. UNPACKING ..... 3-1  
3.2. MAINBOARD LAYOUT ..... 3-1  
3.3. QUICK REFERENCE FOR JUMPERS & CONNECTORS ..... 3-2  
3.4. DRAM INSTALLATION..... 3-5  
3.5. CPU SPEED SETUP ..... 3-6  
3.6. CMOS RTC & ISA CFG CMOS SRAM..... 3-7  
3.7. SPEAKER CONNECTOR INSTALLATION ..... 3-7  
3.8. HARDWARE RESET SWITCH CONNECTOR INSTALLATION..... 3-7  
3.9. POWER LED CONNECTOR INSTALLATION ..... 3-7

3.10. IDE & ATAPI DEVICE INSTALLATION.....3-7  
3.11. PERIPHERAL DEVICE INSTALLATION.....3-7  
3.12. KEYBOARD & PS/2 MOUSE INSTALLATION.....3-8  
3.13. SCSI DEVICE INSTALLATION .....3-8

**4. BIOS CONFIGURATION**

4.1. ENTERING SETUP .....4-1  
4.2. CONTROL KEYS .....4-1  
4.3. GETTING HELP.....4-2  
    4.3.1. Main Menu.....4-2  
    4.3.2. Status Page Setup Menu / Option Page Setup Menu.....4-2  
4.4. THE MAIN MENU.....4-2  
4.5. STANDARD CMOS SETUP MENU .....4-4  
4.6. BIOS FEATURES SETUP .....4-8  
4.7. CHIPSET FEATURES SETUP .....4-13  
4.8. POWER MANAGEMENT SETUP .....4-17  
4.9. PNP/PCI CONFIGURATION .....4-21  
4.10. LOAD BIOS DEFAULTS.....4-23  
4.11. LOAD PERFORMANCE DEFAULTS .....4-24  
4.12. INTEGRATED PERIPHERALS. ....4-25  
4.13. SUPERVISOR PASSWORD/USER PASSWORD .....4-30  
4.14. IDE HDD AUTO DETECTION.....4-31  
4.15. SAVE & EXIT SETUP .....4-32  
4.16. EXIT WITHOUT SAVING .....4-33

## 1. INTRODUCTION

### 1.1. PREFACE

Welcome to use the **6BXU** motherboard. It is a Pentium® II Processor based PC / AT compatible system with AGP / PCI / SCSI / ISA Bus, and has been designed to be the fastest PC / AT system. There are some new features allow you to operate the system with just the performance you want.

This manual also explains how to install the motherboard for operation, and how to set up your CMOS CONFIGURATION with BIOS SETUP program.

### 1.2. KEY FEATURES

- ❑ Intel Pentium® II Processor based PC / AT compatible mainboard.
- ❑ Slot 1 supports Pentium® II processor running at 200-633 MHz.
- ❑ Intel 440BX chipset, Supports AGP / SDRAM / Ultra DMA/33 IDE / Wake on LAN / Keyboard and PS/2 Mouse Power On / ACPI features.
- ❑ Supports Intel LDCM® Network Manageability.
- ❑ Supports 4xDIMMs using 3.3V SDRAM DIMM module.
- ❑ Supports 8 MB - 1 GB SDRAM memory on board.
- ❑ Supports ECC or Non-ECC type DRAM module.
- ❑ 1xAGP slot, 4xPCI Bus slots, 3xISA Bus slots.
- ❑ Supports 2 channels Ultra DMA/33 IDE ports for 4 IDE Devices.
- ❑ Supports both Ultra SCSI, Ultra Wide SCSI and Ultra II SCSI ports.
- ❑ Supports 2xCOM (16550), 1xLPT (EPP / ECP), 1x Floppy port.
- ❑ Supports 2xUSB ports, 1xPS/2 Mouse, 1xPS/2 Keyboard.
- ❑ Licensed AWARD BIOS, 2M bit FLASH RAM.
- ❑ 30.5 cm x 21 cm ATX SIZE form factor, 4 layers PCB.

### 1.3. PERFORMANCE LIST

The following performance data list is the testing results of some popular benchmark testing programs.

These data are just referred by users, and there is no responsibility for different testing data values gotten by users. (The different Hardware & Software configuration will result in different benchmark testing results.)

- CPU Pentium® II processor
- DRAM (32x4)MB SDRAM (SEC KM48S2020CT-G8)
- CACHE SIZE 512 KB included in CPU
- DISPLAY GA-601 AGP Display Card (4MB SGRAM)
- STORAGE Onboard Ultra Wide SCSI (IBM DRS-39130)
- O.S. Windows NT™ 4.0
- DRIVER Display Driver at 1024 x 768 x 256 colors x 75Hz.  
Adaptec AIC-7890 SCSI Driver

Processor	Intel Pentium® II	
	450MHz(100x4.5)	333MHz(66x5)
<b>Winbench98</b>		
CPU mark32	1100	843
FPU Winmark	2290	1720
Business Disk	1930	1840
Hi-End Disk	4580	4460
Business Graphics	201	163
Hi-End Graphics	238	171
<b>Winstone98</b>		
Business	36	30.8
Hi-End	39.4	32.8

1.4. BLOCK DIAGRAM

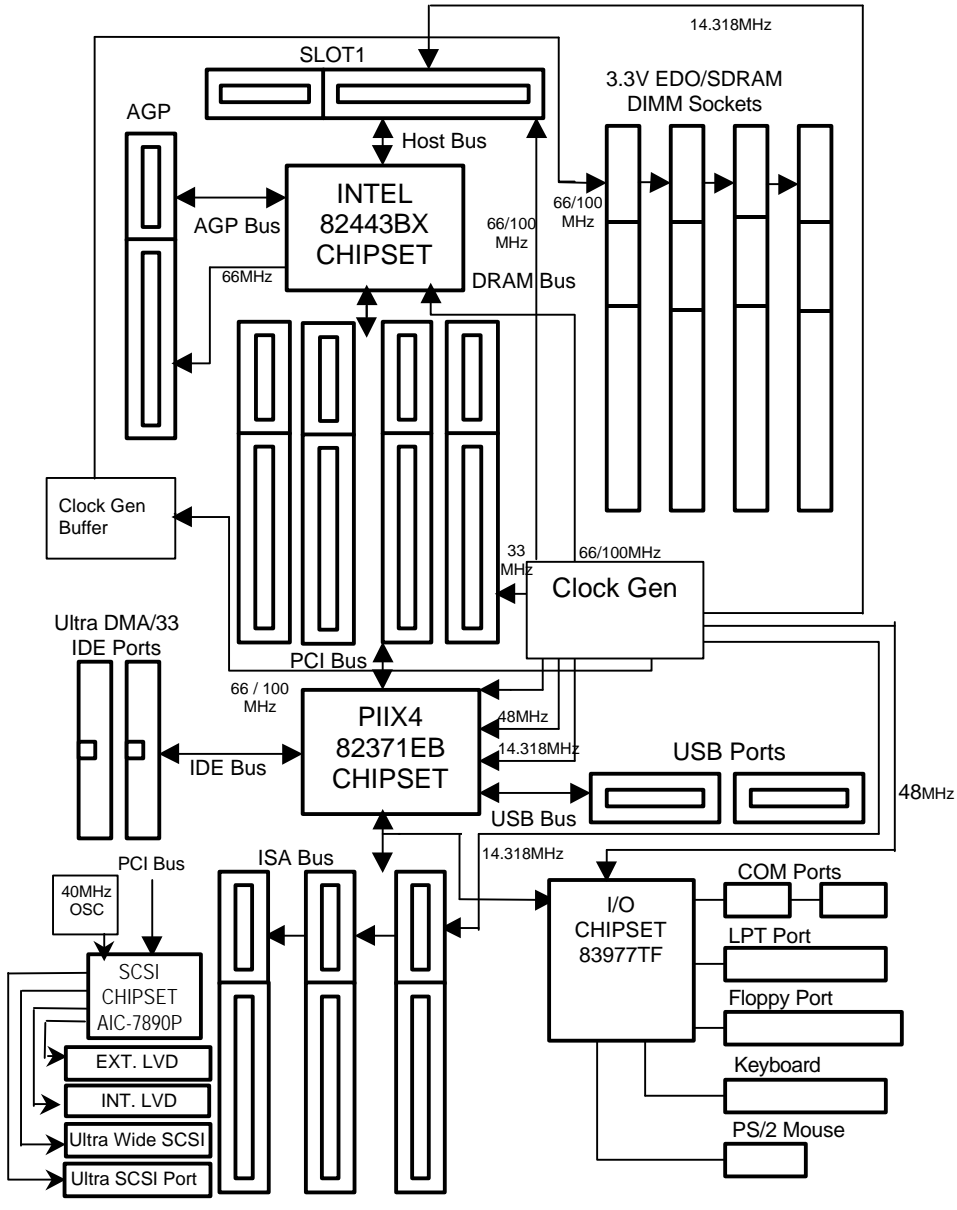

### 1.5. INTRODUCE THE Pentium® II Processor & AGP



Figure 1:Retention Mechanism & attach Mount



Figure 2:OEM Pentium® II Processor

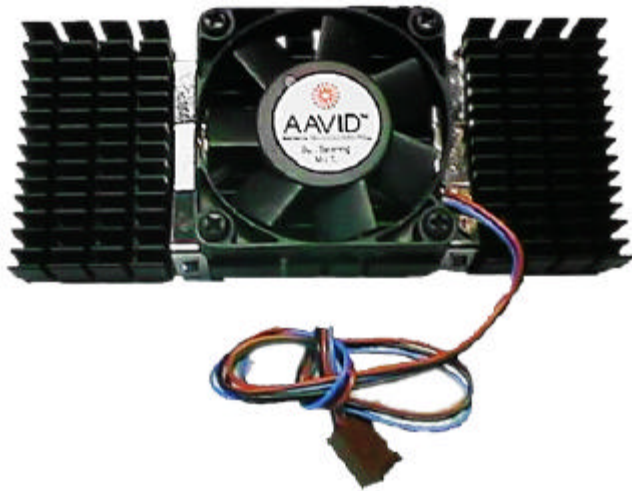

Figure 3:Heatsink / FAN & Heat sink support for OEM Pentium® II Processor

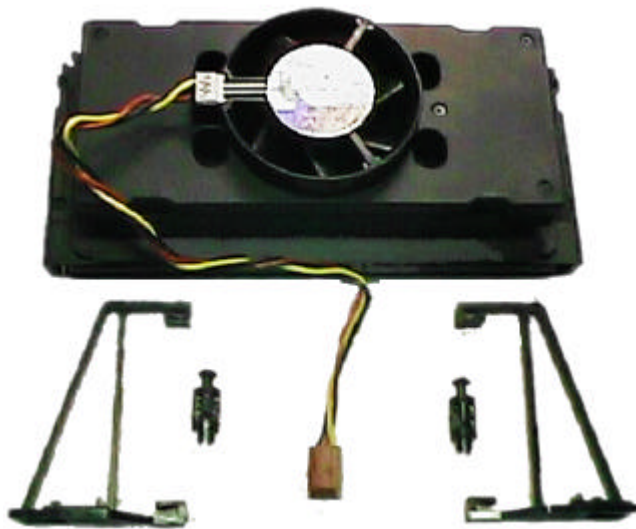

Figure 4:Boxed Pentium® II Processor & Heat sink support

## 1.6 What is AGP?

The Accelerated Graphics Port (AGP) is a new port on the Host-To-PCI bridge device that supports an AGP port. The main purpose of the AGP port is to provide fast access to system memory.

The AGP port can be used either as fast PCI port (32-bits at 66MHz vs. 32-bits at 33MHz) or as an AGP port which supports 2x data-rate, a read queue, and side band addressing. When the 2x-data rate is used the port can transmit data at 533MB/sec ( $66.6 \times 2 \times 4$ ). The read-queue can be used to pipeline reads – removing the effects of the reads-latency. Side band addressing can be used to transmit the data address on a separate line in order to speed up the transaction.



## 2. SPECIFICATION

### 2.1. HARDWARE

- CPU
  - Pentium® II processor 200 – 633 MHz.
  - 242 pins 66/100MHz slot1 on board.
- PROTECTION
  - Speaker Alarm when detect "CPU FAN Failure" or "CPU Overheat".
  - Automatically slow down CPU speed when "CPU Overheat".
  - Intel LDCM® supported.
  - H/W monitor power status ( $\pm 5V$ ,  $\pm 12V$ , 5V SB, VGTL , CPU voltage & CMOS battery voltage).(Optional)
- SPEED
  - 66/100 MHz system speed.
  - 66 MHz AGP bus speed. (2X mode 133MHz)
  - 33 MHz PCI-Bus speed.
  - 8 MHz AT bus speed.
- DRAM MEMORY
  - 4 banks 168 pins DIMM module sockets on board.
  - Use 8 / 16 / 32 / 64 / 128 / 256 MB DIMM module DRAM.
  - 8 ~ 1 GB SDRAM.
  - Supports 3.3V SDRAM.
  - Supports ECC or Non-ECC type DRAM.
- CACHE MEMORY
  - 32 KB 1st cache memory included in CPU.
  - 256KB/512 KB 2nd cache in CPU.
  - Supports DIB speed mode for L2 Cache.
- I/O BUS SLOTS
  - 4 33MHz Master / Slave PCI-BUS.
  - 3 8MHz 16 bits ISA BUS.
  - 1 66MHz / 133MHz AGP bus.
- IDE PORTS
  - 2 Ultra DMA/33 Bus Master IDE channels on board.(Using IRQ14,15)

- Support Mode 3,4 IDE & ATAPI CD – ROM.
- SCSI PORTS
  - Supports 1 Ultra Wide SCSI port.
  - Supports 1 Ultra SCSI port.
  - Supports 2 Ultra II SCSI port.
- I/O PORTS
  - Supports 2 16550 COM ports.
  - Supports 1 EPP/ECP LPT port.
  - Supports 1 Floppy port.
  - Supports 2 USB ports.
  - Supports PS/2 Mouse & Keyboard.
- GREEN FUNCTION
  - Suspend mode support.
  - Green switch & ACPI LED support.
  - IDE & Display power down support.
  - Monitor all IRQ / DMA / Display / I/O events.
- BIOS
  - 2M bits FLASH RAM.
  - Supports Plug & Play, DMI Function.
- DIMENSION
  - ATX Form Factor, 4 layers PCB.

## 2.2. SOFTWARE

- DRIVER
  - Intel LDCM® (optional.)
  - Health monitor Utility.
  - Bus Master IDE Driver.
  - Adaptec SCSI Driver.
- BIOS
  - Licensed AWARD BIOS.
  - AT CMOS Setup, BIOS / Chipset Setup, Green Setup, Hard Disk Utility included.
  - Monitor Health status.
- O.S.
  - Operation with MS-DOS®, Windows®95, WINDOWS™ NT, OS/2, NOVELL and SCO UNIX.

## 2.3. ENVIRONMENT

- Ambient Temp. – 0°C to +50°C (Operating).
- Relative Hum. – 0 to +85% (Operating).
- Altitude – 0 to 10,000 feet (Operating).
- Vibration – 0 to 1,000 Hz.

- Electricity – 4.9 V to 5.2 V. (Max. 20A current at 5V.)



## 3. HARDWARE INSTALLATION

### 3.1. UNPACKING

The mainboard package should contain the following:

- The **6BXU** mainboard.
- The Retention Mechanism & Attach Mount
- USER'S MANUALS for mainboard & SCSI device.
- Cable set for IDE, Floppy, SCSI & I/O devices.
- Diskettes and CD for Mainboard Utility.
- External LVD port adapter.

The mainboard contains sensitive electric components, which can be easily damaged by static electricity, so the mainboard should be left in its original packing until it is installed.

Unpacking and installation should be done on a grounded anti-static mat. The operator should be wearing an anti static wristband, grounded at the same point as the anti-static mat.

Inspect the mainboard carton for obvious damage. Shipping and handling may cause damage to your board. Be sure there are no shipping and handling damages on the board before proceeding.

After opening the mainboard carton, extract the system board and place it only on a grounded anti-static surface component side up. Again inspect the board for damage. Press down on all of the socket IC's to make sure that they are properly seated. Do this only on with the board placed on a firm flat surface.

● **DO NOT APPLY POWER TO THE BOARD IF IT HAS BEEN DAMAGED.**

### 3.2. MAINBOARD LAYOUT

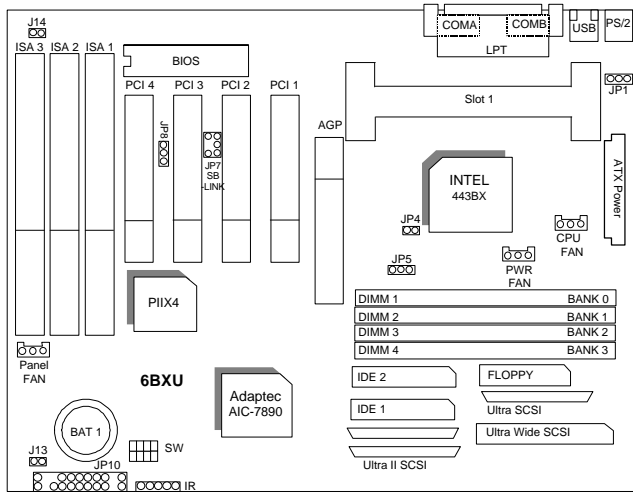

<Figure 3.1>

### 3.3. QUICK REFERENCE FOR JUMPERS & CONNECTORS

◆ I/O Ports Connector	
USB	USB port.
Ultra SCSI	Ultra SCSI port
Ultra Wide SCSI	Ultra Wide SCSI port
Ultra II SCSI	Ultra II SCSI port
IDE1	For Primary IDE port.
IDE2	For Secondary IDE port.
PS/2	For PS/2 Keyboard/Mouse port.
Floppy	For Floppy port
COM B	For Serial port2 (COM B).
COM A	For Serial port1 (COM A).
LPT	For LPT port.

◆ Slot 1	
For Pentium® II processor installed	

◆ IR : INFRARED Connector (IR) -- Function Option	
Pin No.	Function

1	IR Data Output
2	GND
3	IR Data Input
4	Signal
5	POWER (+)

◆ CPU FAN : CPU cooling FAN Power Connector	
Pin No.	Function
1	GND.
2	+12V
3	SENSE

◆ PWR FAN : Power FAN Connector	
Pin No.	Function
1	GND.
2	+12V
3	SENSE

◆ Panel FAN : Panel FAN Connector	
Pin No.	Function
1	GND.
2	+12V
3	SENSE

◆ J13 : System Power On After Ac Back	
Pin No.	Function
1	Signal
2	GND

◆ JP1 : Keyboard Power On Selection	
Pin No.	Function
1-2	Enabled Keyboard Power On
2-3	Disabled Keyboard Power On

◆ JP7:SB-LINK For PCI Audio / Sound Card use only	
Pin No.	Function

1	Signal
2	GND
3	NC
4	Signal
5	GND
6	Signal

◆ JP8 : Wake on LAN

Pin No.	Function
1	+5V SB
2	GND
3	Signal

◆ J14 : Case Open(Please remove shunted jumper before use.)

Pin No.	Function
1	Signal
2	GND

**JP10 : 2\*11 PIN Jumper**

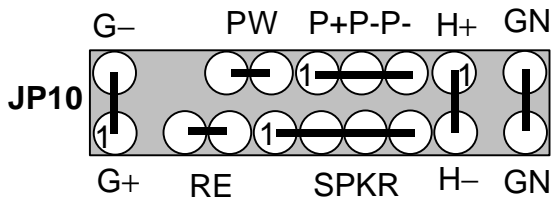

**PW: Soft Power Connector**



Open: Normal Operation  
Short: Power On/Off

**RE: Reset Switch**



Open: Normal Operation  
Short: For Hardware Reset System

**P+P-P-: Power LED**



PIN 1 : anode (+)



PIN 2 : cathode (-)

PIN 3 : cathode (-)

**SPKR : Speaker Connector**

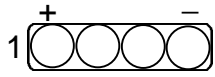

PIN 1 : VCC

PIN 2 : NC

PIN 3 : NC

PIN 4 : Data

**H+H- : IDE Hard Disk Active LED**



PIN 1: LED anode (+)

PIN 2: LED cathode (-)

**GN: Green Function Switch**



Open : Normal operation

Short : Entering Green Mode

**G- G+: Green LED**



PIN 1 : LED anode (+)

PIN 2 : LED cathode (-)

**3.4. DRAM INSTALLATION**



The mainboard can be installed with 8 / 16 / 32 / 64 / 128 / 256 MB 168 pins DIMM module DRAM, and the DRAM speed must be 50 or 60 ns for EDO & 67~100 MHz for SDRAM. The DRAM memory system on mainboard consists of bank 0, 1, 2 & bank 3.

Since 168 pins DIMM module is 64 bits width, using 1 PCS which can match a 64 bits system. The total memory size is 8 MB ~ 1 GB EDO or SDRAM. The DRAM installation position refer to Figure 3.1, and notice the Pin 1 of DIMM module must match with the Pin 1 of DIMM socket. Insert the DRAM DIMM module into the DIMM socket at Vertical angle. If there is a wrong direction of Pin 1, the DRAM DIMM module couldn't be inserted into socket completely.

**3.5. CPU SPEED SETUP**

The system bus speed can be set to 66MHz or 100MHz from the jumper (**JP5**). The user can change the DIP SWITCH (**SW**) selection to set up the CPU speed for different processors. The CPU speed must match with the frequency RATIO and Front Side Bus (FSB) speed. It will cause system hanging up if the frequency RATIO and FSB Speed do not match with the CPU.

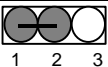
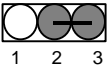
● **JP5** (Select the system speed between 66 Hz and 100MHz)

<b>1-2 Close</b>		<b>Set system speed to 66MHz</b> - system always run at 66MHz FSB (Front Side Bus).
<b>2-3 Close</b>		<b>Set system speed to Auto</b> - auto detect system speed (66/ 100MHz FSB)
<b>1-2-3 Open</b>		<b>Set system speed to 100MHz</b> - system always run at 100MHz FSB (Front Side Bus).

DIP SWITCH (SW)				FREQ. RATIO	EXT.CLK. MHz	INT.CLK. MHz	CPU Type
1	2	3	4				
OFF	OFF	ON	ON	3.5	<b>66</b>	233	Pentium® II 233 MHz
ON	ON	OFF	ON	4	<b>66</b>	266	Pentium® II 266 MHz
OFF	ON	OFF	ON	4.5	<b>66</b>	300	Pentium® II 300 MHz
ON	OFF	OFF	ON	5	<b>66</b>	333	Pentium® II 333 MHz
OFF	OFF	OFF	ON	5.5	<b>66</b>	366	Pentium® II 366 MHz
ON	OFF	ON	ON	3	<b>100</b>	300	Pentium® II 300 MHz
OFF	OFF	ON	ON	3.5	<b>100</b>	350	Pentium® II 350 MHz
ON	ON	OFF	ON	4	<b>100</b>	400	Pentium® II 400 MHz
OFF	ON	OFF	ON	4.5	<b>100</b>	450	Pentium® II 450 MHz
ON	OFF	OFF	ON	5	<b>100</b>	500	Pentium® II 500 MHz
OFF	OFF	OFF	ON	5.5	<b>100</b>	550	Pentium® II 550 MHz

● The CPU is a sensitive electric component and it can be easily damaged by static electricity, so users must keep it away from metal surface when the CPU is installed onto main board.

### 3.6. CMOS RTC & ISA CFG CMOS SRAM

There're RTC & CMOS SRAM on board; they have a power supply from external battery to keep the DATA inviolate & effective. The RTC is a REAL-TIME CLOCK device, which provides the DATE & TIME to system. The CMOS SRAM is used for keeping the information of system configuration, so the system can automatically boot OS every time. Since the lifetime of internal battery is 5 years, the user can change a new Battery to replace old one after it cannot work.

### **3.7. SPEAKER CONNECTOR INSTALLATION**

There is a speaker in AT system for sound purpose. The 4 - Pins connector **SPKR** is used to connect speaker. Anode connects +, Cathode connects –.

### **3.8. HARDWARE RESET SWITCH CONNECTOR INSTALLATION**

The RESET switch on panel provides users with HARDWARE RESET function. The system will do a cold start after the RESET switch is pushed and released by user. The RESET switch is a 2 PIN connector and should be installed to **RE** on mainboard.

### **3.9. POWER LED CONNECTOR INSTALLATION**

System has power LED lamp on the panel of case. The power LED will light on off or flash to indicate which step on the system. The connector should be connected to PWR of mainboard in correct direction.

### **3.10. IDE & ATAPI DEVICE INSTALLATION**

There are two-Enhanced PCI IDE ports (**IDE1, IDE2**) on board, which following ATAPI standard SPEC. Any one IDE port can connected to two ATAPI devices (IDE Hard Disk, CD-ROM & Tape Driver), so total four ATAPI devices can exist in a system. The **HD** is the active LED port for ATAPI devices.

### **3.11. PERIPHERAL DEVICE INSTALLATION**

After the I/O device installation and jumpers setup, the mainboard can be mounted into the case and fixed by screw. To complete the mainboard installation, the peripheral device could be installed now. The basic system needs a display interface card. If the PCI - Bus device is to be installed in the system, any one of four PCI - Bus slots can be used.

### **3.12. KEYBOARD & PS/2 MOUSE INSTALLATION**

The main board supports PS/2 Mouse (**J1**). The BIOS will auto detect whether the PS/2 Mouse is installed or not & assign IRQ12 for PS/2 Mouse port if it is installed. After installing the peripheral device, the user should check everything again, and prepare to power-on the system.

### 3.13. SCSI DEVICE INSTALLATION

There are four SCSI ports on board, One is 8bit SCSI port for ULTRA SCSI device, the other one for Ultra wide SCSI , another is for Ultra II SCSI. And total 15 SCSI devices can exist in a system.

Single Ended and LVD Terminator Control are controlled by BIOS Setup (In the INTEGRATED PERIPHERALS Setup page.)

#### Terminator ON/OFF rules

**State 1. Ultra or Ultra wide SCSI Devices connecting to SE Port :**

**CASE 1: Single Ended Termination: Both  
LVD Terminator Control : Enabled**

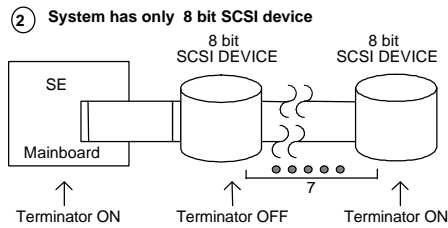
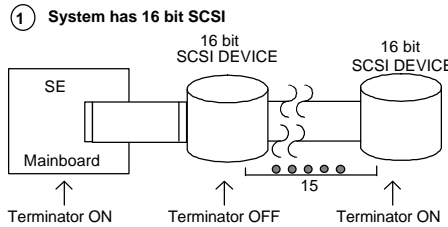

③ System has EXT. SCSI port but has not INT. SCSI device

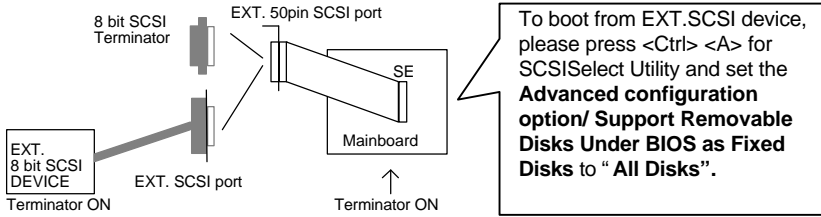

**CASE 2: Single Ended Termination: High Byte LVD Terminator Control : Enabled**

① System has 16 bit & 8 bit SCSI device

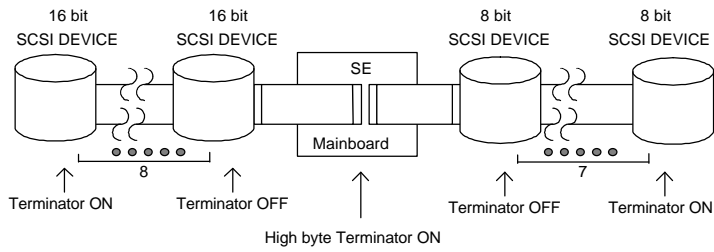

② System has 8 bit EXT. SCSI port & 16 bit INT. SCSI device

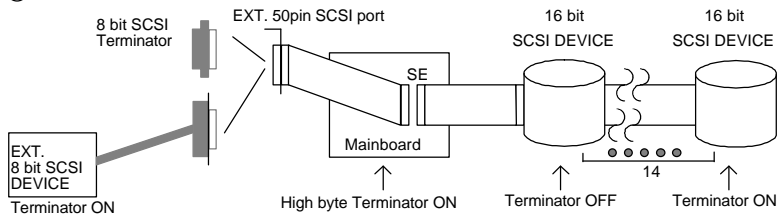

**State 2. LVD (Ultra II) SCSI Devices connecting to LVD Channel :**

**CASE 1: Single Ended Termination : Both  
LVD Terminator Control : Enabled**

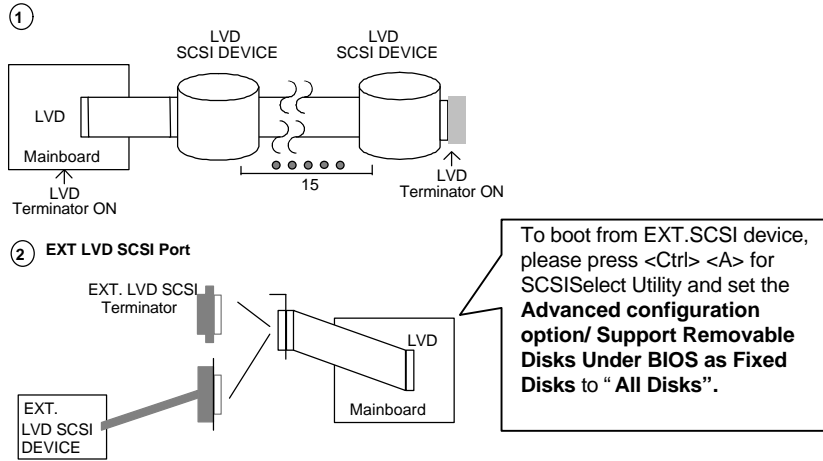

**CASE 2: Single Ended Termination : Both  
LVD Terminator Control : Disabled**

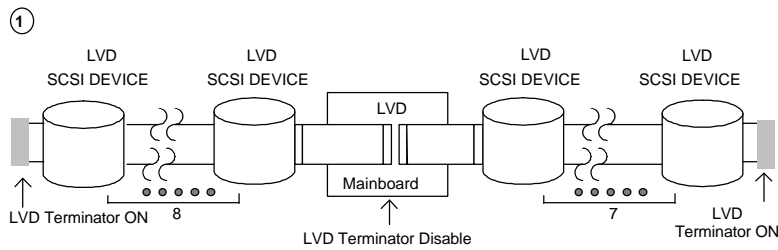

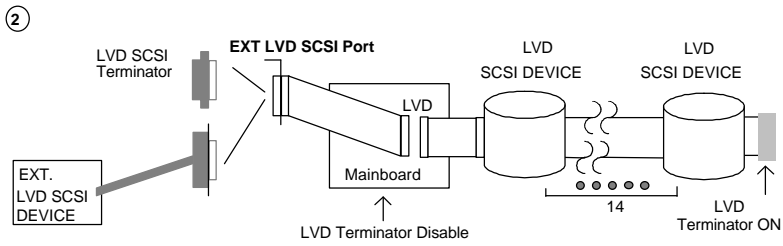

**State 3. Ultra or Ultra wide Device connecting to SE port**

**LVD (Ultra II) device connecting to LVD port**

**CASE 1: Single Ended Termination : Both  
LVD Terminator Control : Enabled**

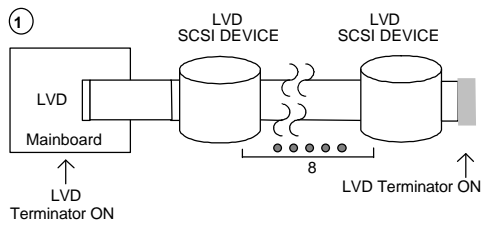

**System has 16 bit SCSI**

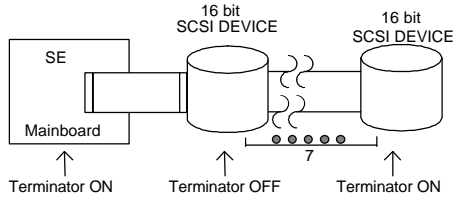

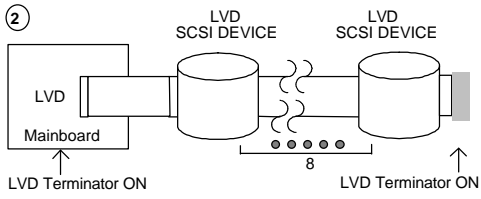

System has only 8 bit SCSI device

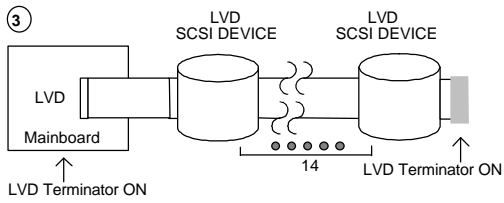
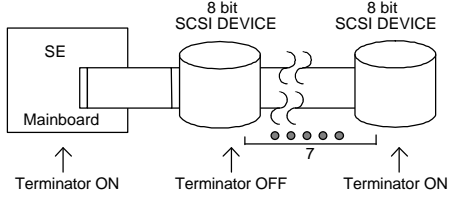

System has EXT. SCSI port but has not INT. SCSI device

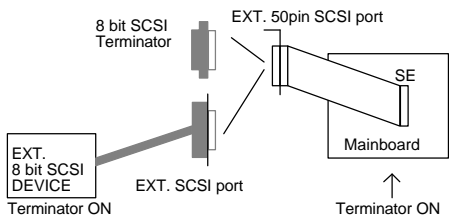

To boot from EXT.SCSI device, please press <Ctrl> <A> for SCSISelect Utility and set the **Advanced configuration option/ Support Removable Disks Under BIOS as Fixed Disks** to "All Disks".



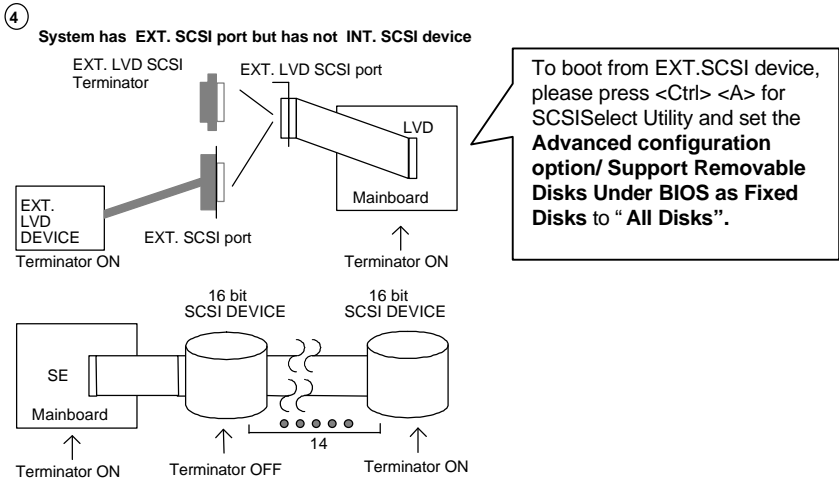

**CASE 2: Single Ended Termination : High Byte  
LVD Terminator Control : Enabled**

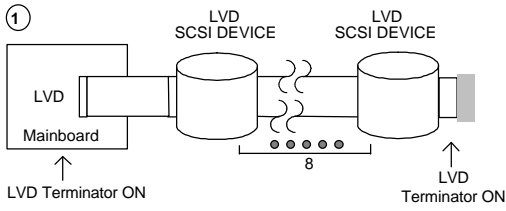

System has 16 bit & 8 bit SCSI device

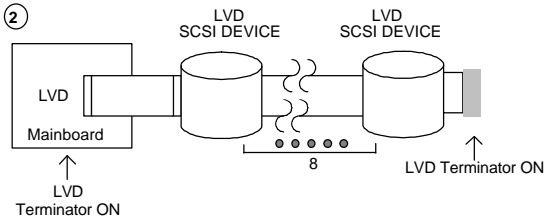
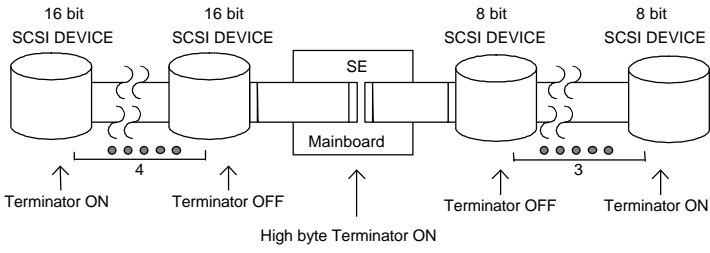

System has 8 bit EXT. SCSI port & 16 bit INT. SCSI device

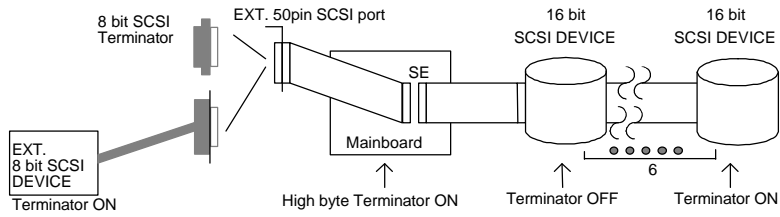

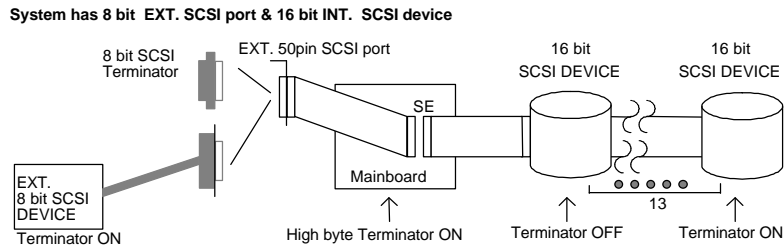
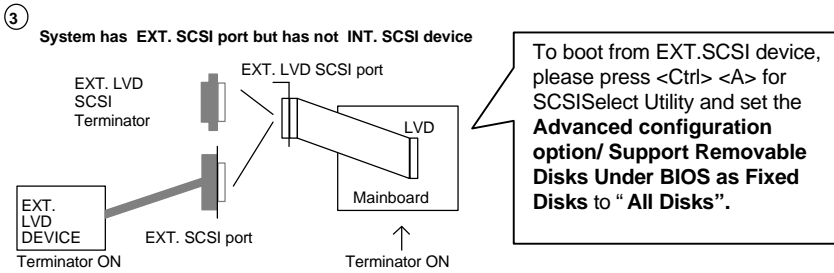

**CASE 3: Single Ended Termination : Both LVD Terminator Control : Disable**

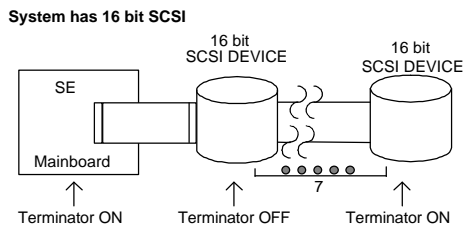
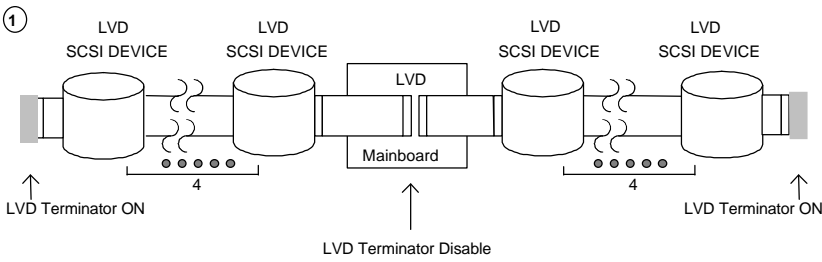

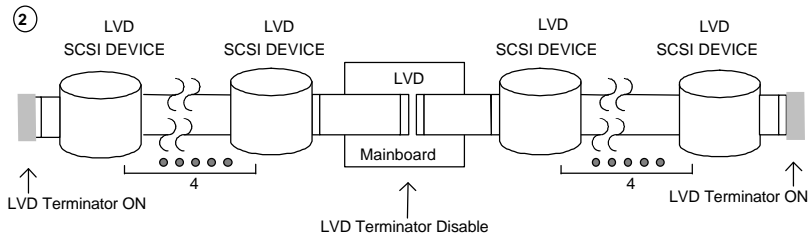

System has only 8 bit SCSI device

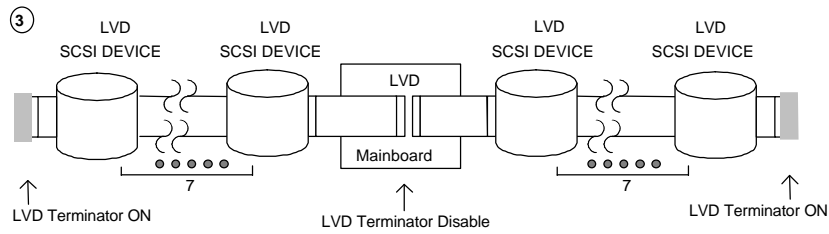
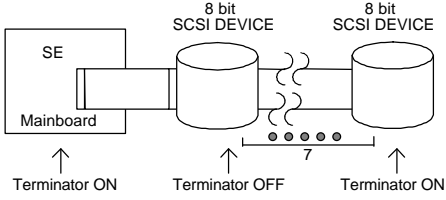

System has EXT. SCSI port but has not INT. SCSI device

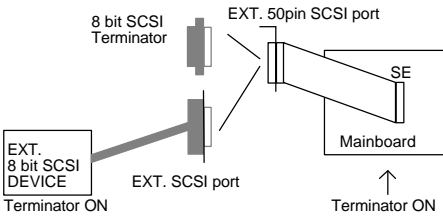

To boot from EXT.SCSI device, please press <Ctrl> <A> for SCSISelect Utility and set the **Advanced configuration option/ Support Removable Disks Under BIOS as Fixed Disks** to "All Disks".

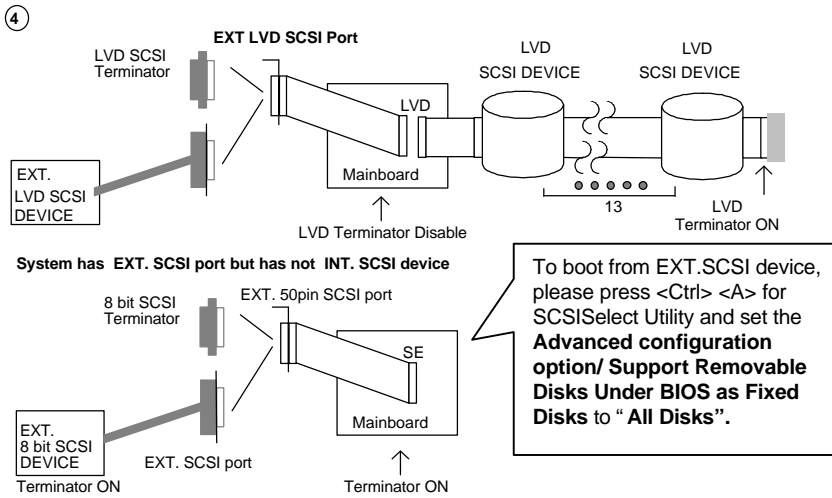

**CASE 4: Single Ended Termination : High Byte**  
**LVD Terminator Control : Disable**

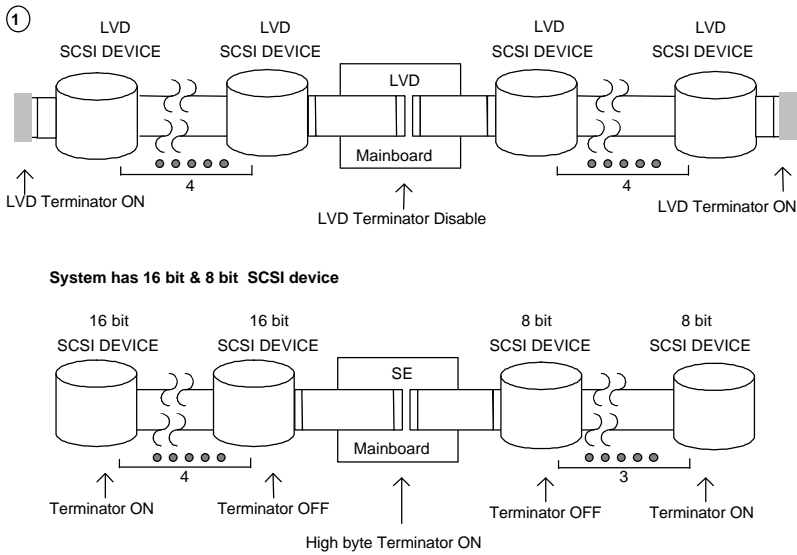

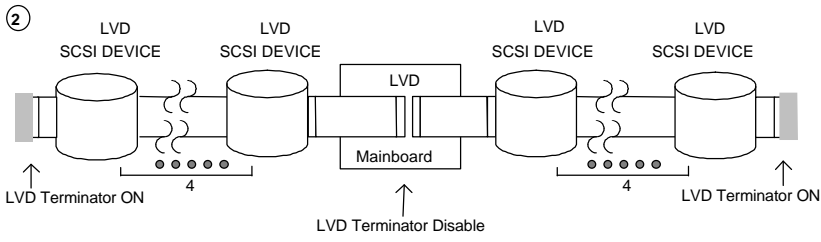

System has 8 bit EXT. SCSI port & 16 bit INT. SCSI device

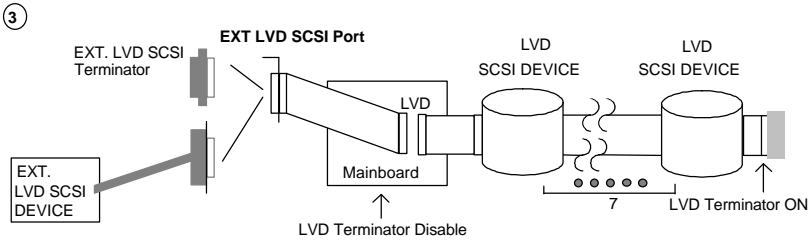
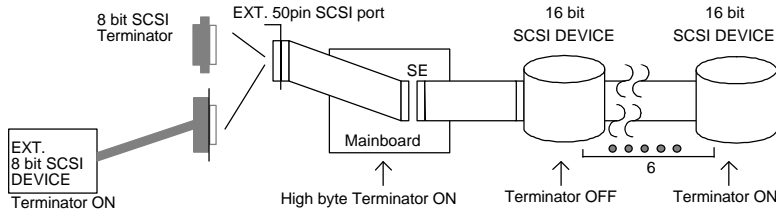

System has 8 bit EXT. SCSI port & 16 bit INT. SCSI device

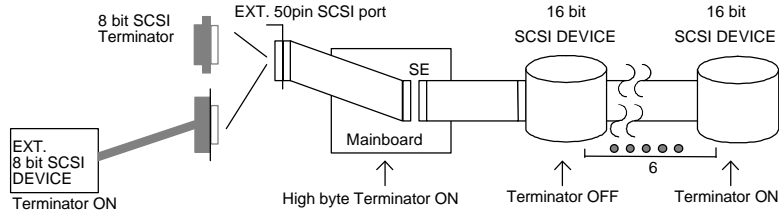

## **Adaptec 78xx Family Driver Installation for Windows NT CDROM Boot**

### **Installing Windows NT V4.0**

The following instructions explain how to install the Adaptec 7800 Family Manager, while installing Windows NT V4.0 from CDROM Boot.

1. Start your system with the Windows NT Boot CD in the CDROM drive.
2. During the initial stages of the boot process as soon as you see blue screen of "Windows NT Setup" then press F6.
3. Press S again to specify an additional device.
4. Select "Other" and feed it the Adaptec 7800 Family Manager diskette for WinNT 3.5x, 4.0/d2.11 then press Enter.
5. For Ultra2 host adapters(AIC-7890/AIC-7896), Select the "Adaptec AHA-294xU2/295xU2/AIC-789X PCI Ultra2 SCSI Controller(NT 4.0)" and press ENTER.
6. Then follow the normal Windows NT installation procedure to complete the setup processor.

