

FCC Compliance Statement:

<p>DECLARATION OF CONFORMITY Per FCC Part 2 Section 2.107(a)</p> <p>FC</p> <p>Responsible Party Name: G.B.T. INC.</p> <p>Address: 18316 Valley Blvd., Suite#A LA Puente, CA 91744</p> <p>Phone/Fax No: (818) 854-9338 / (818) 854-9339</p> <p>hereby declares that the product</p> <p>Product Name: Mother Board</p> <p>Model Number: GA-6CXC</p> <p>Conforms to the following specifications:</p> <p>FCC Part 15, Subpart B, Section 15.107(a) and Section 15.109(a), Class B Digital Device.</p> <p>Supplementary Information:</p> <p>This device complies with part 15 of the FCC Rules. Operation is subject to the following two conditions: (1) This device may not cause harmful and (2) this device must accept any interference received, including that may cause undesired operation.</p> <p>Representative Person's Name: <u>ERIC LIU</u></p> <p>Signature: <u>Eric Lu</u></p> <p>Date: <u>Dec.03,1999</u></p>
--

This equipment has been tested and found to comply with limits for a Class B digital device , pursuant to Part 15 of the FCC rules. These limits are designed to provide reasonable protection against harmful interference in residential installations. This equipment generates, uses, and can radiate radio frequency energy, and if not installed and used in accordance with the instructions, may cause harmful interference to radio communications. However, there is no guarantee that interference will not occur in a particular installation. If this equipment does cause interference to radio or television equipment

reception, which can be determined by turning the equipment off and on, the user is encouraged to try to correct the interference by one or more of the following measures:

- Reorient or relocate the receiving antenna
- Move the equipment away from the receiver
- Plug the equipment into an outlet on a circuit different from that to which the receiver is connected
- Consult the dealer or an experienced radio/television technician for additional suggestions

You are cautioned that any change or modifications to the equipment not expressly approve by the party responsible for compliance could void Your authority to operate such equipment.

This device complies with Part 15 of the FCC Rules. Operation is subjected to the following two conditions 1) this device may not cause harmful interference and 2) this device must accept any interference received, including interference that may cause undesired operation.

Declaration of Conformity

We, Manufacturer/Importer
(full address)

G.B.T. Technology Trading GmbH
Ausschlagler Weg 41, 1F, 20537 Hamburg, Germany

declare that the product
(description of the apparatus, system, installation to which it refers)

Mother Board
GA-6CXC

is in conformity with
(reference to the specification under which conformity is declared)
in accordance with 89/336 EEC-EMC Directive

- | | | | |
|---|--|--|--|
| <input type="checkbox"/> EN 55011 | Limits and methods of measurement of radio disturbance characteristics of industrial, scientific and medical (ISM high frequency equipment | <input checked="" type="checkbox"/> EN 61000-3-2*
<input checked="" type="checkbox"/> EN60555-2 | Disturbances in supply systems caused by household appliances and similar electrical equipment "Harmonics" |
| <input type="checkbox"/> EN55013 | Limits and methods of measurement of radio disturbance characteristics of broadcast receivers and associated equipment | <input type="checkbox"/> EN61000-3-3*
<input checked="" type="checkbox"/> EN60555-3 | Disturbances in supply systems caused by household appliances and similar electrical equipment "Voltage fluctuations" |
| <input type="checkbox"/> EN 55014 | Limits and methods of measurement of radio disturbance characteristics of household electrical appliances, portable tools and similar electrical apparatus | <input checked="" type="checkbox"/> EN 50081-1
<input checked="" type="checkbox"/> EN 50082-1 | Generic emission standard Part 1: Residual, commercial and light industry
Generic immunity standard Part 1: Residual, commercial and light industry |
| <input type="checkbox"/> EN 55015 | Limits and methods of measurement of radio disturbance characteristics of fluorescent lamps and luminaries | <input type="checkbox"/> EN 55081-2 | Generic emission standard Part 2: Industrial environment |
| <input type="checkbox"/> EN 55020 | Immunity from radio interference of broadcast receivers and associated equipment | <input type="checkbox"/> EN 55082-2 | Generic immunity standard Part 2: Industrial environment |
| <input checked="" type="checkbox"/> EN 55022 | Limits and methods of measurement of radio disturbance characteristics of information technology equipment | <input type="checkbox"/> ENV 55104 | Immunity requirements for household appliances tools and similar apparatus |
| <input type="checkbox"/> DIN VDE 0855
<input type="checkbox"/> part 10
<input type="checkbox"/> part 12 | Cabled distribution systems; Equipment for receiving and/or distribution from sound and television signals | <input type="checkbox"/> EN 50091- 2 | EMC requirements for uninterruptible power systems (UPS) |

CE marking



(EC conformity marking)

The manufacturer also declares the conformity of above mentioned product with the actual required safety standards in accordance with LVD 73/23 EEC

- | | | | |
|-----------------------------------|---|-------------------------------------|---|
| <input type="checkbox"/> EN 60065 | Safety requirements for mains operated electronic and related apparatus for household and similar general use | <input type="checkbox"/> EN 60950 | Safety for information technology equipment including electrical business equipment |
| <input type="checkbox"/> EN 60335 | Safety of household and similar electrical appliances | <input type="checkbox"/> EN 50091-1 | General and Safety requirements for uninterruptible power systems (UPS) |

Manufacturer/Importer

Signature : Rex Lin

Name : Rex Lin

(Stamp)

Date : Dec. 03, 1999

6CXC/6CXC-1
Pentium® II / III Processor
Motherboard

USER'S MANUAL

How this manual is organized

This manual is divided into the following sections:

1) Revision List	Manual revision information
2) Item Checklist	Product item list
3) Features	Product information & specification
4) Hardware Setup	Instructions on setting up the motherboard
5) Performance & Block Diagram	Product performance & block diagram
6) Suspend to RAM & Dual BIOS	Instructions STR installation & Dual BIOS
7) BIOS Setup	Instructions on setting up the BIOS software
8) Appendix	General reference

Table Of Content

Revision History	P.1
Item Checklist	P.2
Summary of Features	P.3
6CXC/6CXC-1 Motherboard Layout	P.5
Page Index for CPU Speed Setup / Connectors / Panel and Jumper Definition	P.8
Performance List	P.28
Block Diagram	P.29
Suspend to RAM Installation	P.30
Dual BIOS Introduction	P.36
Memory Installation	P.43
Page Index for BIOS Setup	P.44
Appendix	P.77

Revision History

Revision	Revision Note	Date
3.1	Initial release of the 6CXC/6CXC-1 motherboard user's manual.	Jan.2000

The author assumes no responsibility for any errors or omissions that may appear in this document nor does the author make a commitment to update the information contained herein.

Third-party brands and names are the property of their respective owners.

Sound Blaster is a registered trademark of Creative Technology Ltd in the United States and certain other countries. Sound Blaster-LINK and SB-LINK are trademarks of Creative Technology Ltd.

Item Checklist

- The 6CXC/6CXC-1 Motherboard
- Cable for IDE / Floppy device
- CD (IUCD) for motherboard utilities
- Internal COMB Cable (Optional)
- Internal USB Cable (Optional)
- Cable for SCSI device
- 6CXC/6CXC-1 User's Manual

Summary of Features

Form factor	<ul style="list-style-type: none"> • 30.5 cm x 22 cm ATX SIZE form factor, 4 layers PCB.
CPU	<ul style="list-style-type: none"> • Pentium® II/III Processor • 256/ 512 KB 2nd cache in CPU
Chipset	<ul style="list-style-type: none"> • 82820 HOST / AGP / RDRAM Controller • 82801AA(ICH) I/O Controller Hub • 82805AA(MTH) Memory Translator Hub
Clock Generator	<ul style="list-style-type: none"> • Supports 100 / 133MHz • 105/110/115/117/120/125/127/135/137/140/145/150 MHz clocks (reserved)
Memory	<ul style="list-style-type: none"> • 4 168-pin DIMM Sockets Support 4 banks.
I/O Control	<ul style="list-style-type: none"> • Winbond W83627HF LPC
Slots	<ul style="list-style-type: none"> • 1 AMR (Audio Modem Riser) slot • 1 Universal AGP slot 1X/2X/4X 1.5V/3.3V device support • 5 32-bit Master PCI Bus slots • 1 16-bit ISA Bus slot (Optional)
On-Board IDE	<ul style="list-style-type: none"> • An IDE controller on the Intel® 82801AA PCI chipset provides IDE HDD/ CD-ROM with PIO, Bus Master and Ultra DMA33/ATA66 operation modes • Can connect up to four IDE devices
On-Board Peripherals	<ul style="list-style-type: none"> • 1 Floppy port supports 2 FDD with 360K, 720K, 1.2M, 1.44M and 2.88M bytes • 1 Parallel ports supports SPP/EPP/ECP mode • 2 Serial ports (COMA & COMB) • 4 USB ports (Front USB port optional) • 1 IrDA connector for IR/CIR
Hardware Monitor (Optional)	<ul style="list-style-type: none"> • CPU/Power Supply/System Fan Revolution detect • CPU Fan Control • System Voltage Detect • CPU Overheat Warning • Chassis Intrusion Detect • Display Actual Current Voltage
On-Board Sound (Optional)	<ul style="list-style-type: none"> • Aureal AU8810(Optional) • Line In / Line Out / Mic In / AUX In / CD In / TEL / SPDIF / Game Port
PS/2 Connector	<ul style="list-style-type: none"> • PS/2® Keyboard interface and PS/2® Mouse

Summary of Features

	interface
--	-----------

To be continued...

Summary of Feature

BIOS	<ul style="list-style-type: none">• Licensed AMI BIOS, 4M bit FWH• Support Dual BIOS(Optional)
Additional Features	<ul style="list-style-type: none">• Internal/External Modem Wake up• STR (Suspend-To-RAM)• Wake On LAN• PS/2 Keyboard Password Wake up• PS/2 Mouse Wake up• System after AC back• Poly fuse for keyboard, USB, Game port over-current protection

6CXC/6CXC-1 Motherboard Layout

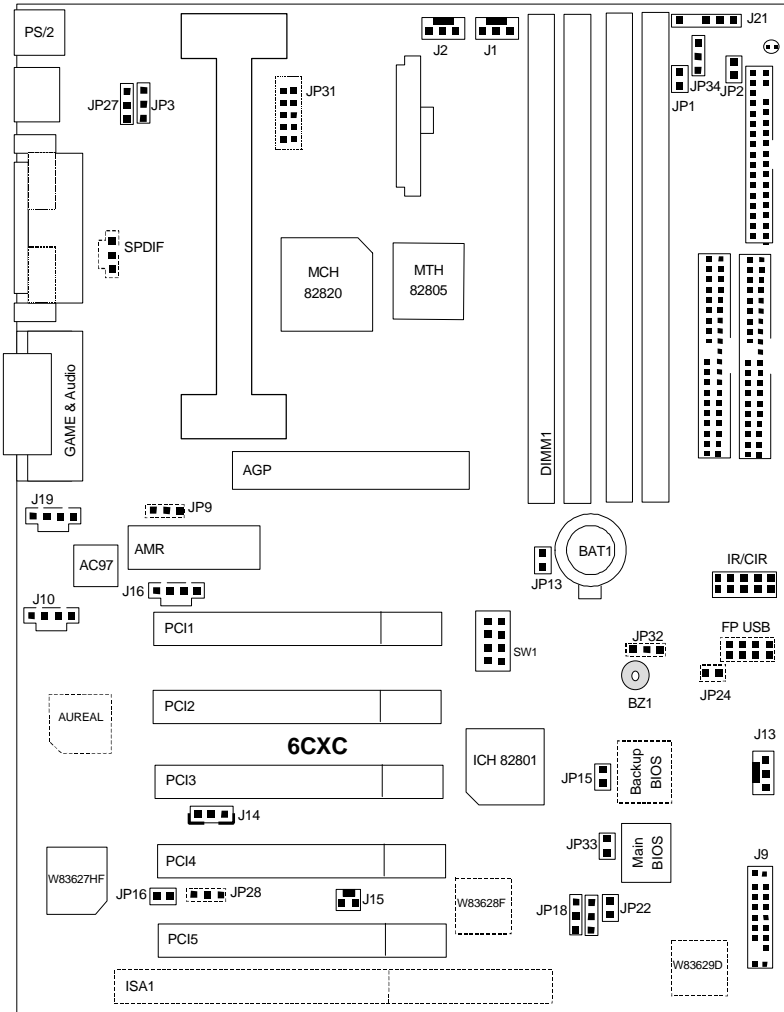

 Page Index for CPU Speed Setup/Connectors/Panel and Jumper Definition	Page
CPU Speed Setup	P.8
Connectors	P.9
GAME & Audio Port	P.9
COMA / COMB / LPT Port	P.9
USB Connector	P.10
PS/2 Keyboard & PS/2 Mouse Connector	P.10
J2 (CPU Cooling FAN Power Connector)	P.11
J1 (Power Cooling FAN Power Connector)	P.11
J13 (System Cooling FAN Power Connector)	P.12
ATX Power	P.12
Floppy Port	P.13
IDE (Primary/ Secondary) Port	P.13
IR/CIR	P.14
Front USB Port[Optional]	P.14
JP2 (STR LED Connector& DIMM LED)	P.15
J20 (SPDIF) [Optional]	P.15
J19 (AUX_IN)	P.16
J10 (CD Audio Line In)	P.16
J16 (TEL)	P.17
J14 (Wake On LAN)	P.17
J15 (Ring Power On)	P.18
J21 (External SMBUS Device Connector)	P.18
Panel and Jumper Definition	P.19
J9 (2x11 pins jumper)	P.19
JP27 (Back USB Device Wake up Selection)	P.20
JP3 (PS/2 Keyboard Power On)	P.20
JP1 (STR Selection)	P.21
JP16 (Case Open)	P.21
JP28 (Onboard Sound Function Selection) [Optional]	P.22
JP15 (Top Block Lock)	P.22
JP18 (Clear CMOS Function)	P.23
JP21 (Safe mode/Recovery/Normal)	P.23
JP22 (Timeout Reboot Function)	P.24

6CXC/6CXC-1 Motherboard

JP31 (Over Voltage CPU Speed Up) [Optional]	P.24
JP32 (Front USB Device Wake Up Selection) [Optional]	P.25

JP33 (FWH Write Protection)	P.25
JP24 (Internal Buzzer Connector) [Optional]	P.26
JP9 (AMR Select) [Optional]	P.26
JP34 (Over Clock Voltage Control)	P.27
BAT 1(Battery)	P.27

CPU Speed Setup

The system bus frequency can be switched at 100MHz and 133MHz by adjusting JP13 & SW 1. The CPU Frequency is control by BIOS.

JP13 / SW1 Select the System Speed at 100MHz and 133MHz.

AGPCLK	CPUCCLK	JP13	1	2	3	4
70	105	X				
66.6	100.3	X			X	
73.3	110	X		X		
76.6	115	X		X		X
78	117	X		X	X	
80	120	X		X	X	X
83.3	125	X	X			
84.6	127	X	X			X
66.6	133.3	X	X		X	
67.5	135	X	X		X	X
68.5	137	X	X	X		
70	140	X	X	X		X
72.5	145	X	X	X	X	
75	150	X	x	X	X	X
66.6	100/133/Auto		X		X	

(O: ON / X: OFF)

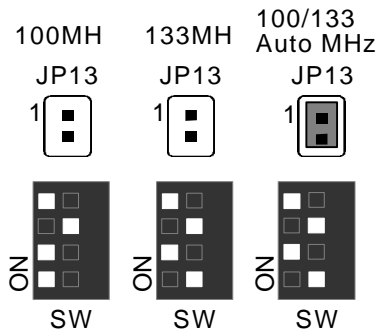
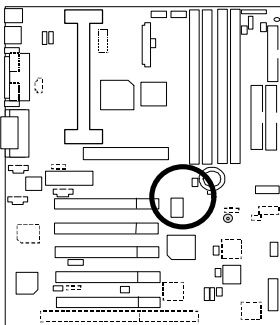

Connectors

GAME & Audio Port

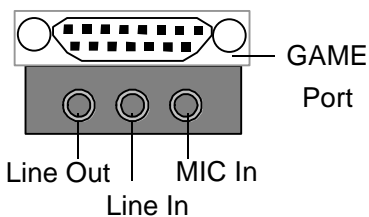
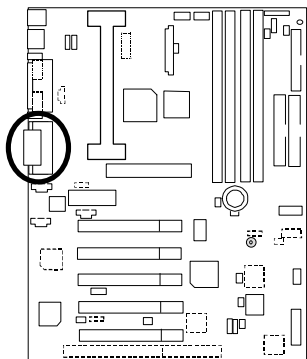

COM A / COM B / LPT Port

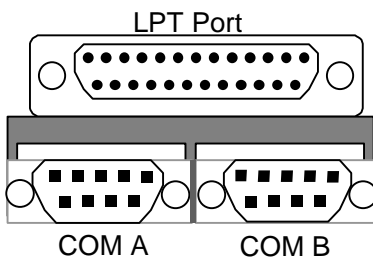
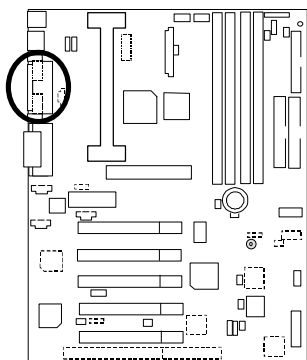

CN3 : USB Connector (Back)

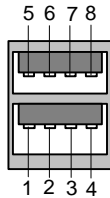
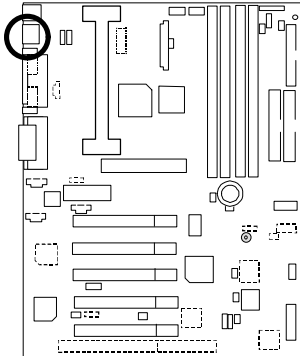

Pin No.	Definition
1	USB V0
2	USB D0-
3	USB D0+
4	GND
5	USB V1
6	USB D1-
7	USB D1+
8	GND

PS/2 Keyboard & PS/2 Mouse Connector

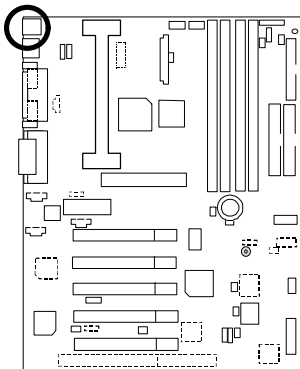

PS/2 Mouse

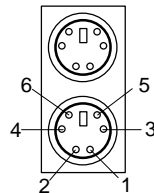

PS/2 Keyboard

PS/2 Mouse/ Keyboard	
Pin No.	Definition
1	Data
2	NC
3	GND
4	VCC(+5V)
5	Clock
6	NC

J2 : CPU Cooling FAN Power Connector

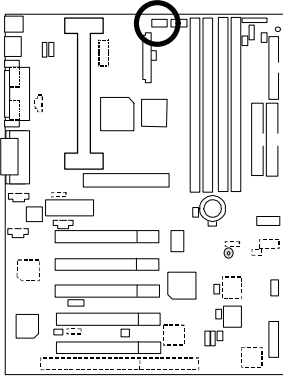

Pin No.	Definition
1	Control
2	+12V
3	SENSE

J1 : Power Cooling FAN Power Connector

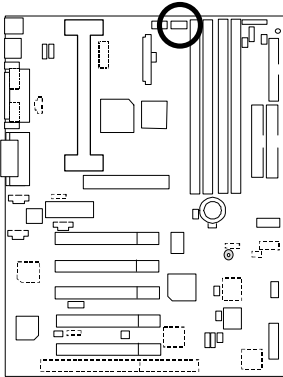

Pin No.	Definition
1	Control
2	+12V
3	SENSE

J13 : System Cooling FAN Power Connector

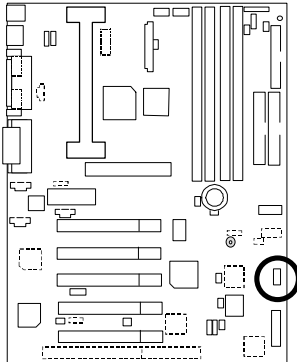

Pin No.	Definition
1	Control
2	+12V
3	SENSE

ATX Power

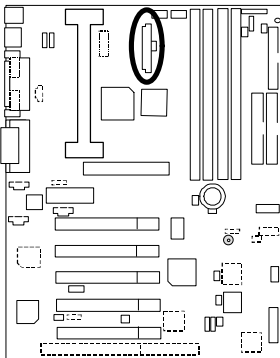

Pin No.	Definition
3,5,7,13,15-17	GND
1,2,11	3.3V
4,6,19,20	VCC
10	+12V
12	-12V
18	-5V
8	Power Good
9	5V SB stand by+5V
14	PS-ON(Soft On/Off)

Floppy Port

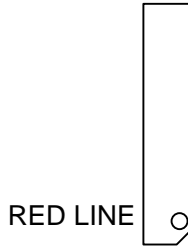
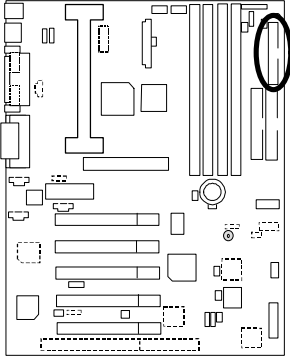

IDE1(Primary) , IDE2 (Secondary) Port

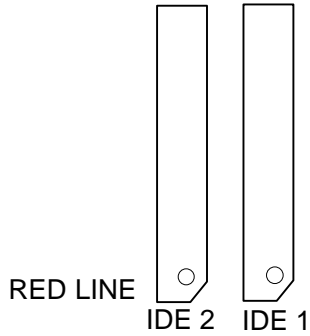
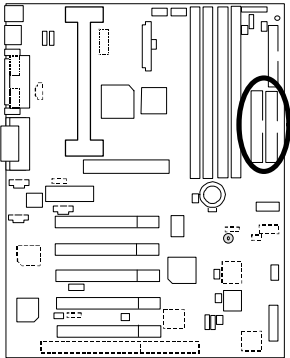

IR/CIR

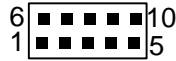
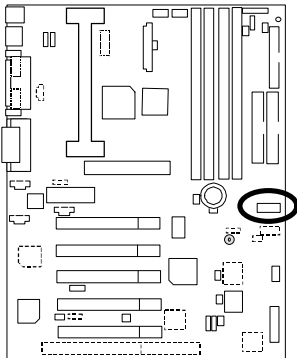

Pin No.	Definition
1	VCC
2	NC
3	IRRX
4	GND
5	IRTX
6	NC
7	CIRRX
8	VCC
9	NC
10	NC

CN9 : USB Port Connector (Front) (Optional)

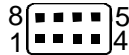
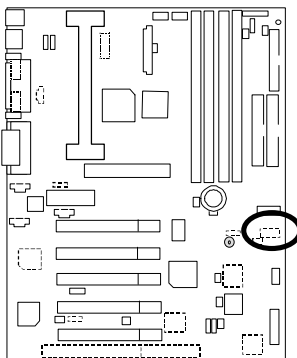

Pin No.	Definition
1	VCC
2	USB D0-
3	USB D0+
4	GND
5	VCC
6	USB D1-
7	USB D1+
8	GND

JP2 : STR LED Connector & DIMM LED

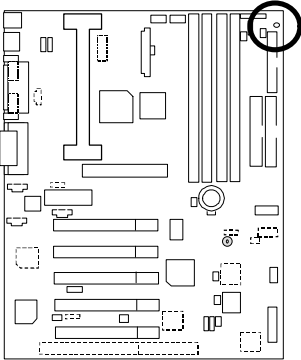

STR LED Connector External.



DIMM LED

J20 : SPDIF (The SPDIF output is capable of providing digital audio to external speakers or compressed AC3 data to an external Dolby digital decoder.) (Optional)

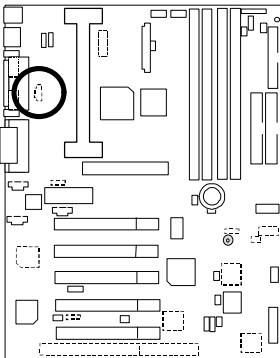

Pin No.	Definition
1	VCC
2	SPDIF OUT
3	GND

J19 : AUX IN

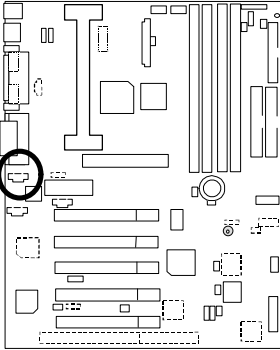

Pin No.	Definition
1	AUX-L
2	GND
3	GND
4	AUX-R

J10 : CD Audio Line In

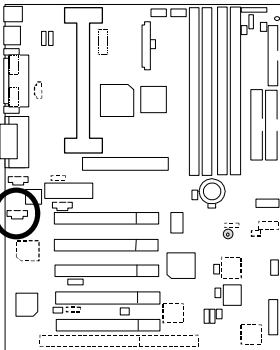

Pin No.	Definition
1	CD-L
2	GND
3	GND
4	CD-R

J16 : TEL(The connector is for internal modem card with voice connector)

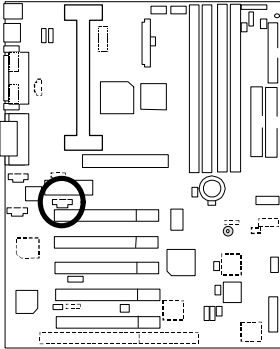

Pin No.	Definition
1	Signal-In
2	GND
3	GND
4	Signal-Out

J14: Wake on LAN

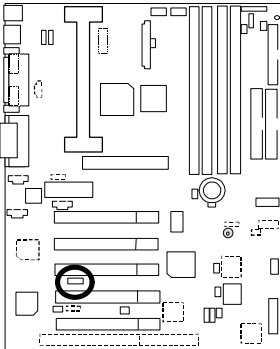

Pin No.	Definition
1	+5V SB
2	GND
3	Signal

J15: Ring Power On

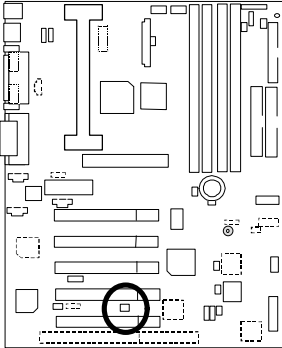

Pin No.	Definition
1	Signal
2	GND

J21 : External SMBUS Device Connector

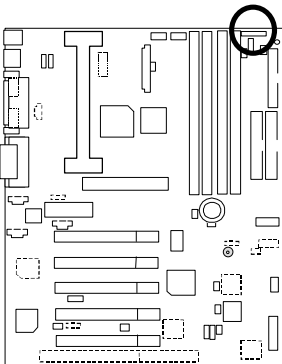

Pin No.	Definition
1	SMB CLK
2	NC
3	GND
4	SMB DATA
5	+5V

Panel and Jumper Definition

J9 : For 2X11 Pins Jumper

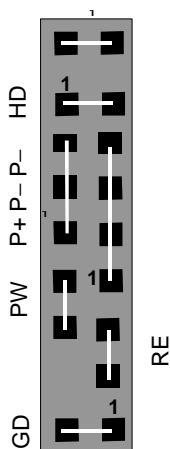
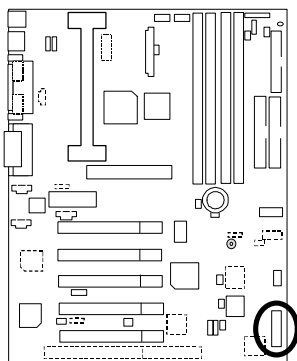

GN (Green Switch)	Open: Normal Operation Close: Entering Green Mode
GD (Green LED)	Pin 1: LED anode(+) Pin 2: LED cathode(-)
HD (IDE Hard Disk Active LED)	Pin 1: LED anode(+) Pin 2: LED cathode(-)
SPKR (Speaker Connector)	Pin 1: VCC(+) Pin 2- Pin 3: NC Pin 4: Data(-)
RE (Reset Switch)	Open: Normal Operation Close: Reset Hardware System
P+P-P-(Power LED)	Pin 1: LED anode(+) Pin 2: LED cathode(-) Pin 3: LED cathode(-)
PW (Soft Power Connector)	Open: Normal Operation Close: Power On/Off

JP27 : Back USB Device Wake up Selection
(USB Connector → CN3)

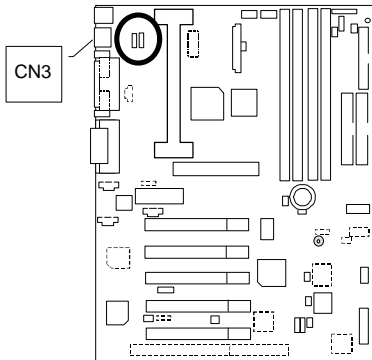

Pin No.	Definition
1-2 close	USB Device Wake up
2-3 close	Normal (Default)

(If you want to use "USB KB/Mouse Wake from S3" function, you have to set the BIOS setting "USB KB/Mouse Wake from S3" enabled, and the jumper "JP27" enabled)

*(Power on the computer and as soon as memory counting starts, press . You will enter BIOS Setup. Select the item "POWER MANAGEMENT SETUP", then select "USB KB/Mouse Wake from S3". Remember to save the setting by pressing "ESC" and choose the "SAVE & EXIT SETUP" option.)

JP3 : PS/2 Keyboard Power On

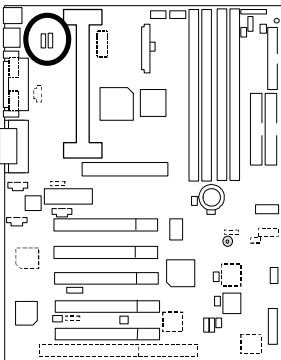

Pin No.	Definition
1-2 close	PS/2 Keyboard Power on Enabled
2-3 close	PS/2 Keyboard Power on Disabled (Default)



JP1 : STR Selection

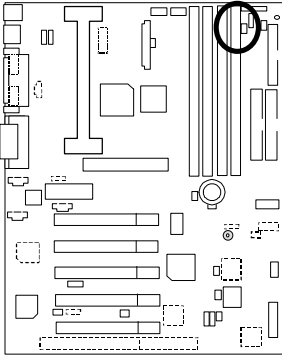

Pin No.	Definition
open	NON STR (Default)
close	STR

JP16 : Case Open

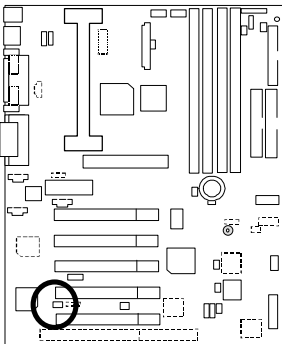

Pin No.	Definition
1	Signal
2	GND

JP28 : Onboard Sound Function Selection (Optional)

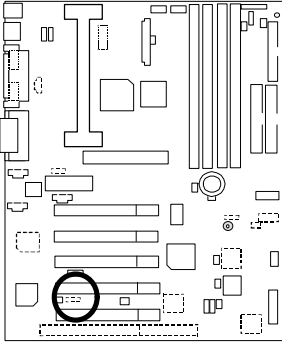

Pin No.	Definition
1-2 close	Onboard Sound Enable(Default)
2-3 close	Onboard Sound Disable

JP15 : Top Block Lock

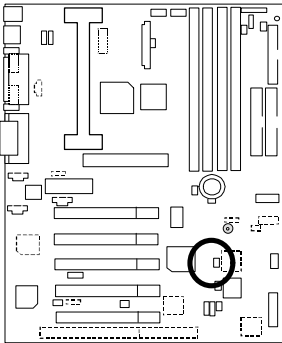

Pin No.	Definition
close	Top Block Unlock (Default)
open	Top Block lock

JP18 : Clear CMOS Function

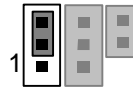
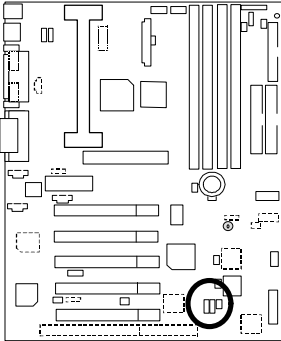

Pin No.	Definition
1-2 close	Clear CMOS
2-3 close	Normal (Default)

JP21: Safe mode / Recovery / Normal

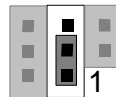
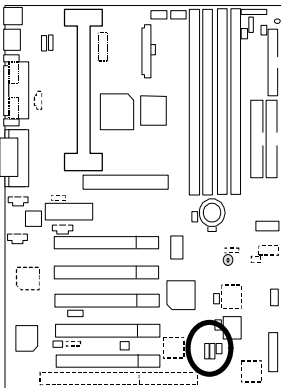

Pin No.	Definition
1-2close	Normal(Default)
2-3close	Safe mode
1-2-3open	Recovery

JP22 : Timeout Reboot Function

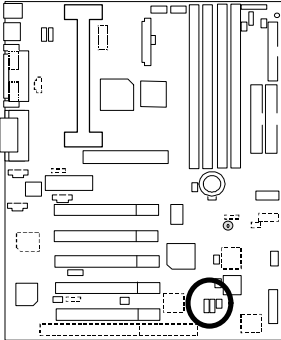

Pin No.	
open	Timeout reboot
close	No Reboot on timeout (Default)

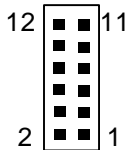
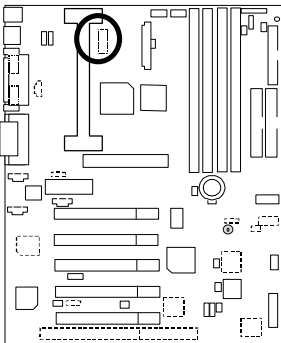

Pin No.	Definition
1-2 close	Normal (Default)
3-4 close	10%
5-6 close	20%
7-8 close	30%
9-10 close	40%
11-12 close	50%

JP32 : Front USB Device Wake up Selection (Optional)
(USB Port → CN9)

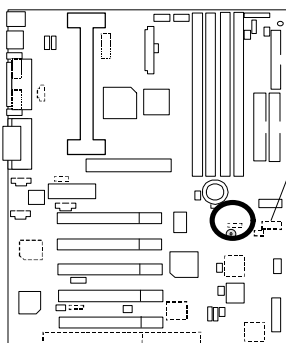

CN9



Pin No.	Definition
1-2 close	USB Device Wake Up
2-3 close	Normal (Default)

(If you want to use "USB KB/Mouse Wake from S3" function, you have to set the BIOS setting "USB KB/Mouse Wake from S3" enabled, and the jumper "JP32" enabled).
*(Power on the computer and as soon as memory counting starts, press . You will enter BIOS Setup. Select the item "POWER MANAGEMENT SETUP", then select "USB KB/Mouse Wake from S3". Remember to save the setting by pressing "ESC" and choose the "SAVE & EXIT SETUP" option.)

JP33 : FWH Write Protection

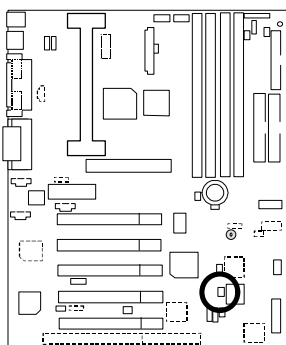

Pin No.	Definition
close	Write Protection
open	Normal (Default)

● Please Set Jumper JP33 to "Open" to enabled BIOS Write Function when you update new BIOS or new device

JP24 : Internal Buzzer Connector(Optional)

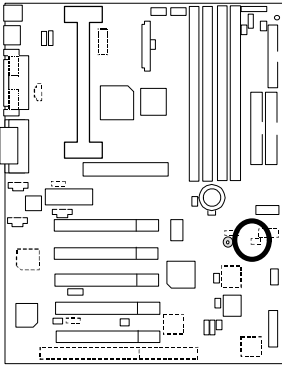

Pin No.	Definition
open	Internal Buzzer Disable
close	Internal Buzzer Enable (Default)

JP9 : AMR Select (Optional)

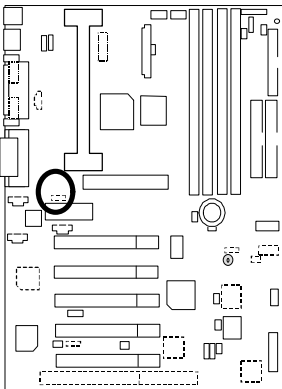

Pin No.	Definition	
	(Onboard CDOEC)	AMR Card
1-2close	Primary	Secondary
2-3close	AC'97 Disabled (Disabled Onboard CODEC)	Primary

Note:

6CX:

If M/B has hardware audio (AU8810), your modem riser has been set to "Primary" automatically.
No Jumper JP9 for 6CX

6CX-1:

JP9: 1-2 close: If you use software audio(onboard CODEC only), your modem riser must be "Secondary".
JP9: 2-3 close: If you don't use onboard software audio, your audio/modem riser must be "Primary".
Mainboard's software audio will be disabled.

JP34 : Over Clock Voltage Control

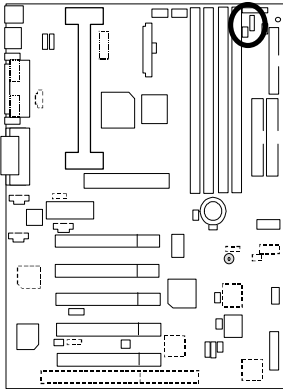

Pin No.	Definition
1-2close	Over Clock
2-3close	Normal

BAT1 : Battery

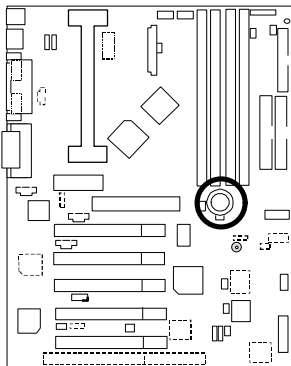

- ⚠ Danger of explosion if battery is incorrectly replaced.
- ⚠ Replace only with the same or equivalent type recommended by the manufacturer.
- ⚠ Dispose of used batteries according to the manufacturer's instructions.

Performance List

The following performance data list is the testing results of some popular benchmark testing programs.

These data are just referred by users, and there is no responsibility for different testing data values gotten by users. (The different Hardware & Software configuration will result in different benchmark testing results.)

- CPU Pentium® III 600MHz processor
- DRAM (128x2)MB SDRAM (Mosel 9928PR V54C365804VCT7)
- CACHE SIZE 512 KB included in CPU
- DISPLAY GA-660+
- STORAGE Onboard IDE (IBM DJNA-371350)
- O.S. Windows NT™ 4.0 SPK5
- DRIVER Display Driver at 1024 x 768 x 16bit colors x 75Hz.
Intel Ultra ATA Storage Driver V5.0.012(Engineering Sample)

Processor	Intel Pentium® III
	600MHz (133 x 4.5)
Winbench99	
CPU mark99	42.3
FPU Winmark 99	3010
Business Disk Winmark 99	4660
Hi-End Disk Winmark 99	10700
Business Graphics Winmark 99	243
Hi-End Graphics Winmark 99	443
Winstone99	
Business Winstone99	35.6

6CXC/6CXC-1 Motherboard

Hi-End Winstone99	32.8
-------------------	------

Block Diagram

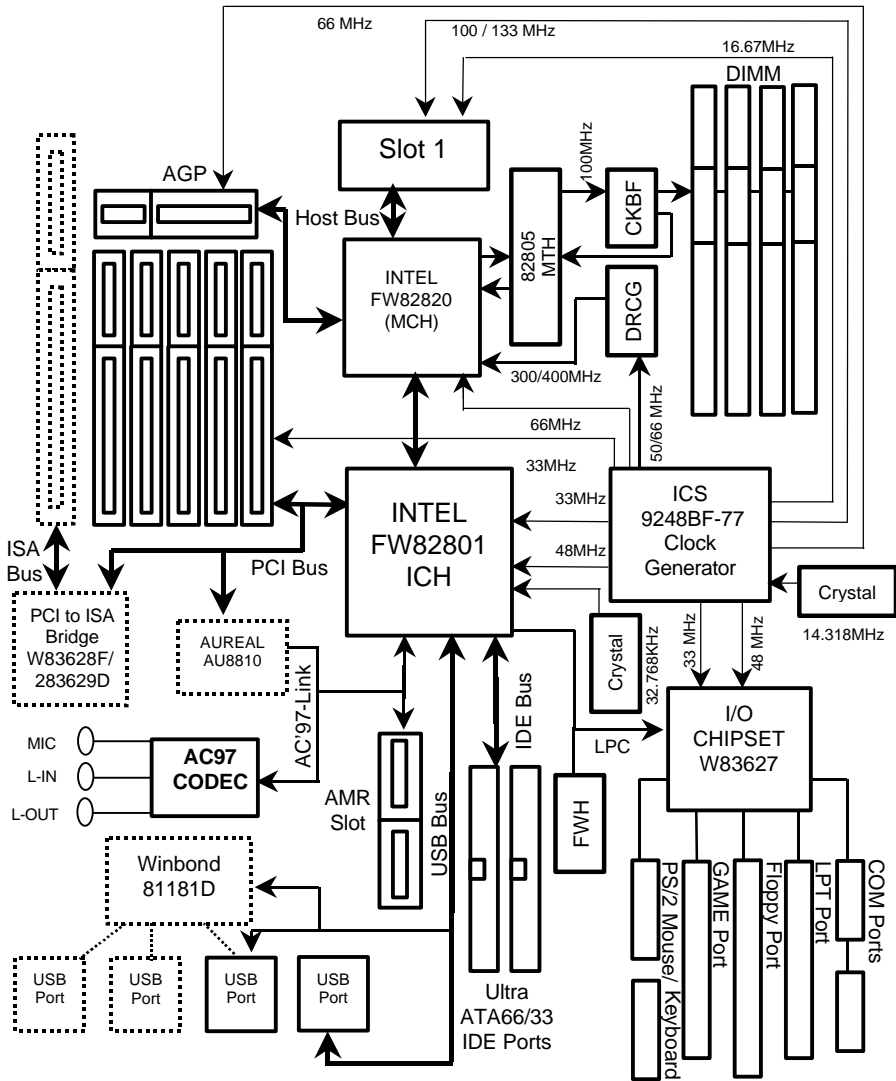

Suspend to RAM Installation

Suspend to RAM Installation

A.1 Introduce STR function:

Suspend-to-RAM (STR) is a Windows 98 ACPI sleep mode function. When recovering from STR (S3) sleep mode, the system is able, in just a few seconds, to retrieve the last "state" of the system before it went to sleep and recover to that state. The "state" is stored in memory (RAM) before the system goes to sleep. During STR sleep mode, your system uses only enough energy to maintain critical information and system functions, primarily the system state and the ability to recognize various "wake up" triggers or signals, respectively.

A.2 STR function Installation

Please use the following steps to complete the STR function installation.

Step-By-Step Setup

Step 1:

To utilize the STR function, the system must be in Windows 98 ACPI mode.

Putting Windows 98 into ACPI mode is fairly easy.

Setup with Windows 98 CD:

- A. Insert the Windows 98 CD into your CD-ROM drive, select Start, and then Run.
- B. Type (without quotes) "**D:\setup /p j**" in the window provided. Hit the enter key or click OK. In Windows 98 second edition version, all the bios version dated 12/01/99 or later are ACPI compatible. Just type "D:\Setup", the operating system will be installed as ACPI mode.
- C. After setup completes, remove the CD, and reboot your system
(This manual assumes that your CD-ROM device drive letter is D:).

Step 2:

(If you want to use STR Function, please set jumper JP1 (Closed.)

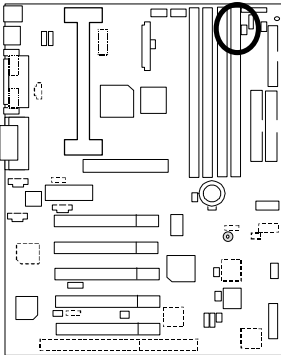

Pin No.	Definition
open	NON STR (Default)
close	STR

Step 3:

Power on the computer and as soon as memory counting starts, press . You will enter BIOS Setup. Select the item **"POWER MANAGEMENT SETUP"**, then select **"ACPI Sleep Type: S3 /STR"**. Remember to save the settings by pressing "ESC" and choose the **"SAVE & EXIT SETUP"** option.

Congratulation! You have completed the installation and now can use the STR function.

A.3 How to put your system into STR mode?

There are two ways to accomplish this:

1. Choose the "Stand by" item in the "Shut Down Windows" area.
 - A. Press the "Start" button and then select "Shut Down"



- B. Choose the "Stand by" item and press "OK"

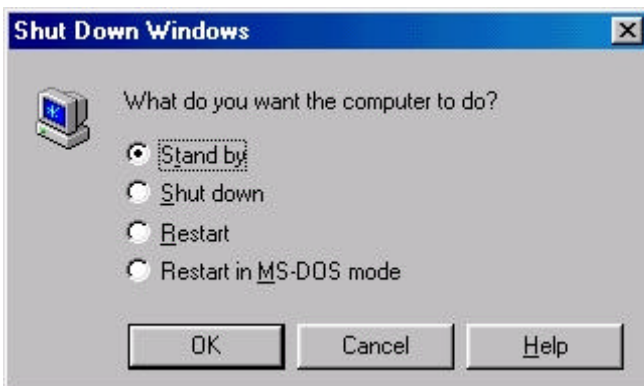

6CXC/6CXC-1 Motherboard

2. Define the system "power on" button to initiate STR sleep mode:

A. Double click "My Computer" and then "Control Panel"

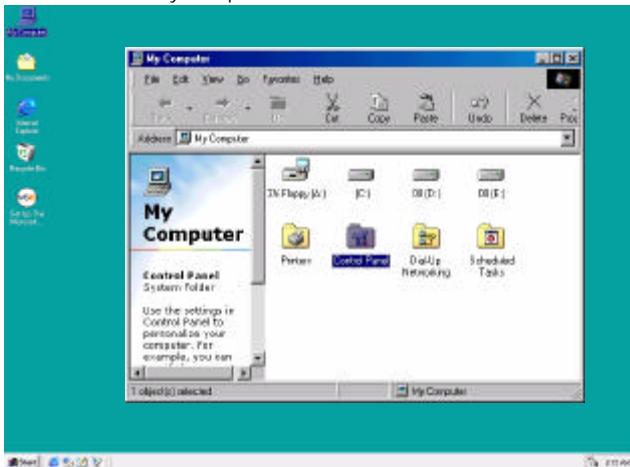

B. Double click the " Power Management" item.

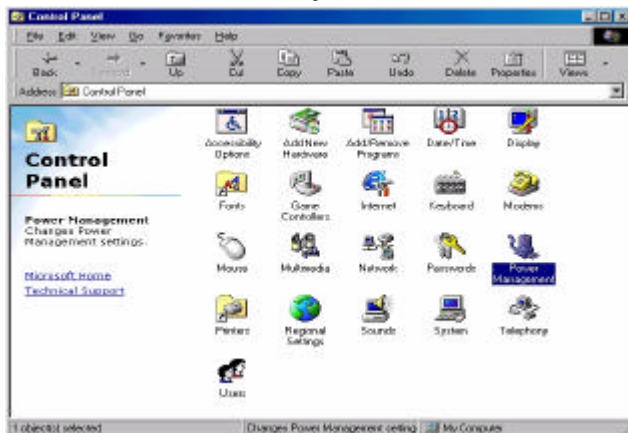

C. Select the "Advanced" tab and "Standby" mode in Power Buttons.

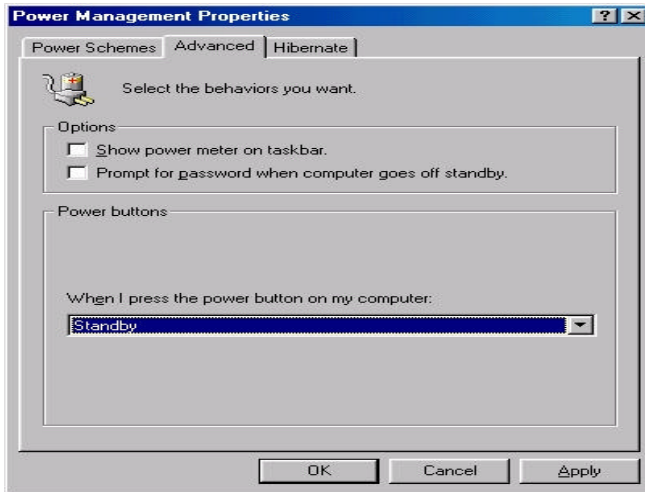

Step 4:

Restart your computer to complete setup.

Now when you want to enter STR sleep mode, just momentarily press the "Power on" button..

A.4 How to recover from the STR sleep mode?

There are seven ways to "wake up" the system:

1. Press the "Power On" button.
2. Use the "PS/2 Keyboard Power On" function.
3. Use the "PS/2 Mouse Power On" function.
4. Use the "Resume by Alarm" function.
5. Use the "Modem Ring On" function.
6. Use the "Wake On LAN" function.
7. Use the "USB Device Wake Up" function.

A.5 Notices :

1. In order for STR to function properly, several hardware and software requirements must be satisfied:
 - A. Your ATX power supply must comply with the ATX 2.01 specification (provide more than 720 mA 5V Stand-By current).
 - B. Your SDRAM must be PC-100 compliant.

2. Jumper JP2 is provided to connect to the STR LED in your system chassis. [Your chassis may not provide this feature.] The STR LED will be illuminated when your system is in STR sleep mode.

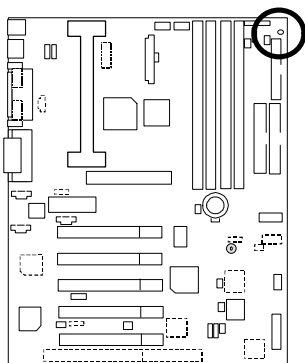

STR LED Connector External.



DIMM LED

Dual BIOS Introduction

A. What is Dual BIOS Technology?

Dual BIOS means that there are two system BIOS (ROM) on the motherboard, one is the Main BIOS and the other is Backup BIOS. Under the normal circumstances, the system works on the Main BIOS. If the Main BIOS is corrupted or damaged, the Backup BIOS can take over while the system is powered on. This means that your PC will still be able to run stably as if nothing has happened in your BIOS.

B. How to use Dual BIOS?

a. Boot Screen

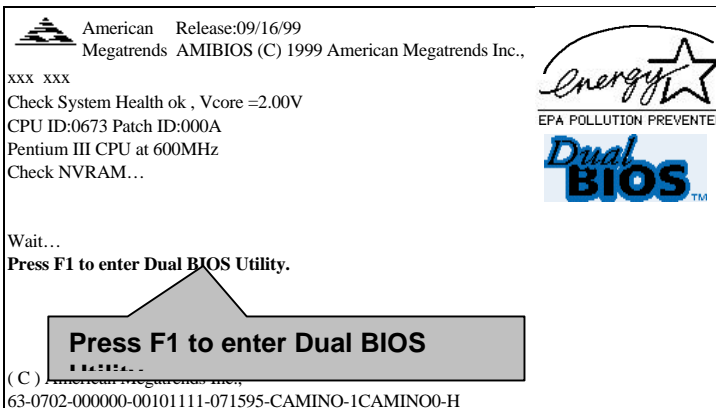

b. AMI Dual BIOS Flash ROM Programming Utility

AMI Dual BIOS Flash ROM Programming Utility	
Boot From.....	Main BIOS
Main Type.....	ROM Intel N82802AB
Backup Type.....	ROM Intel N82802AB
Wide Range Protection Disable	
Boot From Main BIOS	
Auto Recovery Enable	
Halt On Error Disable	
Copy Main ROM Data to Backup	
Load Default Settings	
Save Settings to CMOS	

c. Dual BIOS Item explanation:

BIOS will auto detect:

Boot From : Main BIOS

Main ROM Type : Intel N82802AB

Backup ROM Type : Intel N82802AB

Wide Range Protection: Disable(Default), Enable

Status 1:

If any failure (ex. Update ESCD failure, checksum error or reset...) occurs in the Main BIOS , just before the Operating System is loaded and after the power is on, and that the Wide Range Protection is set to "Enable", the PC will boot from Backup BIOS automatically.

Status 2:

If the ROM BIOS on peripherals cards(ex. SCSI Cards, LAN Cards,..) emits signals to request restart of the system after the user make any alteration on it, the boot up BIOS will not be changed to the Backup BIOS.

Boot From : Main BIOS (Default), Backup BIOS

Status 1:

The user can set to boot from main BIOS or Backup BIOS.

Auto Recovery : Enabled(Default), Disabled

When one of the Main BIOS or Backup BIOS occurs checksum failure, the working BIOS will automatically recover the BIOS of checksum failure.

(In the Power Management Setup of the BIOS Setting, if ACPI Suspend Type is set to Suspend to RAM, the Auto Recovery will be set to Enable automatically.)

(If you want to enter the BIOS setting, please press “Del” key when the boot screen appears.)

Halt On Error : Disable(Default), Enable

If the BIOS occurs a checksum error or the Main BIOS occurs a WIDE RANGE PROTECTION error and Halt On BIOS Defects set to Enable, the PC will show messages on the boot screen, and the system will pause and wait for the user's instruction.

If Auto Recovery :**Disable**, it will show *<or the other key to continue.>*

If Auto Recovery :**Enable**, it will show *<or the other key to Auto Recover.>*

Copy Main ROM Data to Backup

Backup message:

Are you sure to copy BIOS?

[Enter] to continue or [Esc] to abort ...

The means that the Main BIOS works normally and could automatically recover the Backup BIOS. Or the means that the Backup BIOS works normally and could automatically recover the Main BIOS.

(This auto recovery utility is set by system automatically and can't be changed by user.)



DualBIOS™ Technology FAQ

GIGABYTE Technology is pleased to introduce DualBIOS technology, a hot spare for your system BIOS. This newest "Value-added" feature, in a long series of innovations from GIGABYTE, is available on GA-6CXC/6CXC-1 motherboard. Future GIGABYTE motherboards will also incorporate this innovation.

What's DualBIOS™?

On GIGABYTE motherboards with DualBIOS there are physically two BIOS chips. For simplicity we'll call one your "Main BIOS" and the other is your "Backup" BIOS (your "hot spare"). If your Main BIOS fails, the Backup BIOS almost automatically takes over on your next system boot. Almost automatically and with virtually zero down time! Whether the problem is a failure in flashing your BIOS or a virus or a catastrophic failure of the Main BIOS chip, the result is the same - the Backup BIOS backs you up, almost automatically.

I. Q: What is DualBIOS™ technology?

Answer:

DualBIOS technology is a patented technology from Giga-Byte Technology. The concept of this technology is based on the redundancy and fault tolerance theory. DualBIOS™ technology simply means there are two system BIOSes (ROM) integrated onto the motherboard. One is a main BIOS, and the other is a backup BIOS. The mainboard will operate normally with the main BIOS, however, if the main BIOS is corrupt or damaged for various reasons, the backup BIOS will be automatically used when the system powered-On. Your PC will operate as before the main BIOS was damaged, and is completely transparent to the user.

II. Q: Why does anyone need a motherboard with DualBIOS™ technology?

Answer:

In today's systems there are more and more BIOS failures. The most common reasons are virus attacks, BIOS upgrade failures, and/or deterioration of the BIOS (ROM) chip itself.

1. New computer viruses are being found that attack and destroy the system BIOS. They may corrupt your BIOS code, causing your PC to be unstable or even not boot normally.
2. BIOS data will be corrupted if a power loss/surge occurs, or if a user resets the system, or if the power button is pressed during the process of performing a system BIOS upgrade.
3. If a user mistakenly updates their mainboard with the incorrect BIOS file, then the system may not be able to boot correctly. This may cause the PC system hang in operation or during boot.
4. A flash ROM's life cycle is limited according to electronic characteristics. The modern PC utilizes the Plug and Play BIOS, and is updated regularly. If a user changes peripherals often, there is a slight chance of damage to the flash ROM.

With Giga-Byte Technology's patented DualBIOS™ technology you can reduce the possibility of hangs during system boot up, and/or loss BIOS data due to above reasons. This new technology will eliminate valuable system down time and costly repair bills cause by BIOS failures.

III. Q: How does DualBIOS™ technology work?

Answer:

1. DualBIOS™ technology provides a wide range of protection during the boot up procedure. It protects your BIOS during system POST, ESCD update, and even all the way to PNP detection/assignment.
2. DualBIOS™ provides automatic recovery for the BIOS. When the first BIOS used during boot up does not complete or if a BIOS checksum error occurs, boot-up is still possible. In the DualBIOS™ utility, the "Auto Recovery" option will guarantee that if either the main BIOS or backup BIOS is corrupted, the DualBIOS™ technology will use the good BIOS and correct the wrong BIOS automatically.
3. DualBIOS™ provides manual recovery for the BIOS. DualBIOS™ technology contains a built-in flash utility, which can flash your system BIOS from backup to main and/or visa versa. There is no need for an OS-dependent flash utility program.
4. DualBIOS™ contains a one-way flash utility. The built-in one-way flash utility will ensure that the corrupt BIOS is not mistaken as the good BIOS during recovery and that the correct BIOS (main vs. backup) will be flashed. This will prevent the good BIOS from being flashed.

IV. Q: Who Needs DualBIOS™ technology?

Answer:

1. Every user should have DualBIOS™ technology due to the advancement of computer viruses.

Everyday, there are new BIOS-type viruses discovered that will destroy your system BIOS. Most commercial products on the market do not have solutions to guard against this type of virus intrusion. The DualBIOS™ technology will provide a state-of-the-art solution to protect your PC:

Case I.) Vicious computer viruses may wipe out your entire system BIOS. With a conventional single system BIOS PC, the PC will not be functional until it is sent for repairs.

Case II.) If the "Auto Recovery" option is enabled in the DualBIOS™ utility, and if a virus corrupts your system BIOS, the backup BIOS will automatically reboot the system and correct the main BIOS.

Case III.) A user may override booting from the main system BIOS. The DualBIOS™ utility may be entered to manually change the boot sequence to boot from the backup BIOS.

2. During or after a BIOS upgrade, if DualBIOS™ detects that the main BIOS is corrupt, the backup BIOS will take over the boot-up process automatically. Moreover, it will verify the main and backup BIOS checksums when booting-up. DualBIOS™ technology examines the checksum of the main and backup BIOS while the system is powered on to guarantee your BIOS operates properly.
3. Power Users will have the advantage of having two BIOS versions on their mainboard. The benefit is being able to select either version BIOS to suit the performance system needs.
4. Flexibility for high-end desktop PCs and workstation/servers. In the DualBIOS™ utility, the option can be set, "Halt On When BIOS Defects," to be enabled to halt your system with a warning message that the main BIOS has been corrupted. Most workstation/servers require constant operation to guarantee services have not been interrupted. In this situation, the "Halt On When BIOS Defects" message may be disabled to avoid system pauses during normal booting. Another advantage you gain from Giga-Byte's DualBIOS™ technology is the ability to upgrade from dual 2 Mbit BIOS to dual 4 Mbit BIOS in the future if extra BIOS storage is need.

Memory Installation

The motherboard has 4 dual inline memory module (DIMM) sockets. The BIOS will automatically detects memory type and size. To install the memory module, just push it vertically into the DIMM Slot .The DIMM module can only fit in one direction due to the two notch. Memory size can vary between sockets.

Install memory in any combination table:

Location	168-pin SDRAM DIMM Modules	Note
DIMM1	Single – Sided	
	Double – Sided	DIMM4 must be empty
DIMM2	Single – Sided	
	Double – Sided	DIMM3 must be empty
DIMM3	Single – Sided	
	Double – Sided	DIMM2 must be empty
DIMM4	Single – Sided	
	Double – Sided	DIMM1 must be empty
Total System Memory (Max 1GB)		

Supports 16 / 32 / 64 / 128 / 256 / 512 MB SDRAM DIMM Modules .At the time this User's Manual was written, 512MB DIMM's are only available as Double-sided registered memory (128MB cells).

 Page index for BIOS Setup	Page
The Main Menu	P.46
Standard CMOS Setup	P.49
BIOS Features Setup	P.52
Chipset Features Setup	P.55
Power Management Setup	P.58
PNP/ PCI Configuration	P.63
Load BIOS Defaults	P.65
Load Setup Defaults	P.66
Integrated Peripherals	P.67
Hardware Monitor Setup	P.71
Supervisor / User Password	P.73
IDE HDD Auto Detection	P.74
Save & Exit Setup	P.75
Exit Without Saving	P.76

BIOS Setup

BIOS Setup is an overview of the BIOS Setup Program. The program that allows users to modify the basic system configuration. This type of information is stored in battery-backed CMOS RAM so that it retains the Setup information when the power is turned off.

ENTERING SETUP

Power On the computer and press immediately will allow you to enter Setup. If the message disappears before you respond and you still wish to enter Setup, restart the system to try again by turning it OFF then ON or pressing the "RESET" bottom on the system case. You may also restart by simultaneously press <Ctrl> – <Alt>– keys.

CONTROL KEYS

<↑>	Move to previous item
<↓>	Move to next item
<<←>	Move to the item in the left hand
<→>	Move to the item in the right hand
<Esc>	Main Menu - Quit and not save changes into CMOS Status Page Setup Menu and Option Page Setup Menu - Exit current page and return to Main Menu
<+/ PgUp>	Increase the numeric value or make changes
<-/ PgDn>	Decrease the numeric value or make changes
<F1>	General help, only for Status Page Setup Menu and Option Page Setup Menu
<F2>	Reserved
<F3>	Reserved
<F4>	Reserved
<F5>	Restore the previous CMOS value from CMOS, only for Option Page Setup Menu
<F6>	Load the default CMOS value from BIOS default table, only for Option Page Setup Menu
<F7>	Load the Setup Defaults.
<F8>	Reserved
<F9>	Reserved
<F10>	Save all the CMOS changes, only for Main Menu

GETTING HELP

Main Menu

The on-line description of the highlighted setup function is displayed at the bottom of the screen.

Status Page Setup Menu / Option Page Setup Menu

Press F1 to pop up a small help window that describes the appropriate keys to use and the possible selections for the highlighted item. To exit the Help Window press <Esc>.

The Main Menu

Once you enter AMI BIOS CMOS Setup Utility, the Main Menu (Figure 1) will appear on the screen. The Main Menu allows you to select from nine setup functions and two exit choices. Use arrow keys to select among the items and press <Enter> to accept or enter the sub-menu.

AMIBIOS SIMPLE SETUP UTILITY – VERSION 1.20 (C) 1998 American Megatrends, Inc. All Rights Reserved	
STANDARD CMOS SETUP	INTEGRATED PERIPHERALS
BIOS FEATURES SETUP	HARDWARE MONITOR SETUP
CHIPSET FEATURES SETUP	SUPERVISOR PASSWORD
POWER MANAGEMENT SETUP	USER PASSWORD
PNP / PCI CONFIGURATION	IDE HDD AUTO DETECTION
LOAD BIOS DEFAULTS	SAVE & EXIT SETUP
LOAD SETUP DEFAULTS	EXIT WITHOUT SAVING
ESC: Quit ↑↓→← : Select Item (Shift)F2 : Change Color F5: Old Values F6: Load BIOS Defaults F7: Load Setup Defaults F10: Save & Exit	
Time, Date , Hard Disk Type...	

Figure 1: Main Menu

- **Standard CMOS Setup**

This setup page includes all the items in standard compatible BIOS.

- **BIOS Features Setup**

This setup page includes all the items of AMI special enhanced features.

- **Chipset Features Setup**

This setup page includes all the items of chipset special features.

- **Power Management Setup**

This setup page includes all the items of Green function features.

- **PnP/PCI Configuration**

This setup page includes all the configurations of PCI & PnP ISA resources.

- **Load BIOS Defaults**

BIOS Defaults indicates the value of the system parameters which the system would be in safe configuration.

- **Load Setup Defaults**

Setup Defaults indicates the value of the system parameters which the system would be in best performance configuration.

- **Integrated Peripherals**

This setup page includes all onboard peripherals.

- **Hardware Monitor Setup**

This setup page is the System auto detect Temperature, voltage, fan, speed.

- **Supervisor password**

Change, set, or disable password. It allows you to limit access to the system and Setup, or just to Setup.

- **User password**

Change, set, or disable password. It allows you to limit access to the system.

- **IDE HDD auto detection**

Automatically configure hard disk parameters.

- **Save & Exit Setup**

Save CMOS value settings to CMOS and exit setup.

- **Exit Without Saving**

Abandon all CMOS value changes and exit setup.

Standard CMOS Setup

The items in Standard CMOS Setup Menu (Figure 2) are divided into 10 categories. Each category includes no, one or more than one setup items. Use the arrows to highlight the item and then use the <PgUp> or <PgDn> keys to select the value you want in each item.

AMIBIOS SETUP – STANDARD CMOS SETUP	
(C) 1998 American Megatrends, Inc. All Rights Reserved	
Date (mm/dd/yyyy) : Mon, Nov 15, 1999	
Time (hh/mm/ss) : 14:44:35	
<u>TYPE SIZE CYLS HEAD PRECOMP LANDZ SECTOR MODE</u>	
Pri Master Auto	
Pri Slave Auto	
Sec Master Auto	
Sec Slave Auto	
Floppy Drive A : 1.44 MB 3½	Base Memory : 640 Kb
Floppy Drive B : Not Installed	Other Memory : 384 Kb
	Extended Memory : 63 Mb
Boot Sector Virus Protection : Disabled	Total Memory : 64 Mb
Month : Jan – Dec	ESC : Exit
Day : 01– 31	↑↓ : Select Item
Year : 1980 – 2099	PU / PD / + / - : Modify
	(Shift) F2 : Color

Figure 2: Standard CMOS Setup

- **Date**

The date format is <week>, <month> <day> <year>.

week	The week, from Sun to Sat, determined by the BIOS and is display-only
month	The month, Jan. Through Dec.
day	The day, from 1 to 31 (or the maximum allowed in the month)
year	The year, from 1980 through 2099

- **Time**

The times format in <hour> <minute> <second>. The time is calculated base on the 24-hour military-time clock. For example, 1 p.m. is 13:00:00.

- **Primary Master, Slave / Secondary Master, Slave**

The category identifies the types of hard disk from drive C to F that has been installed in the computer. There are two types: auto type, and user definable type. User type is user-definable; Auto type which will automatically detect HDD type.

Note that the specifications of your drive must match with the drive table. The hard disk will not work properly if you enter improper information for this category.

If you select User Type, related information will be asked to enter to the following items. Enter the information directly from the keyboard and press <Enter>. Such information should be provided in the documentation from your hard disk vendor or the system manufacturer.

CYLS.	Number of cylinders
HEADS	number of heads
PRECOMP	write precomp
LANDZONE	Landing zone
SECTORS	number of sectors

If a hard disk has not been installed select NONE and press <Enter>.

- **Floppy Drive A type / Drive B**

The category identifies the types of floppy disk drive A or drive B that has been installed in the computer.

None	No floppy drive installed
360K, 5.25 in.	5.25 inch PC-type standard drive; 360K byte capacity.
1.2M, 5.25 in.	5.25 inch AT-type high-density drive; 1.2M byte capacity (3.5 inch when 3 Mode is Enabled).
720K, 3.5 in.	3.5 inch double-sided drive; 720K byte capacity
1.44M, 3.5 in.	3.5 inch double-sided drive; 1.44M byte capacity.
2.88M, 3.5 in.	3.5 inch double-sided drive; 2.88M byte capacity.

- **Boot Sector Virus Protection**

If it is set to enable, the category will flash on the screen when there is any attempt to write to the boot sector or partition table of the hard disk drive. The system will halt and the following error message will appear in the mean time. You can run anti-virus program to locate the problem.

Enabled	Activate automatically when the system boots up causing a warning message to appear when anything attempts to access the boot sector or hard disk partition table
Disabled	No warning message to appear when anything attempts to access the boot sector or hard disk partition table (Default Value)

- **Memory**

The category is display-only which is determined by POST (Power On Self Test) of the BIOS.

Base Memory

The POST of the BIOS will determine the amount of base (or conventional) memory installed in the system.

The value of the base memory is typically 512 K for systems with 512 K memory installed on the motherboard, or 640 K for systems with 640 K or more memory installed on the motherboard.

Other Memory

This refers to the memory located in the 640 K to 1024 K address space. This is memory that can be used for different applications.

DOS uses this area to load device drivers to keep as much base memory free for application programs. Most use for this area is Shadow RAM.

Extended Memory

The BIOS determines how much extended memory is present during the POST.

This is the amount of memory located above 1 MB in the CPU's memory address map.

BIOS Features Setup

AMIBIOS SETUP – BIOS FEATURES SETUP			
(C) 1998 American Megatrends, Inc. All Rights Reserved			
Quick Boot	Enabled	CC00, 16K Shadow	Disabled
1 st Boot Device	Floppy	D000, 16K Shadow	Disabled
2 nd Boot Device	IDE-0	D400, 16K Shadow	Disabled
3 rd Boot Device	CDROM	D800, 16K Shadow	Disabled
Try Other Boot Devices	Yes	DC00, 16K Shadow	
Floppy Access Control	Read-Write		
Hard Disk Access Control	Read-Write		
S.M.A.R.T. for Hard Disks	Disabled		
BootUp Num-Lock	On		
Floppy Drive Swap	Disabled		
Floppy Drive Seek	Disabled		
Password Check	Setup		
Boot To OS/2 > 64MB	No		
CPU Serial Number	Enabled		
L2 Cache	WriteBack		
Cache Bus ECC	Enabled	ESC: Quit	↑↓→←: Select Item
System BIOS Cacheable	Enabled	F1 : Help	PU/PD+/-/: Modify
BIOS Write Protect	Disabled	F5 :Old Values(Shift)F2:Color	
C000, 32K Shadow	Cached	F6 : Load BIOS Defaults	
C800, 16K Shadow	Disabled	F7 : Load Setup Defaults	

Figure 3: BIOS Features Setup

- **Quick Boot**

Enabled	Enabled Quick Boot Function. (Default Value)
Disabled	Disabled Quick Boot Function.

- **1st / 2nd / 3rd Boot Device**

Floppy	Boot Device by Floppy.
LS/ZIP A:	Boot Device by LS/ZIP A:.
CDROM	Boot Device by CDROM.
SCSI	Boot Device by SCSI.
NETWORK	Boot Device by NETWORK.
IDE-0-IDE-3	Boot Device by IDE-0-IDE-3.
Disabled	Boot Device by Disabled.
ATAPI ZIP C:	Boot Device by ATAPI ZIP C:.

- **Try Other Boot Device**

Yes	Enabled other device to boot system. (Default Value)
No	Disabled other device to boot system.

- **Floppy Access Control**

Read-Write	Set Floppy Access Control : Read-Write. (Default Value)
Read-Only	Set Floppy Access Control : Read Only.

- **Hard Disk Access Control**

Read-Write	Set Hard Disk Access Control : Read-Write. (Default Value)
Read-Only	Set Hard Disk Access Control : Read Only.

- **S.M.A.R.T. for Hard Disks**

Enable	Enable S.M.A.R.T. Hard for Disks.
Disable	Disable S.M.A.R.T. Hard for Disks. (Default Value)

- **Boot Up Num-Lock**

On	Keypad is number keys. (Default Value) .
Off	Keypad is arrow keys.

- **Floppy Drive Swap**

Enabled	Floppy A & B will be swapped under DOS
Disabled	Floppy A & B will be normal definition (Default Value) .

- **Floppy Drive Seek**

During POST, BIOS will determine if the floppy disk drive installed is 40 or 80 tracks. 360 type is 40 tracks while 720 , 1.2 and 1.44 are all 80 tracks.

Enabled	BIOS searches for floppy disk drive to determine if it is 40 or 80 tracks. Note that BIOS can not tell from 720, 1.2 or 1.44 drive type as they are all 80 tracks.
Disabled	BIOS will not search for the type of floppy disk drive by track number. Note that there will not be any warning message if the drive installed is 360. (Default Value)

- **Password Check**

Setup	Set Password Check to Setup. (Default Value)
Always	Set Password Check to Always.

- **Boot To OS/2 > 64MB**

Yes	Enabled Boot To OS/2.
No	Disabled Boot To OS/2. (Default Value)

- **CPU Serial Number**

Disabled	Disabled CPU Serial Number. (Default Value)
Enabled	Enabled CPU Serial Number. (Default Value)

- **L2 Cache**

WriteBack	Set L2 Cache is WriteBack. (Default Value)
Disabled	Disabled this Function.
WriteThru	Set L2 Cache is WriteThru.

- **Cache Bus ECC**

Enabled	Enable Cache Bus ECC. (Default Value)
Disabled	Disable Cache Bus ECC.

- **System BIOS Cacheable**

Enabled	Enabled System BIOS Cacheable. (Default Value)
Disabled	Disabled System BIOS Cacheable.

- **BIOS Write Protect**

Enabled	Enabled BIOS Write Protect.
Disabled	Disabled BIOS Write Protect. (Default Value)

- **C000 32K Shadow- DC00 16K Shadow**

These categories determine whether optional ROM will be copied to RAM by 16 byte.

Enabled	Optional shadow is enabled.
Disabled	Optional shadow is disabled.
Cached	Optional shadow is cached.

Chipset Features Setup

AMIBIOS SETUP – CHIPSET FEATURES SETUP (C) 1998 American Megatrends, Inc. All Rights Reserved	
SDRAM CAS Latency	Auto
Memory Buffer Strength	Auto
CPU BIST Enable	Disabled
Memory Hole	Disabled
ICH Delayed Transaction	Enabled
ICH DCB Enable	Disabled
VGA Frame Buffer USWC	Disabled
PCI Frame Buffer USWC	Disabled
Graphics Aperture Size	64 MB
ClkGen Spread Spectrum	Enabled
ClkGen for PCI Slot	Disabled
CPU/PCI Frequency	100.3/33.4
CPU Ratio Selection	3.0x
USB Function	Enabled
USB Legacy Support	Disabled
ESC: Quit ↑↓→←: Select Item F1 : Help PU/PD+/-: Modify F5 :Old Values(Shift)F2:Color F6 : Load BIOS Defaults F7 : Load Setup Defaults	

Figure 4: Chipset Features Setup

- SDRAM CAS Latency**

Auto	Set SDRAM CAS Latency is Auto. (Default Value)
3 SCLKS	Set SDRAM CAS Latency is 3SCLKS.
2 SCLKS	Set SDRAM CAS Latency is 2SCLKS.

- Memory Buffer Strength**

Auto	Set Memory Buffer Strength is Auto. (Default Value)
X1	Set Memory Buffer Strength is X1.
X2	Set Memory Buffer Strength is X2.

- CPU BIST Enable**

Disabled	Disable CPU BIST. (Default Value)
Enabled	Enable CPU BIST.

- Memory Hole**

Disabled	Normal Setting. (Default Value)
15MB-16MB	Set Address=15-16MB relocate to ISA BUS.

- **ICH Delayed Transaction**

Disabled	Disabled ICH Delayed Transaction.
Enabled	Enabled ICH Delayed Transaction. (Default Value)

- **ICH DCB Enable**

Disabled	Disable ICH DCB. (Default Value)
Enabled	Enable ICH DCB.

- **VGA Frame Buffer USWC**

Disabled	Disable VGA Frame Buffer USWC. (Default Value)
Enabled	Enable VGA Frame Buffer USWC.

- **PCI Frame Buffer USWC**

Disabled	Disable PCI Frame Buffer USWC. (Default Value)
Enabled	Enable PCI Frame Buffer USWC.

- **Graphics Aperture Size**

64 MB	Display Graphics Aperture Size is 64MB. (Default Value)
32 MB	Display Graphics Aperture Size is 32MB.
16 MB	Display Graphics Aperture Size is 16MB.
4 MB	Display Graphics Aperture Size is 4MB.
8 MB	Display Graphics Aperture Size is 8MB.
128 MB	Display Graphics Aperture Size is 128MB.
256 MB	Display Graphics Aperture Size is 256MB.

- **ClkGen Spread Spectrum**

Disabled	Disabled ClkGen Spread Spectrum.
Enabled	Enabled ClkGen Spread Spectrum. (Default Value)

- **ClkGen for PCI Slot**

Disabled	ClkGen for PCI Slot Disabled. (Default Value)
Enabled	ClkGen for PCI Slot Enabled.

- **CPU / PCI Frequency**

System auto detect CPU and PCI frequency.

- **CPU Ratio Selection**

2.0x(Safe)/2.5x/3.0x/3.5x/4.0x/4.5x/5.0x/5.5x/6.0x/6.5x/7.0x/7.5x/8.0x
--

- **USB Function**

Disabled	Disable USB Function.
Enabled	Enable USB Function. (Default Value)

- **USB Legacy Support**

USB Legacy Support can be set when USB Function is Enable.

Disabled	Disable USB Legacy Support. (Default Value)
Keyb+ Mouse	USB Keyboard and Mouse Support.
Keyboard	USB Keyboard Support.



Power Management Setup

AMIBIOS SETUP – POWER MANAGEMENT SETUP (C) 1998 American Megatrends, Inc. All Rights Reserved			
ACPI Sleep Type	S1/POS	System Thermal	Ignore
USB KB/MS Wakeup From S3	Disabled	Soft-off by Power Button	Instant Off
Power Management/APM	Enabled	AC Back Function	Last State
Video Power Down Mode	Suspend	Modem Use IRQ	4
Hard Disk Power Down Mode	Suspend	Modem Ring On/Wake On Lan	Enabled
Standby Time Out (Minute)	Disabled	PME Event Wake Up	Disabled
Suspend Time Out (Minute)	Disabled	RTC Alarm PowerOn	Disabled
K/B & PS/2 Mouse Access	Monitor	RTC Alarm Date	15
FDC/LPT/COM Ports Access	Monitor	RTC Alarm Hour	12
SB/MSS Audio Ports Access	Ignore	RTC Alarm Minute	30
MID Ports Access	Ignore	RTC Alarm Second	30
ADLIB Ports Access	Ignore		
Pri. Master IDE Access	Monitor		
Pri. Slave IDE Access	Ignore		
Sec. Master IDE Access	Monitor		
Sec. Slave IDE Access	Ignore	ESC: Quit	↑↓→←: Select Item
PIRQ[A] IRQ Active	Ignore	F1 : Help	PU/PD+/-/: Modify
PIRQ[B] IRQ Active	Ignore	F5 :Old Values(Shift)F2:Color	
PIRQ[C] IRQ Active	Ignore	F6 : Load BIOS Defaults	
PIRQ[D] IRQ Active	Ignore	F7 : Load Setup Defaults	

Figure 5: Power Management Setup

- **ACPI Sleep Type**

S1/POS	Set ACPI Sleep type is S1. (Default Value)
S3/STR	Set ACPI Sleep type is S3.

- **USB KB/MS Wakeup From S3**

USB KB/MS Wakeup From S3 can be set when ACPI Sleep Type set to S3/STR.

Enabled	Enable USB KB/MS Wakeup From S3.
Disabled	Disable USB KB/MS Wakeup From S3. (Default Value)

- **Power Management / APM**

Enabled	Enable Green & software APM function. (Default Value)
Disabled	Disable Green & software APM function.

- **Video Power Down Mode**

Disabled	Disabled Video Power Down Mode Function.
Suspend	Set Video Power Down Mode to Suspend. (Default Value)
Stand By	Set Video Power Down Mode to Stand By.

- **Hard Disk Power Down Mode**

Disabled	Disabled Hard Disk Power Down Mode Function.
Suspend	Set Hard Disk Power Down Mode to Suspend. (Default Value)
Stand By	Set Hard Disk Power Down Mode to Stand By.

- **Standby Time Out (Minute)**

Disabled	Disabled Standby Time Out Function. (Default Value)
1	Enabled Standby Time Out after 1min.
2	Enabled Standby Time Out after 2min.
4	Enabled Standby Time Out after 4min.
8	Enabled Standby Time Out after 8min.
10	Enabled Standby Time Out after 10min.
20	Enabled Standby Time Out after 20min.
30	Enabled Standby Time Out after 30min.
40	Enabled Standby Time Out after 40min.
50	Enabled Standby Time Out after 50min.
60	Enabled Standby Time Out after 60min.

- **Suspend Time Out (Minute)**

Disabled	Disabled Suspend Time Out Function. (Default Value)
1	Enabled Suspend Time Out after 1min.
2	Enabled Suspend Time Out after 2min.
4	Enabled Suspend Time Out after 4min.
8	Enabled Suspend Time Out after 8min.
10	Enabled Suspend Time Out after 10min.
20	Enabled Suspend Time Out after 20min.
30	Enabled Suspend Time Out after 30min.
40	Enabled Suspend Time Out after 40min.
50	Enabled Suspend Time Out after 50min.
60	Enabled Suspend Time Out after 60min.

- **K/B & PS/2 Mouse Access**

Monitor	Monitor Keyboard & PS/2 Mouse Access. (Default Value)
Ignore	Ignore Keyboard & PS/2 Mouse Access.

- **FDC/LPT/COM Port Access**

Monitor	Monitor FDC/LPT/COM Port Access. (Default Value)
Ignore	Ignore FDC/LPT/COM Port Access.

- **SB/MSS Audio Ports Access**

Monitor	Monitor SB/MSS Audio Ports Access.
Ignore	Ignore SB/ MSS Audio Ports Access. (Default Value)

- **MIDI Ports Access**

Monitor	Monitor MIDI Ports Access.
Ignore	Ignore MIDI Ports Access. (Default Value)

- **ADLIB Ports Access**

Monitor	Monitor ADLIB Ports Access.
Ignore	Ignore ADLIB Ports Access. (Default Value)

- **Primary Master IDE Access**

Monitor	Monitor Primary Master IDE Access. (Default Value)
Ignore	Ignore Primary Master IDE Access.

- **Primary slave IDE Access**

Monitor	Monitor Primary slave IDE Access.
Ignore	Ignore Primary slave IDE Access. (Default Value)

- **Secondary Master IDE Access**

Monitor	Monitor Secondary Master IDE Access. (Default Value)
Ignore	Ignore Secondary Master IDE Access.

- **Secondary slave IDE Access**

Monitor	Monitor Secondary slave IDE Access.
Ignore	Ignore Secondary slave IDE Access. (Default Value)

- PIRQ[A] IRQ Active

Monitor	Monitor PIRQ[A] IRQ Active.
Ignore	Ignore PIRQ[A] IRQ Active. (Default Value)

- PIRQ[B] IRQ Active

Monitor	Monitor PIRQ[B] IRQ Active.
Ignore	Ignore PIRQ[B] IRQ Active. (Default Value)

- PIRQ[C] IRQ Active

Monitor	Monitor PIRQ[C] IRQ Active.
Ignore	Ignore PIRQ[C] IRQ Active. (Default Value)

- PIRQ[D] IRQ Active

Monitor	Monitor PIRQ[D] IRQ Active.
Ignore	Ignore PIRQ[D] IRQ Active. (Default Value)

- System Thermal

Monitor	Monitor System Thermal.
Ignore	Ignore System Thermal. (Default Value)

- Soft-off by Power Button

Instant-off	Soft switch ON/OFF for POWER ON/OFF. (Default Value)
Delay 4 Sec.	Soft switch ON 4sec. for POWER OFF.

- AC Back Function

Last State	Set Restore on AC/Power Loss is Last state mode. (Default Value)
Power Off	Set Restore on AC/Power Loss is Power off.
Power On	Set Restore on AC/Power Loss is Power on.

- Modem USE IRQ

3, 4, (Default Value) 5, 7, N/A
--

- Modem Ring On / Wake On Lan

Disabled	Disabled Modem Ring On / Wake On Lan.
Enabled	Enabled Modem Ring On / Wake On Lan. (Default Value)

- **PME Event Wake Up**

Disabled	Disable PME Event Wake Up. (Default Value)
Enabled	Enabled PME Event Wake Up.

- **RTC Alarm Power On**

You can set "RTC Alarm Power On" item to enabled and key in date/time to power on system.

Disabled	Disable this function. (Default Value)
Enabled	Enable alarm function to POWER ON system.

If RTC Alarm Lead To Power On is Enabled

Alarm Date :	Every Day,1-31
Alarm Hour:	0-23
Alarm Minute :	0-59
Alarm Second :	0-59

PNP/PCI Configuration

AMIBIOS SETUP – PNP / PCI CONFIGURATION	
(C) 1998 American Megatrends, Inc. All Rights Reserved	
Plug and Play Aware O/S	No
Clear NVRAM	No
Primary Graphics Adapter	AGP
PCI VGA Palette Snoop	Disabled
DMA Channel 0	PnP
DMA Channel 1	PnP
DMA Channel 3	PnP
DMA Channel 5	PnP
DMA Channel 6	PnP
DMA Channel 7	PnP
IRQ 3	PCI/PnP
IRQ 4	PCI/PnP
IRQ 5	PCI/PnP
IRQ 7	PCI/PnP
IRQ 9	PCI/PnP
IRQ 10	PCI/PnP
IRQ 11	PCI/PnP
IRQ 14	PCI/PnP
IRQ 15	PCI/PnP
ESC: Quit ↑↓→←: Select Item F1 : Help PU/PD+/-: Modify F5 :Old Values(Shift)F2:Color F6 : Load BIOS Defaults F7 : Load Setup Defaults	

Figure 6: PNP/PCI Configuration

- Plug and Play Aware O/S**

Yes	Enable Plug and Play Aware O/S function.
No	Disable Plug and Play Aware O/S function. (Default Value)

- Clear NVRAM**

Yes	Set Clear NVRAM.
No	Set don't clear NVRAM. (Default Value)

- Primary Graphics Adapter**

AGP	Primary Graphics Adapter From AGP. (Default Value)
PCI	Primary Graphics Adapter From PCI.

- PCI/VGA Palette Snoop**

Enabled	For having Video Card on ISA Bus and VGA Card on PCI Bus.
Disabled	For VGA Card only. (Default Value)

- **DMA Channel(0,1,3,5,6,7)**

ISA/ EISA	The resource is used by Legacy ISA device.
PnP	The resource is used by PnP device.

- **IRQ (3,4,5,7,9, 10,11,14,15), assigned to ("ISA / EISA" or "PCI/PnP")**

ISA/ EISA	The resource is used by Legacy ISA device.
PCI/ PnP	The resource is used by PCI/ PnP device.

Load BIOS Defaults

AMIBIOS SIMPLE SETUP UTILITY-VERSION 1.20 (C) 1998 American Megatrends, Inc. All Rights Reserved	
STANDARD CMOS SETUP	INTEGRATED PERIPHERALS
BIOS FEATURES SETUP	HARDWARE MONITOR SETUP
CHIPSET FEATURES SETUP	SUPERVISOR PASSWORD
POWER MANAGEMENT SETUP	USER PASSWORD
PNP/PCI CONFIGURATION	
LOAD BIOS DEFAULTS	Load BIOS Defaults (Y/N)?
LOAD SETUP DEFAULTS	EXIT WITHOUT SAVING
ESC : Quit ↑↓→← : Select Item (Shift) F2 : Change Color F5 : Old Values F6 : Load BIOS Defaults F7: Load Setup Defaults F10: Save & Exit	
Load BIOS Defaults except Standard CMOS SETUP	

Figure 7: Load BIOS Defaults

- **LOAD BIOS DEFAULTS**

To load BIOS defaults value to CMOS , enter "Y". If not, enter "N".

Load Setup Defaults

AMIBIOS SIMPLE SETUP UTILITY-VERSION 1.20 (C) 1998 American Megatrends, Inc. All Rights Reserved	
STANDARD CMOS SETUP	INTEGRATED PERIPHERALS
BIOS FEATURES SETUP	HARDWARE MONITOR SETUP
CHIPSET FEATURES SETUP	SUPERVISOR PASSWORD
POWER MANAGEMENT SETUP	USER PASSWORD
PNP/PCI CONFIGURATION	LOAD SETUP DEFAULTS
LOAD BIOS DEFAULTS	SAVE & EXIT SETUP
LOAD SETUP DEFAULTS	EXIT WITHOUT SAVING
ESC : Quit ↑↓→← : Select Item (Shift) F2 : Change Color F5 : Old Values F6 : Load BIOS Defaults F7: Load Setup Defaults F10: Save & Exit	
Load Setup Defaults except Standard CMOS SETUP	

Figure 8: Load SETUP Defaults

- **LOAD SETUP DEFAULTS**

To load SETUP defaults value to CMOS , enter "Y". If not, enter "N".

Integrated Peripherals

AMIBIOS SETUP – INTEGRATED PERIPHERALS			
(C) 1998 American Megatrends, Inc. All Rights Reserved			
OnBoard IDE	Both	Mouse PowerOn Function	Disabled
OnBoard AC'97 Audio	Auto		
OnBoard AC'97 Modem	Auto		
OnBoard FDC	Auto		
OnBoard Serial Port A	Auto		
OnBoard Serial Port B	Auto		
Serial Port B Mode	Normal		
IR Duplex Mode	Half Duplex		
IR Pin Select	IRRX/IRTX		
OnBoard CIR Port	Disabled		
CIR IRQ Select	10		
OnBoard Parallel Port	Auto		
Parallel Port Mode	ECP		
Parallel Port IRQ	Auto		
Parallel Port DMA	Auto		
OnBoard Midi Port	330	ESC: Quit	↑↓→←: Select Item
Midi IRQ Select	10	F1 : Help	PU/PD+/-/: Modify
OnBoard Game Port	201	F5 :Old Values(Shift)	F2:Color
Keyboard PowerOn Function	Disabled	F6 : Load BIOS Defaults	
Specific Key for PowerOn	N/A	F7 : Load Setup Defaults	

Figure 9: Integrated Peripherals

- **On Board IDE**

Disabled	Disabled OnBoard IDE.
Both	Set OnBoard IDE is Both. (Default Value)
Primary	Set OnBoard IDE is Primary.
Secondary	Set OnBoard IDE is Secondary.

- **On Board AC'97 Audio**

Auto	Enabled On Board AC'97 Audio. (Default Value)
Disabled	Disabled On Board AC'97 Audio.

- **On Board AC'97 Modem**

Auto	Enabled On Board AC'97 Modem.
Disabled	Disabled On Board AC'97 Modem. (Default Value)

- **OnBoard FDC**

Auto	Set OnBoard FDC is Auto. (Default Value)
Disabled	Disabled OnBoard FDC.
Enabled	Enabled OnBoard FDC.

- **On Board Serial Port A**

Auto	BIOS will automatically setup the port A address. (Default Value)
3F8/COM1	Enable on Board Serial port A and address is 3F8.
2F8/COM2	Enable on Board Serial port A and address is 2F8.
3E8/COM3	Enable on Board Serial port A and address is 3E8.
2E8/COM4	Enable on Board Serial port A and address is 2E8.
Disabled	Disable on Board Serial port A.

- **On Board Serial Port B**

Auto	BIOS will automatically setup the port B address. (Default Value)
3F8/COM1	Enable on Board Serial port B and address is 3F8.
2F8/COM2	Enable on Board Serial port B and address is 2F8.
3E8/COM3	Enable on Board Serial port B and address is 3E8.
2E8/COM4	Enable on Board Serial port B and address is 2E8.
Disabled	Disable on Board Serial port B.

- **Serial Port B Mode**

Normal	Normal operation. (Default Value)
IrDA (1.6 μ S)	Onboard I/O chip supports IRDA (1.6 μ S Baud Red).
IrDA (3/16)	Onboard I/O chip supports IRDA (3/16 Baud Red).
ASKIR	Onboard I/O chip supports ASKIR.

- **IR Duplex Mode**

Half Duplex	IR Function Duplex Half. (Default Value)
Full Duplex	IR Function Duplex Full.

- **IR Pin Select**

IRRX/IRTX	IR Pin Select is IRRX/IRTX. (Default Value)
SINB/SOUTB.	IR Pin Select is SINB/SOUTB.

- **On Board CIR port**

Disabled	Disabled On board CIR port. (Default Value)
Enabled	Enabled On board CIR port.

- **CIR IRQ Select**

IRQ 3 / 4 / 9 / 10 (Default Value) / 11
--

- **On Board Parallel port**

378	Enable On Board LPT port and address is 378.
278	Enable On Board LPT port and address is 278.
3BC	Enable On Board LPT port and address is 3BC.
Auto	Set On Board LPT port is Auto. (Default Value)
Disabled	Disable On Board LPT port.

- **Parallel Port Mode**

EPP	Using Parallel port as Enhanced Parallel Port.
ECP	Using Parallel port as Extended Capabilities Port. (Default Value)
Normal	Normal Operation.

- **Parallel Port IRQ**

7	Set Parallel Port IRQ is 7.
5	Set Parallel Port IRQ is 5.
Auto	Set Parallel Port IRQ is Auto. (Default Value)

- **Parallel Port DMA**

3	Set Parallel Port DMA is 3.
1	Set Parallel Port DMA is 1.
Auto	Set Parallel Port DMA is Auto. (Default Value)

- **On Board Midi Port**

Disabled	Disabled On Board Midi Port.
300	Set On Board Midi Port is 300.
330	Set On Board Midi Port is 330. (Default Value)

- **Midi IRQ Select**

IRQ 9 / 5 / 7 / 10 (Default Value)

- **On Board Game Port**

Disabled	Disabled On Board game port.
201	Set onboard game port is 201. (Default Value)
209	Set onboard game port is 209.

- **Keyboard Power On Function**

Disabled	Disable this function. (Default Value)
Specific Key	Set specific key to power on by keyboard.
Any Key	Set any key to power on the system.

- **Specific Key for Power On**

N/A	Disable this function. (Default Value)
Password	Enter from 1 to 5 characters to set the Keyboard Power On Password .

- **Mouse Power On Function**

Disabled	Disable this function. (Default Value)
Left-button	Double click twice on PS/2 left button.
Right-button	Double click twice on PS/2 right button.

Hardware Monitor Setup

AMIBIOS SETUP – HARDWARE MONITOR SETUP			
(C) 1998 American Megatrends, Inc. All Rights Reserved			
ACPI Shut Down Temp.	75°C/167°F	Battery	3.056 V
CPU Temp. Alarm	70°C/158°F	+5V SB	4.896 V
CPU Fan Fail Alarm	No		
Power Fan Fail Alarm	No		
System Fan Fail Alarm	No		
Reset Case Open Status	No		
Case Status	Closed		
Current CPU Temp.	35°C/ 95°F		
Current System Temp.	32°C/ 89°F		
Current CPU Fan Speed	5273 RPM		
Current System Fan Speed	0 RPM		
Current Power Fan Speed	0 RPM		
CPU VID	2.05 V		
Vcore	2.016 V		
Vtt	1.488 V		
Vio	3.312 V	ESC: Quit	↑↓→←: Select Item
+5.000V	5.030 V	F1 : Help	PU/PD+/-: Modify
+12.000V	11.923 V	F5 :Old Values(Shift)	F2:Color
-12.000V	-11.579 V	F6 : Load BIOS Defaults	
-5.000V	-4.675 V	F7 : Load Setup Defaults	

Figure 10: Hardware Monitor Setup

- **ACPI Shutdown Temp.**

(This function will be effective only for the operating systems that support ACPI Function.)

Disabled	Normal Operation.
60°C / 140°F	Monitor CPU Temp. at 60°C / 140°F, if Temp. > 60°C / 140°F system will automatically power off .
65°C / 149°F	Monitor CPU Temp. at 65°C / 149°F, if Temp. > 65°C / 149°F system will automatically power off .
70°C / 158°F	Monitor CPU Temp. at 70°C / 158°F, if Temp. > 70°C / 158°F system will automatically power off .
75°C / 167°F	Monitor CPU Temp. at 75°C / 167°F, if Temp. > 75°C / 167°F system will automatically power off. (Default Value)

- **CPU Temp. Alarm**

65°C / 149°F	Monitor CPU Temp. at 65°C / 149°F.
70°C / 158°F	Monitor CPU Temp. at 70°C / 158°F. (Default Value)
75°C / 167°F	Monitor CPU Temp. at 75°C / 167°F.
Disabled	Disabled this function.

- **Fan Fail Alarm**

CPU / Power / System

No	Fan Fail Alarm Function Disabled. (Default Value)
Yes	Fan Fail Alarm Function Enabled.

- **Reset Case Open Status**

- **Case Opened**

If the case is closed, "Case Opened" will show "No".

If the case have been opened, "Case Opened" will show "Yes" .

If you want to reset "Case Opened" value, set "Reset Case Open Status" to "Yes" and save CMOS, your computer will restart.

- **Current CPU Tempe.**

Detect CPU Temp. automatically.

- **Current System Tempe.**

Detect System Temp. automatically.

- **CPU FAN / Power FAN / System FAN Speed (RPM)**

Detect Fan speed status automatically.

- **Current CPU VID / VCORE / Vtt / Vio / ±12V / ±5V /Battery / +5VSB**

Detect system's voltage status automatically.

Supervisor / User Password

When you select this function, the following message will appear at the center of the screen to assist you in creating a password.

AMIBIOS SIMPLE SETUP UTILITY-VERSION 1.20 (C) 1998 American Megatrends, Inc. All Rights Reserved	
STANDARD CMOS SETUP	INTEGRATED PERIPHERALS
BIOS FEATURES SETUP	HARDWARE MONITOR SETUP
CHIPSET FEATURES SETUP	SUPERVISOR PASSWORD
POWER MANAGEMENT SETUP	USER PASSWORD
PNP/PCI CONFIGURATION	IDE HDD AUTO DETECTION
LOAD BIOS DEFAULT	Enter new supervisor password:
LOAD SETUP DEFAULTS	EXIT WITHOUT SAVING
ESC : Quit ↑↓→← : Select Item (Shift) F2 : Change Color F5 : Old Values F6 : Load BIOS Defaults F7: Load Setup Defaults F10: Save & Exit	
Change / Set / Disable Password	

Figure 11: Password Setting

Type the password, up to eight characters, and press <Enter>. The password typed now will clear the previously entered password from CMOS memory. You will be asked to confirm the password. Type the password again and press <Enter>.

To disable password, just press <Enter> when you are prompted to enter password. A message "PASSWORD DISABLED" will appear to confirm the password being disabled. Once the password is disabled, the system will boot and you can enter Setup freely.

If you select Always at Security Option in BIOS Features Setup Menu, you will be prompted for the password every time the system is rebooted or any time you try to enter Setup Menu. If you select Setup at Security Option in BIOS Features Setup Menu, you will be prompted only when you try to enter Setup.

IDE HDD AUTO Detection

AMIBIOS SETUP – STANDARD CMOS SETUP (C) 1998 American Megatrends, Inc. All Rights Reserved	
Date (mm/dd/yyyy) : Fri Dec 25, 1998 Time (hh/mm/ss) : 10:36:24 TYPE SIZE CYLS HEAD PRECOMP LANDZ SECTOR MODE	
Pri Master : Auto Pri Slave : Auto Sec Master: Auto Sec Slave : Auto	
Floppy Drive A: 1.44 MB 3 ½ Floppy Driver B: Not Installed Boot Sector Virus Protection : Disabled	Base Memory : 640 kb Other Memory: 384 kb Extended Memory: 31mb Total Memory: 32mb
Month: Jan – Dec Day: 01 – 31 Year : 1980– 2099	ESC : Exit ↑↓ : Select Item PU/PD/+/- : Modify (Shift)F2 : Color

Figure 12: IDE HDD Auto Detection

Type "Y" will accept the H.D.D. parameter reported by BIOS.

Type "N" will keep the old H.D.D. parameter setup. If the hard disk cylinder number is over 1024, then the user can select LBA mode or LARGER mode for DOS partition larger than 528 MB.

Save & Exit Setup

AMIBIOS SIMPLE SETUP UTILITY-VERSION 1.20 (C) 1998 American Megatrends, Inc. All Rights Reserved	
STANDARD CMOS SETUP	INTEGRATED PERIPHERALS
BIOS FEATURES SETUP	HARDWARE MONITOR SETUP
CHIPSET FEATURES SETUP	SUPERVISOR PASSWORD
POWER MANAGEMENT SETUP	USER PASSWORD
PNP/PCI CONFIGURATION	IDE HDD AUTO DETECTION
LOAD BIOS DEFAULTS	
LOAD SETUP DEFAULTS	
SAVE to CMOS and EXIT(Y/N)? Y	
ESC : Quit ↑↓→← : Select Item (Shift) F2 : Change Color F5 : Old Values F6 : Load BIOS Defaults F7: Load Setup Defaults F10: Save & Exit	
Save Data to CMOS & Exit SETUP	

Figure 13: Save & Exit Setup

Type "Y" will quit the Setup Utility and save the user setup value to RTC CMOS.

Type "N" will return to Setup Utility.

Exit Without Saving

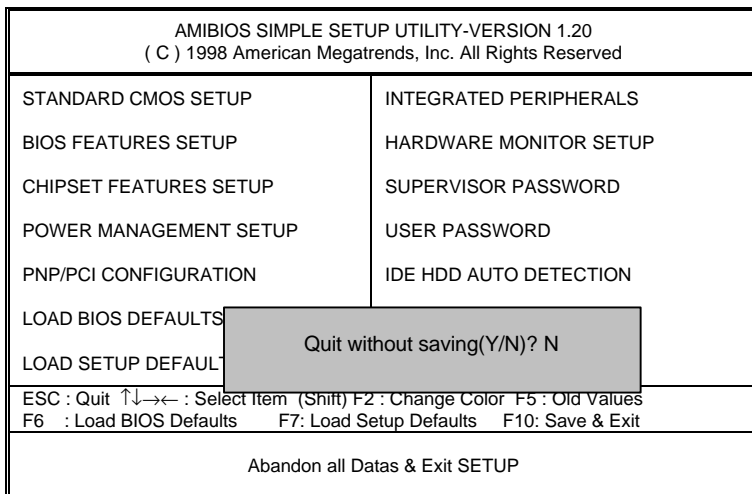

Figure 14: Exit Without Saving

Type "Y" will quit the Setup Utility and save the user setup value to RTC CMOS.

Type "N" will return to Setup Utility.

Appendix

Appendix A : AU8810 Driver Installation

A. DRIVER INSTALLATION

If you have older drivers in your system, please uninstall them first as described in Section C below.

1. Power on the system, placing the "Intel chipset Series Mainboard Utility CD" in the CD-ROM drive.
2. During the load process, Windows 95/98 should detect the Vortex PCI board and display a message such as "New Hardware Found". If Windows prompts you for the drivers of the "PCI Multimedia Audio Device", then select "Driver Disk Provided by Manufacturer" Select the Vortex CD-ROM's directory.

Note: Some Windows 95 versions (OSR2) do not show this prompt. Instead, they ask whether to search the diskette and CD-ROM drives for the appropriate drivers.

Installed drivers may include Vortex PCI audio, Vortex wavetable, Vortex mixer, DOS modem port, Vortex gameport interface, Vortex MPU401 interface, and Vortex Sound Blaster emulation.

Depending on the version of Windows 95 and the configuration of the system, you may be prompted to provide several file locations. Here are the CD-ROMs and directory locations for which you may be prompted:

Vortex Installation & Driver Disk	\aureal\win9X
Windows 95/98 Installation Disk	\aureal\win9X
Microsoft DirectX	\Utility\directx\dxsetup
Vortex Application Setup	\aureal\win9X
PCI Multifunction Audio Device	\aureal\win9X

B. UNINSTALLING WINDOWS 95/98 DRIVERS

To uninstall the Vortex software, you can use the following procedure:

1. Open to the Windows 95/98 Device Manager (right-click on "My Computer" and select "Properties").

6CXC/6CXC-1 Motherboard

2. Open the "Multifunction Adapters" tree and select "Vortex Multifunction PCI Platform"
3. Press the "Remove" button at the bottom of the Device Manager window pane.
4. The drivers are now removed from memory, but are still on the hard disk. To delete the files from the hard disk:
 - a. Open the Windows 95/98 control panel's "Add/Remove Programs" applet.
 - b. To remove the drivers, double-click "Aureal Vortex". A Vortex uninstaller application starts.
 - c. To remove the demo applications, double-click "Aureal Vortex Applications". There is no need to reboot the computer.

For Technical Support please contact your board manufacturer.

Aureal, A3D, A3D-I, A3D-Interactive, and the Aureal logo are trademarks and Vortex is a registered trademark of Aureal Semiconductor Inc.

All other trademarks are owned their respective owners.

Appendix B : BIOS Flash Procedure

BIOS update procedure:

- ✓ Please check your BIOS vendor (AMI or AWARD) on the motherboard.
- ✓ It is recommended you copy the AWDFlash.exe or AMIFlash.exe in driver CD (D:\>Utility\BIOSFlash) and the BIOS binary files into the directory you made in your hard disk. i.e.C:\>Utility\ (C:\>Utility : denotes the driver and the directory where you put the flash utilities and BIOS file in.)
- ✓ Restart your computer into MS-DOS mode or command prompt only for Win95/98, go into the directory where the new BIOS file are located use the utility AWDFlash.exe or AMIFlash.exe to update the BIOS.
- ✓ Type the following command once you have enter the directory where all the files are located
C:\utility\ AWDFlash or AMIFlash <filename of the BIOS binary file intended for flashing>
- ✓ Once the process is finished, reboot the system

● Note: Please download the newest BIOS from our website (www.gigabyte.com.tw) or contact your local dealer for the file.

Appendix C: Acronyms

Acor.	Meaning
ACPI	Advanced Configuration and Power Interface
POST	Power-On Self Test
LAN	Local Area Network
ECP	Extended Capabilities Port
APM	Advanced Power Management
DMA	Direct Memory Access
MHz	Megahertz
ESCD	Extended System Configuration Data
CPU	Central Processing Unit
SMP	Symmetric Multi-Processing
USB	Universal Serial Bus
OS	Operating System
ECC	Error Checking and Correcting
IDE	Integrated Dual Channel Enhanced
SCI	Special Circumstance Instructions
LBA	Logical Block Addressing
EMC	Electromagnetic Compatibility
BIOS	Basic Input / Output System
SMI	System Management Interrupt
IRQ	Interrupt Request
NIC	Network Interface Card
A.G.P.	Accelerated Graphics Port
S.E.C.C.	Single Edge Contact Cartridge
LED	Light Emitting Diode
EPP	Enhanced Parallel Port
CMOS	Complementary Metal Oxide Semiconductor
I/O	Input / Output
ESD	Electrostatic DISCHARGE
OEM	Original Equipment Manufacturer
SRAM	Static Random Access Memory
VID	Voltage ID
DMI	Desktop Management Interface
MIDI	Musical Interface Digital Interface
IOAPIC	Input Output Advanced Programmable Input Controller
DIMM	Dual Inline Memory Module
DRAM	Dynamic Random Access Memory
PAC	PCI A.G.P. Controller
AMR	Audio Modem Riser

To be continued...

6CXC/6CXC-1 Motherboard

Acor.	Meaning
PCI	Peripheral Component Interconnect
RIMM	Rambus in-line Memory Module
DRM	Dual Retention Mechanism
ISA	Industry Standard Architecture
MTH	Memory Translation Hub
CRIMM	Continuity RIMM