

6VMA

USER'S MANUAL

- 1. System power on by PS/2 Mouse: First, enable this function in CMOS Setup, then you can power on the system by double clicking the right or left button of your PS/2 Mouse.**
- 2. System power on by Keyboard: If your ATX power supply supports larger than 300 mA 5V Stand-By current(dependent on the specification of keyboards), you can power on your system by entering password from the Keyboard after setting the "Keyboard power on" jumper (JP1) and password in CMOS Setup.**
- 3. Support Modem Ring-On. (Include internal Modem and external modem on COM A and COM B)**
- 4. Support Wake-up On LAN. (Your ATX power supply must support larger than 720 mA 5V Stand-By current)**
- 5. ESS SOLO 1 PCI Sound Onboard.(Optional)**

**For Intel Pentium® II / III / Celeron™ Processor MAINBOARD
REV. 1.2 First Edition
R-12-01-090915**

The author assumes no responsibility for any errors or omissions that may appear in this document nor does it make a commitment to update the information contained herein.

Third-party brands and names are the property of their respective owners.

Sound Blaster is a registered trademark of Creative Technology Ltd in the United States and certain other countries. Sound Blaster-LINK and SB-LINK are trademarks of Creative Technology Ltd.

September 15, 1999 Taipei, Taiwan

I. Quick Installation Guide :**CPU SPEED SETUP**

The default system bus speed is set 66/100MHz (**SW2**). The user can change the DIP SWITCH (**SW1**) selection to set up the CPU speed for 233 - 650MHz processor.

⚠ The CPU speed must match with the frequency RATIO. It will cause system hanging up if the frequency RATIO is higher than that of CPU.

SW1:

CLK RATIO	1	2	3	4
X3	ON	OFF	ON	ON
X3.5	OFF	OFF	ON	ON
X4	ON	ON	OFF	ON
X4.5	OFF	ON	OFF	ON
X5	ON	OFF	OFF	ON
X5.5	OFF	OFF	OFF	ON
X6	ON	ON	ON	OFF
X6.5	OFF	ON	ON	OFF
X 7	ON	OFF	ON	OFF
X 7.5	OFF	OFF	ON	OFF
X 8	ON	ON	OFF	OFF
X 8.5	OFF	ON	OFF	OFF
X 9	ON	OFF	OFF	OFF
X 9.5	OFF	OFF	OFF	OFF

SW2:

CPU	1	2	3	4
66	ON	OFF	OFF	ON
75	ON	ON	OFF	ON
83	ON	OFF	ON	ON
100	OFF	OFF	OFF	OFF
112	OFF	ON	OFF	OFF
133	OFF	OFF	ON	OFF

◆Note: It's strongly recommended that set the system speed according to

your hardware configuration: CPU, SDRAM, Cards, etc.

The black part in the picture is the white extruding piece of the DIP switch.

1. Pentium® II / Celeron™ 233 MHz / 66MHz FSB

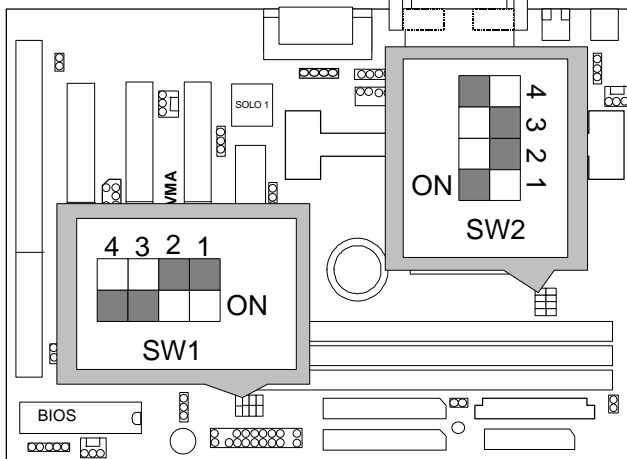

2. Pentium® II / Celeron™ 266MHz / 66MHz FSB

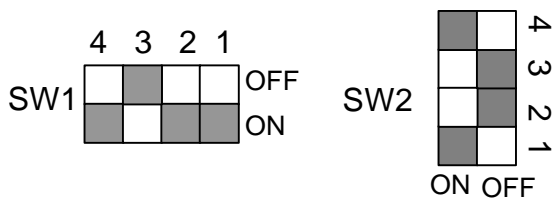

3. Pentium® II/Celeron™ 300MHz /Celeron™ 300A MHz /66MHz FSB

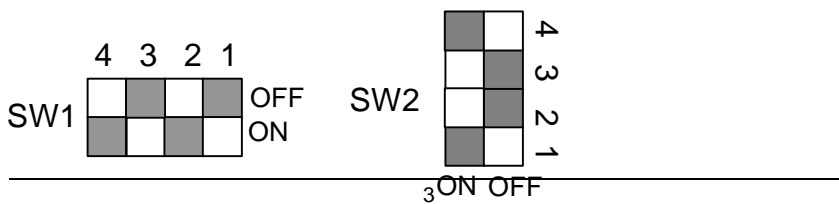

4. Pentium® II / Celeron™ 333MHz / 66MHz FSB

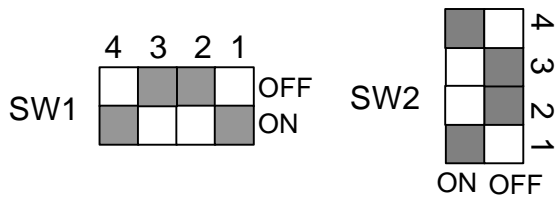

5. Pentium® II / Celeron™ 366 MHz / 66MHz FSB

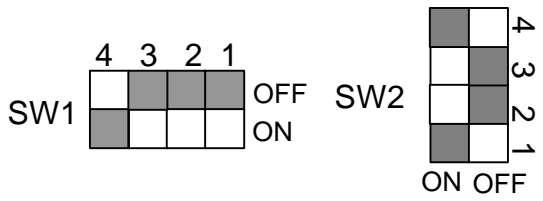

6. Pentium® II / Celeron™ 400 MHz / 66MHz FSB

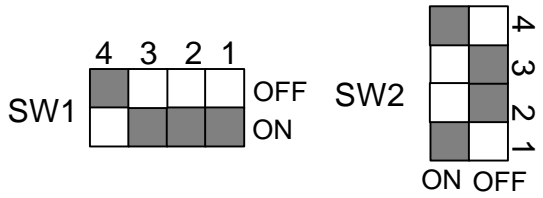

7. Pentium® II / Celeron™ 433 MHz / 66MHz FSB

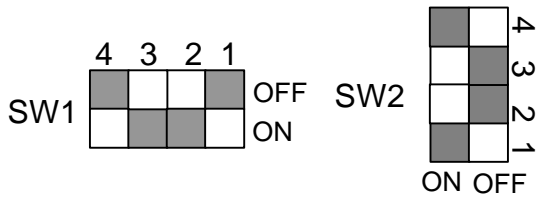

8. Pentium® II 350MHz / 100MHz FSB

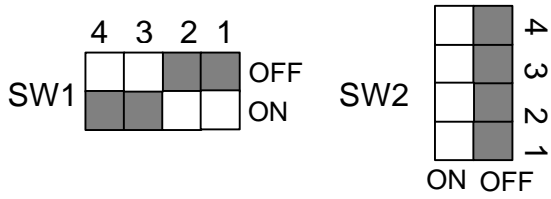

9. Pentium® II 400MHz / 100MHz FSB

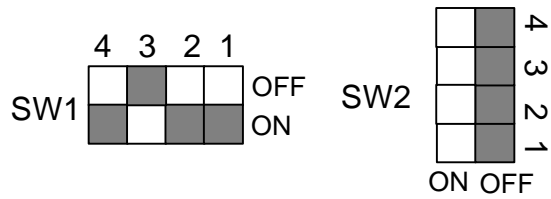

10. Pentium® III 450MHz / 100MHz FSB

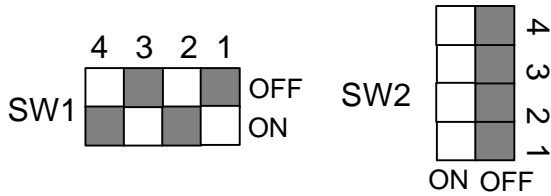

11. Pentium® III 500MHz / 100MHz FSB

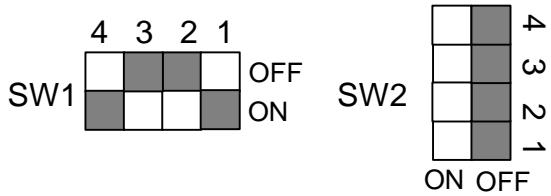

12. Pentium® III 550MHz / 100MHz FSB

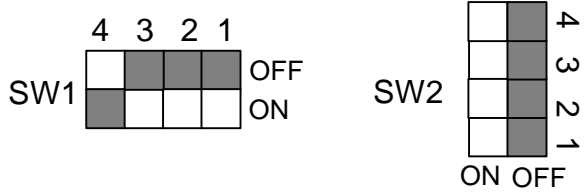

13. Pentium® III 600MHz / 100MHz FSB

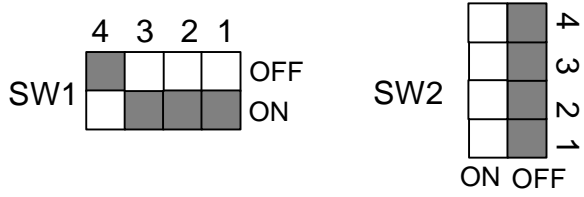

14. Pentium® III 650MHz / 100MHz FSB

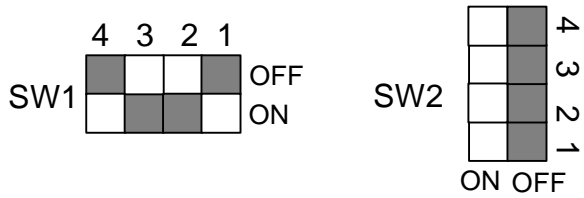

II. Jumper setting :

GN : Green Function Switch

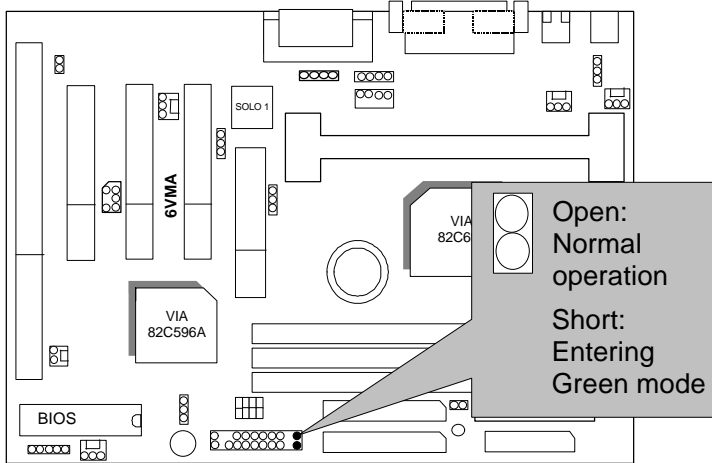

GD : Green Function LED

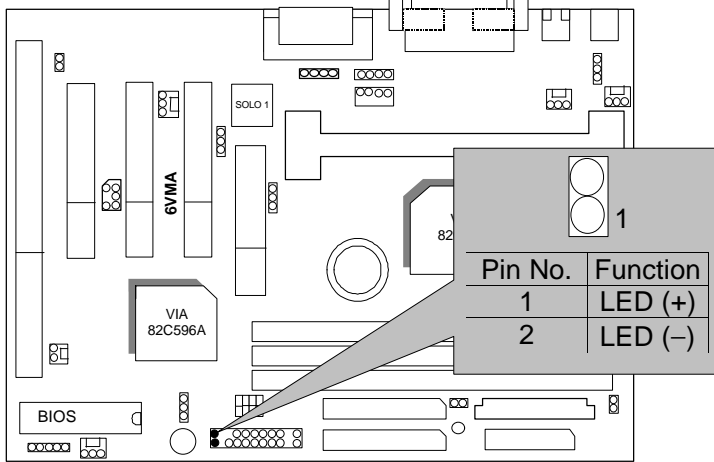

HD : IDE Hard Disk Active LED

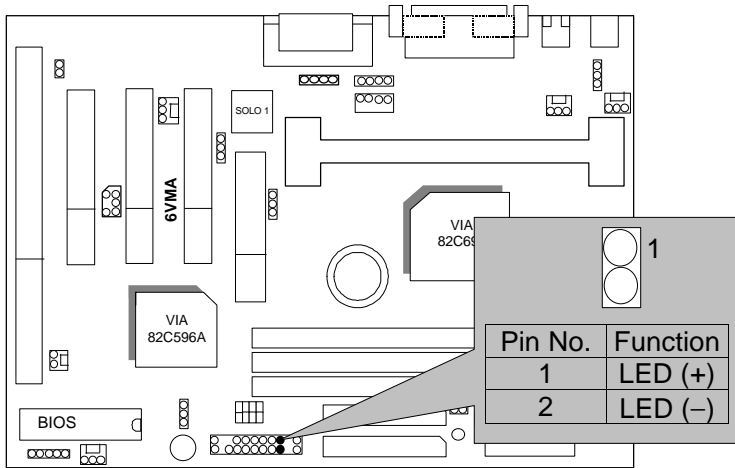

RES : Reset Switch

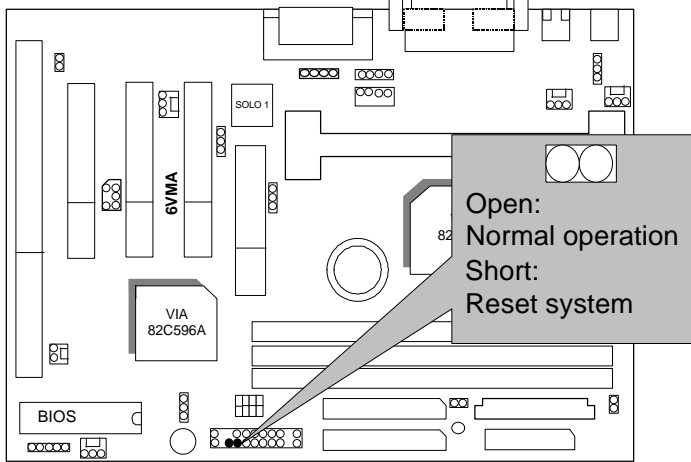

SPK : External Speaker/ Internal Buzzer Connector

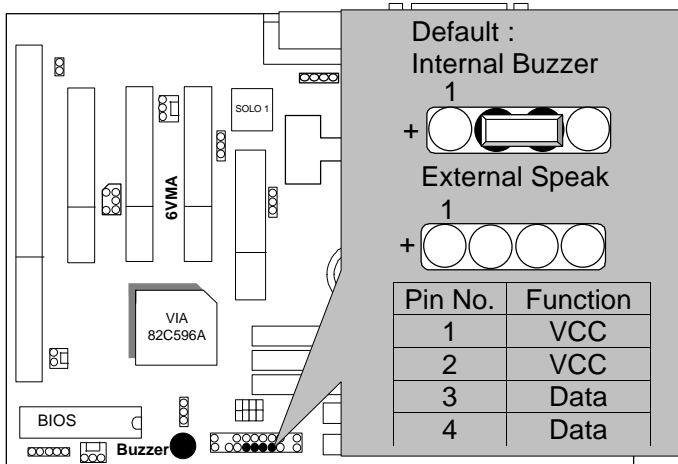

JP21 : Internal Buzzer Connector

(This function is support in PCB version 1.2 and above)

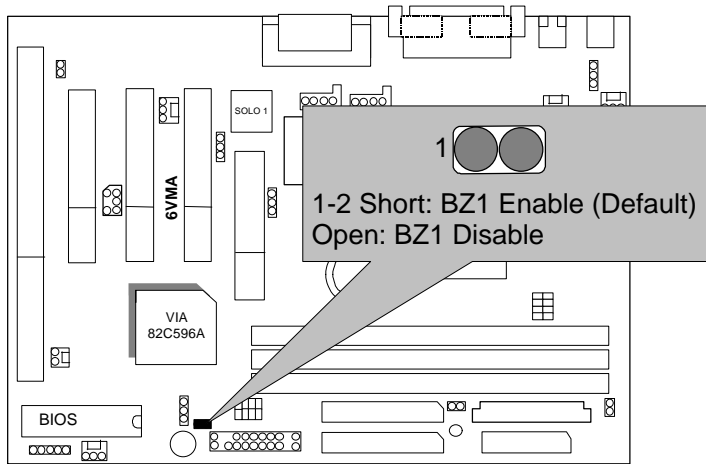

PWR : Power LED Connector (as 3 steps ACPI LED)

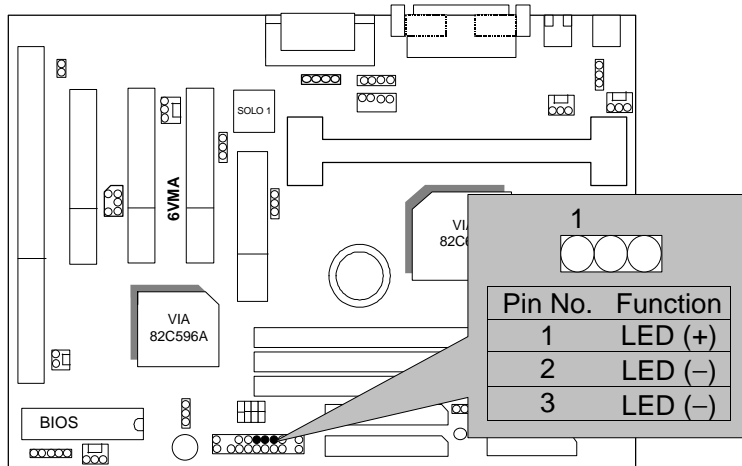

PW : Soft Power Connector

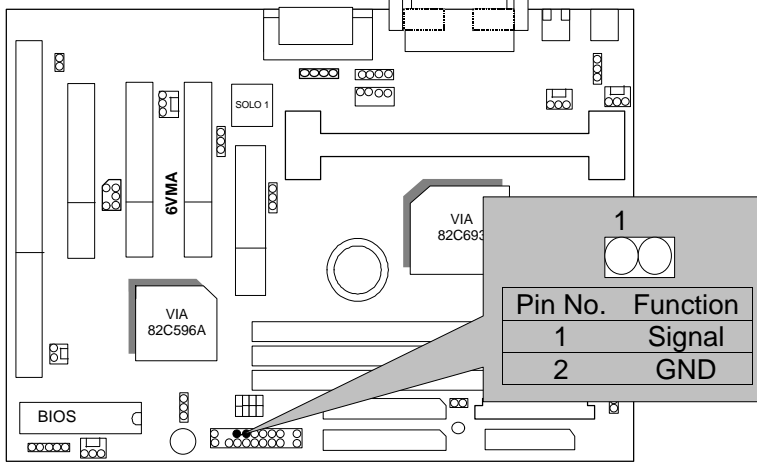

IR : Infrared Connector (Optional)

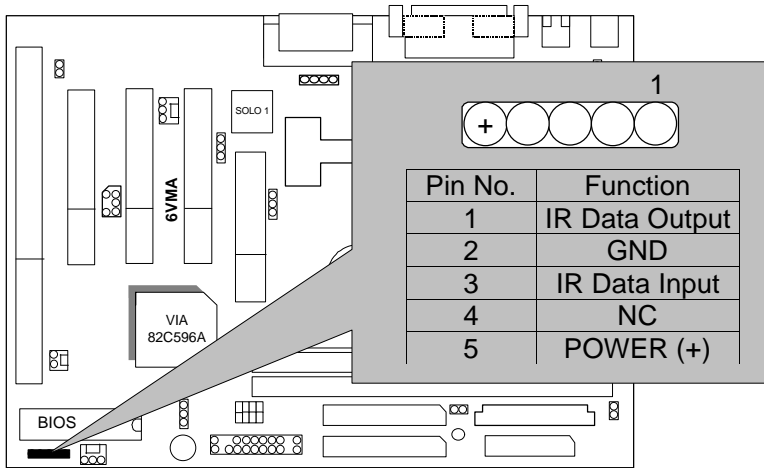

JP14: CLEAR CMOS FUNCTION

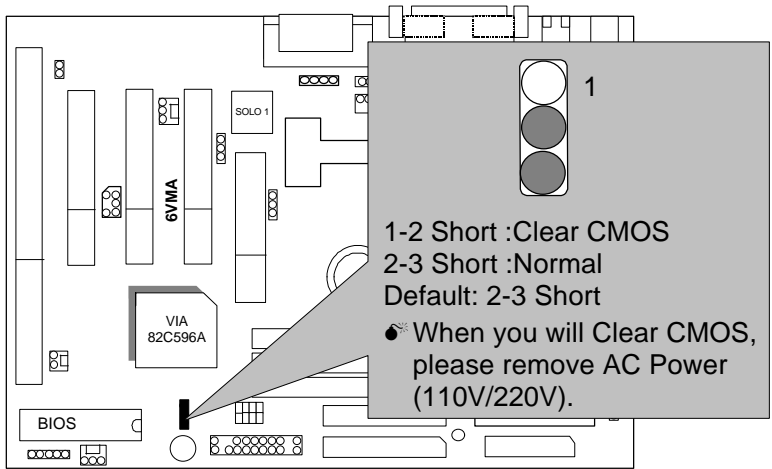

PS/2 Mouse / Keyboard Connector

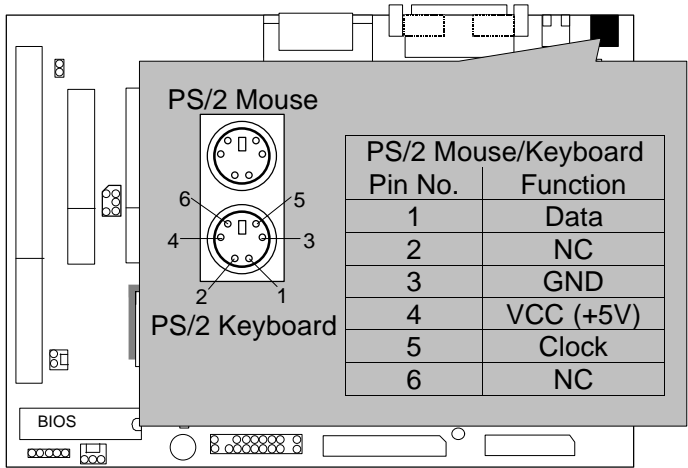

CPU FAN : CPU Cooling Fan Power Connector

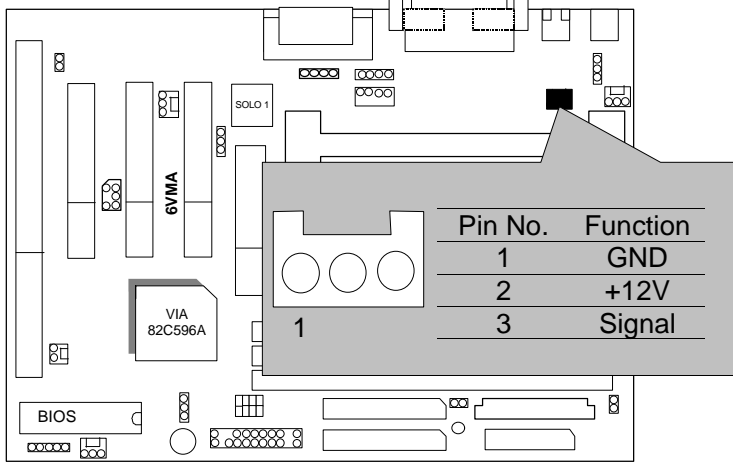

Power FAN : Power Fan Power Connector

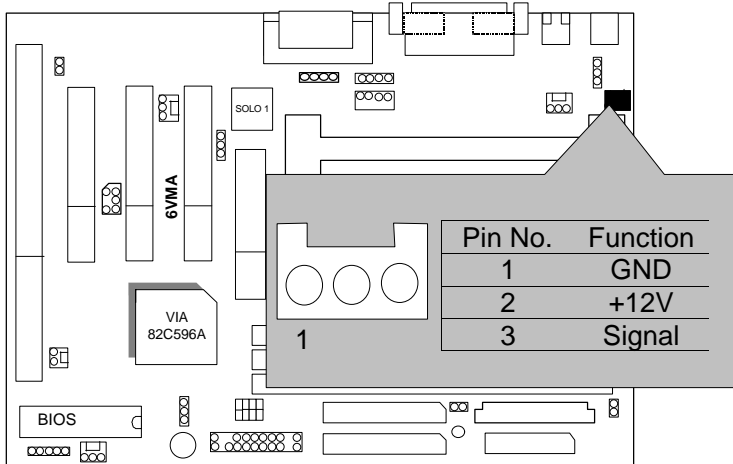

System FAN : System Fan Power Connector

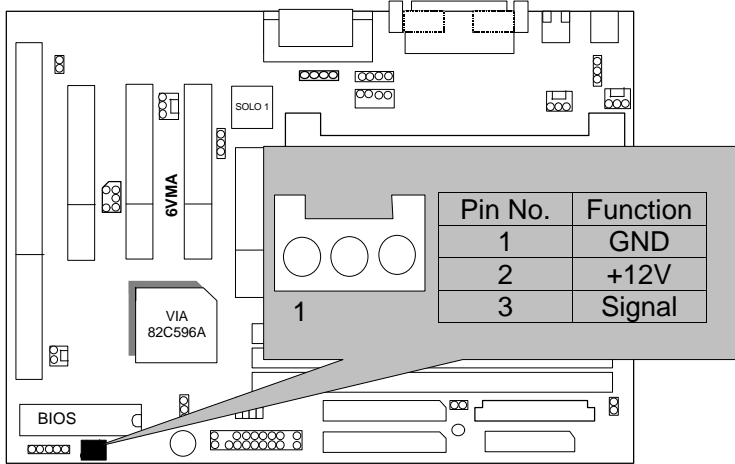

IDE1: For Primary IDE port

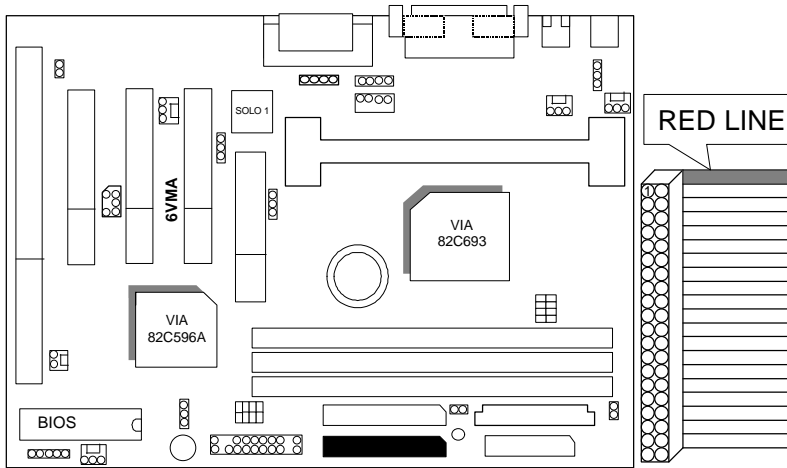

IDE2: For Secondary IDE port

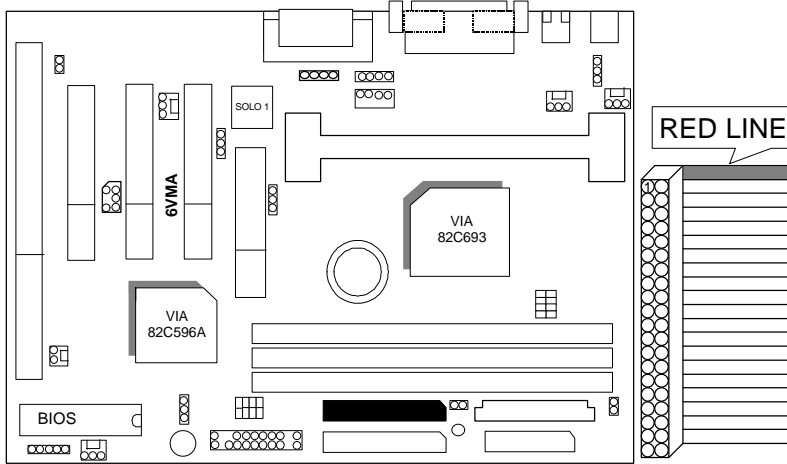

FLOPPY : FLOPPY PORT

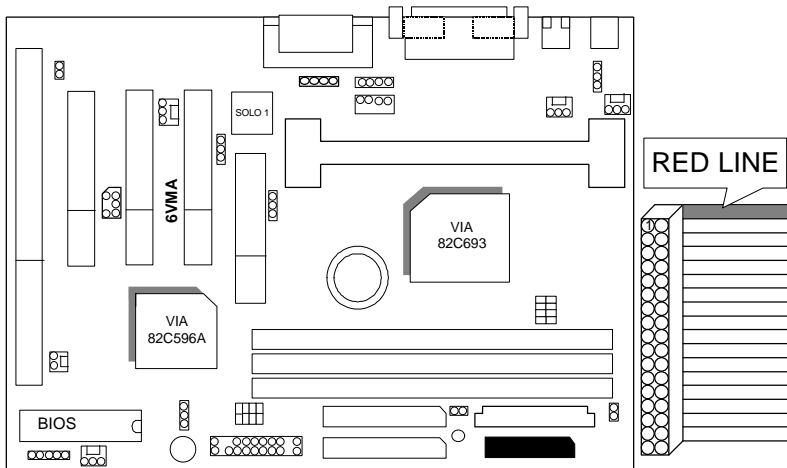

ATX POWER : ATX POWER Connector

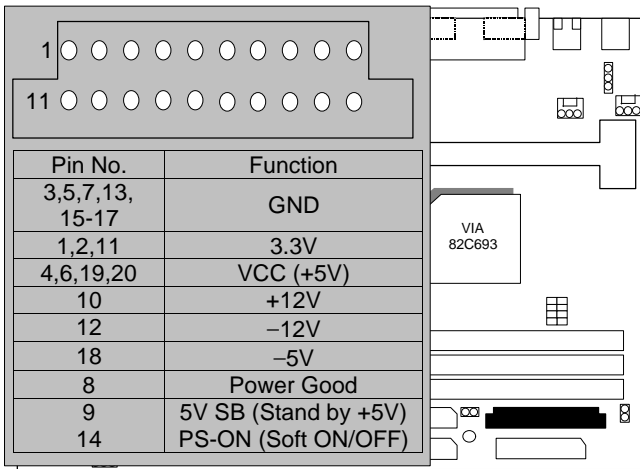

LPT PORT / COM A / COM B

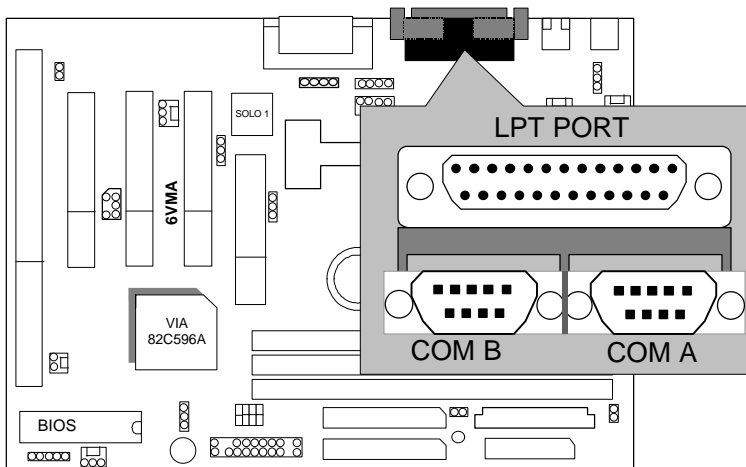

GAME & AUDIO PORT (Optional)

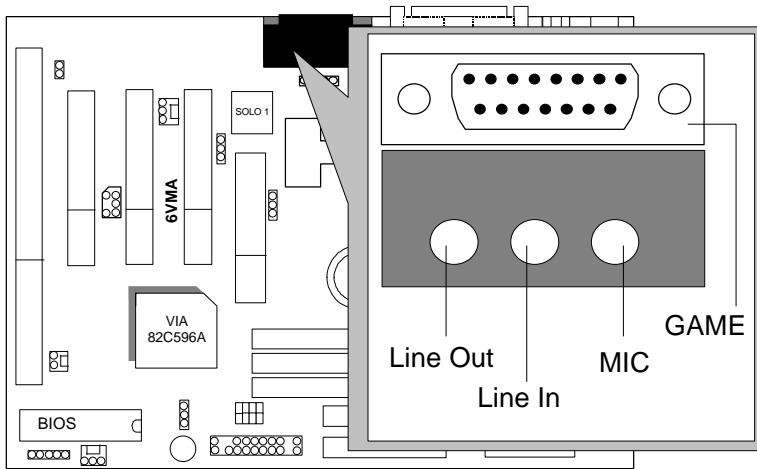

JP1 : Keyboard Power On

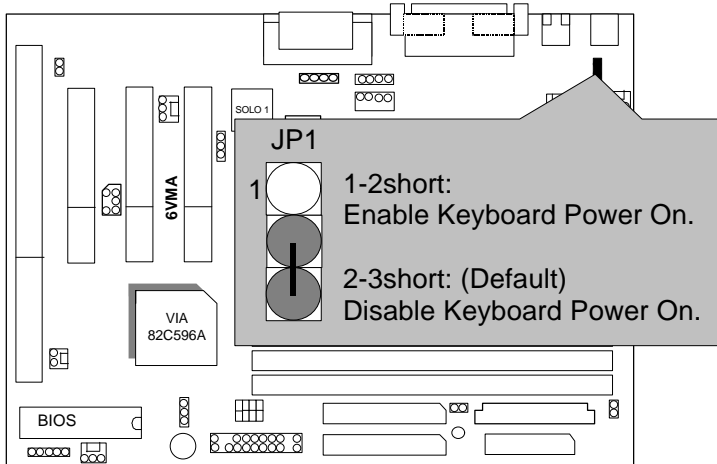

USB: USB Port

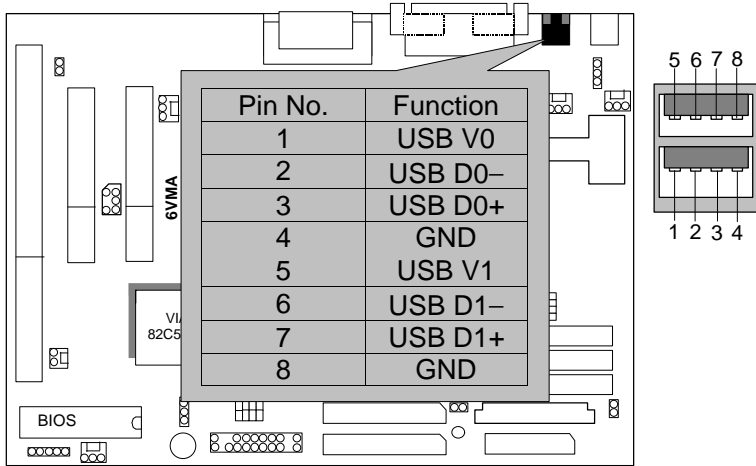

JP7: Wake on LAN

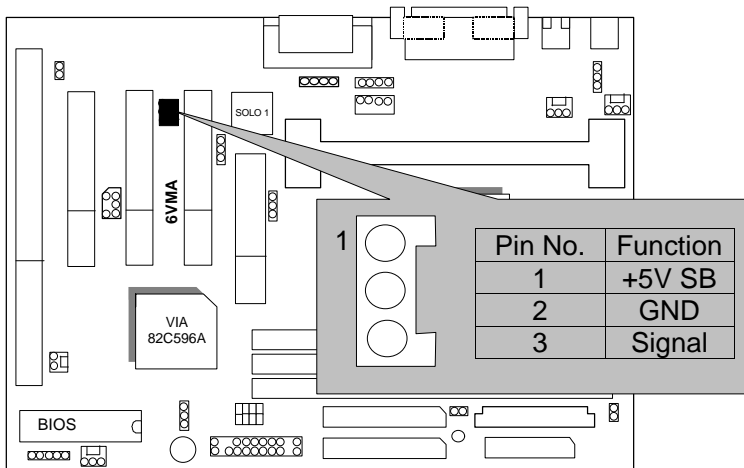

JP18: Onboard Sound Function Selection (Optional)

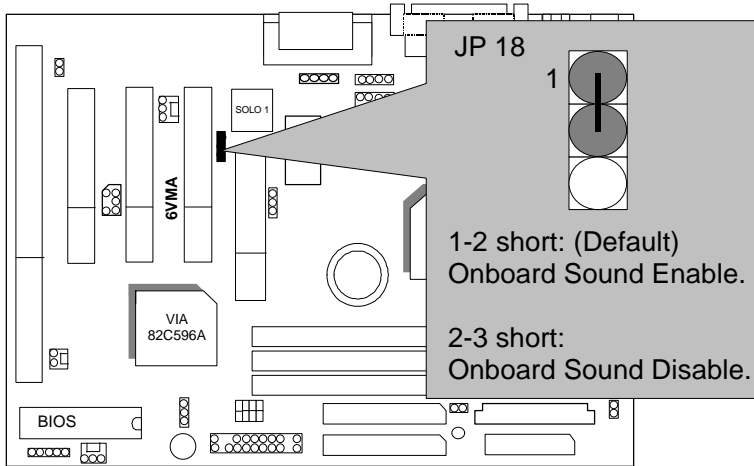

CN6 & JP5: CD Audio Line In (Optional)

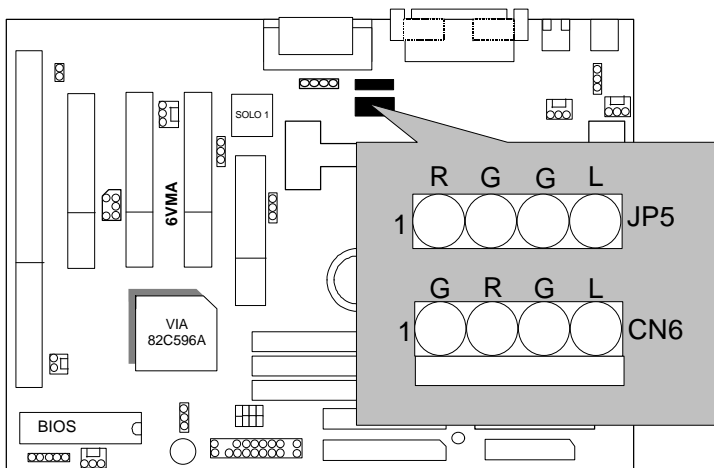

JP5:CD Audio Line In (Optional)

(This function is support in PCB version 1.2 and above)

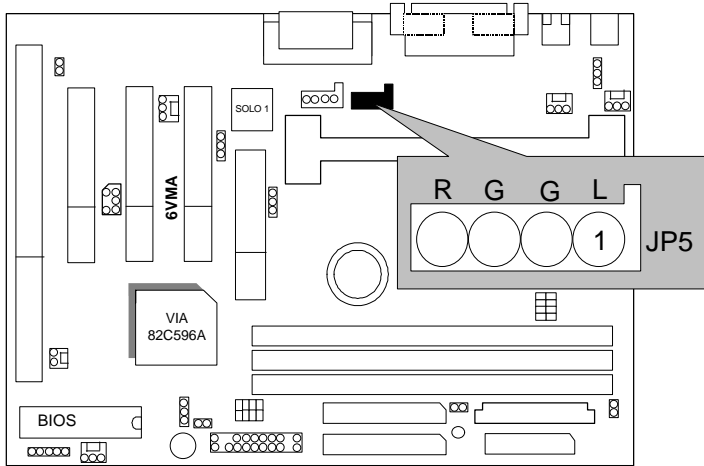

J11:Internal Modem Card Ring PWR On

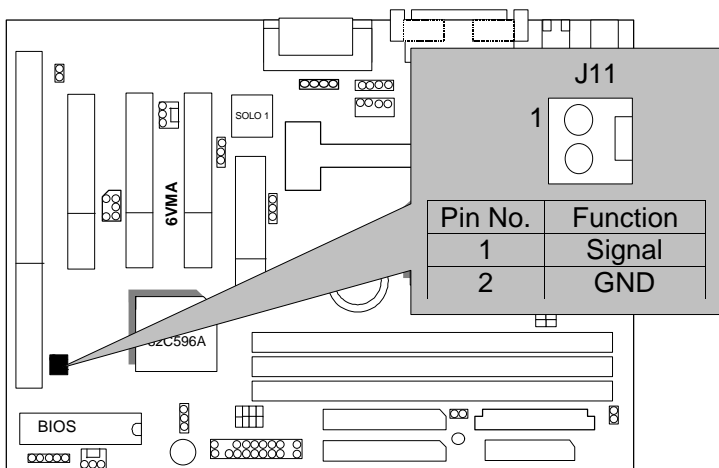

JP13 : Suspend To RAM Function (Optional)

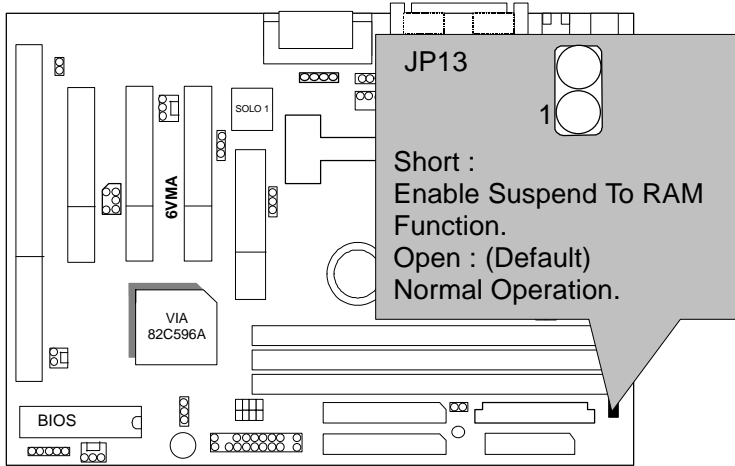

● When STR function is Enabled, please do not unplug the SDRAM modules, for it will burn the SDRAMs and mainboard .

● **Support under Windows 98 ACPI O.S.**

JP15: STR LED Connector (Optional)

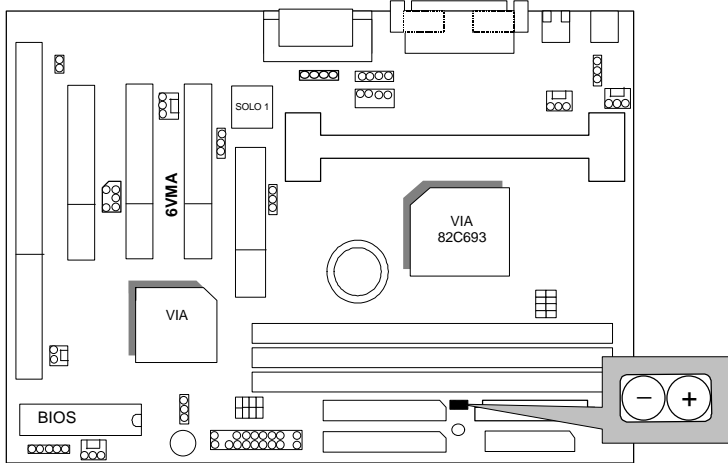

LED 1: DRAM LED (Optional)

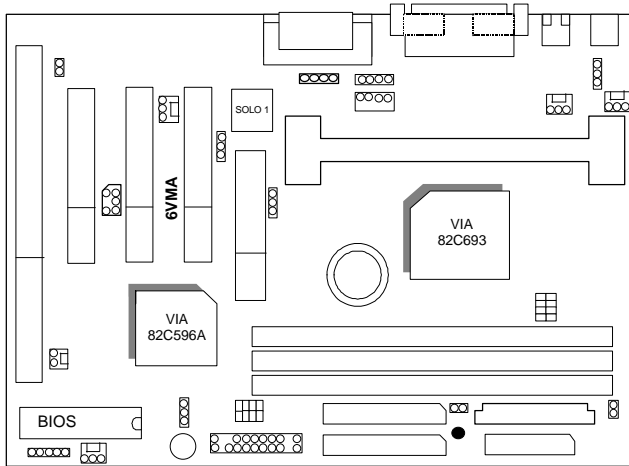

● When RAM LED is on, please do not unplug the SDRAM modules.

JP11: System Acceleration

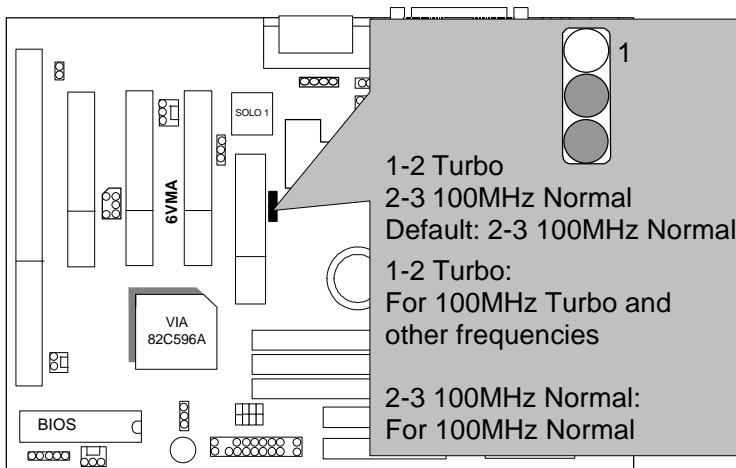

JP10 : CASE OPEN (Optional)

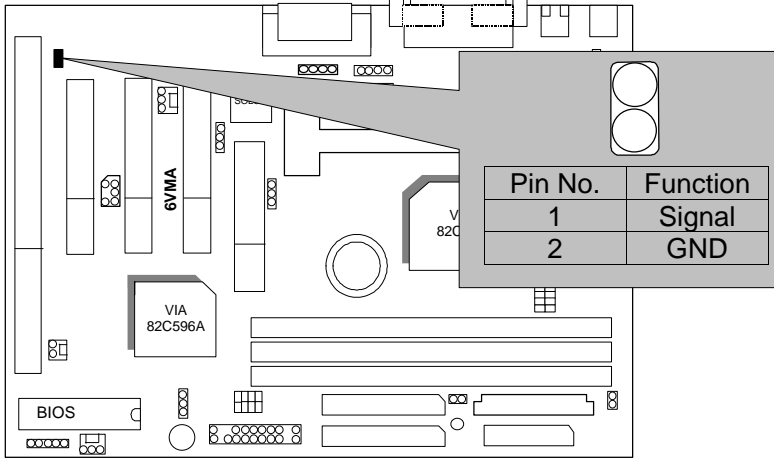

TEL :The Connector is for Modem with internal Voice Connector (Optional)

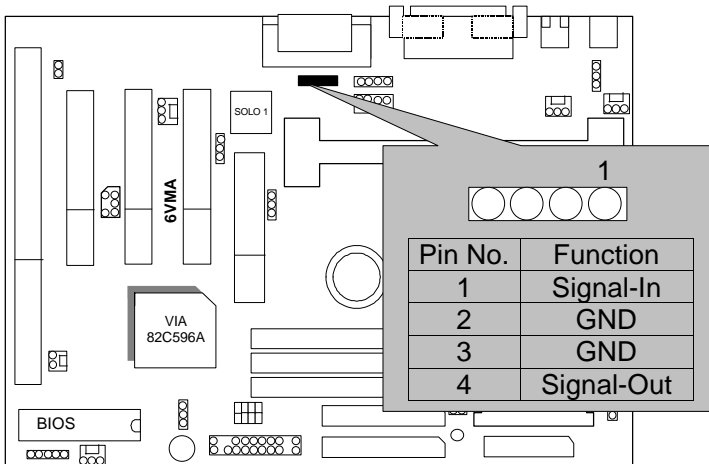

TEL :The Connector is for Modem with internal Voice Connector
 (This function is support in PCB version 1.2 and above)
 (Optional)

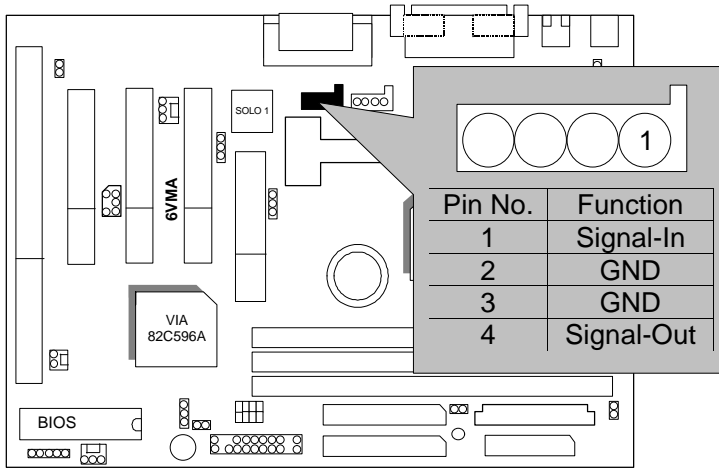

JP10 : SB-LINK (Creative PCI Sound Card Support) (Optional)

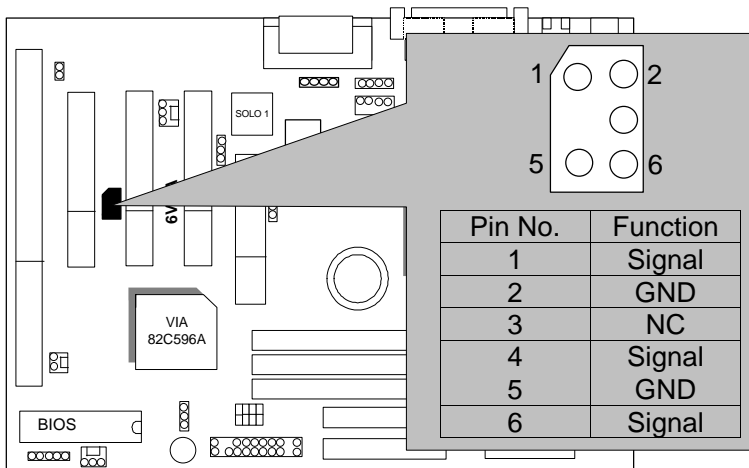

BAT1:For Battery

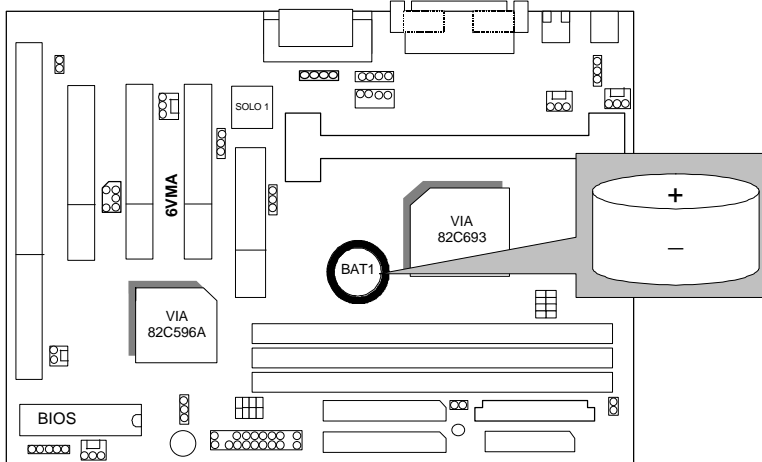

- ⚠ Danger of explosion if battery is incorrectly replaced.
- ⚠ Replace only with the same or equivalent type recommended by the manufacturer.
- ⚠ Dispose of used batteries according to the manufacturer's instructions.

III. Top Performance Test Setting:

The following performance data list is the testing results of some popular benchmark testing programs.

Users have to modify the value for each item in chipset features as follow for top performance setting.

```
ROM PCI/ISA BIOS (2A6LGG0G)
CHIPSET FEATURES SETUP
AWARD SOFTWARE, INC.

Bank 0/1 DRAM Timing      : Turbo
Bank 2/3 DRAM Timing      : Turbo
Bank 4/5 DRAM Timing      : Turbo
SDRAM Cycle Length        : 2
DRAM Clock                 : 66 MHz
Memory Hole                : Disabled
Read Around write         : Disabled
Concurrent PCI/Host       : Disabled
System BIOS Cacheable     : Disabled
Video RAM Cacheable       : Disabled
AGP Aperture Size         : 64M
AGP-2X Mode               : Enabled
Power LED in Suspend      : BLINKING
Spread Spectrum           : Disabled

ESC : Quit      F10 : Select Item
F1  : Help      PU/PD/+/- : Modify
F5  : Old Values (Shift) F2 : Color
F6  : Load BIOS Defaults
F7  : Load Performance Defaults
```

**The above settings have to modify according to different kinds of CPU, SDRAM, and peripherals for your system to work properly.

These data are just referred by users, and there is no responsibility for different testing data values gotten by users. (The different Hardware & Software configuration will result in different benchmark testing results.)

- CPU Pentium® III 500MHz processor
- DRAM (128x1)MB SDRAM (Winbond 902WB W986408BH-8H)
- CACHE SIZE 512 KB included in CPU
- DISPLAY Onboard Intel Corporation 810 Graphics Controller Hub (4MB SDRAM)
- STORAGE Onboard IDE (IBM DTTA-371800)
- O.S. Windows NT™4.0 SPK5
- DRIVER Display Driver at 1024 x 768 65536 colors 75Hz.
VIA Bus Master IDE Driver Ver2.3.15

Processor	Intel Pentium® III 500MHz(100x5)
Winbench99	
CPU mark99	37.5
FPU Winmark 99	2560
Business Disk Winmark 99	4140
Hi-End Disk Winmark 99	9200
Business Graphics Winmark 99	196
Hi-End Graphics Winmark 99	370
Winstone99	
Business Winstone99	32.1
Hi-End Winstone99	27.9