

FCC Compliance Statement:

<p style="text-align: center;">DECLARATION OF CONFORMITY <small>Per FCC Part 2 Section 2.107(f)</small></p> <p style="text-align: center;">FC</p> <p>Responsible Party Name: G.B.T. INC.</p> <p style="text-align: center;">Address: 1806 Valley Blvd., Suite#A LA Puente, CA 91744</p> <p style="text-align: center;">Phone/Fax No: (818) 854-9338 / (818) 854-9339</p> <p>hereby declares that the product</p> <p style="text-align: center;">Product Name: Mother Board</p> <p style="text-align: center;">Model Number: GA-7EXR</p> <p>Conforms to the following specifications:</p> <p style="text-align: center;">FCC Part 15, Subpart B, Section 15.107(a) and Section 15.109(a). Class B Digital Device.</p> <p>Supplementary Information:</p> <p style="text-align: center;"><small>This device complies with part 15 of the FCC Rules. Operation is subject to the following two conditions: (1) This device may not cause harmful and (2) this device must accept any interference received, including that may cause undesired operation.</small></p> <p>Representative Person's Name: <u>ERIC LI</u></p> <p>Signature: <u>Eric Li</u></p> <p>Date: <u>Mar 23, 2001</u></p>

This equipment has been tested and found to comply with limits for a Class B digital device, pursuant to Part 15 of the FCC rules. These limits are designed to provide reasonable protection against harmful interference in residential installations. This equipment generates, uses, and can radiate radio frequency energy, and if not installed and used in accordance with the instructions, may cause harmful interference to radio communications. However, there is no guarantee that interference will not occur in a particular installation. If this equipment does cause interference to radio or television equipment reception, which can be

determined by turning the equipment off and on, the user is encouraged to try to correct the interference by one or more of the following measures:

- Reorient or relocate the receiving antenna
- Move the equipment away from the receiver
- Plug the equipment into an outlet on a circuit different from that to which the receiver is connected
- Consult the dealer or an experienced radio/television technician for additional suggestions

You are cautioned that any change or modifications to the equipment not expressly approve by the party responsible for compliance could void Your authority to operate such equipment.

This device complies with Part 15 of the FCC Rules. Operation is subjected to the following two conditions 1) this device may not cause harmful interference and 2) this device must accept any interference received, including interference that may cause undesired operation.

Declaration of Conformity

We, Manufacturer/Importer
(full address)

G.B.T. Technology Trading GmbH
Ausschlagler Weg 41, 1F, 20537 Hamburg, Germany

declare that the product
(description of the apparatus, system, installation to which it refers)

Mother Board
GA-7DXR

is in conformity with
(reference to the specification under which conformity is declared)
in accordance with 89/336 EEC-EMC Directive

- | | | | |
|---------------------------------------------------------------------------------------------------------------|------------------------------------------------------------------------------------------------------------------------------------------------------------|----------------------------------------------------------------------------------------------------|--------------------------------------------------------------------------------------------------------------------------------------------------------|
| <input type="checkbox"/> EN 55011 | Limits and methods of measurement of radio disturbance characteristics of industrial, scientific and medical (ISM) high frequency equipment | <input checked="" type="checkbox"/> EN 61000-3-2*
<input checked="" type="checkbox"/> EN60555-2 | Disturbances in supply systems caused by household appliances and similar electrical equipment "Harmonics" |
| <input type="checkbox"/> EN55013 | Limits and methods of measurement of radio disturbance characteristics of broadcast receivers and associated equipment | <input type="checkbox"/> EN61000-3-3*
<input checked="" type="checkbox"/> EN60555-3 | Disturbances in supply systems caused by household appliances and similar electrical equipment "Voltage fluctuations" |
| <input type="checkbox"/> EN 55014 | Limits and methods of measurement of radio disturbance characteristics of household electrical appliances, portable tools and similar electrical apparatus | <input checked="" type="checkbox"/> EN 50081-1
<input checked="" type="checkbox"/> EN 50082-1 | Generic emission standard Part 1: Residual, commercial and light industry
Generic immunity standard Part 1: Residual, commercial and light industry |
| <input type="checkbox"/> EN 55015 | Limits and methods of measurement of radio disturbance characteristics of fluorescent lamps and luminaries | <input type="checkbox"/> EN 55081-2 | Generic emission standard Part 2: Industrial environment |
| <input type="checkbox"/> EN 55020 | Immunity from radio interference of broadcast receivers and associated equipment | <input type="checkbox"/> EN 55082-2 | Generic immunity standard Part 2: Industrial environment |
| <input checked="" type="checkbox"/> EN 55022 | Limits and methods of measurement of radio disturbance characteristics of information technology equipment | <input type="checkbox"/> ENV 55104 | Immunity requirements for household appliances tools and similar apparatus |
| <input type="checkbox"/> DIN VDE 0855
<input type="checkbox"/> part 10
<input type="checkbox"/> part 12 | Cabled distribution systems; Equipment for receiving and/or distribution from sound and television signals | <input type="checkbox"/> EN 50091- 2 | EMC requirements for uninterruptible power systems (UPS) |

CE marking



(EC conformity marking)

The manufacturer also declares the conformity of above mentioned product with the actual required safety standards in accordance with LVD 73/23 EEC

- | | | | |
|-----------------------------------|---------------------------------------------------------------------------------------------------------------|-------------------------------------|-------------------------------------------------------------------------------------|
| <input type="checkbox"/> EN 60065 | Safety requirements for mains operated electronic and related apparatus for household and similar general use | <input type="checkbox"/> EN 60950 | Safety for information technology equipment including electrical business equipment |
| <input type="checkbox"/> EN 60335 | Safety of household and similar electrical appliances | <input type="checkbox"/> EN 50091-1 | General and Safety requirements for uninterruptible power systems (UPS) |

Manufacturer/Importer

Signature : Rex Lin

Name : Rex Lin

(Stamp)

Date : Mar. 23, 2001

7DXR

AMD Athlon™/Duron™ Socket A Processor
Motherboard

USER'S MANUAL

AMD Athlon™/Duron™ Socket A Processor Motherboard
REV 0.2 First Edition
R-02-01-010330

How This Manual Is Organized

This manual is divided into the following sections:

1) Revision List	Manual revision information
2) Item Checklist	Product item list
3) Features	Product information & specification
4) Installation Guide	Instructions on CPU & Memory Installation
5) Performance & Block Diagram	Product performance & block diagram
6) Suspend to RAM & Dual BIOS	Instructions on STR & Dual BIOS installation
7) Four Speaker & SPDIF	Four Speaker & SPDIF introduction
8) @BIOS™ & EasyTuneIII™	@BIOS™ & EasyTuneIII™ introduction
9) Raid	Instructions on Raid
10) BIOS Setup	Instructions on setting up the BIOS software
11) Technical Support/RMA Sheet	Document equipment used for after sales service
12) Appendix	General reference

Table Of Content

Revision History	P.1
Item Checklist	P.2
Feature Summary	P.3
7DXR Motherboard Layout	P.5
Installation Guide	P. 6
Page Index for Connectors / Panel and Jumper Definition	P.15
Performance List	P.38
Block Diagram	P.39
Suspend to RAM Installation	P.40
Dual BIOS Introduction	P.46
Four Speaker & SPDIF Introduction	P.53
@BIOS™ Introduction	P.59
EasyTuneIII™ Introduction	P.60
Raid Introduction	P.62
Page Index for BIOS Setup	P.85
Technical Support / RMA Sheet	P.119
Appendix	P.120

Revision History

Revision	Revision Note	Date
0.2	Initial release of the 7DXR motherboard user's manual.	Mar. 2001

The author assumes no responsibility for any errors or omissions that may appear in this document nor does the author make a commitment to update the information contained herein. Third-party brands and names are the property of their respective owners.

Item Checklist

- The 7DXR Motherboard
- Cable for IDE / Floppy device
- CD (TUCD) for motherboard utilities
- 7DXR User's Manual
- Front USB Cable

Features Summary

Form Factor	<ul style="list-style-type: none"> • 30.5 cm x 24.5 cm ATX size form factor, 4 layers PCB.
CPU	<ul style="list-style-type: none"> • AMD Athlon™/Duron™ (K7) Socket A Processor • 256K/64K L2 cache on die • Supports 600MHz ~ 1GHz and above
Chipset	<p>7DXR, consisting of:</p> <ul style="list-style-type: none"> • AMD 761 Memory/PCI/AGP Controller • VT82C686B PCI Super-I/O Integrated Peripheral Controller (PSIPC)
Clock Generator	<ul style="list-style-type: none"> • ICS 94240 • 200/266 MHz DDR bus speeds • 95/100/106/114/120/133/140/150 MHz system bus speeds by CLK_SW DIP switch • Supports adjustable CPU frequency from 100MHz to 250MHz by 1MHz step in BIOS setup
Memory	<ul style="list-style-type: none"> • 3 184-pin DDR DIMM sockets • Supports PC1600 DDR or PC2100 DDR SDRAM • Supports up to 3GB DRAM (Max) • Supports only 2.5V DDR SDRAM • Supports 72bit ECC type DRAM integrity mode
I/O Control	<ul style="list-style-type: none"> • VT82C686B
Slots	<ul style="list-style-type: none"> • 1 Universal AGP Pro slot 4X/2X (1.5V/3.3V) device support • 5 PCI slots supports 33MHz & PCI 2.2 compliant • 1 AMR (Audio Modem Riser) slot
On-Board IDE	<ul style="list-style-type: none"> • IDE 1 and IDE 2 Supports PIO mode 3, 4 UDMA 33 / ATA 66 / ATA100 IDE & ATAPI CD-ROM • IDE 3 and IDE 4 Compatible with Raid, Ultra ATA100, Ultra ATA66, Ultra ATA33, EIDE • 4 IDE bus master IDE ports for up to 8 ATAPI devices
On-Board Peripherals	<ul style="list-style-type: none"> • 1 floppy port supports 2 FDD with 360K, 720K, 1.2M, 1.44M and 2.88M bytes • 1 parallel ports supports Normal/EPP/ECP mode • 2 serial ports (COM A & COM B) • 4 USB ports • 1 IrDA connector for IR

To be continued...

Hardware Monitor	<ul style="list-style-type: none"> • CPU/System fan revolution detect • CPU/System temperature detect • System voltage detect • CPU overheat warning detect
On-Board Sound	<ul style="list-style-type: none"> • Creative CT5880 sound • Line In/Line Out/Mic In/AUX In (Optional)/CD In/TEL (Optional)/Game Port/ Four Speaker & SPDIF
PS/2 Connector	<ul style="list-style-type: none"> • PS/2[®] Keyboard interface and PS/2[®] Mouse interface
BIOS	<ul style="list-style-type: none"> • Licensed AWARD BIOS, 2M bit flash ROM • Support Dual BIOS
Additional Features	<ul style="list-style-type: none"> • Support Wake-On-LAN (WOL) • Support Internal / External Modem Ring On • Support USB KB/MS Wake up from S3 • Includes 5 fan power connectors • Poly fuse for keyboard over-current protection • Support STR (Suspend-To-RAM) function • Support @BIOS[™] and EasyTuneIII[™]

7DXR Motherboard Layout

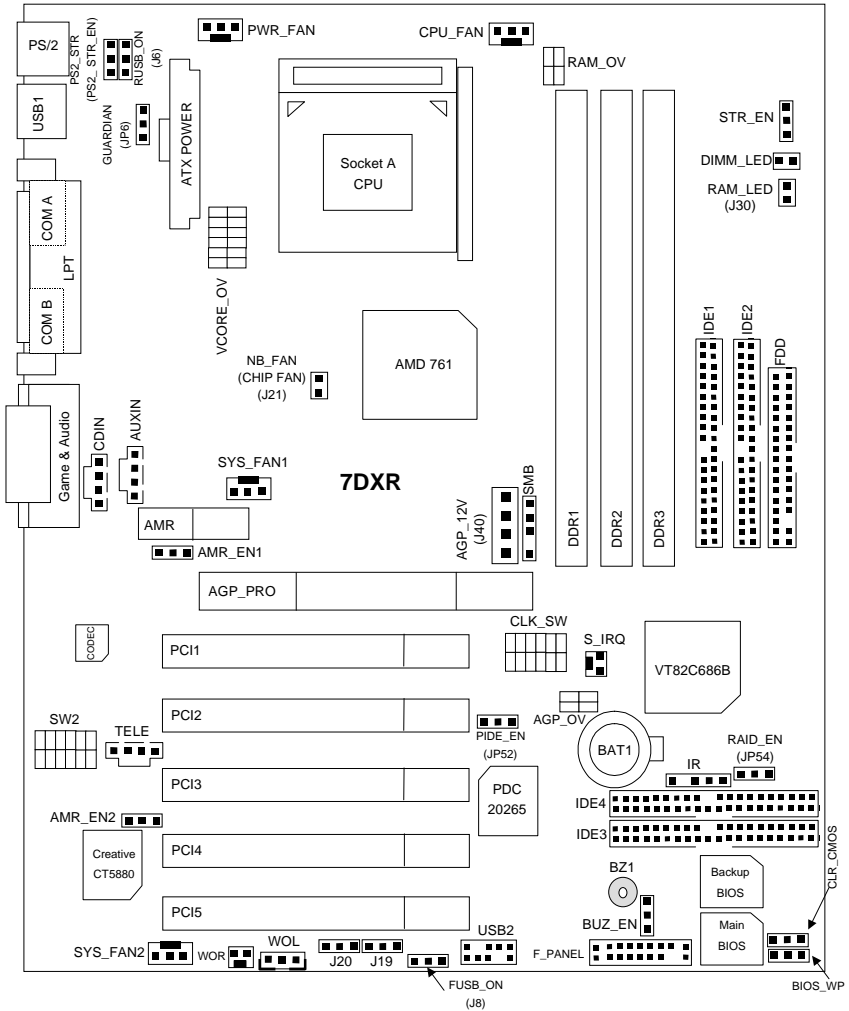

Installation Guide

Getting Started



WARNING!

Computer motherboards and expansion cards contain very delicate Integrated Circuit (IC) chips. To protect them against damage from static electricity, you should follow some precautions whenever you work on your computer.

1. Unplug your computer when working on the inside.
2. Use a grounded wrist strap before handling computer components. If you do not have one, touch both of your hands to a safely grounded object or to a metal object, such as the power supply case.
3. Hold components by the edges and try not touch the IC chips, leads or connectors, or other components.
4. Place components on a grounded antistatic pad or on the bag that came with the components whenever the components are separated from the system.
5. Ensure that the ATX power supply is switched off before you plug in or remove the ATX power connector on the motherboard.

Installing the motherboard to the chassis...

If the motherboard has mounting holes, but they don't line up with the holes on the base and there are no slots to attach the spacers, do not become alarmed you can still attach the spacers to the mounting holes. Just cut the bottom portion of the spacers (the spacer may be a little hard to cut off, so be careful of your hands). In this way you can still attach the motherboard to the base without worrying about short circuits. Sometimes you may need to use the plastic springs to isolate the screw from the motherboard PCB surface, because the circuit wire may be near by the hole. Be careful, don't let the screw contact any printed circuit write or parts on the PCB that are near the fixing hole, otherwise it may damage the board or cause board malfunctioning.

7DXR Motherboard

To set up your computer, you must complete the following steps:

- ▶ Step 1 - Set system jumpers
- ▶ Step 2- Install the Central Processing Unit (CPU)
- ▶ Step 3-Install memory modules
- ▶ Step 4-Install expansion cards
- ▶ Step 5-Connect ribbon cables, cabinet wires, and power supply
- ▶ Step 6-Set up BIOS software
- ▶ Step 7-Install supporting software tools

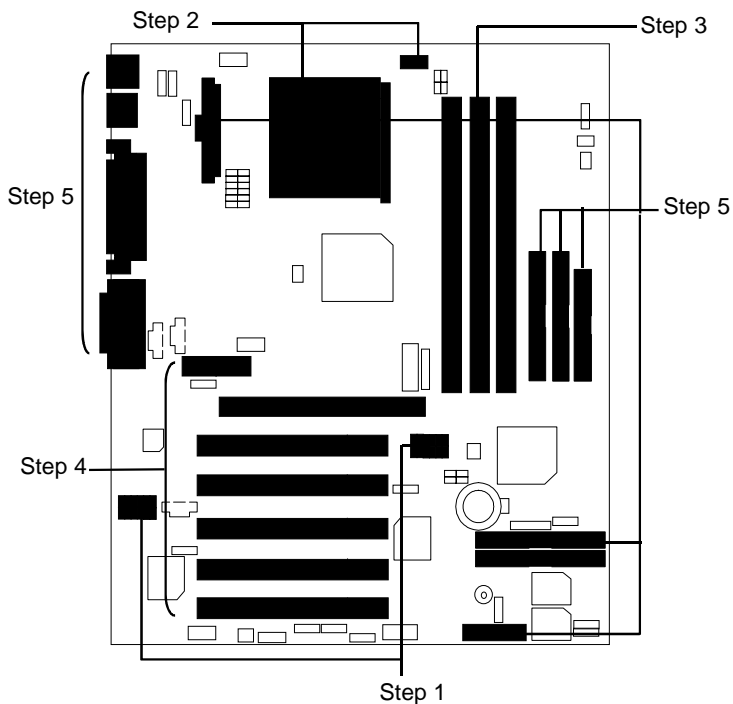

CPU Speed Setup

The system bus speed is selectable at 95-150MHz. The user can select the system bus speed by DIP switch **CLK_SW** or **J19 & J20** (For 100MHz or 133MHz). (The frequency ratio depend on CPU)

CLK_SW Select the System Speed: O: ON, X: OFF

FREQ.			SW1	SW2	SW3	SW4	SW5	SW6
CPU	PCI	AGP	FS0	FS1	FS2	FS3	FS4	100-133
95	31.67	63.33	X	O	O	O	O	X
100.99 (Default)	33.66	67.33	O	X	O	O	O	X
106	35.33	70.67	O	X	O	X	O	X
114	38	76	O	X	O	O	X	X
120	30	60	X	X	X	O	X	X
133	33	66	O	O	O	O	O	O
140	35	70	O	X	X	X	X	O
150	37.5	75	X	X	X	X	X	O

***Please depend on your CPU frequency to setup.**

J19 & J20: CLK Speed (Optional)

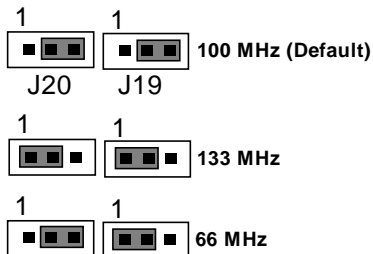
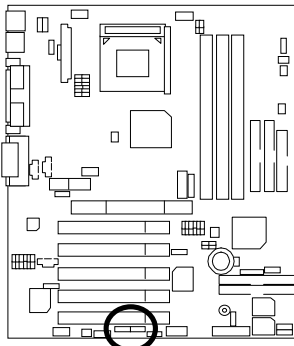

J19	J20	CLK Speed
2-3 close	2-3 close	100MHz(Default)
1-2 close	1-2 close	133MHz
1-2 close	2-3 close	66MHz

7DXR Motherboard

SW2 Select the CPU frequency Override:

O: ON, X: OFF

Ratio	1	2	3	4	5
Auto (Default)	X	X	X	X	O
5X	O	O	X	O	X
5.5X	X	O	X	O	X
6X	O	X	X	O	X
6.5X	X	X	X	O	X
7X	O	O	O	X	X
7.5X	X	O	O	X	X
8X	O	X	O	X	X
8.5X	X	X	O	X	X
9X	O	O	X	X	X
9.5X	X	O	X	X	X
10X	O	X	X	X	X
10.5X	X	X	X	X	X
11X	O	O	O	O	X
11.5X	X	O	O	O	X
12X	O	X	O	O	X
12.5X	X	X	O	O	X

*This function will not be available if you are using a CPU with locked ratio.

CPU Installation

Please make sure the CPU should be supported to the motherboard.

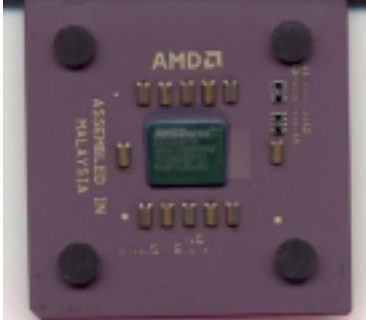

CPU Top View

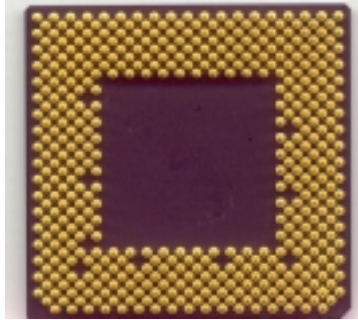

CPU Bottom View

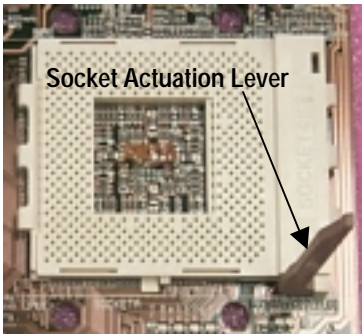

1. Pull the lever out and lift it up.

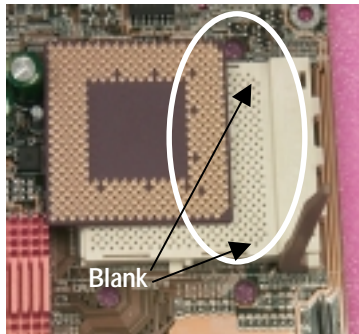

2. The notched corner should be orientated toward the blank space on the socket nearest the lever. The CPU will only fit in the orientation as shown.

CPU Heat Sink Installation:

Beware: Please check that the heat sink is in good contact with the CPU before you turn on your system. **The poor contact will cause over heat, and might cause damage to your processor!**

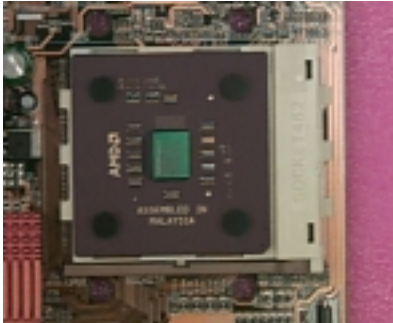

3. Align CPU and insert it
(Please refer to your heatsink installation manual for application of thermal grease to provide better heat conduction between your CPU and heatsink.)



4. Use compliant fan approved by AMD.

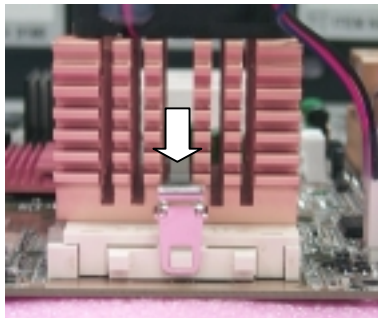
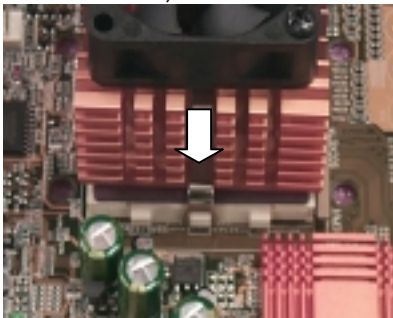

5. Hook one end of the cooler bracket to the CPU socket.

6. Hook the other end of the cooler bracket to the CPU socket.

 (Please refer to the cooler's installation manual for detailed installation steps)

Memory Installation

The motherboard has 3 dual inline memory module (DIMM) sockets. The BIOS will automatically detects memory type and size. To install the memory module, just push it vertically into the DIMM Slot .The DIMM module can only fit in one direction due to the notch. Memory size can vary between sockets.

Total Memory Sizes With Registered DDR DIMM

Devices used on DIMM	1 DIMM x64/x72	2 DIMMs x64/x72	3 DIMMs x64/x72
64 Mbit (4Mx4x4 banks)	256 MBytes	512 MBytes	768 MBytes
64 Mbit (2Mx8x4 banks)	128 MBytes	256 MBytes	384 MBytes
64 Mbit (1Mx16x4 banks)	64 MBytes	128 MBytes	192 MBytes
128 Mbit (8Mx4x4 banks)	512 MBytes	1 GBytes	1.5 GBytes
128 Mbit (4Mx8x4 banks)	256 MBytes	512 MBytes	768 MBytes
128 Mbit (2Mx16x4 banks)	128 MBytes	256 MBytes	384 MBytes
256 Mbit (16Mx4x4 banks)	1 GBytes	2 GBytes	3 GBytes
256 Mbit (8Mx8x4 banks)	512 MBytes	1 GBytes	1.5 GBytes
256 Mbit (4Mx16x4 banks)	256 MBytes	512 MBytes	768 MBytes
512 Mbit (16Mx8x4 banks)	1 GBytes	2 GBytes	3 GBytes
512 Mbit (8Mx16x4 banks)	512 MBytes	1 GBytes	1.5 GBytes

7DXR Motherboard

Total Memory Sizes With Unbuffered DDR DIMM

Devices used on DIMM	1 DIMM x64/x72	2 DIMMs x64/x72	3 DIMMs x64/x72
64 Mbit (2Mx8x4 banks)	128 MBytes	256 MBytes	384 MBytes
64 Mbit (1Mx16x4 banks)	64 MBytes	128 MBytes	192 MBytes
128 Mbit (4Mx8x4 banks)	256 MBytes	512 MBytes	768 MBytes
128 Mbit (2Mx16x4 banks)	128 MBytes	256 MBytes	384 MBytes
256 Mbit (8Mx8x4 banks)	512 MBytes	1 GBytes	1.5 GBytes
256 Mbit (4Mx16x4 banks)	256 MBytes	512 MBytes	768 MBytes
512 Mbit (16Mx8x4 banks)	1 GBytes	2 GBytes	3 GBytes
512 Mbit (8Mx16x4 banks)	512 MBytes	1 GBytes	1.5 GBytes

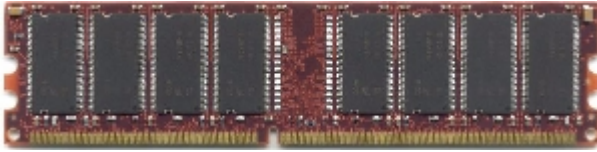

DDR

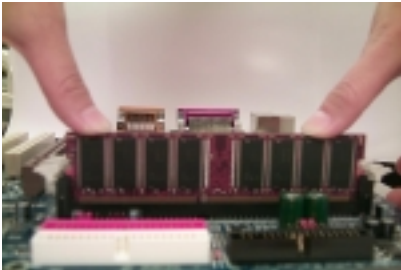

1. The DIMM slot has a notch, so the DIMM memory module can only fit in one direction.
 2. Insert the DIMM memory module vertically into the DIMM slot. Then push it down.
 3. Close the plastic clip at both edges of the DIMM slots to lock the DIMM module.
-  Reverse the installation steps when you wish to remove the DIMM module.

DDR Introduction

Established on the existing SDRAM industry infrastructure, DDR (Double Data Rate) memory is a high performance and cost-effective solution that allows easy adoption for memory vendors, OEMs and system integrators.

DDR memory is a sensible evolutionary solution for the PC industry that builds on the existing SDRAM infrastructure, yet makes awesome advances in solving the system performance bottleneck by doubling the memory bandwidth. DDR SDRAM will offer a superior solution and migration path from existing SDRAM designs due to its availability, pricing and overall market support. PC2100 DDR memory (DDR266) doubles the data rate through reading and writing at both the rising and falling edge of the clock, achieving data bandwidth 2X greater than PC133 when running with the same DRAM clock frequency. With peak bandwidth of 2.1GB per second, DDR memory enables system OEMs to build high performance and low latency DRAM subsystems that are suitable for servers, workstations, high-end PC's and value desktop SMA systems. With a core voltage of only 2.5 Volts compared to conventional SDRAM's 3.3 volts, DDR memory is a compelling solution for small form factor desktops and notebook applications.

7DXR Motherboard

Page Index for Connectors/Panel and Jumper Definition	Page
Connectors	P.17
ATX Power	P.17
AUXIN (AUX_IN) [Optional]	P.22
AGP_OV (AGP 4X Overvoltage Switch)	P.28
AGP_12V (J40) (Power for AGP Pro)	P.27
COM A / COM B / LPT Port	P.17
CDIN (CD Audio Line In)	P.21
CPU_FAN (CPU Fan)	P.25
Floppy Port	P.19
Game & Audio Port	P.20
IDE 1 (Primary) / IDE 2 (Secondary) Port	P.20
IDE 3 / IDE 4 (Raid / ATA100) Port	P.21
IR (IR Header)	P.27
NB_FAN (J21) (CHIP FAN)	P.28
PWR_FAN (Power Fan)	P.24
PS/2 Keyboard & PS/2 Mouse Connector	P.18
RAM_OV (RAM Overvoltage)	P.30
RAM_LED (J30) / DIMM LED (DIMM LED Connector & DIMM LED) [RAM_LED (J30) is optional]	P.26
SYS_FAN 1 (System Fan 1)	P.24
SYS_FAN 2 (System Fan 2)	P.25
SMB (External SMBUS Device Connector) [Optional]	P.23
TELE (TEL) [Optional]	P.22
USB1 (Rear USB Connector)	P.18
USB2 (Front USB Connector)	P.19
VCORE_OV (CPU Core Overvoltage Switch) [Optional]	P.29
WOR (Ring Power On)	P.23
WOL (Wake On Lan)	P.26
Panel and Jumper Definition	P.31
AMR_EN1 & AMR_EN2 (AMR Selection) [Optional]	P.35
BAT 1(Battery)	P.36
BIOS_WP (BIOS Write Protect Function) [Optional]	P.33
BUZ_EN (Internal Buzzer Connector) [Optional]	P.32
CLR_CMOS (Clear CMOS Function)	P.32
F_PANEL (2x11 pins jumper)	P.31

FUSB_ON (J8) (Front USB Device Wake Up Selection)	P.34
GUARDIAN (JP6) (Guardian)	P.34
PIDE_EN (JP52) (Onboard Promise selection)	P.35
PS2_STR (PS2_STR_EN) (PS/2 KB/MS STR Enable Selection)	P.37
RAID_EN (JP54) (Raid / ATA100 Selection)	P.36
RUSB_ON (J6) (Rear USB Device Wake up Selection)	P.33
STR_EN (STR Selection)	P.37

Connectors

ATX Power

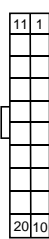
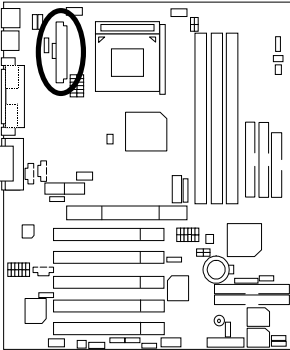

Pin No.	Definition
3,5,7,13,15-17	GND
1,2,11	3.3V
4,6,19,20	VCC
10	+12V
12	-12V
18	-5V
8	Power Good
9	5V SB (stand by+5V)
14	PS-ON(Soft On/Off)



Please note:
AC power cord should only be inserted to your power supply unit after ATX power cable and other related devices are firmly connected to the mainboard.

COM A / COM B / LPT Port

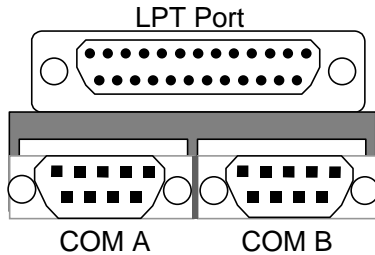
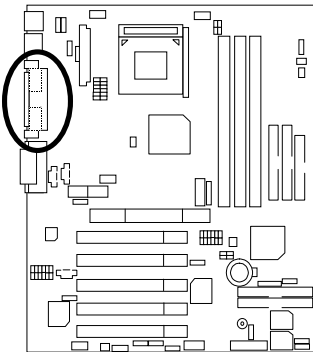

Please note:
This mainboard supports 2 standard COM ports and 1 LPT port. Device like printer can be connected to LPT port ; mouse and modem etc can be connected to COM ports.

PS/2 Keyboard & PS/2 Mouse Connector

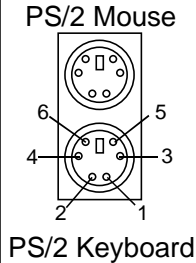
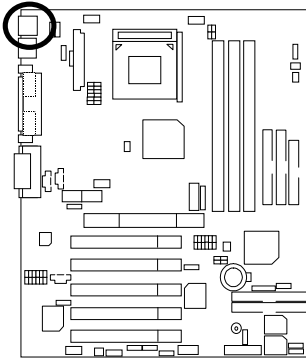

PS/2 Mouse/ Keyboard	
Pin No.	Definition
1	Data
2	NC
3	GND
4	POWER
5	Clock
6	NC



Please note:

This mainboard supports standard PS/2 keyboard and PS/2 mouse interface connector.

USB1: USB Connector

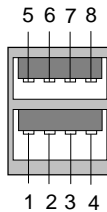
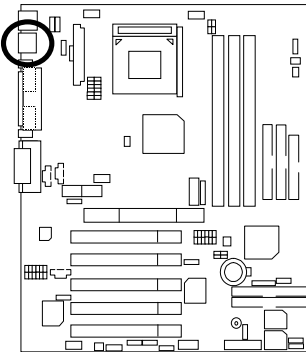

Pin No.	Definition
1	USB Power
2	USB D0-
3	USB D0+
4	GND
5	USB Power
6	USB D1-
7	USB D1+
8	GND



Please note:

Before you connect your device(s) into USB connector(s), please make sure your device(s) has a standard USB interface like, USB keyboard, mouse, scanner, zip, speaker... Also make sure your OS supports USB controller (Win 95 w/ USB supperment, Win98, Windows 2000, Windows ME, Win NT w/ SP 6). If your OS does not support USB controller, please contact OS vander for passible patch or driver upgrade. For more information please contact your OS or device(s) vanders.

USB2: Front USB Connector

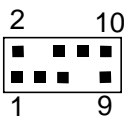
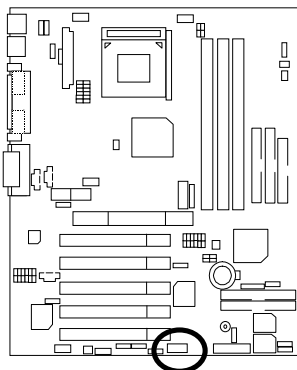

Pin No.	Definition
1	POWER
2	GND
3	USB D2-
4	NC
5	USB D2+
6	USB D3+
7	NC
8	USB D3-
9	GND
10	POWER



Please note:

Be careful with the polarity of the front panel USB connector. Check the pin assignment while you connect the front panel USB cable. Please contact your nearest dealer for optional front panel USB cable.

Floppy Port

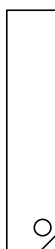
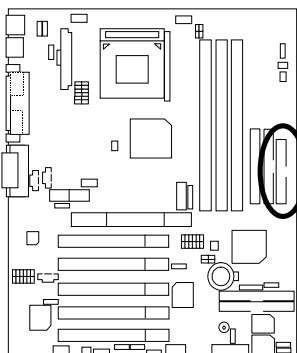

RED LINE

Game & Audio Port

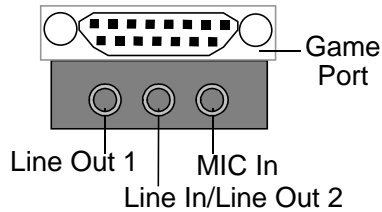
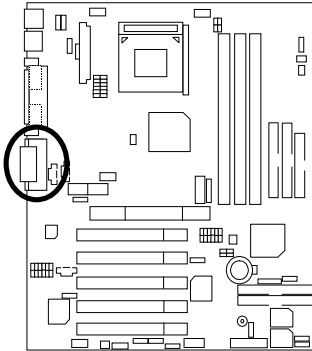

Please note:

Line Out 1: Line Out or SPDIF (The SPDIF output is capable of providing digital audio to external speakers or compressed AC3 data to an external Dolby digital decoder). To enable SPDIF, simply insert SPDIF connector into Line Out1. Line Out1 will become SPDIF Out automatically. (see page 56 for more information). To enable Four Speaker (for Creative 5880 audio only), simply follow instructions on page 53 and Line In will become Line Out2 to support second pair of stereo speakers.

IDE1 (Primary), IDE2 (Secondary) Port

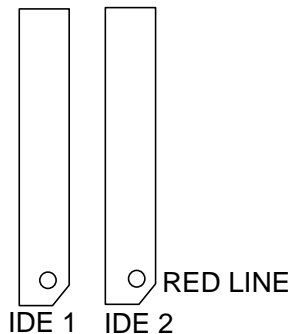
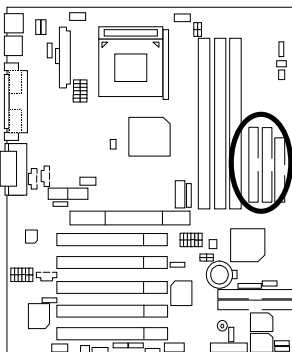

IDE3/IDE4 (Raid/ATA100) Port

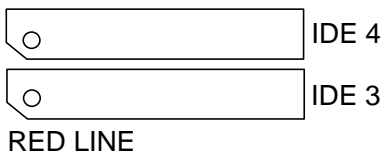
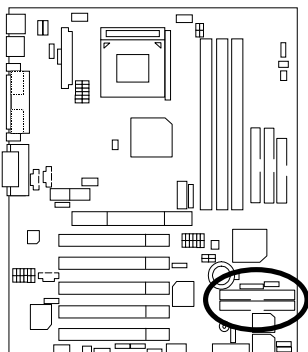

CDIN: CD Audio Line In

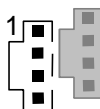
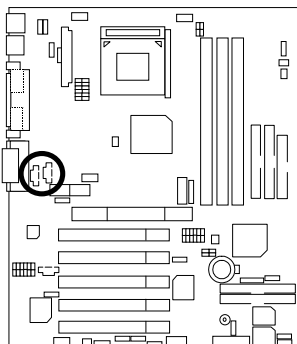

Pin No.	Definition
1	CD-L
2	GND
3	GND
4	CD-R

AUXIN: AUX_IN (Optional)

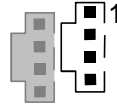
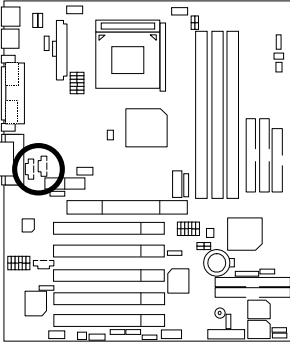

Pin No.	Definition
1	AUX-L
2	GND
3	GND
4	AUX-R

TELE: TEL (The connector is for internal modem card with voice connector) [Optional]

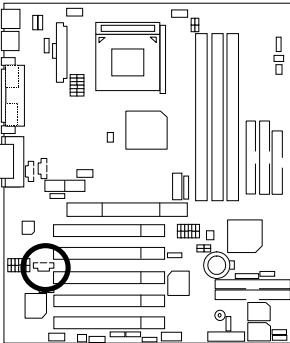

Pin No.	Definition
1	Signal-In
2	GND
3	GND
4	Signal-Out

WOR: Ring Power On

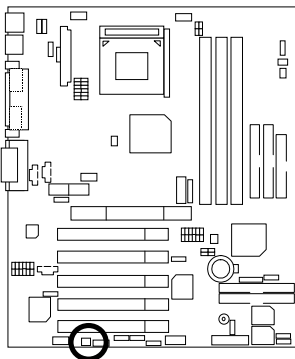

Pin No.	Definition
1	Signal
2	GND

SMB: External SMBUS Device Connector (Optional)

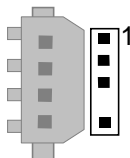
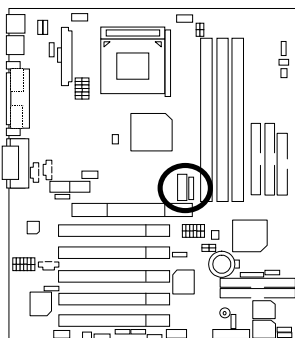

Pin No.	Definition
1	SMB CLK
2	NC
3	GND
4	SMB DATA
5	+5V

SYS_FAN1: System Fan 1

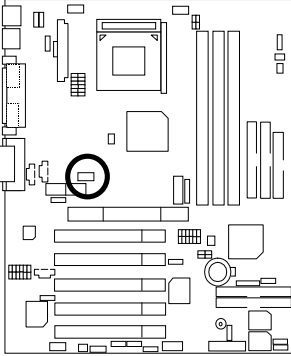

Pin No.	Definition
1	Control
2	+12V
3	SENSE

PWR_FAN: Power Fan

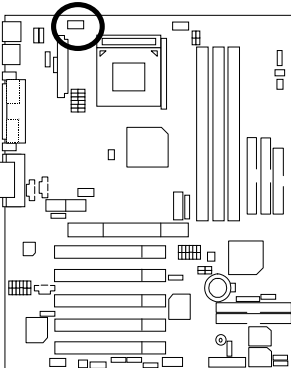

Pin No.	Definition
1	Control
2	+12V
3	SENSE

CPU_FAN: CPU Fan

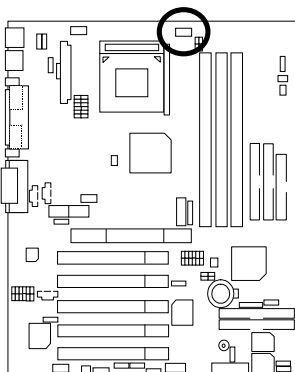

Pin No.	Definition
1	Control
2	+12V
3	SENSE



Please note:

A proper installation of the CPU cooler is essential to prevent the CPU from running under abnormal condition or damaged by overheating. With support CPU guardian function CPU cooler must connect with this connector, otherwise system could not boot.

SYS_FAN2: System Fan 2

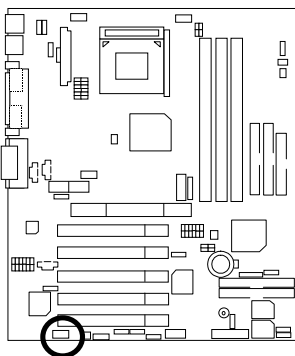

Pin No.	Definition
1	Control
2	+12V
3	SENSE

WOL: Wake on LAN

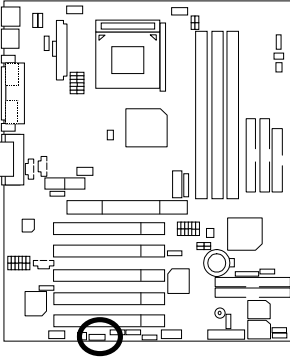

Pin No.	Definition
1	+5V SB
2	GND
3	Signal

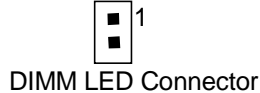
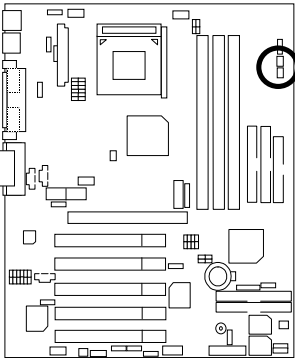
RAM_LED (J30) / DIMM_LED: DIMM LED Connector & DIMM LED
(RAM_LED (J30) is optional)**Please note:**

Do not remove memory modules while DIMM LED is on. It might cause short or other unexpected damages due to the 2.5V stand by voltage. Remove memory modules only when STR function is disabled by jumper and AC Power cord is disconnected.

IR: IR Header

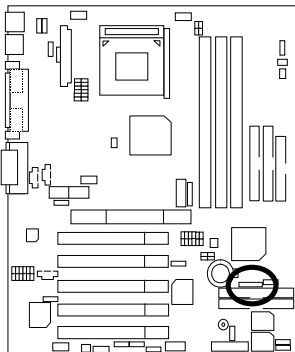

Pin No.	Definition
1	VCC (+5V)
2	NC
3	IR Data Input
4	GND
5	IR Data Output



Please note:

Be careful with the polarity of the IR connector while you connect the IR. Please contact you nearest dealer for optional IR device.

AGP_12V (J40): Power for AGP Pro

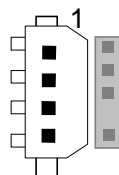
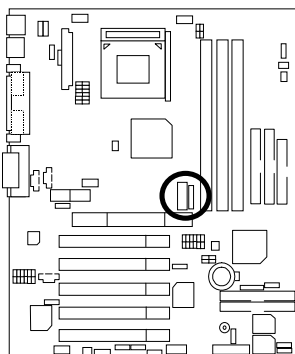

Pin No.	Definition
1	+5V
2	GND
3	GND
4	+12V



Please note:

When using the AGP Pro Card, you must use the power connector (As the other one for HDD). Otherwise, AGP Pro Card will not work.

NB_FAN (J21): CHIP FAN

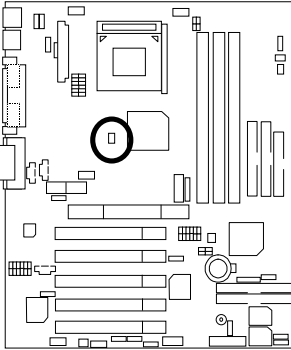

Pin No.	Definition
1	GND
2	+12V

**Please note:**

If installed wrong direction, the Chip Fan will not work. Sometimes will damage the Chip Fan. (Usually black cable is GND)

AGP_OV: AGP 4X Overvoltage Switch

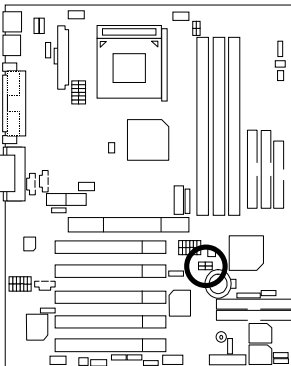

	SW1	SW2
1.5V (Default)	OFF	OFF
1.6V	ON	OFF
1.7V	OFF	ON

**Please note:**

The function provide AGP over voltage, Incorrect using it may cause your AGP card damage. For power End-User use only!

VCORE_OV: CPU Core Overvoltage Switch (Optional)

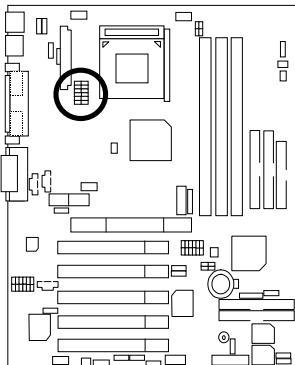

ON

O:ON, X:OFF

	1	2	3	4	5	6
Auto	X	X	X	X	X	O
1.5V	O	X	X	X	O	X
1.525V	X	O	X	X	O	X
1.55V	O	O	X	X	O	X
1.575V	X	X	O	X	O	X
1.6V	O	X	O	X	O	X
1.625V	X	O	O	X	O	X
1.65V	O	O	O	X	O	X
1.675V	X	X	X	O	O	X
1.7V	O	X	X	O	O	X
1.725V	X	O	X	O	O	X
1.75V	O	O	X	O	O	X
1.755V	X	X	O	O	O	X
1.8V	O	X	O	O	O	X
1.825V	X	O	O	O	O	X
1.85V	O	O	O	O	O	X

**Please note:**

Provide CPU core voltage override function, Incorrect using it may cause your CPU broken. For power End-User use only!

RAM_OV: RAM Overvoltage

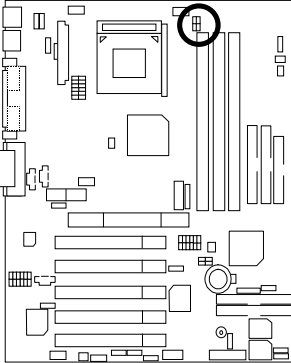

O:ON, X:OFF

	SW1	SW2
2.5V (Default)	OFF	OFF
2.6V	ON	OFF
2.7V	OFF	ON



Please note:
Provide DDR voltage override function. Incorrect using may cause your DDR broken. For power End-User only!

Panel And Jumper Definition

F_PANEL: For 2X11 Pins Jumper

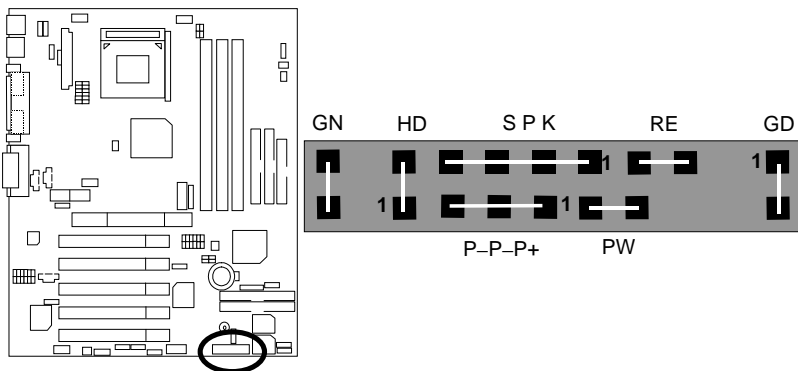

GN (Green Switch)	Open: Normal Operation Close: Entering Green Mode
GD (Green LED)	Pin 1: LED anode(+) Pin 2: LED cathode(-)
HD (IDE Hard Disk Active LED)	Pin 1: LED anode(+) Pin 2: LED cathode(-)
SPK (Speaker Connector)	Pin 1: VCC(+) Pin 2- Pin 3: NC Pin 4: Data(-)
RE (Reset Switch)	Open: Normal Operation Close: Reset Hardware System
P+P-P-(Power LED)	Pin 1: LED anode(+) Pin 2: LED cathode(-) Pin 3: LED cathode(-)
PW (Soft Power Connector)	Open: Normal Operation Close: Power On/Off



Please note:

Please connect the power LED, PC speaker, reset switch and power switch etc of your chassis front panel to the front panel jumper according to the pin assignment

above.

BUZ_EN: Internal Buzzer Connector (Optional)

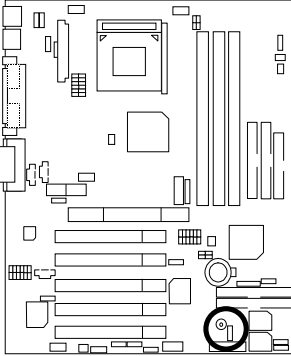

**Enable
(Default)**



Disable

Pin No.	Definition
1-2 close	Internal Buzzer Enable (Default)
2-3 close	Internal Buzzer Disable

CLR_CMOS: Clear CMOS Function

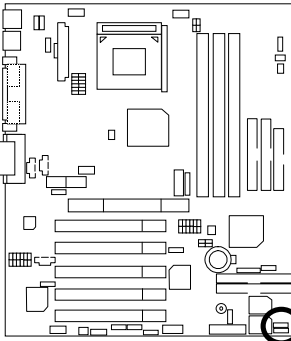

**Disable
(Default)**

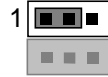

Clear CMOS

Pin No.	Definition
1-2 Close	Enable Clear CMOS Function
2-3 Close	Disable Clear CMOS Function (Default)



Please note:

You may clear the CMOS data to its default values by this jumper.

BIOS_WP: BIOS Write Protect Function (Optional)

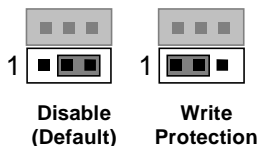
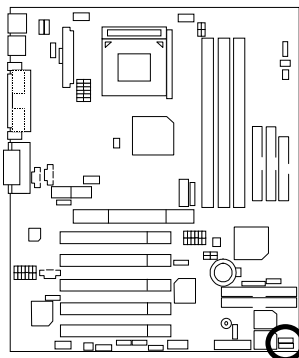

Pin No.	Definition
1-2 close	Write Protect Enable
2-3 close	Write Protect Disable (Default)



Please note:

To flash/upgrade BIOS on this MB BIOS_WP jumper must be opened. We recommend BIOS_WP jumper to be set to "2-3 close", whenever user is not try to flash/upgrade the BIOS.

RUSB_ON (J6): Rear USB Device Wake up Selection

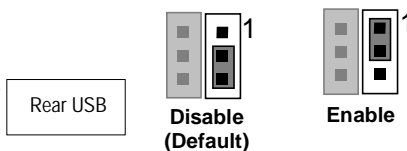
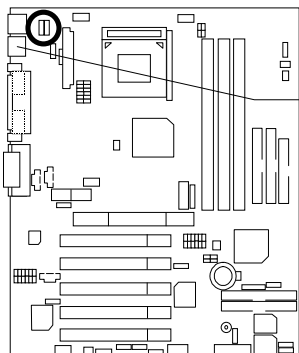

Pin No.	Definition
1-2 close	Rear USB Device Wake up Enable
2-3 close	Rear USB Device Wake up Disable (Default)



Please note:

To use "USB KB/MS Wakeup from S3-S5" function, set BIOS setting "USB KB/MS Wake up from S3-S5" to ENABLED and enable jumpers RUSB_ON (J6) & STR_EN.

*(Power on the computer and as soon as memory counting starts, press . You will enter BIOS Setup. Select the item "POWER MANAGEMENT SETUP", then select "USB KB/MS Wake up from S3-S5". Remember to save the setting by pressing "ESC" and choose the "SAVE & EXIT SETUP" option.)

FUSB_ON (J8): Front USB Device Wake up Selection

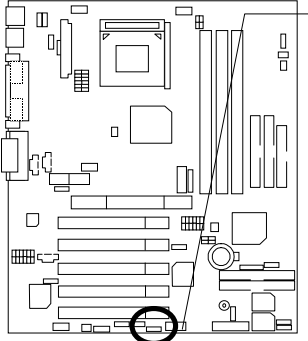

Front USB

1



**Disable
(Default)**

1



Enable

Pin No.	Definition
1-2 close	Front USB Device Wake up Enable
2-3 close	Front USB Device Wake up Disable (Default)



Please note:

To use "USB KB/MS Wakeup from S3-S5" function, set BIOS setting "USB KB/MS Wake up from S3-S5" to ENABLED and enable jumpers FUSB_ON (J8) & STR_EN.

***(Power on the computer and as soon as memory counting starts, press . You will enter BIOS Setup. Select the item "POWER MANAGEMENT SETUP", then select "USB KB/MS Wake up from S3-S5". Remember to save the setting by pressing "ESC" and choose the "SAVE & EXIT SETUP" option.)**

GUARDIAN (JP6): Guardian

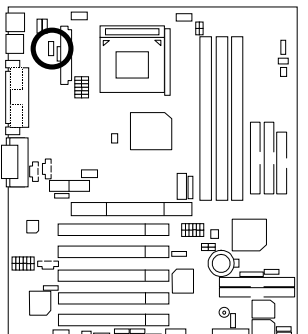

1



**Enable
(Default)**

1



Disable

Pin No.	Definition
1-2 close	Enable Guardian Function (Default)
2-3 close	Disable Guardian Function



Please note:

If CPU guardian function enable you must let CPU cooler connect with CPU_FAN otherwise system could not boot.

AMR_EN1 & AMR_EN2: AMR Selection (Optional)

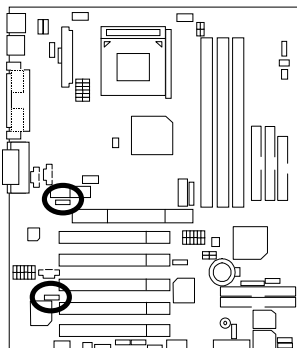

1  AMR_EN1

1  AMR_EN2

AMR_EN1	AMR_EN2	Primary CODEC
1-2 close	1-2 close	AMR Primary AC'97 Disabled (Disabled Onboard CODEC)
2-3 close	2-3 close	AMR Secondary (Default)



Please note:

7DXR: If M/B has hardware audio (CT5880), your modem riser has been set to "Primary" automatically. No Jumpers AMR_EN1 & AMR_EN2 for 7DXR.

7DXR: AMR_EN1 & AMR_EN2: 1-2 close: If you don't use onboard software audio, your audio/modem riser must be "Primary". Mainboard's software audio will be disabled. AMR_EN1 & AMR_EN2: 2-3 close: If you use software audio (onboard CODEC only), your modem riser must be "Secondary".

There are two kind of AMR/MR card in the market, Primary and secondary. If your AMR/MR card is primary, AMR_EN1 & AMR_EN2 should be set to 1-2, if you have secondary AMR/MR card AMR_EN1 & AMR_EN2 should be set to 2-3.

Warning! If Primary AMR/MR card is used, on-board audio will be disabled.

PIDE_EN (JP52): Onboard Promise Selection

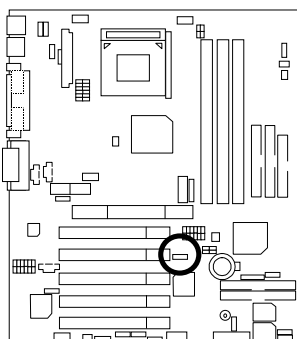

1 

**Enable
(Default)**

1 

Disable

Pin No.	Definition
1-2 close	Enable Promise function (Default)
2-3 close	Disable Promise function

RAID_EN (JP54): Raid/ATA100 Selection

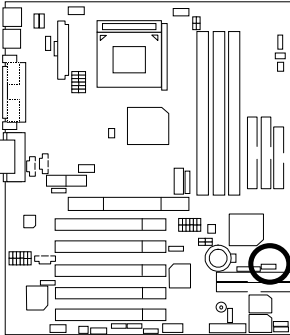

**ATA 100 Mode
(Default)**



Raid Mode

Pin No.	Definition
1-2 close	Raid Mode
2-3 close	ATA100 Mode (Default)





Please note:

If you want to use "Raid Mode", your IDE3 and IDE4 must be connected with Hard Driver. Please set PDIE_EN (JP52) as enable before adjusting RAID_EN (JP54).

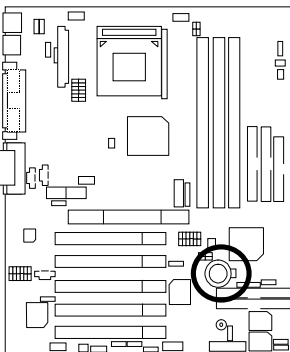
BAT1: Battery



CAUTION

-  Danger of explosion if battery is incorrectly replaced.
-  Replace only with the same or equivalent type recommended by the manufacturer.
-  Dispose of used batteries according to the manufacturer's instructions.

STR_EN: STR Selection

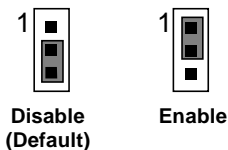
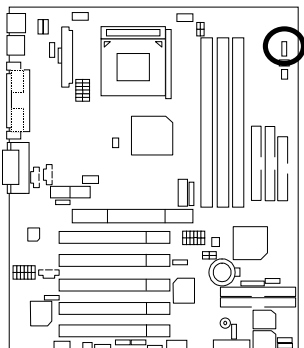

Pin No.	Definition
1-2 close	STR Enable
2-3 close	STR Disable (Default)

PS2_STR (PS2_STR_EN): PS/2 KB/MS STR Enable Selection

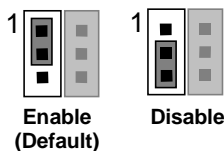
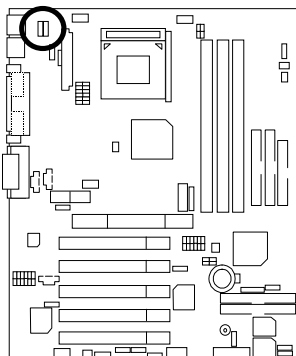

Pin No.	Definition
1-2 close	Enable PS/2 KB/MS STR function (Default)
2-3 close	Disable PS/2 KB/MS STR function



Please note:
Please set SRT_EN as enable before adjusting PS2_STR(PS2_STR_EN).

Performance List

The following performance table lists the results of some popular benchmark testing programs. These data are provided as reference only and in no way guarantee the system shall perform, and there is no responsibility for different testing data at exactly the same level. (The different Hardware & Software configuration will result in different benchmark testing results.)

- CPU AMD K7 Athlon™ 1333MHz processor
- DRAM (128x1) MB PC266 DDR RAM (SAMSUNG K4H280838B-TCB0)
- CACHE SIZE 384 KB included in Athlon™
- DISPLAY GA-GF2000 DDR (32MB)
- STORAGE Onboard Promise RAID0 (IBM DTLA-307045 45GB x 2)
- O.S. Windows 2000 + SP1 + DirectX8
- DRIVER Display Driver at 1024 x 768 x 64k colors x 75Hz.
TUCD ver. 1.7

Processor	AMD Athlon™ 1333MHz (266x5)
Winbench99	
CPU mark 99	122
FPU Winmark 99	7310
Business Disk Winmark 99	11000
Hi-End Disk Winmark 99	25300
Business Graphics Winmark 99	640
Hi-End Graphics Winmark 99	1320
Winstone 2001	
Business Winstone 2001	52.3
Content Creative Winstone 2001	55.5

- If you wish to maximize the performance of your system, please refer to the detail on P.96

Block Diagram

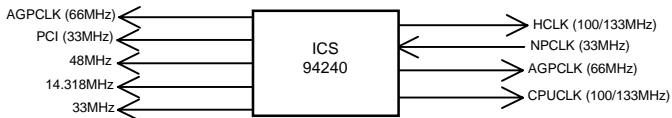
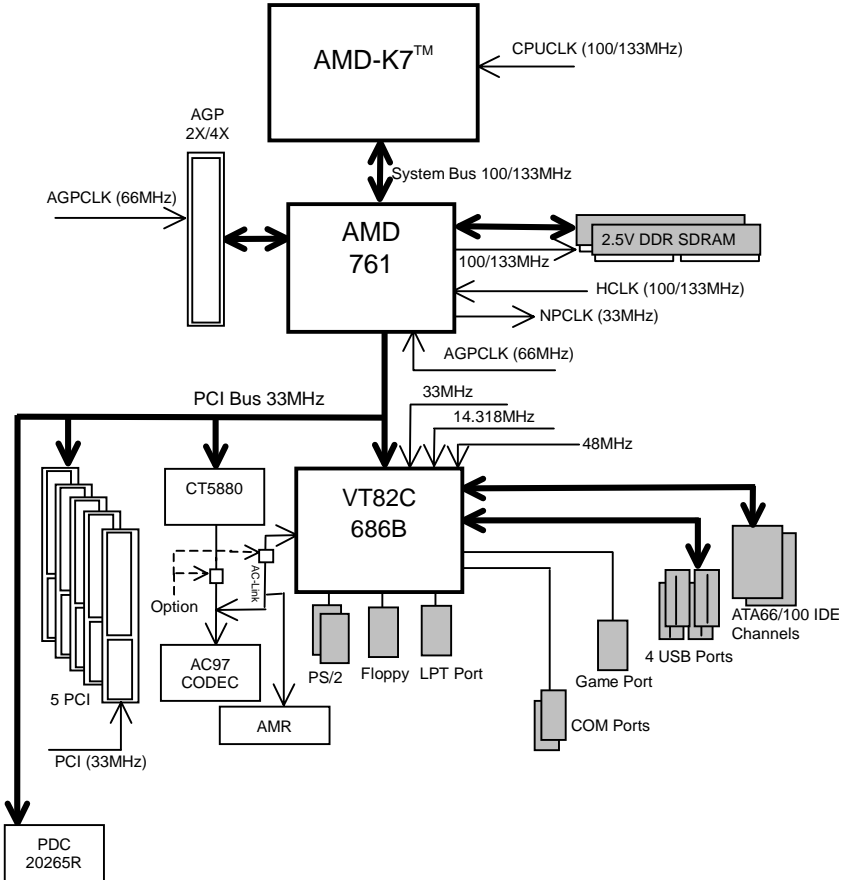

Suspend To RAM Installation

A.1 Introduce STR function:

Suspend-to-RAM (STR) is a Windows 98 ACPI sleep mode function. When recovering from STR (S3) sleep mode, the system is able, in just a few seconds, to retrieve the last "state" of the system before it went to sleep and recover to that state. The "state" is stored in memory (RAM) before the system goes to sleep. During STR sleep mode, your system uses only enough energy to maintain critical information and system functions, primarily the system state and the ability to recognize various "wake up" triggers or signals, respectively.

A.2 STR function Installation

Please use the following steps to complete the STR function installation.

Step-By-Step Setup

Step 1:

To utilize the STR function, the system must be in Windows 98 ACPI mode.

Putting Windows 98 into ACPI mode is fairly easy.

Setup with Windows 98 CD:

- A. Insert the Windows 98 CD into your CD-ROM drive, select Start, and then Run.
- B. Type (without quotes) "**D:\setup**" in the window provided. Hit the enter key or click OK.
- C. After setup completes, remove the CD, and reboot your system
(This manual assumes that your CD-ROM device drive letter is D:).

Step 2:

(If you want to use STR Function, please set jumper STR_EN Pin1-2 (Closed.)

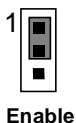
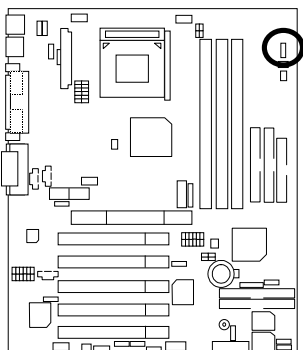

Pin No.	Definition
1-2 close	STR Enable
2-3 close	STR Disable (Default)

Step 3:

Power on the computer and as soon as memory counting starts, press . You will enter BIOS Setup. Select the item **"POWER MANAGEMENT SETUP"**, then select **"ACPI Sleep Type: S3 /STR"**. Remember to save the settings by pressing "ESC" and choose the **"SAVE & EXIT SETUP"** option.

Congratulation! You have completed the installation and now can use the STR function.

A.3 How to put your system into STR mode?

There are two ways to accomplish this:

1. Choose the "Stand by" item in the "Shut Down Windows" area.
 - A. Press the "Start" button and then select "Shut Down"



- B. Choose the "Stand by" item and press "OK"

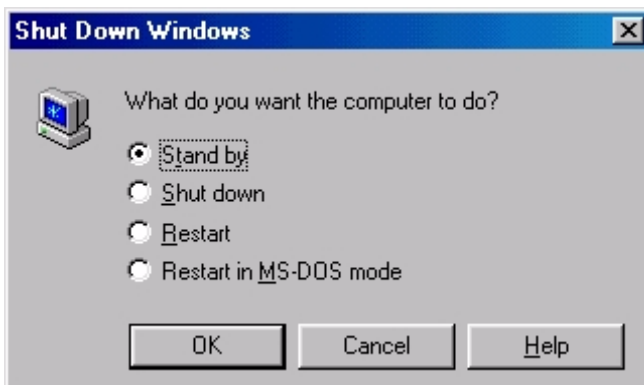

7DXR Motherboard

2. Define the system "power on" button to initiate STR sleep mode:
 - A. Double click "My Computer" and then "Control Panel"

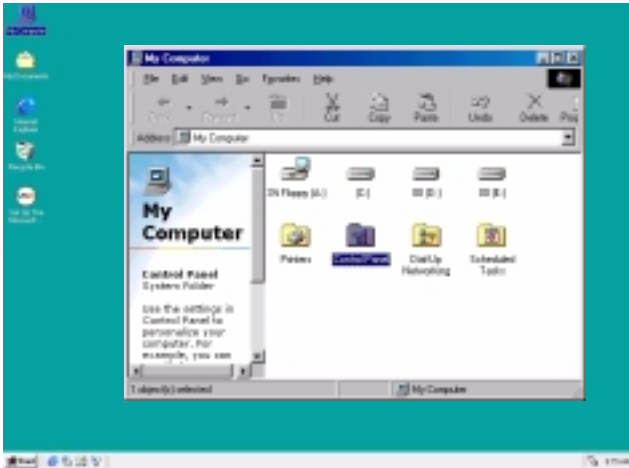

- B. Double click the " Power Management" item.

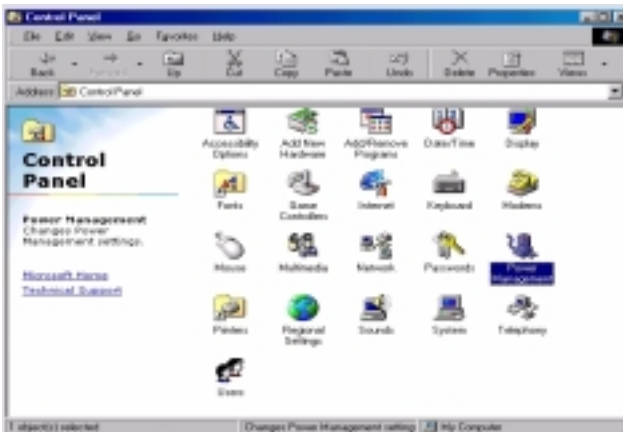

C. Select the "Advanced" tab and "Standby" mode in Power Buttons.



D. Restart your computer to complete setup.

Now when you want to enter STR sleep mode, just momentarily press the "Power on" button.

A.4 How to recover from the STR sleep mode?

There are seven ways to "wake up" the system:

1. Press the "Power On" button.
2. Use the "PS/2 Keyboard Power On" function.
3. Use the "PS/2 Mouse Power On" function.
4. Use the "Resume by Alarm" function.
5. Use the "Modem Ring On" function.
6. Use the "Wake On LAN" function.
7. Use the "USB Device Wake Up" function.

A.5 Notices:

1. In order for STR to function properly, several hardware and software requirements must be satisfied:
 - A. Your ATX power supply must comply with the ATX 2.01 specification (provide more than 720 mA 5V Stand-By current).
 - B. Your DDR SDRAM must be DDR-200 or DDR-266 compliant.

Dual BIOS Introduction

A. What is Dual BIOS Technology?

Dual BIOS means that there are two system BIOS (ROM) on the motherboard, one is the Main BIOS and the other is Backup BIOS. Under the normal circumstances, the system works on the Main BIOS. If the Main BIOS is corrupted or damaged, the Backup BIOS can take over while the system is powered on. This means that your PC will still be able to run stably as if nothing has happened in your BIOS.

B. How to use Dual BIOS?

a. Boot Screen

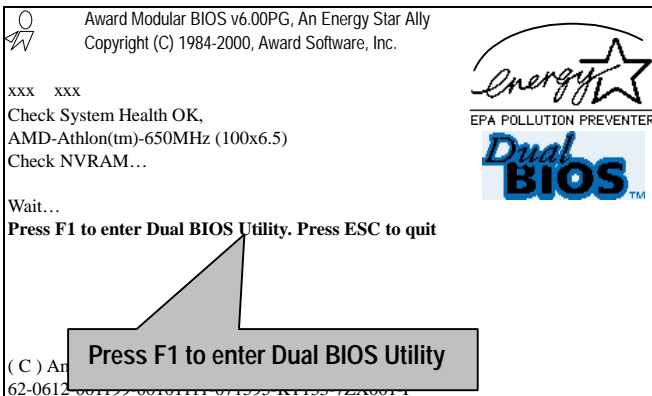

b. Dual BIOS Utility

Dual BIOS Utility V6.60.g.01K (C) 1999, Gigabyte Technology Co., LTD.	
Wide Range Protection	:Disabled
Halt On BIOS Defects	:Disabled
Auto Recovery	:Enabled
Boot From	:Main BIOS
BIOS Recovery	:Main to Backup
F3: Load Default	F5: Start BIOS Recovery
F7: Save And Restart	F9: Exit Without Saving
Use <Space> key to toggle setup	

c. Dual BIOS Item explanation:

Wide Range Protection: Disabled (Default), Enabled

Status 1:

If any failure (ex. Update ESCD failure, checksum error or reset...) occurs in the Main BIOS , just before the Operating System is loaded and after the power is on, and that the Wide Range Protection is set to "Enable", the PC will boot from Backup BIOS automatically.

Status 2:

If the ROM BIOS on peripherals cards(ex. SCSI Cards, LAN Cards,..) emits signals to request restart of the system after the user make any alteration on it, the boot up BIOS will not be changed to the Backup BIOS.

Halt On BIOS Defects: Disabled (Default), Enabled

If the BIOS occurs a checksum error or the Main BIOS occurs a WIDE RANGE PROTECTION error and Halt On BIOS Defects set to Enable, the PC will show messages on the boot screen, and the system will pause and wait for the user's instruction.

If Auto Recovery: **Disabled**, it will show *<or the other key to continue.>*

If Auto Recovery: **Enabled**, it will show *<or the other key to Auto Recover.>*

Auto Recovery: Enabled (Default), Disabled

When one of the Main BIOS or Backup BIOS occurs checksum failure, the working BIOS will automatically recover the BIOS of checksum failure.

(In the Power Management Setup of the BIOS Setting, if ACPI Suspend Type is set to Suspend to RAM, the Auto Recovery will be set to Enable automatically.)

(If you want to enter the BIOS setting, please press "Del" key when the boot screen appears.)

Boot From: Main BIOS (Default), Backup BIOS

Status 1:

The user can set to boot from main BIOS or Backup BIOS.

Status 2:

If one of the main BIOS or the Backup BIOS fails, this item "*Boot From: Main BIOS (Default)*" will become gray and will not be changed by user.

BIOS Recovery: Main to Backup

Auto recovery message:

BIOS Recovery: Main to Backup

The means that the Main BIOS works normally and could automatically recover the Backup BIOS.

BIOS Recovery: Backup to Main

The means that the Backup BIOS works normally and could automatically recover the Main BIOS.

(This auto recovery utility is set by system automatically and can't be changed by user.)



DualBIOS™ Technology FAQ

GIGABYTE Technology is pleased to introduce DualBIOS technology, a hot spare for your system BIOS. This newest "Value-added" feature, in a long series of innovations from GIGABYTE, is available on GA-7DXR motherboard. Future GIGABYTE motherboards will also incorporate this innovation.

What's DualBIOS™?

On GIGABYTE motherboards with DualBIOS there are physically two BIOS chips. For simplicity we'll call one your "Main BIOS" and the other we'll call your "Backup" BIOS (your "hot spare"). If your Main BIOS fails, the Backup BIOS almost automatically takes over on your next system boot. Almost automatically and with virtually zero down time! Whether the problem is a failure in flashing your BIOS or a virus or a catastrophic failure of the Main BIOS chip, the result is the same - the Backup BIOS backs you up, almost automatically.

I. Q: What is DualBIOS™ technology?

Answer:

DualBIOS technology is a patented technology from Giga-Byte Technology. The concept of this technology is based on the redundancy and fault tolerance theory. DualBIOS™ technology simply means there are two system BIOSes (ROM) integrated onto the motherboard. One is a main BIOS, and the other is a backup BIOS. The mainboard will operate normally with the main BIOS, however, if the main BIOS is corrupt or damaged for various reasons, the backup BIOS will be automatically used when the system powered-On. Your PC will operate as before the main BIOS was damaged, and is completely transparent to the user.

II. Q: Why does anyone need a motherboard with DualBIOS™ technology?

Answer:

In today's systems there are more and more BIOS failures. The most common reasons are virus attacks, BIOS upgrade failures, and/or deterioration of the BIOS (ROM) chip itself.

1. New computer viruses are being found that attack and destroy the system BIOS. They may corrupt your BIOS code, causing your PC to be unstable or even not boot normally.
2. BIOS data will be corrupted if a power loss/surge occurs, or if a user resets the system, or if the power button is pressed during the process of performing a system BIOS upgrade.
3. If a user mistakenly updates their mainboard with the incorrect BIOS file, then the system may not be able to boot correctly. This may cause the PC system hang in operation or during boot.
4. A flash ROM's life cycle is limited according to electronic characteristics. The modern PC utilizes the Plug and Play BIOS, and is updated regularly. If a user changes peripherals often, there is a slight chance of damage to the flash ROM.

With Giga-Byte Technology's patented DualBIOS™ technology you can reduce the possibility of hangs during system boot up, and/or loss BIOS data due to above reasons. This new technology will eliminate valuable system down time and costly repair bills cause by BIOS failures.

III. Q: How does DualBIOS™ technology work?

Answer:

1. DualBIOS™ technology provides a wide range of protection during the boot up procedure. It protects your BIOS during system POST, ESCD update, and even all the way to PNP detection/assignment.
2. DualBIOS™ provides automatic recovery for the BIOS. When the first BIOS used during boot up does not complete or if a BIOS checksum error occurs, boot-up is still possible. In the DualBIOS™ utility, the "Auto Recovery" option will guarantee that if either the main BIOS or backup BIOS is corrupted, the DualBIOS™ technology will use the good BIOS and correct the wrong BIOS automatically.
3. DualBIOS™ provides manual recovery for the BIOS. DualBIOS™ technology contains a built-in flash utility, which can flash your system BIOS from backup to main and/or visa versa. There is no need for an OS-dependent flash utility program.
4. DualBIOS™ contains a one-way flash utility. The built-in one-way flash utility will ensure that the corrupt BIOS is not mistaken as the good BIOS during recovery and that the correct BIOS (main vs. backup) will be flashed. This will prevent the good BIOS from being flashed.

IV. Q: Who Needs DualBIOS™ technology?

Answer:

1. Every user should have DualBIOS™ technology due to the advancement of computer viruses.
Everyday, there are new BIOS-type viruses discovered that will destroy your system BIOS. Most commercial products on the market do not have solutions to guard against this type of virus intrusion. The DualBIOS™ technology will provide a state-of-the-art solution to protect your PC:
Case I.) Vicious computer viruses may wipe out your entire system BIOS. With a conventional single system BIOS PC, the PC will not be functional until it is sent for repairs.
Case II.) If the "Auto Recovery" option is enabled in the DualBIOS™ utility, and if a virus corrupts your system BIOS, the backup BIOS will automatically reboot the system and correct the main BIOS.
Case III.) A user may override booting from the main system BIOS. The DualBIOS™ utility may be entered to manually change the boot sequence to boot from the backup BIOS.

2. During or after a BIOS upgrade, if DualBIOS™ detects that the main BIOS is corrupt, the backup BIOS will take over the boot-up process automatically. Moreover, it will verify the main and backup BIOS checksums when booting-up. DualBIOS™ technology examines the checksum of the main and backup BIOS while the system is powered on to guarantee your BIOS operates properly.
3. Power Users will have the advantage of having two BIOS versions on their mainboard. The benefit is being able to select either version BIOS to suit the performance system needs.
4. Flexibility for high-end desktop PCs and workstation/servers. In the DualBIOS™ utility, the option can be set, "Halt On When BIOS Defects," to be enabled to halt your system with a warning message that the main BIOS has been corrupted. Most workstation/servers require constant operation to guarantee services have not been interrupted. In this situation, the "Halt On When BIOS Defects" message may be disabled to avoid system pauses during normal booting. Another advantage you gain from Giga-Byte's DualBIOS™ technology is the ability to upgrade from dual 2 Mbit BIOS to dual 4 Mbit BIOS in the future if extra BIOS storage is need.

Four Speaker & SPDIF Introduction

Four Speaker Introduction

A. What is Four Speaker?

The Creative CT5880 audio chip can support up to 4 speaker output. If you select “Four speaker out”, Line In will be reconfigured as another line out to support a second pair of speakers.

B. How to use Four Speaker?

Microsoft Windows 98 Second Edition setup procedure:

- a. Click the audio icon along the task bar and select “Configure 3D Audio”

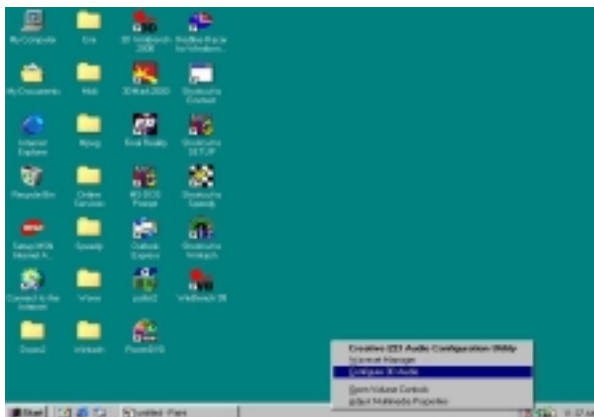

- b. Select two speaker (Default)

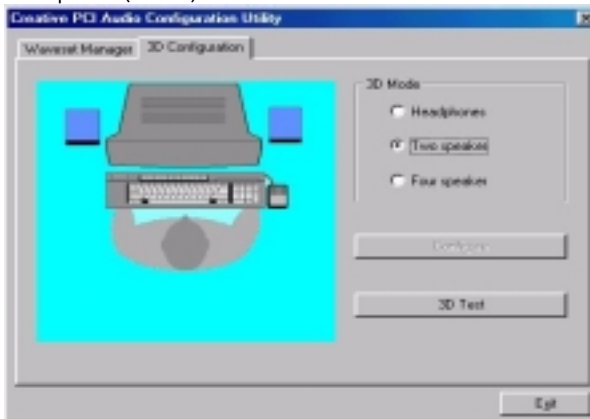

c. Select "Four speaker" item.

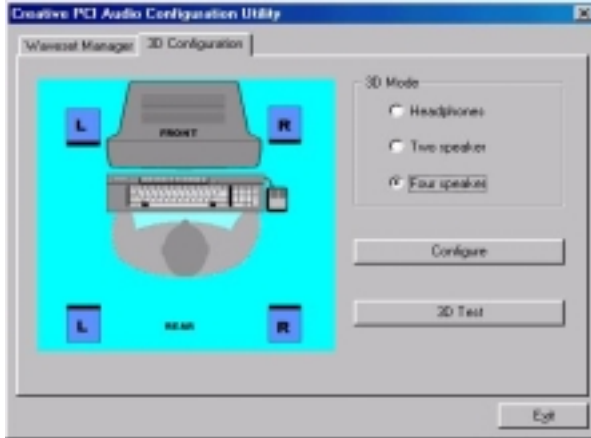

Microsoft Windows Me setup procedure:

a. Go to "Control Panel"

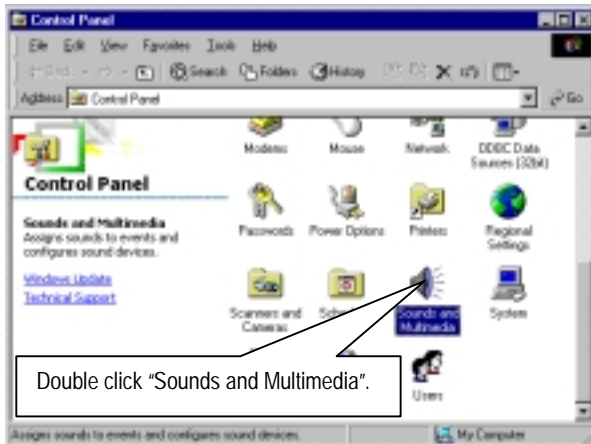

b. Select "Audio" Page, and click "Advanced" button.

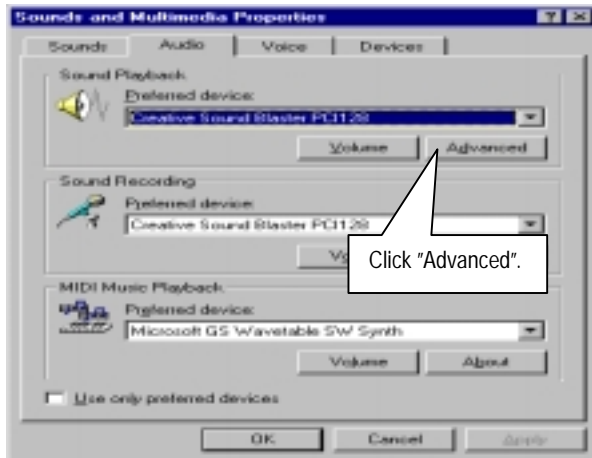

c. Select "Quadraphonic Speakers" and click ok.



C. Four Speaker Application

The four speaker function will only be supported in application softwares that use Microsoft DirectX and Creative EAX, for example, the game titles, software DVD player and MP3 player.

SPDIF Introduction

A. What is SPDIF?

The SPDIF output is capable of providing digital audio to external speakers or compressed AC3 data to an external Dolby digital decoder.

B. How to use SPDIF?

a. Click your mouse right button in "My Computer" and select the "Properties" item.

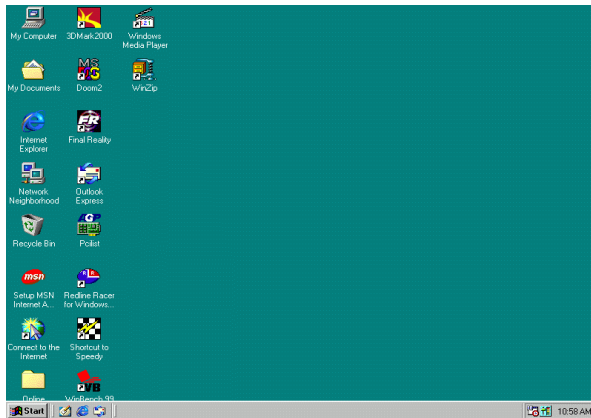

b. Click "Device Manager" item.

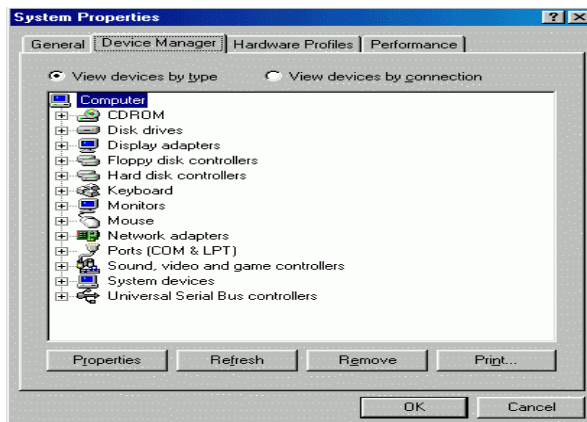

7DXR Motherboard

- c. Click “Sound, video and game controllers” item and select the “Creative Sound Blaster PCI128” item.

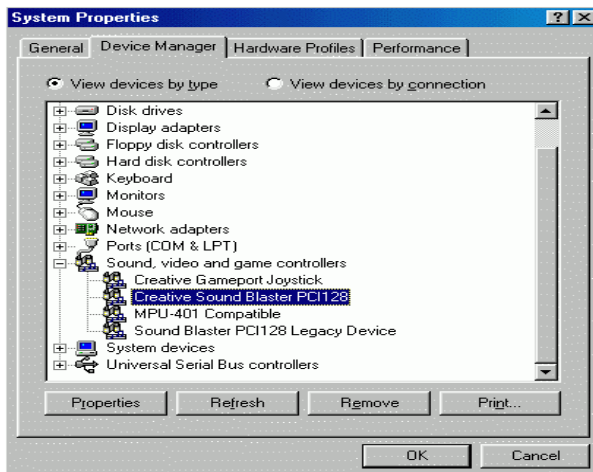

- d. Click “Settings” item and select the “Output Mode” item.

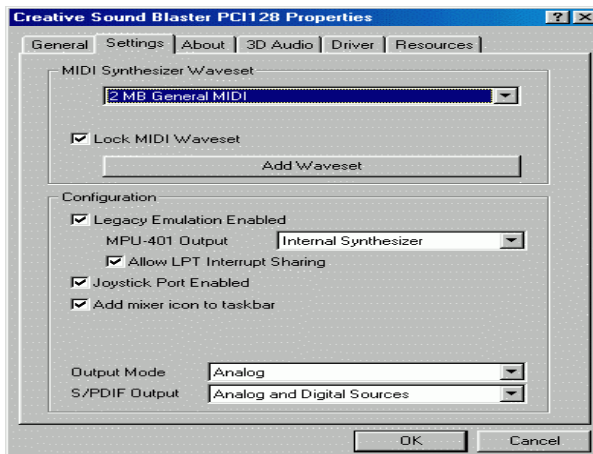

e. Click "Digital" item, Line Out will be reconfigure to SPDIF Out.

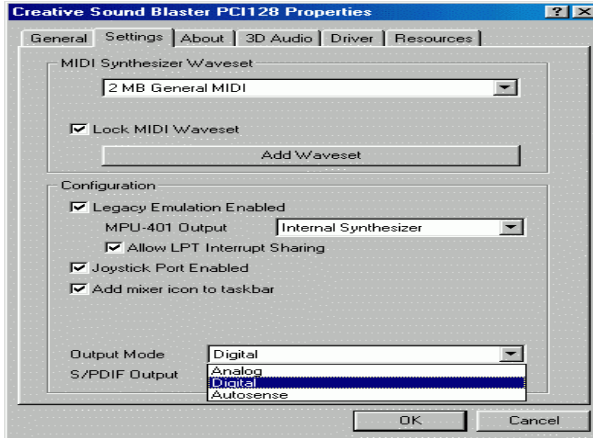

f. Recommend you to select "Autosense", It will automatically detect the type (mono or stereo) of the audio connector that you plug into Line Out audio jack, then configure Line Out to either SPDIF or Speaker accordingly.

@BIOS™ Introduction

Gigabyte announces @BIOS™ Windows BIOS live update utility



Have you ever updated BIOS by yourself? Or like many other people, you just know what BIOS is, but always hesitate to update it? Because you think updating newest BIOS is unnecessary and actually you don't know how to update it.

Maybe not like others, you are very experienced in BIOS updating and spend quite a lot of time to do it. But of course you don't like to do it too much. First, download different BIOS from website and then switch the operating system to DOS mode. Secondly, use different flash utility to update BIOS. The above process is not a interesting job. Besides, always be carefully to store the BIOS source code correctly in your disks as if you update the wrong BIOS, it will be a nightmare.

Certainly, you wonder why motherboard vendors could not just do something right to save your time and effort and save you from the lousy BIOS updating work? Here it comes! Now Gigabyte announces @BIOS™--the first Windows BIOS live update utility. This is a smart BIOS update software. It could help you to download the BIOS from internet and update it. Not like the other BIOS update software, it's a Windows utility. With the help of "@BIOS™", BIOS updating is no more than a click.

Besides, no matter which mainboard you are using, if it's a Gigabyte's product*, @BIOS™ help you to maintain the BIOS. This utility could detect your correct mainboard model and help you to choose the BIOS accordingly. It then downloads the BIOS from the nearest Gigabyte ftp site automatically. There are several different choices; you could use "Internet Update" to download and update your BIOS directly. Or you may want to keep a backup for your current BIOS, just choose "Save Current BIOS" to save it first. You make a wise choice to use Gigabyte, and @BIOS™ update your BIOS smartly. You are now worry free from updating wrong BIOS, and capable to maintain and manage your BIOS easily. Again, Gigabyte's innovative product erects a milestone in mainboard industries.

For such a wonderful software, how much it costs? Impossible! It's free! Now, if you buy a Gigabyte's motherboard, you could find this amazing software in the attached driver CD. But please remember, connected to internet at first, then you could have a internet BIOS update from your Gigabyte @BIOS™.

EasyTuneIII™ Introduction

Gigabyte announces EasyTuneIII™ Windows overdrive utility



“Overdrive” might be one of the most common issues in computer field. But have many users ever tried it? The answer is probably “no”. Because “overdrive” is thought to be very difficult and includes a lot of technical know-how, sometimes “overdrive” is

even considered as special skills found only in some enthusiasts.

But as to the experts in “overdrive”, what’s the truth? They may spend quite a lot of time and money to study, try and use many different hardware and software tools to do “overdrive”. And even with these technologies, they still learn that it’s quite a risk because the safety and stability of an “overdrive” system is unknown.

Now everything is different because of a Windows overdrive utility EasyTuneIII™ --announced by Gigabyte. This utility has totally changed the gaming rule of “overdrive”. This is the first overdrive utility suitable for both normal and power users. Users can choose either “Easy Mode” or “Advanced Mode” to run “overdrive” at their convenience. For users who choose “Easy Mode”, they just need to click “Auto Optimize” to have auto and immediate CPU overclocking. This software will then overdrive CPU speed automatically with the result being shown in the control panel. If someone prefers to “overdrive” by oneself, there is also another choice. Click “Advanced Mode” to enjoy “sport drive” class overclocking. In “Advanced Mode”, one can change the system bus speed in small increments to get ultimate system performance. And no matter which mainboard is used, if it’s a Gigabyte’s product*, EasyTuneIII™ helps to perform the best of system.

Besides, different from other traditional over-clocking methods, EasyTuneIII™ doesn’t require users to change neither BIOS nor hardware switch/ jumper setting; on the other hand, they can do “overdrive” at only one click. Therefore, this is a safer way for “overdrive” as nothing is changed on software or hardware. If user runs EasyTuneIII™ over system’s limitation, the biggest lost is only to restart the computer again and the side effect is then well controlled. Moreover, if one well-performed system speed been tested in EasyTuneIII™, user can “Save” this bus speed and “Load” it in next time. Obviously, Gigabyte EasyTuneIII™ has already turned the “overdrive” technology toward to a newer generation.

7DXR Motherboard

This wonderful software is now free bundled in Gigabyte motherboard attached driver CD. Users may make a test drive of "EasyTuneIII™" to find out more amazing features by themselves.

For further technical information, please link to: <http://www.gigabyte.com.tw>

※ **Note: For the latest version of EasyTuneIII™, please visit our website.**

Raid Introduction

What is RAID?

This motherboard implements two different types of RAID levels as follows:

RAID 0 (stripe)

For capacity -- The motherboard array will be as big as the smallest HDD in the array times however many HDDs are in the array. Any larger HDDs will simply be truncated. The truncated space on the bigger HDDs will then be unusable.

For sustained data transfers -- A RAID 0 array consisting of two HDDs will transfer at about twice the speed of the slowest HDD in the array. A RAID 0 array consisting of four HDDs will transfer at about three times the speed of the slowest HDD in the array.

RAID 1 (mirror)

For capacity -- This Motherboard array will be as big as the smallest HDD in the array. The larger HDD will simply be truncated. The truncated space on the bigger HDD will then be unusable.

For sustained data transfers -- This motherboard array will write data at the rate of the slowest HDD in the array. This motherboard array will read data at twice the rate of the slowest HDD in the array.

About RAID Levels

Striping (RAID 0)

Reads and writes sectors of data interleaved between multiple drives. When any disk member fails, it affects the entire array. Performance is better than a single drive since the workload is balanced between the array members. This array type is for high performance systems. Identical drives are recommended for performance as well as data storage efficiency. The disk array data capacity is equal to the number of drive members times the smallest member capacity. For example, one 1GB and 1 drives will form a 2GB (2 x 1GB) disk array.

Stripe Size - a value can be set from 1KB to 1024KB sector size. The size can directly affect performance. In the FastBuild BIOS, the "Desktop" default is 8KB while "Server" and "A/V Editing" are 64KB.

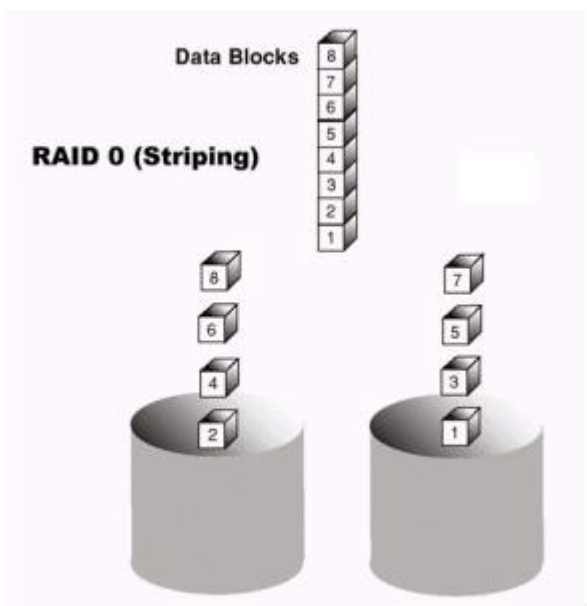

Mirroring (RAID 1)

Writes duplicate data on to a pair of drives while reads are performed in parallel. ATA RAID 1 is fault tolerant because each drive of a mirrored pair is installed on separate IDE channels. If one of the mirrored drives suffers a mechanical failure (e.g. spindle failure) or does not respond, the remaining drive will continue to function. This is called **Fault Tolerance**. If one drive has a physical sector error, the mirrored drive will continue to function.

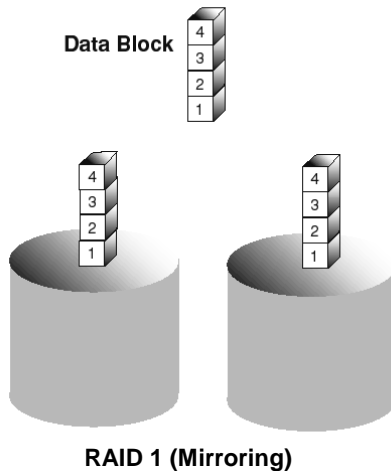

On the next reboot, the FastBuild™ utility will display an error in the array and recommend to replace the failed drive. Users may choose to continue using their PC, however Promise recommends replacing the failed drive as soon as possible. See Chapter 4 for a functional description.

Due to redundancy, the drive capacity of the array is half the total drive capacity. For example, two 1GB drives that have a combined capacity of 2GB would have 1GB of usable storage. With drives of different capacities, there may be unused capacity on the larger drive.

Creating Your Disk Array

You will now use the FastBuild BIOS utility to create your array using the attached drives. There are two different scenarios in creating this array. You can create an array for performance, you can create a Security array using new hard drives (recommended).



WARNING: *If creating a Security array using an existing hard drive, backup any necessary data. Failure to follow this accepted PC practice could result in data loss.*

1. Boot your system. If this is the first time you have booted with RAID, the FastBuild BIOS will display the following screen.

```
FastTrak100 (tm) "Lite" BIOS Version 1.xx (Build xxxx)
(c) 1995-2000 Promise Technology, Inc. All Rights Reserved.
```

```
No array defined . . .
```

```
Press <Ctrl-F> to enter FastBuild (tm) Utility
Or press <ESC> key to continue booting the system.
```

2. Press <Ctrl-F> keys to display the FastBuild (tm) Utility Main Menu
3. Press "1" to display the Auto Setup Menu below. This is the fastest and easiest method to creating your first array.

```
FastBuild (tm) Utility 1.xx (c) 1995-2000 Promise Technology, Inc.
[Auto Setup Options Menu]
```

```
Optimize Array for:      Performance
Typical Application usage:  A/V Editing
```

```
[ Auto Setup Configuration ]
```

```
Mode.....Stripe
Spare Driver.....0
Drives used in Array.....2
Array Disk Capacity..... 16126
```

```
[ Keys Available ]
```

```
[↑] Up [↓] Down  [←, →, Space] Change Option  [ESC] Exit  [Ctrl-Y] Save
```

Creating an Array for Performance

NOTE: This motherboard allows users to create striped arrays with 1, 2 drives.

To create an array for best performance, follow these steps:

1. Using the Spacebar, choose "Performance" under the **Optimize Array for** section.
2. Select how you will use your PC most under the **Typical Application usage** section. The choices are A/V Editing, Server, and Desktop (the default).
3. Press <Ctrl-Y> keys to Save and create the array.
4. Reboot your system.
5. Once the array has been created, you will need to FDISK and format the array as if it were a new single hard drive.
6. Proceed to Installing Drivers section of the manual (see **RAID Manual of the TUCD**).

Creating a Security Array With New Drives

NOTE: This motherboard permit only two drives to be used for a single Mirrored array in Auto Setup.

To create an array for data protection using new hard drives, follow these steps:

1. Using the Spacebar, choose "Security" under the **Optimize Array for** section.
2. Press <Ctrl-Y> keys to Save your selection.
3. The window below will appear.

Do you want the disk image to be duplicated to another? (Yes/No) Y - Create and Duplicate N - Create Only

4. Press "N" for the Create Only option.
5. A window will appear almost immediately confirming that your Security array has been created. Press any key to reboot the system

Array has been created. <Press Any Key to Reboot>

6. Proceed with normal FDISK and format procedures as if you had just installed a new hard drive.
7. Once the arrayed drives have been formatted, proceed to the **Installing Driver** chapter (see **RAID Manual of the TUCD**) to install your operating system.

Creating a Security Array With An Existing Data Drive

NOTE: This motherboard permits only two drives to be used for a single Mirrored array in Auto Setup.

You would use this method if you wish to use a drive that already contains data and/or is the bootable system drive in your system. You will need another drive of identical or larger storage capacity.



WARNING: Backup any necessary data before proceeding. Failure to follow this accepted PC practice could result in data loss.



WARNING: If you wish to include your current bootable drive using the Windows NT 4.x or Windows 2000 operating system as part of a bootable Mirrored (RAID 1) array on your system, do NOT connect the hard drive to the motherboard controller yet. You MUST install the Windows NT4 or 2000 driver software first (see **RAID Manual of the TUCD**) to this drive while it is still attached to your existing hard drive controller. For all other Operating Systems, proceed here.

Follow these steps:

1. Using the Spacebar, choose "Security" under the **Optimize Array for** section.
2. Press <Ctrl-Y> keys to Save your selection. The window below will appear.

Do you want the disk image to be duplicated to another? (Yes/No) Y - Create and Duplicate N - Create Only

3. Press "Y" for the Create and Duplicate option. The window below will appear asking you to select the Source drive to use. FastBuild will copy all data from the Source drive to the Target drive.

Source Disk		
Channel:ID	Drive Model	Capacity (MB)
Target Disk		
Channel:ID	Drive Model	Capacity (MB)
[Please Select A Source Disk]		
Channel:ID	Drive Model	Capacity (MB)
1 :Master	QUANTUMCR8.4A	8063
2 :Master	QUANTUMCR8.4A	8063
[↑] Up [↓] [ESC] Exit [Ctrl-Y] Save		

4. Use the arrow keys to choose which drive contains the existing data to be copied.
5. Press [Ctrl-Y] keys to Save selection and start duplication. The following progress screen will appear.

Start to duplicate the image . . .
Do you want to continue? (Yes/No)
Y – Continue N - Abort

6. Select "Y" to continue. If you choose "N" , you will be returned to step 1.
7. Once complete, the following screen will appear confirming that your Security array has been created. Press any key to reboot the system

Array has been created.
<Press Any Key to Reboot>

8. Proceed to the **Installing Driver** chapter (see **RAID Manual of the TUCD**) to install the RAID driver and/or operating system.

Using FastBuild™ Configuration Utility

The FastBuild™ Configuration Utility offers several menu choices to create and manage the drive array on the motherboard. For purposes of this manual, it is assumed you have already created an array in the previous chapter and now wish to make a change to the array or view other options.

Viewing BIOS Screen

When you boot your system with the RAID function and drives installed, the FastBuild BIOS will detect the drives attached and show the following screen.

```
FastTrak100 (tm)"Lite" BIOS Version 1.xx (Build xx)
(c) 1995-2000 Promise Technology, Inc. All Rights Reserved.

Scanning IDE drives . . . . .
```

If an array exists already, the BIOS will display the following screen showing the board RAID BIOS version and status of the array.

```
FastTrak100 (tm) "Lite" BIOS Version 1.xx (Build xxxx)
(c) 1995-2000 Promise Technology, Inc. All Rights Reserved.

  ID      MODE SIZE      TRACK-MAPPING      STATUS
  1 *      1*2 Mirror      16126M  611/128/32      Functional

Press <Ctrl-F> to enter FastBuild (tm) Utility....
```

The array status consists of three possible conditions: *Functional*, *Critical*, *Offline*.

Functional - The array is operational.

Critical - A mirrored array contains a drive that has failed or disconnected. The remaining drive member in the array is functional. However, the array has temporarily lost its ability to provide fault tolerance. The user should identify the failed drive through the FastBuild™ Setup utility, and then replace the problem drive.

Offline - A striped array has 1 drive that has failed or been disconnected. When the array condition is "offline," the user must replace the failed drive(s), then restore data from a backup source.

Navigating the FastBuild™ Setup Menu

When using the menus, these are some of the basic navigation tips: Arrow keys highlights through choices; [Space] bar key allows to cycle through options; [Enter] key selects an option; [ESC] key is used to abort or exit the current menu.

Using the Main Menu

This is the first option screen when entering the FastBuild™ Setup.

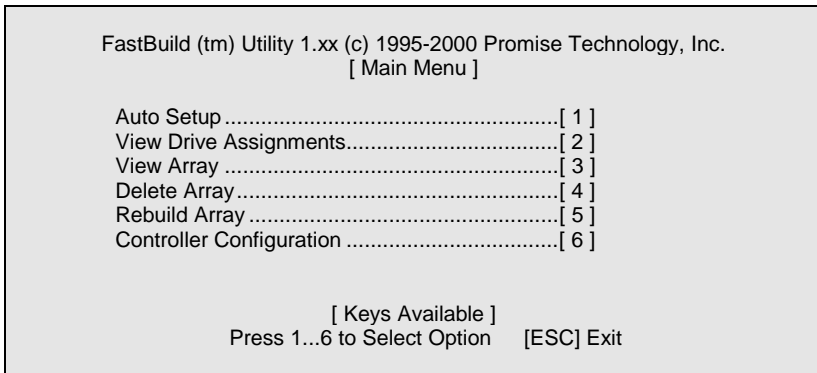

To create a new array automatically, follow the steps under “Creating Arrays Automatically” on page 71. Promise recommends this option for most users.

To view drives assigned to arrays, see “Viewing Drive Assignments” on page 73.

To delete an array (but not delete the data contained on the array), select “Deleting An Array” on page 80.

To rebuild a mirrored array, see “Rebuilding an Array” on page 82.

To view controller settings, see “Viewing Controller Configuration” on page 84.



NOTE: After configuring an array using FastBuild, you should FDISK and format the arrayed drive(s) if you are using new, blank drives. Depending on the type of array you are using.

Creating Arrays Automatically

The Auto Setup <1> selection from the Main Menu can intuitively help create your disk array. It will assign all available drives appropriate for the disk array you are creating. After making all selections, use Ctrl-Y to Save selections. FastBuild will automatically build the array.

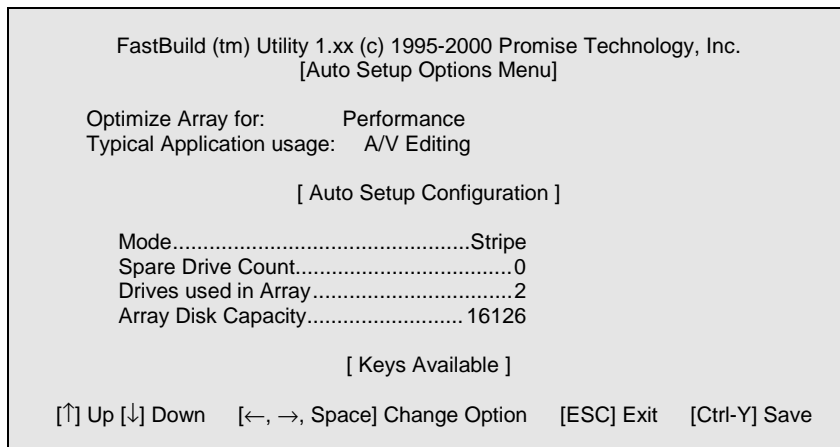

Optimize Array For

Select whether you want Performance (RAID 0), Security (RAID 1) under the "Optimize Array for" setting.

Performance (RAID 0 Striping)

Supports the maximum performance. The storage capacity equals the number of drives times the capacity of the smallest drive in the disk array.

NOTE: This motherboard permits striped arrays using 1, 2 drive attached in Auto Setup mode.

Security (RAID 1 Mirroring)

Creates a mirrored (or fault tolerant) array for data security.

NOTE: Under the Security setting, This motherboard permits two drives to be used for a single Mirrored array only.

Defining Typical Application Usage

Allows the user to choose the type of PC usage that will be performed in order to optimize how *This motherboard* handles data blocks to enhance performance. Your choice will determine the block size used. You may choose from: A/V Editing (for audio/video applications, or any similar application that requires large file transfers), Server (for numerous small file transfers), or Desktop (a combination of large and small file sizes).

Creating Multiple Disk Arrays

1. If you plan to create multiple arrays, attach only the drives necessary to create the first disk array and complete the <1> Auto Setup.
2. Install the additional drives needed for the second array and again use the <1> Auto Setup.

NOTE: *If you wish to customize the settings of individual disk arrays (such as block size), you must manually create disk arrays with the Define Array <3> option from the Main Menu.*

Viewing Drive Assignments

The View Drive Assignments <2> option in the Main Menu displays whether drives are assigned to a disk arrays or are unassigned.

Under the "Assignment" column, drives are labeled with their assigned disk array or shown as "Free" if unassigned. Such "Free" drives can be used for a future array. Unassigned drives are not accessible by the OS. The menu also displays the data transfer mode that relates to speed used by each drive (U5 refers to 100MB/sec transfers, U4 refers to 66MB/sec transfers, etc...)

FastBuild (tm) Utility 1.xx (c) 1995-2000 Promise Technology, Inc.
[View Drive Assignments]

Channel:ID	Drive Model	Capacity(MB)	Assignment	Mode
1 : Master	QUANTUMCR8.4A	8063	Array 1	U5
1 : Slave	QUANTUMCR8.4A	8063	Free	U5
2 : Master	QUANTUMCR8.4A	8063	Array 1	U5

[Keys Available]

[↑] Up [↓] Down [ESC] Exit Mode (U=UDMA, P=PIO, D=DMA)

Manually Creating an Array

The Define Array <3> option from the Main Menu allows users to begin the process of manually defining the drive elements and RAID levels for one or multiple disk arrays attached to this motherboard. Users will commonly create one or two drive arrays with the motherboard, though the motherboard will support a maximum of four arrays¹.

NOTE: For most installations, We recommends the <1> Auto Setup for easy disk array creation.

FastBuild (tm) Utility 1.xx (c) 1995-2000 Promise Technology, Inc.
[Define Array Menu]

Array No	RAID Mode	Total Drv	Capacity(MB)	Status
Array 1	Stripe	2	16126	Functional
Array 2	_____	_____	_____	_____
Array 3	_____	_____	_____	_____
Array 4	_____	_____	_____	_____

[Keys Available]

Note: * — Bootable Array

[↑] Up [↓] Down [ESC] Exit [Enter] Select [Space] Change Boot Drive

1. To manually create an array from the Define Array Menu, use the arrow keys to highlight the array number you wish to define, and press [Enter] to select.
2. The Define Array Definition Menu will next appear that allows drive assignments to the disk array (see next page).

¹ A user may use a single drive in either striping mode with system. In this rare scenario, the motherboard will create an individual array ID but will offer conventional controller performance, depending on the drive type. At a later time, a second drive can be added to the array and the array re-created to support RAID 1 mirroring.

Selecting Array Type

- Under the Definition section of this menu, highlight the Array # for which you want to assign a RAID level.
- Use the [Space] key to cycle through two array types: Performance (RAID 0 Striping), Security (RAID 1 Mirroring).

```

FastBuild (tm) Utility 1.xx (c) 1995-2000 Promise Technology, Inc.
[ Define Array Definition Menu ]

Array No  RAID Mode  Total Drv  Capacity(MB)  Status
Array 1     Stripe      2         16126           Functional

Stripe Block:  64 KB

[ Drive Assignments ]

Channel:ID  Drive Model  Capacity (MB)  Assignment
1 :           MasterQUANTUMCR8.4A  8063            Y
1 :           Slave  QUANTUMCR8.4A  8063            N
2 :           MasterQUANTUMCR8.4A  8063            Y

[ Keys Available ]

[↑] Up [↓] Down  [ESC] Exit  [Space] Select  [Ctrl-Y] Save

```

Selecting Stripe Block

For RAID 0 Striped arrays only, you may manually select the "stripe block size." Use the Spacebar to scroll through choices progressing as follows (1, 2, 4, 8, 16 . . . 1024).

The size selected affects how motherboard sends and retrieves data blocks from the drives. You will need to perform your own testing to determine how the data block size is affecting your particular use of the array. In general, a larger block size is better when handling large data transfers (such as in A/V editing or graphics) while a smaller block size is better when handling e-mail and other common server data. The default is 64K.

Assigning Drive(s) to Array

- Under the [Drive Assignments] section, highlight a drive using the [↑] Up [↓] keys.
- With the [Space] bar key, change the Assignable option to "Y" to add the drive to the disk array.

3. Press <Ctrl-Y> to save the disk array information. Depending on the array type selected, the following scenarios will take place:
 - a) If choosing a Striping array, the initial Define Array Menu screen will appear with the arrays defined. From there you may ESC to exit and return to the Main Menu of FastBuild.
 - b) If you selected a Mirroring array for two drives, there is an additional window that appears as described in order to create the array. To do this you will use either two brand new drives, or one drive that contains existing data that you wish to mirror.

Creating A Mirrored Array Using New Drives

As described in the Drive Assignments Option section above, if you selected a mirroring array and wish to use two new assigned drives, follow the directions here.

1. After assigning new drives to a Mirroring array and saving the information with <Ctrl-Y>, the window below will appear.

Do you want the disk image to be duplicated to another? (Yes/No)
 Y - Create and Duplicate
 N - Create Only

2. Press "N" for the Create Only option.
3. A window will appear almost immediately confirming that your Security array has been created. Press any key to reboot the system

Array has been created.
 <Press Any Key to Reboot>

Adding Fault Tolerance to an Existing Drive

This motherboard will create a mirrored array using an existing system drive with data. You must assign the existing drive and another drive of same or larger capacity to the Mirroring array. The BIOS will send the existing data to the new blank drive.



WARNING: Backup any necessary data before proceeding. Failure to follow this accepted PC practice could result in data loss.

WARNING: If you wish to include your current bootable drive using the Windows NT 4.x or Windows 2000 operating system as part of a bootable Mirrored (RAID 1) array on your system, do NOT connect the hard drive to the system controller yet. You MUST install the Windows NT4 or 2000 driver software first (see **RAID Manual of the TUCD**) to this drive while it is still attached to your existing hard drive controller. For all other Operating Systems, proceed here.

7DXR Motherboard

After assigning the drives to a Mirroring array, press <Ctrl-Y> keys to Save your selection. The window below will appear.

Do you want the disk image to be duplicated to another? (Yes/No)
Y - Create and Duplicate
N - Create Only

1. Press "Y" for the Create and Duplicate option. The window below will appear asking you to select the Source drive to use. FastBuild will copy all data from the Source drive to the Target drive.

Channel:ID	Source Disk Drive Model	Capacity (MB)
	Target Disk Drive Model	Capacity (MB)
[Please Select A Source Disk]		
Channel:ID	Drive Model	Capacity (MB)
1 :Master	QUANTUMCR8.4A	8063
2 :Master	QUANTUMCR8.4A	8063
[↑] Up [↓] [ESC] Exit [Ctrl-Y] Save		

2. Use the arrow keys to choose which drive contains the existing data to be copied.



WARNING: All target drive data will be erased. Make sure you choose the correct drive.

3. Press [Ctrl-Y] keys to Save selection and start duplication. The following confirmation screen will appear.

Start to duplicate the image . . .
Do you want to continue? (Yes/No)
Y - Continue N - Abort

4. Select "Y" to continue. If you choose "N", you will be returned to step 1.
5. Once "Y" is selected, the following progress screen will appear. The process will take a few minutes.

Please Wait While Duplicating The Image

10% Complete

- Once mirroring is complete, the following screen will appear confirming that your Security array has been created. Press any key to reboot the system

Array has been created.
 <Press Any Key to Reboot>

Making a Disk Array Bootable



WARNING: In order for you to boot from an array on the system, your PC or server must be configured in the CMOS Setup to use the system as a bootable device (versus the onboard controller). This option is not available if the system is being used as a secondary controller.

- Once you have returned to the Define Array Menu window (below), you will see the array(s) you have created. You now may use the menu to select which previously-defined array will be used as the bootable array.

FastBuild (tm) Utility 1.xx DELL (c) 1995-2000 Promise Technology, Inc.
 [Define Array Menu]

Array No	RAID Mode	Total Drv	Capacity(MB)	Status
* Array 1	Stripe	2	13044	Functional

Note: * — Bootable Array

[↑] Up [↓] Down [ESC] Exit [Enter] Select [Space] Change Boot Drive

- Highlight the array which you want to boot from using the [↑] Up [↓] Down keys.
- Press the [Space] bar key.
- An * asterisk will appear next to the array number indicating it as bootable. The system will now recognize this array as the first array seen
- The system will then use this bootable array as the (fixed) boot C: drive.

NOTE: The bootable array must contain your configured operating system.

How Orders Arrays

During startup, the disk arrays on the motherboard are recognized in this order: 1) The array set to bootable in the FastBuild™ Setup, and 2) the Array number (i.e. Array 0, Array 1...).

This would be involved in determining which drive letters will be assigned to each disk array.

How Saves Array Information

All disk array data is saved into the reserved sector on each array member. We suggests that users record their disk array information for future reference.

Another feature of the motherboard disk array system is to recognize drive members even if drives are moved between different motherboard connectors(IDE3&IDE4). Since each drive's array data identifies itself to the array, it is possible to move or swap drives without modifying the array setup. This is valuable when adding drives, or during a rebuild.

Deleting An Array

The Delete Array <4> Menu option allows for deletion of disk array assignments. This is not the same as deleting data from the drives themselves. If you delete an array by accident (and before it has been used again), the array can normally be recovered by defining the array identically as the deleted array.



WARNING: Deleting an existing disk array could result in its data loss. Make sure to record all array information including the array type, the disk members, and stripe block size in case you wish to undo a deletion.

FastBuild (tm) Utility 1.xx (c) 1995-2000 Promise Technology, Inc.				
[Delete Array Menu]				
Array No	RAID Mode	Total Drv	Capacity(MB)	Status
Array 1	Mirror	2	8063	Functional
Array 2	Stripe	1	8063	Functional
Array 3	Stripe	1	8063	Functional
Array 4	_____	_____	_____	_____
[Keys Available]				
[↑] Up [↓] Down		[ESC] Exit	[Del] Delete	

1. To delete an array, highlight the Array you wish to delete and press the [Del] key.
2. The View Array Definition menu will appear (see below) showing which drives are assigned to this array.

FastBuild (tm) Utility 1.xx (c) 1995-2000 Promise Technology, Inc.				
[Define Array Menu]				
Array No	RAID Mode	Total Drv	Capacity(MB)	Status
Array 1	Mirror	2	8063	Functional
Stripe Block: 64 KB				
[Drive Assignments]				
Channel:ID	Drive Model	Capacity (MB)	Assignment	
1 : Master	QUANTUMCR8.4A	8063	Y	
2 : Master	QUANTUMCR8.4A	8063	Y	

7DXR Motherboard

3. Confirm yes to the following warning message with the <Ctrl-Y> key to continue array deletion:

Are you sure you want to delete this array?
Press Ctrl-Y to Delete, others to Abort

4. After deleting the array, you should create a new array using Auto Setup or the Define Array menu from the FastBuild Main Menu.

Rebuilding A Mirrored Array

The Rebuild Array <5> Menu option is necessary to recover from an error in a mirrored disk array. You will receive an error message when booting your system from the BIOS.

NOTE: Drives *MUST* be replaced if they contain any physical errors.

Follow these steps BEFORE using the Rebuild Array menu option:

1. On bootup, the system Startup BIOS will display an error message identifying which drive has failed.
2. Press <Ctrl-F> keys to enter FastBuild Main Menu.
3. Select submenu Define Array <3>.
4. Select the failed array and identify the Channel and ID of the failed drive.
5. Power off and physically remove the failed drive.
6. Replace the drive with an identical model.
7. Reboot the system and enter the FastBuild Main Menu.
8. Select the <5> Rebuild Array option. The following screen will appear.

FastBuild (tm) Utility 1.xx (c) 1995-2000 Promise Technology, Inc.				
[Rebuild Array Menu]				
Array No	RAID Mode	Total Drv	Capacity(MB)	Status
Array 1	Mirror	2	16126	Critical
Array 2	Stripe	1	8063	Functional
Array 3	Stripe	1	8063	Functional
Array 4	_____	_____	_____	_____
[Keys Available]				
[↑] Up [↓] Down [ESC] Exit [Enter] Select				

9. Highlight the array whose Status is "Critical".
10. Press [Enter]. The following screen will then appear (see next page).

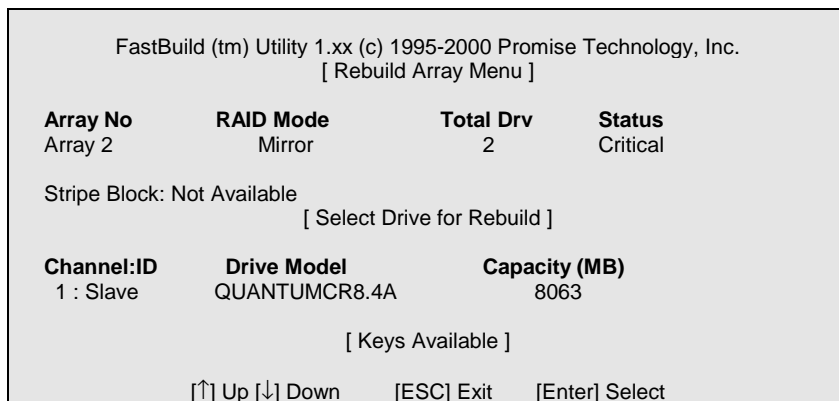

11. Under [Select Drive for Rebuild], highlight the replacement drive.
12. Press [Enter] and confirm that the data will be copied on to the selected drive. All data on the replacement drive will be written over with mirrored information from the array drive. A progress bar will appear as below.

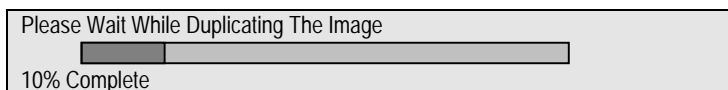

13. Once the rebuild process is complete, the user will be asked to reboot the system.

Viewing Controller Settings

The Controller Configuration <6> menu selection allows you to enable or disable the BIOS from halting (the default) if it detects an error on boot up. You may also view the system resources (Interrupt and I/O port address) of data channels.

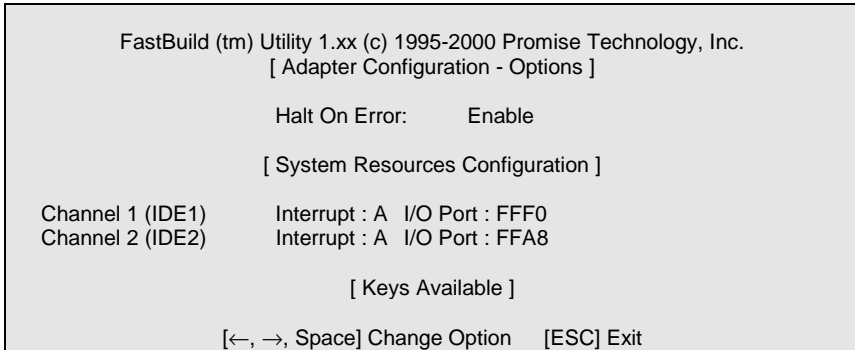

Halting BIOS On Bootup Errors

The [Adapter Configuration – Options] section allows you to enable or disable The system to Halt operation at the BIOS startup screen should an error be detected. This is the only option that can be changed on this screen.

Viewing System Resources

The [System Resources Configuration] section of this submenu displays the PCI slot interrupt and port address used by the system. The resources used are determined by the Mainboard PCI PnP BIOS for the PCI slot in which the system resides.

In the rare case that there is a resource conflict, refer to the Mainboard BIOS documentation on changes on resources allocated to the system PCI slot.

7DXR Motherboard

Page Index for BIOS Setup	Page
The Main Menu	P.87
Standard CMOS Features	P.90
Advanced BIOS Features	P.94
Advanced Chipset Features	P.96
Integrated Peripherals	P.100
Power Management Setup	P.105
PnP / PCI Configurations	P.109
PC Health Status	P.111
Frequency / Voltage Control	P.113
Load Fail-Safe Defaults	P.114
Load Optimized Defaults	P.115
Set Supervisor / User Password	P.116
Save & Exit Setup	P.117
EXIT Without Saving	P.118

BIOS Setup

BIOS Setup is an overview of the BIOS Setup Interface. The interface allows users to modify the basic system configuration, which is stored in battery-backed CMOS RAM so that the Setup information can be retained when the power is turned off.

ENTERING SETUP

Power ON the computer and press immediately will allow you to enter Setup. If unsuccessful, you can restart the system and try again by pressing the "RESET" button on the system case. You may also restart by simultaneously pressing <Ctrl> – <Alt>– keys.

CONTROL KEYS

<↑>	Move to previous item
<↓>	Move to next item
<←>	Move to the item in the left hand
<→>	Move to the item in the right hand
<Esc>	Main Menu - Quit and not save changes into CMOS Status Page Setup Menu and Option Page Setup Menu - Exit current page and return to Main Menu
<+/PgUp>	Increase the numeric value or make changes
<-/PgDn>	Decrease the numeric value or make changes
<F1>	General help, only for Status Page Setup Menu and Option Page Setup Menu
<F2>	Reserved
<F3>	Reserved
<F4>	Reserved
<F5>	Restore the previous CMOS value from CMOS, only for Option Page Setup Menu
<F6>	Load the default CMOS value from BIOS default table, only for Option Page Setup Menu
<F7>	Load the Optimized Defaults
<F8>	Reserved
<F9>	Reserved
<F10>	Save all the CMOS changes, only for Main Menu

GETTING HELP

Main Menu

The on-line description of the highlighted setup function is displayed at the bottom of the screen.

Status Page Setup Menu / Option Page Setup Menu

Press F1 to pop up a small help window that describes the appropriate keys to use and the possible selections for the highlighted item. To exit the Help Window press <Esc>.

The Main Menu

Once you enter Award BIOS CMOS Setup Utility, the Main Menu (Figure 1) will appear on the screen. The Main Menu allows you to select from nine setup functions and two exit choices. Use arrow keys to select among the items and press <Enter> to accept or enter the sub-menu.

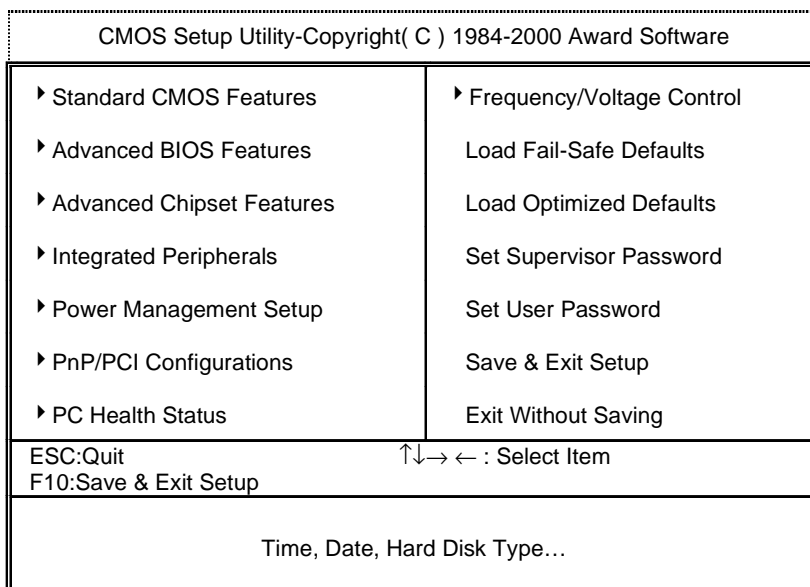

Figure 1: Main Menu

- **Standard CMOS Features**

This setup page includes all the adjustable items in standard compatible BIOS.

- **Advanced BIOS Features**

This setup page includes all the adjustable items of Award special enhanced features.

- **Advanced Chipset Features**

This setup page includes all the adjustable items of chipset special features.

- **Integrated Peripherals**

This setup page includes all onboard peripherals.

- **Power Management Setup**

This setup page includes all the adjustable items of Green function features.

- **PnP/PCI Configurations**

This setup page includes all the adjustable configurations of PCI & PnP ISA resources.

- **PC Health Status**

This setup page is for monitoring system status such as temperature, voltage, and fan speed.

- **Frequency/Voltage Control**

This setup page is for controlling CPU clock and frequency ratio.

- **Load Fail-Safe Defaults**

Load Fail-Safe Defaults option loads preset system parameter values to set the system in its most stable configurations.

- **Load Optimized Defaults**

Load Optimized Defaults option loads preset system parameter values to set the system in its highest performance configurations.

- **Set Supervisor Password**

Set Change or disable password. It allows you to limit access to the system and/or BIOS setup.

- **Set User Password**

Set Change or disable password. It allows you to limit access to the system.

- **Save & Exit Setup**

Save CMOS value settings to CMOS and exit setup.

- **Exit Without Saving**

Abandon all CMOS value changes and exit setup.

Standard CMOS Features

The items in Standard CMOS Setup Menu (Figure 2) are divided into 9 categories. Each category includes none, one or more than one setup items. Use the arrows to highlight the item and then use the <PgUp> or <PgDn> keys to select the value in each item.

CMOS Setup Utility-Copyright(C) 1984-2000 Award Software Standard CMOS Features		
Date (mm:dd:yy)	Wed , Feb 28 2001	Item Help
Time (hh:mm:ss)	2 : 31 : 24	
▶ IDE Primary Master	None	Menu Level ▶
▶ IDE Primary Slave	None	Change the
▶ IDE Secondary Master	None	Day, month,
▶ IDE Secondary Slave	None	Year and
		century
Drive A	1.44M, 3.5 in.	
Drive B	None	
Floppy 3 Mode Support	Disabled	
Video	EGA / VGA	
Halt On	All, But Keyboard	
Base Memory Size	640K	
Extended Memory Size	63488K	
Total Memory	64512K	

↑↓←→:Move Enter:Select +/-/PU/PD:Value F10:Save ESC:Exit F1:General Help
F5:Previous Values F6:Fail-Safe Defaults F7:Optimized Defaults

Figure 2: Standard CMOS Features

- **Date**

The date format is <week>, <month> <day> <year>.

Week	The week, from Sun to Sat, determined by the BIOS and is display-only
Month	The month, Jan. Through Dec.
Day	The day, from 1 to 31 (or the maximum allowed in the month)
Year	The year, from 1994 through 2079

- **Time**

The times format in <hour> <minute> <second>. The time is calculated based on the 24-hour military-time clock. For example, 1 p.m. is 13:00:00.

- **IDE Primary Master / Slave, Secondary Master / Slave**

The category identifies the type of hard disk from drive C to F that has been installed in the computer. There are two settings: Auto, and Manual. Manual: HDD type is user-definable; Auto will automatically detect HDD type.

Note that the specifications of your drive must match with the drive table. The hard disk will not work properly if you enter improper information for this category.

If you select User Type, related information will be asked to enter to the following items. Enter the information directly from the keyboard and press <Enter>. Such information should be provided in the documentation from your hard disk vendor or the system manufacturer.

CYLS.	Number of cylinders
HEADS	number of heads
PRECOMP	write precomp
LANDZONE	Landing zone
SECTORS	number of sectors

If a hard disk has not been installed select NONE and press <Enter>.

- **Drive A / Drive B**

The category identifies the type of floppy disk drive A or drive B that has been installed in the computer.

None	No floppy drive installed
360K, 5.25 in.	5.25 inch PC-type standard drive; 360K byte capacity.
1.2M, 5.25 in.	5.25 inch AT-type high-density drive; 1.2M byte capacity (3.5 inch when 3 Mode is Enabled).
720K, 3.5 in.	3.5 inch double-sided drive; 720K byte capacity
1.44M, 3.5 in.	3.5 inch double-sided drive; 1.44M byte capacity.
2.88M, 3.5 in.	3.5 inch double-sided drive; 2.88M byte capacity.

- **Floppy 3 Mode Support (for Japan Area)**

Disabled	Normal Floppy Drive. (Default value)
Drive A	Drive A is 3 mode Floppy Drive.
Drive B	Drive B is 3 mode Floppy Drive.
Both	Drive A & B are 3 mode Floppy Drives.

- **Video**

The category detects the type of adapter used for the primary system monitor, which must match your video display card and monitor. Although secondary monitors are supported, you do not have to select the type in setup.

EGA/VGA	Enhanced Graphics Adapter/Video Graphics Array. For EGA, VGA, SVGA, or VGA monitor adapters
CGA 40	Color Graphics Adapter, power up in 40 column mode
CGA 80	Color Graphics Adapter, power up in 80 column mode
MONO	Monochrome adapter, includes high resolution monochrome adapters

- **Halt on**

The category determines whether the computer will stop if an error is detected during power up.

NO Errors	The system boot will not stop for any error that may be detected.
All Errors	The system boot will stop on any error detected.
All, But Keyboard	The system boot will not stop for a keyboard error; it will stop for all other errors. (Default value)
All, But Diskette	The system boot will not stop for a disk error; it will stop for all other errors.
All, But Disk/Key	The system boot will not stop for a keyboard or disk error; it will stop for all other errors.

- **Memory**

The category is display-only which is determined by POST (Power On Self Test) of the BIOS.

Base Memory Size

The POST of the BIOS will determine the amount of base (or conventional) memory installed in the system.

640 K for systems with 640 K or more memory installed on the motherboard.

Extended Memory Size

The BIOS determines how much extended memory is present during the POST.

This is the amount of memory located above 1 MB in the CPU's memory address map.

Advanced BIOS Features

CMOS Setup Utility-Copyright(C) 1984-2000 Award Software Advanced BIOS Features		
Virus Warning	Disabled	Item Help
First Boot Device	Floppy	
Second Boot Device	IDE-0	Menu Level ▶
Third Boot Device	CDROM	Allows you to
× RAID/SCSI Boot Order	RAID, SCSI	choose the VIRUS
Floppy Drive Seek	Disabled	Warning feature
BootUp Num-Lock	On	For IDE Hard disk
Password Check	Setup	Boot sector
HDD S.M.A.R.T Capability	Disabled	Protection. If this
		Function is enable
		And someone
		Attempt to write
		Data into this area
		, BIOS will show
		A warning
		Message on
		Screen and alarm
		beep

↑↓→←:Move Enter:Select +/-/PU/PD:Value F10:Save ESC:Exit F1:General Help
F5:Previous Values F6:Fail-Safe Defaults F7:Optimized Defaults

Figure 3: Advanced BIOS Features

× This item will be available when " First / Second / Third Boot device" is set to SCSI/RAID.

● Virus Warning

If it is set to enable, a warning will be displayed on the screen when there is any attempt to write to the boot sector or partition table of the hard disk drive. The system will halt and the following error message will appear in the mean time. You can run anti-virus program to locate the problem.

Enabled	Activates virus protection and displays a warning message whenever anything attempts to write to the boot sector or the hard disk partition table.
Disabled	No warning message appears when anything attempts to write to the boot sector or hard disk partition table. (Default value)

● First / Second / Third Boot Device

Floppy	Set your boot device priority to Floppy.
LS120	Set your boot device priority to LS120.

IDE-0~3	Set your boot device priority to IDE-0~3.
SCSI/RAID	Set your boot device priority to SCSI/RAID.
CDROM	Set your boot device priority to CDROM.
ZIP	Set your boot device priority to ZIP.
Disabled	Disable this function.
LAN	Set your boot device priority to LAN.

- **RAID/SCSI Boot Order**

RAID, SCSI	Select Boot first from RAID/ATA100 device on board. (Default value)
SCSI, RAID	Select Boot first from SCSI device on the add-on PCI SCSI card.

- **Floppy Drive Seek**

During POST, BIOS will determine if the floppy disk drive installed is 40 or 80 tracks. 360 type is 40 tracks while 720, 1.2 and 1.44 are all 80 tracks.

Enabled	BIOS searches for floppy disk drive to determine if it is 40 or 80 tracks. Note that BIOS can't differentiate between from 720, 1.2 or 1.44 drive type as they are all 80 tracks.
Disabled	BIOS will not search for the type of floppy disk drive by track number. Note that there will not be any warning message if the drive installed is 360. (Default Value)

- **BootUp Num-Lock**

On	Keypad is number keys. (Default value)
Off	Keypad is arrow keys.

- **Password Check**

 Please refer to the detail on P.116.

System	The user must enter correct password in order to access the system and/or BIOS Setup.
Setup	The user must enter correct password in order to access BIOS setup utility. (Default Value)

- **HDD S.M.A.R.T. Capability**

Enabled	Enable HDD S.M.A.R.T. Capability.
Disabled	Disable HDD S.M.A.R.T. Capability. (Default value)

Advanced Chipset Features

CMOS Setup Utility-Copyright(C) 1984-2000 Award Software Advanced Chipset Features		
Top Performance	Disabled	Item Help
AGP Aperture Size	64	Menu Level ▶
AGP Fast Write	Enabled	
AGP Mode	4X	
AGP Always Compensate	Enabled	
SDRAM ECC Setting	Disabled	
DRAM Timing setting by	Auto	
X DRAM PH Limit	8 Cycle	
X DRAM Idle Limit	8 Cycle	
X DRAM Trc Timing Value	7 Cycle	
X DRAM Trp Timing Value	2 Cycle	
X DRAM Tras Timing Value	5 Cycle	
X DRAM CAS Latency	2 Cycle	
X SDRAM Trcd Timing Value	2 Cycle	

↑↓ → ←: Move Enter: Select +/-/PU/PD: Value F10: Save ESC: Exit F1: General Help
F5: Previous Values F6: Fail-Safe Defaults F7: Optimized Defaults

Figure 4: Advanced Chipset Features

- **Top Performance**

If you wish to maximize the performance of your system, set "Top Performance" as "Enabled".

Disabled	Top Performance Disable. (Default Value)
Enabled	Top Performance Enable.

- **AGP Aperture Size**

32MB	Display AGP Aperture Size is 32.
64MB	Display AGP Aperture Size is 6MB. (Default Value)
128MB	Display AGP Aperture Size is 128
256MB	Display AGP Aperture Size is 256

- **AGP Fast Write**

Enabled	Enable this function only if the AGP Card support Fast Write Function. (Enable this function can increase AGP performance). (Default Value)
Disabled	Disable this function.

- **AGP Mode**

4X	Set AGP Mode to 4X (Only if the AGP Card support 4X Rate). (Default Value)
1X/2X	Set AGP Mode to 1X/2X.

- **AGP Always Compensate**

Enabled	Enable AGP Always Compensate function. (Default Value)
Disabled	Disable this function.

- **SDRAM ECC Setting**

Disabled	Disable DRAM ECC Setting function. (Default Value)
Check Only	Set DRAM ECC Setting to Check Only. Enable DRAM error checking function.
Correct Error	Set DRAM ECC Setting to Correct Errors. Enable DRAM 1 bit error checking and correcting in CPU/AGP/PCI.
Correct + Scrub	Set DRAM ECC Setting to Correct+Scrub. Enable DRAM 1bit error checking and correcting in CPU/AGP/PCI and DRAM.

- **DRAM Timing setting by**

Auto	Set DRAM Timing setting to Auto. (Default value)
Manual	Set DRAM Timing setting to Manual.

- **DRAM PH Limit**

This function specify the number of consecutive Page-Hit requests to allow before choosing a non-Page-Hit request.

1 Cycle	Set DRAM PH Limit to 1 Cycle.
4 Cycle	Set DRAM PH Limit to 4 Cycle.
8 Cycle	Set DRAM PH Limit to 8 Cycle.
16 Cycle	Set DRAM PH Limit to 16 Cycle.

- **DRAM Idle Limit**

This function specify the number of idle cycles to wait before precharging an idle bank. (Idle cycles are defined as cycles where no valid request is asserted to the MCT.)

0 Cycle	Set DRAM Idle Limit to 0 Cycle.
8 Cycle	Set DRAM Idle Limit to 8 Cycle.
12 Cycle	Set DRAM Idle Limit to 12 Cycle.

16 Cycle	Set DRAM Idle Limit to 16 Cycle.
24 Cycle	Set DRAM Idle Limit to 24 Cycle.
32 Cycle	Set DRAM Idle Limit to 32 Cycle.
48 Cycle	Set DRAM Idle Limit to 48 Cycle.
Disabled	Disable this function.

- **DRAM Trc Timing Value**

This function specify the minimum time from activate to activate of the same bank.

3 Cycle	Set DRAM Trc Timing Value to 3 Cycle.
4 Cycle	Set DRAM Trc Timing Value to 4 Cycle.
5 Cycle	Set DRAM Trc Timing Value to 5 Cycle.
6 Cycle	Set DRAM Trc Timing Value to 6 Cycle.
7 Cycle	Set DRAM Trc Timing Value to 7 Cycle.
8 Cycle	Set DRAM Trc Timing Value to 8 Cycle.
9 Cycle	Set DRAM Trc Timing Value to 9 Cycle.
10 Cycle	Set DRAM Trc Timing Value to 10 Cycle.

- **DRAM Trp Timing Value**

This function specify the delay from precharge command to activate command.

1 Cycle	Set DRAM Trp Timing Value to 1 Cycle.
2 Cycle	Set DRAM Trp Timing Value to 2 Cycle.
3 Cycle	Set DRAM Trp Timing Value to 3 Cycle.
4 Cycle	Set DRAM Trp Timing Value to 4 Cycle.

- **DRAM Tras Timing Value**

This function specifies the minimum bank (active time: time from active to precharge of same bank).

2 Cycle	Set DRAM Tras Timing Value to 2 Cycle.
3 Cycle	Set DRAM Tras Timing Value to 3 Cycle.
4 Cycle	Set DRAM Tras Timing Value to 4 Cycle.
5 Cycle	Set DRAM Tras Timing Value to 5 Cycle.
6 Cycle	Set DRAM Tras Timing Value to 6 Cycle.
7 Cycle	Set DRAM Tras Timing Value to 7 Cycle.
8 Cycle	Set DRAM Tras Timing Value to 8 Cycle.
9 Cycle	Set DRAM Tras Timing Value to 9 Cycle.

- **DRAM CAS Latency**

This function specify the DRAM CAS Latency.

2 Cycle	Set DRAM CAS Latency to 2 Cycle.
2.5 Cycle	Set DRAM CAS Latency to 2.5 Cycle.

- **SDRAM Trcd Timing Value**

This function specifies the delay from the activation of a bank to the time that a read or write command is accepted.

1 Cycle	Set SDRAM Trcd Timing Value to 1 Cycle.
2 Cycle	Set SDRAM Trcd Timing Value to 2 Cycle.
3 Cycle	Set SDRAM Trcd Timing Value to 3 Cycle.
4 Cycle	Set SDRAM Trcd Timing Value to 4 Cycle.

Integrated Peripherals

CMOS Setup Utility-Copyright(C) 1984-2000 Award Software Integrated Peripherals		
OnBoard IDE1	Enabled	Item Help
OnBoard IDE2	Enabled	
VGA Boot from	AGP	Menu Level ▶
◆ OnBoard Sound Chip	Enabled	
BIOS Flash Protection	Disabled	
USB Controller 1	Enabled	
USB Controller 2	Enabled	
USB Legacy Support	Disabled	
AC97 Audio	Auto	
AC97 Modem	Auto	
Onboard FDD Controller	Enabled	
Onboard Serial Port 1	Auto	
Onboard Serial Port 2	Auto	
UART 2 Mode	Standard	
※ IR Function Duplex	Half	
※ TX, RX inverting enable	No, Yes	
Onboard Parallel Port	378/IRQ7	
Onboard Parallel Mode	Normal	
※ ECP Mode Use DMA	3	
※ Parallel Port EPP Type	EPP1.9	
♣ Sound Blaster	Disabled	
♣ SB I/O Base Address	220H	
♣ SB IRQ Select	IRQ 5	
♣ SB DMA Select	DMA 1	
♣ MPU-401	Disabled	
♣ MPU-401 I/O Address	330-333H	
♣ Game Port (200-207H)	Enabled	

↑↓←→:Move Enter:Select +/-/PU/PD:Value F10:Save ESC:Exit F1:General Help
F5:Previous Values F6:Fail-Safe Defaults F7:Optimized Defaults

Figure 5: Integrated Peripherals

- ◆ This item will only be shown when there is sound chip onboard.
- ※ These two items will be available when "UART 2 Mode" is set to HPSIR or ASKIR.
- ※ These two items will be available when "Onboard Parallel Mode" is set to ECP/EPP.
- ♣ These seven items will not be shown when there is sound chip onboard.

- **OnBoard IDE1**

Enabled	Enable onboard 1st channel IDE port. (Default value)
Disabled	Disable onboard 1st channel IDE port.

- **OnBoard IDE2**

Enabled	Enable onboard 2nd channel IDE port. (Default value)
Disabled	Disable onboard 2nd channel IDE port.

- **VGA Boot from**

PCI Slot	Set VGA Boot from PCI VGA Card.
AGP	Set VGA Boot from AGP VGA Card. (Default value)

- **Onboard Sound Chip**

Enabled	Enable Onboard Sound Chip function. (Default Value)
Disabled	Disable this function.

- **BIOS Flash Protection**

Enabled	Enable BIOS Flash Protection. This will prevent BIOS Flash write after POST.
Disabled	To flash/upgrade BIOS on this MB, this item must be disable. We recommend this item to be set to "Disabled". (Default Value)

- **USB Controller 1**

Enabled	Enable USB Controller 1. (Default value)
Disabled	Disable USB Controller 1.

- **USB Controller 2**

Enabled	Enable USB Controller 2. (Default value)
Disabled	Disable USB Controller 2.

- **USB Legacy Support**

Enabled	Enable USB Device (Such as USB KB, Mouse) support in Legacy Mode, eg. DOS. Win NT4.0.
Disabled	Disable OnBoard Legacy Audio. (Default Value)

- **AC97 Audio**

Auto	BIOS will search AC97 Codec. If found, AC97 function will be enabled. If no AC97 Codec found, AC97 function will be disabled. (Default Value)
Disabled	Disable this function.

- **AC97 Modem**

Auto	BIOS will search MC97 Codec (AMR Modem Card). If found, MC97 function will be enabled. If no MC97 Codec found, MC97 function will be disabled. (Default Value)
Disabled	Disable this function.

- **Onboard FDD Controller**

Enabled	Enable on board floppy disk controller. (Default value)
Disabled	Disable this function.

- **Onboard Serial Port 1**

Auto	BIOS will automatically setup the port 1 address. (Default value)
3F8/IRQ4	Enable onboard Serial port 1 and address is 3F8.
2F8/IRQ3	Enable onboard Serial port 1 and address is 2F8.
3E8/IRQ4	Enable onboard Serial port 1 and address is 3E8.
2E8/IRQ3	Enable onboard Serial port 1 and address is 2E8.
Disabled	Disable onboard Serial port 1.

- **Onboard Serial Port 2**

Auto	BIOS will automatically setup the port 2 address. (Default Value)
3F8/IRQ4	Enable onboard Serial port 2 and address is 3F8.
2F8/IRQ3	Enable onboard Serial port 2 and address is 2F8.
3E8/IRQ4	Enable onboard Serial port 2 and address is 3E8.
2E8/IRQ3	Enable onboard Serial port 2 and address is 2E8.
Disabled	Disable onboard Serial port 2.

- **UART 2 Mode**

(This item allows you to determine which UART 2 Mode of onboard I/O chip)

Standard	Normal UART 2 operation. (Default Value)
HPSIR	Set onboard I/O chip UART 2 to HPSIR Mode.
ASKIR	Set onboard I/O chip UART 2 to ASKIR Mode.

- **IR Function Duplex**

Half	Half Duplex IR function. (Default Value)
Full	Full Duplex IR function.

- **TX, RX inverting enable**

No, No	Set TX, RX inverting enable to No, No.
No, Yes	Set TX, RX inverting enable to No, Yes. (Default value)
Yes, No	Set TX, RX inverting enable to Yes, No.
Yes, Yes	Set TX, RX inverting enable to Yes, Yes.

- **Onboard Parallel Port**

378/IRQ7	Enable onboard LPT port and address is 378/IRQ7. (Default Value)
278/IRQ5	Enable onboard LPT port and address is 278/IRQ5.
Disabled	Disable onboard LPT port.
3BC/IRQ7	Enable onboard LPT port and address is 3BC/IRQ7.

- **Onboard Parallel Mode**

Normal	Normal Operation. (Default value)
EPP	Using Parallel port as Enhanced Parallel Port.
ECP	Using Parallel port as Extended Capabilities Port.
ECP/EPP	Using Parallel port as ECP & EPP mode.

- **ECP Mode Use DMA**

3	Set ECP Mode Use DMA to 3. (Default Value)
1	Set ECP Mode Use DMA to 1.

- **Parallel Port EPP Type**

EPP 1.9	Set Parallel Port EPP Type to EPP 1.9. (Default value)
EPP 1.7	Set Parallel Port EPP Type to EPP 1.7.

- **Sound Blaster**

Enabled	Enable Sound Blaster.
Disabled	Disable Sound Blaster. (Default Value)

- **SB I/O Base Address**

220H	Set SB I/O Base Address to 220H. (Default Value)
240H	Set SB I/O Base Address to 240H.
260H	Set SB I/O Base Address to 260H.
280H	Set SB I/O Base Address to 280H.

- **SB IRQ Select**

IRQ 5 / 10. (Default Value: 5)

- **SB DMA Select**

DMA 0 / 1 / 2 / 3. (Default Value: 1)

- **MPU-401**

Enabled	Enable MPU-401.
Disabled	Disable MPU-401. (Default Value)

Ps. When Force Feedback joystick is used, MPU-401 needs to be Enable.

- **MPU-401 I/O Address**

330-333H	Set MPU-401 I/O Address to 330-333H. (Default Value)
300-303H	Set MPU-401 I/O Address to 300-303H.
310-313H	Set MPU-401 I/O Address to 310-313H.
320-323H	Set MPU-401 I/O Address to 320-323H.

- **Game Port (200-207H)**

Disabled	Disable Game Port (200-207H).
Enabled	Enable Game Port (200-207H). (Default Value)

Power Management Setup

CMOS Setup Utility-Copyright(C) 1984-2000 Award Software Power Management Setup		
ACPI Sleep Type	S1(POS)	Item Help
Suspend Time Out (Minute)	Disabled	Menu Level ▶
Soft-Off by PBTN	Instant-off	
System after AC Back	Off	
PME Event Wake Up	Enabled	
USB Dev Wakeup from S3-S5	Disabled	
ModemRingOn/WakeOnLan	Enabled	
MODEM Use IRQ	3	
Resume by RTC Alarm	Disabled	
X Date (of Month) Alarm	0	
X Time (hh:mm:ss) Alarm	0 0 0	
▶IRQ Wakeup Events	Press Enter	
VGA	OFF	
LPT & COM	LPT/COM	
HDD & FDD	ON	
PCI master	OFF	
↑↓→←:Move Enter:Select +/-/PU/PD:Value F10:Save ESC:Exit F1:General Help F5:Previous Values F6:Fail-Safe Defaults F7:Optimized Defaults		

Figure 6: Power Management Setup

- **ACPI Sleep Type**

S1 (POS)	Set ACPI Sleep Type to S1 (Power On Suspend). (Default value)
S3 (STR)	Set ACPI Sleep Type to S3 (Suspend to RAM).

- **Suspend Time Out (Minute)**

Disabled	Disable Suspend Time Out Function. (Default Value)
30 Sec - 1 Hour	Set the timer to enter Suspend Time Out.

- **Soft-off by PBTN**

Instant-off	The user press the power button once, he can turn off the system. (Default Value)
Suspend	The user press the power button once, then he can enter suspend mode.

- **System After AC Back**

Last State	When AC-power back to the system, the system will return to the Last state before AC-power off.
Off	When AC-power back to the system, the system will be in "Off" state. (Default Value)
On	When AC-power back to the system, the system will be in "On" state.

- **PME Event Wake Up**

Disabled	Disable PME event wake up function.
Enabled	The PME event wake up will bring the system out of soft-off or suspend state if this option is set "Enabled". (Default Value)

- **USB Dev Wakeup from S3-S5**

Enabled	Enable USB Device Wakeup from ACPI S3, S4 and S5 mode.
Disabled	Disable USB Device Wakeup from ACPI S3, S4 and S5 mode. (Default Value)

- **ModemRingOn/WakeOnLan**

Disabled	Disable Modem Ring On / Wake On LAN function.
Enabled	The modem ring / LAN wake up will bring the system out of soft-off or suspend state if this option is set "Enabled". (Default Value)

- **MODEM Use IRQ**

NA	Set MODEM Use IRQ to NA.
3	Set MODEM Use IRQ to 3. (Default value)
4	Set MODEM Use IRQ to 4.
5	Set MODEM Use IRQ to 5.
7	Set MODEM Use IRQ to 7.
9	Set MODEM Use IRQ to 9.
10	Set MODEM Use IRQ to 10.
11	Set MODEM Use IRQ to 11.

- **Resume by RTC Alarm**

You can set "Resume by RTC Alarm" item to Enabled and key in date/time to power on system.

Disabled	Disable this function. (Default value)
Enabled	Enable alarm function to POWER ON system or wake up system from sleep mode.

If the default value is Enabled.

Date (of Month) Alarm :	0-31
Time (hh: mm: ss) Alarm :	(0-23) : (0-59) : (0-59)

- **IRQs Activity**

Disabled	Disable this function.
Primary	The resource is used by Primary device. (Default value)
Secondary	The resource is used by Secondary device.

- **IRQ [3-15]**

Disabled	Disable specified IRQ to Wake up system from sleep mode or Reload PM Timer to prevent system to enter sleep mode.
Enabled	Enable specified IRQ to Wake up system from sleep mode or Reload PM Timer to prevent system to enter sleep mode.

- **VGA**

OFF	Disable monitor VGA activity to prevent system to enter sleep mode. (Default value)
ON	Enable monitor VGA activity to prevent system to enter sleep mode.

- **LPT & COM**

LPT/COM	Enable LPT/COM Ports Activity to Wake up system from sleep mode or prevent system to enter sleep mode. (Default value)
NONE	Normal Operation.
LPT	Enable LPT Ports Activity to Wake up system from sleep mode or prevent system to enter sleep mode.
COM	Enable COM Ports Activity to Wake up system from sleep mode or prevent system to enter sleep mode.

- **HDD & FDD**

ON	Enable HDD & FDD Ports Activity to Wake up system from sleep mode or prevent system to enter sleep mode. (Default value)
OFF	Disable HDD & FDD Ports Activity to Wake up system from sleep mode or prevent system to enter sleep mode.

- **PCI master**

ON	Enable PCI master Activity to Wake up system from sleep mode or prevent system to enter sleep mode.
OFF	Disable PCI master Activity to Wake up system from sleep mode or prevent system to enter sleep mode. (Default value)

PnP/PCI Configurations

CMOS Setup Utility-Copyright(C) 1984-2000 Award Software PnP/PCI Configurations		
Reset Configuration Data	Disabled	Item Help
Resources Controlled By	Auto (ESCD)	Menu Level ▶
X IRQ Resources	Press Enter	
INT A Assignment	Auto	Default is Disabled.
INT B Assignment	Auto	Select Enabled to
INT C Assignment	Auto	reset Extended System
INT D Assignment	Auto	Configuration Data
		ESCD) when you exit
		Setup if you have
		installed a new add-on
		and the System
		reconfiguration has
		caused such a serious
		conflict that the OS
		cannot boot
↑↓ → ← Move Enter:Select +/-PU/PD:Value F10:Save ESC:Exit F1:General Help F5:Previous Values F6:Fail-Safe Defaults F7:Optimized Defaults		

Figure 7: PnP/PCI Configurations

- Reset Configuration Data**

Advising BIOS clear PnP configuration data for usable value.

Disabled	Disable this function. (Default value)
Enabled	Reset PnP configuration data in order to re-initialize ESCD for PnP device.

- Resources Controlled by**

Manual	User can set the PnP resource (I/O Address, IRQ & DMA channels) used by legacy ISA DEVICE.
Auto(ESCD)	BIOS automatically use these PnP rescuers. (Default value)

- IRQ (3, 4, 5, 7, 9, 10, 11, 12, 14, 15)**

PCI Device	The resource is used by PCI device. (Default value)
Reserved	Set the resource to reserved.

- INT A / B / C / D Assignment

Auto	Will be automatically detected by BIOS. (Default value)
3	Set INT A / B / C / D Assignment to 3.
4	Set INT A / B / C / D Assignment to 4.
5	Set INT A / B / C / D Assignment to 5.
7	Set INT A / B / C / D Assignment to 7.
9	Set INT A / B / C / D Assignment to 9.
10	Set INT A / B / C / D Assignment to 10.
11	Set INT A / B / C / D Assignment to 11.
12	Set INT A / B / C / D Assignment to 12.
14	Set INT A / B / C / D Assignment to 14.
15	Set INT A / B / C / D Assignment to 15.

PC Health Status

CMOS Setup Utility-Copyright(C) 1984-2000 Award Software		
PC Health Status		
		Item Help
CPU Warning Temperature	Disabled	Menu Level ▶
CPU Fan Warning	No	
System Fan Warning	No	
Current CPU Temp.	57°C/134°F	
Current System Temp.	31°C/87°F	
CPU Fan Speed	5553 RPM	
System Fan Speed	0 RPM	
Vcore	3.10V	
3.3V	3.31V	
5V	5.10V	
12V	12.42V	

↑↓→ ← Move Enter:Select +/-PU/PD:Value F10:Save ESC:Exit F1:General Help
F5:Previous Values F6:Fail-Safe Defaults F7:Optimized Defaults

Figure 8: PC Health Status

- CPU Warning Temperature (°C / °F)

60°C / 140°F	Monitor CPU Temp. at 60°C / 140°F.
70°C / 158°F	Monitor CPU Temp. at 70°C / 158°F.
80°C / 176°F	Monitor CPU Temp. at 80°C / 176°F.
90°C / 194°F	Monitor CPU Temp. at 90°C / 194°F.
Disabled	Disable this function. (Default value)

- CPU Fan Warning

No	Disable this function. (Default value)
Yes	Enable CPU Fan Warning function to display warning message when CPU Fan speed is under lower limit RPM.

- **System Fan Warning**

No	Disable this function. (Default value)
Yes	Enable System Fan Warning function to display warning message when System Fan speed is under a lower limit RPM.

- **Current CPU Temp. (°C / °F)**

Detect CPU Temperature automatically.

- **Current System Temp. (°C / °F)**

Detect System Temperature automatically.

- **CPU Fan / System Fan Speed (RPM)**

Detect Fan speed status automatically.

- **Voltage (V) Vcore / 3.3V / 5V / 12V**

Detect system's voltage status automatically.

Frequency/Voltage Control

CMOS Setup Utility-Copyright(C) 1984-2000 Award Software Frequency/Voltage Control		
CPU Vcore Select	Default	Item Help
CPU Frequency Control	Disabled	Menu Level ▶
CPU Clock	100	

↑↓→←Move Enter:Select +/-PU/PD:Value F10:Save ESC:Exit F1:General Help
F5:Previous Values F6:Fail-Safe Defaults F7:Optimized Defaults

Figure 9: Frequency/Voltage Control

- **CPU Vcore Select**

Supports adjustable CPU voltage from 1.525V to 1.85V by 0.025V step.
(Default value: **Hardware strapping**)

- **CPU Frequency Control**

Disabled	Disable this function. (Default value)
Enabled	Enable this function to setup your CPU clock.

- **CPU Clock**

This item will be available when "CPU Frequency" is set to Enabled.

Load Fail-Safe Defaults

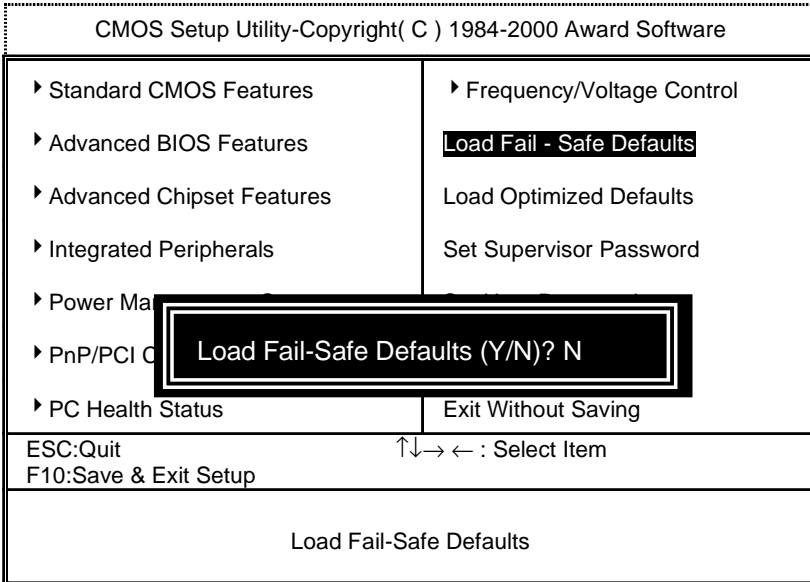

Figure 10: Load Fail-Safe Defaults

- **Load Fail-Safe Defaults**

Fail-Safe defaults contain the most appropriate system parameter values of to configure the system to achieve maximum stability.

Load Optimized Defaults

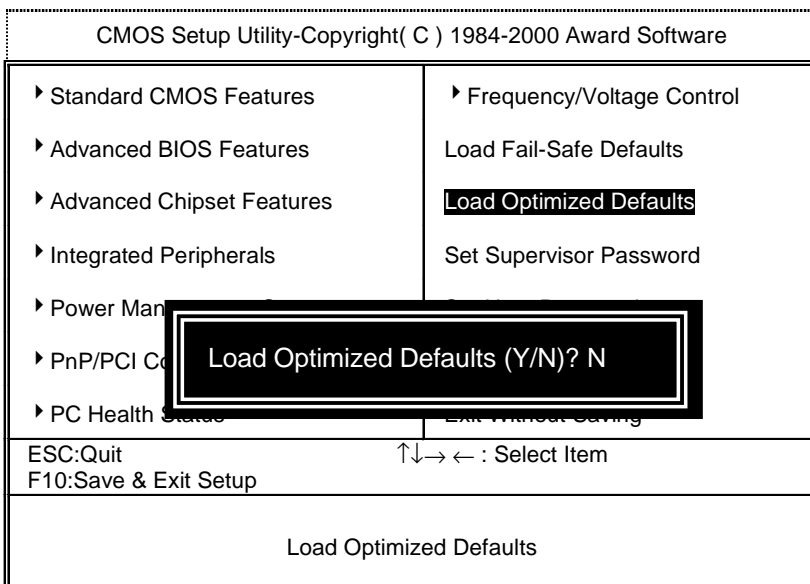

Figure 11: Load Optimized Defaults

- **Load Optimized Defaults**

Optimized defaults contain the most appropriate system parameter values to configure the system to achieve maximum performance.

Set Supervisor / User Password

When you select this function, the following message will appear at the center of the screen to assist you in creating a password.

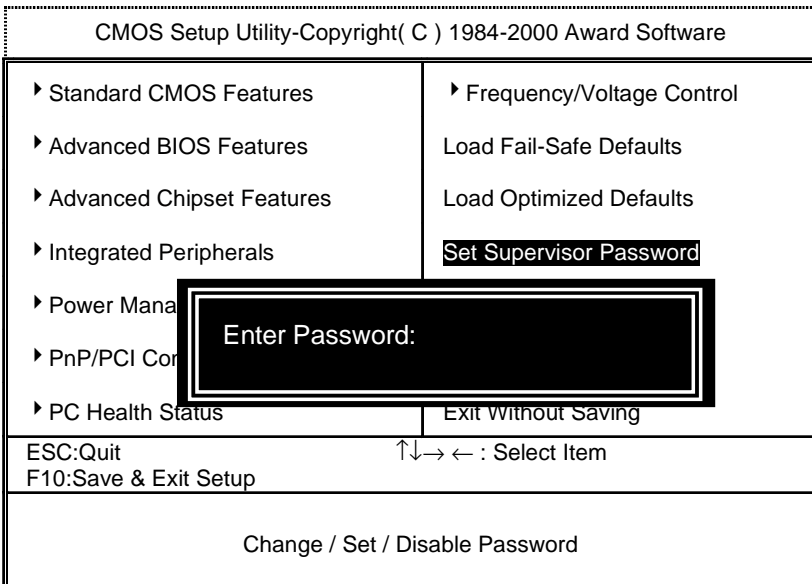

Figure 12: Password Setting

Type the password, up to eight characters, and press <Enter>. You will be asked to confirm the password. Type the password again and press <Enter>. You may also press <Esc> to abort the selection and not enter a password.

To disable password, just press <Enter> when you are prompted to enter password. A message "PASSWORD DISABLED" will appear to confirm the password being disabled. Once the password is disabled, the system will boot and you can enter Setup freely.

The BIOS Setup program allows you to specify two separate passwords: a **SUPERVISOR PASSWORD** and a **USER PASSWORD**. When disabled, anyone may access all BIOS Setup program function. When enabled, the Supervisor password is required for entering the BIOS Setup program and having full configuration fields, the User password is required to access only basic items.

If you select "System" at "Password Check" in Advanced BIOS Feature Menu, you will be prompted for the password every time the system is rebooted or any time you try to enter Setup Menu.

If you select "Setup" at "Password Check" in Advanced BIOS Feature Menu, you will be prompted only when you try to enter Setup.

Exit Without Saving

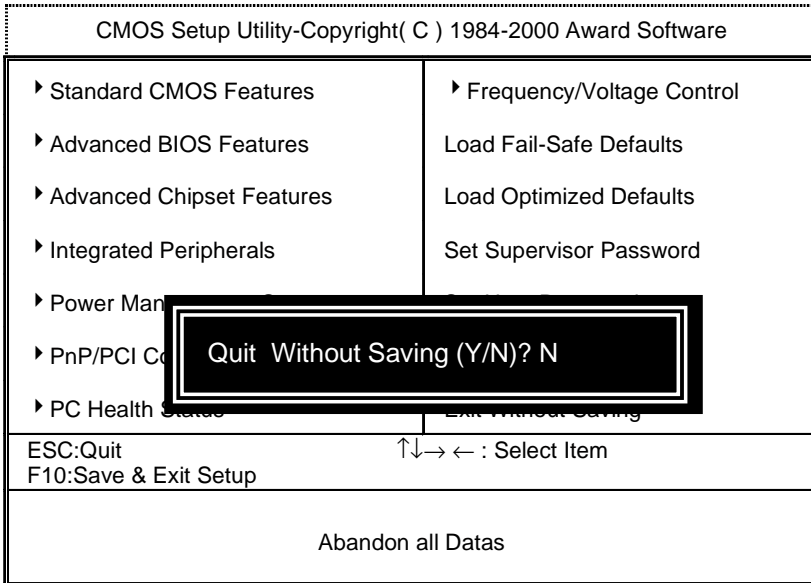

Figure 14: Exit Without Saving

Type "Y" will quit the Setup Utility without saving to RTC CMOS.

Type "N" will return to Setup Utility.



Technical Support / RMA Sheet

Customer/Country:	Company:	Phone No.:
Contact Person:	E-mail Add. :	

Model name/Lot Number:	PCB revision:
BIOS version:	O.S./A.S.:

Hardware Configuration	Mfs.	Model name	Size:	Driver/Utility:
CPU				
Memory Brand				
Video Card				
Audio Card				
HDD				
CD-ROM / DVD-ROM				
Modem				
Network				
AMR / CNR				
Keyboard				
Mouse				
Power supply				
Other Device				

 Problem Description:



Appendix

Appendix A: AMD 761_VIA 686A/B Chipsets Driver Installation

A.AMD AGP Miniport Driver (Win98/SE/ME only):

Insert the support CD that came with your motherboard into your CD-ROM driver or double –click the CD driver icon in My Computer to bring up the screen.



(1)

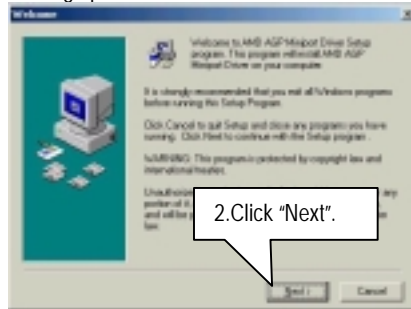

(2)

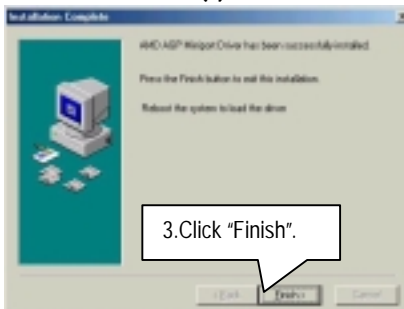

(3)

◆ When the AMD AGP Miniport Driver installation is completed, please restart your computer.

(4)

B: VIA IDE Bus Master Driver Installation

Insert the support CD that came with your motherboard into your CD-ROM drive or double-click the CD drive icon in **My Computer** to bring up the setup screen.

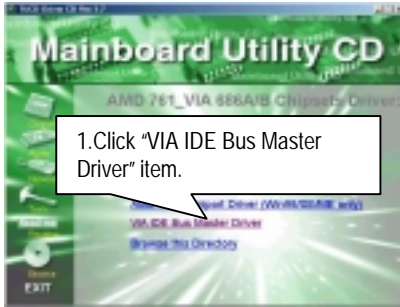

(1)

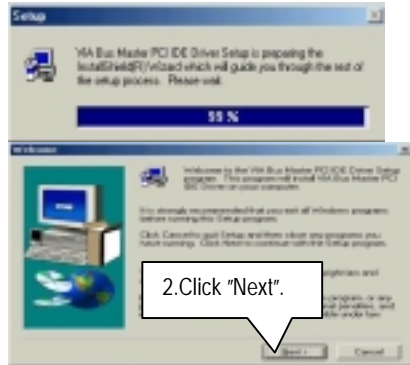

(2)

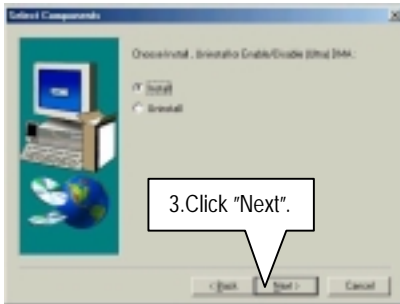

(3)

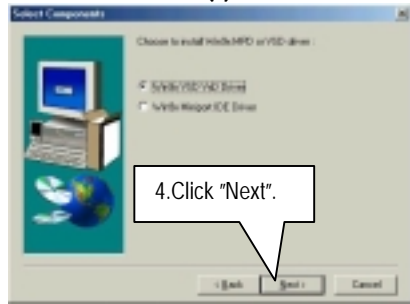

(4)



(5)



(6)

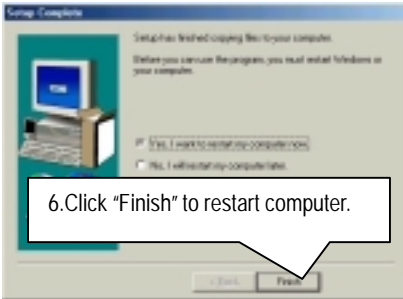

(7)

Appendix B: Promise PCI Device Installation

A. Promise ATA100 Driver Installation:

Insert the support CD that came with your motherboard into your CD-ROM driver or double-click the CD driver icon in My Computer to bring up the screen.

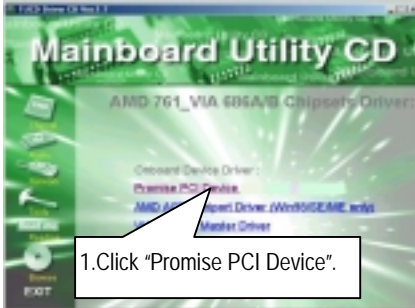

(1)

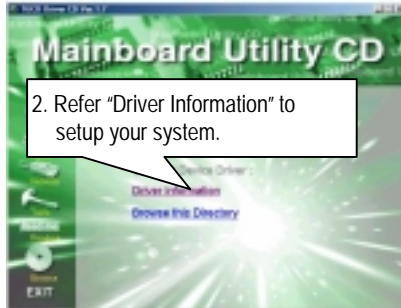

(2)

For your reference, you can use the following steps to complete the Promise ATA100 Driver Installation.

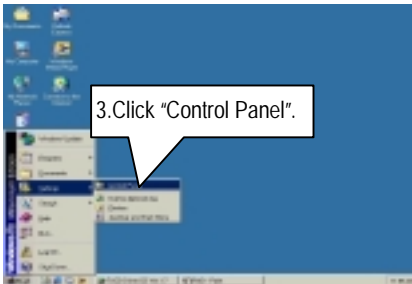

(3)

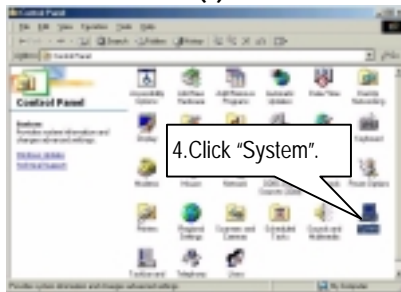

(4)

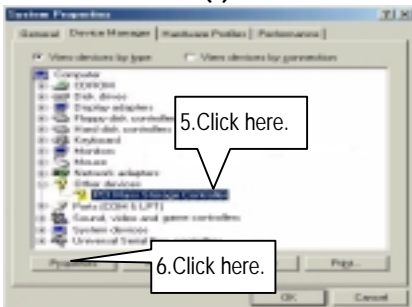

(5)

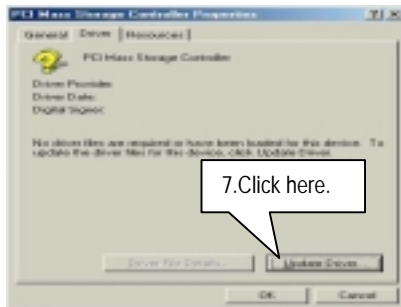

(6)

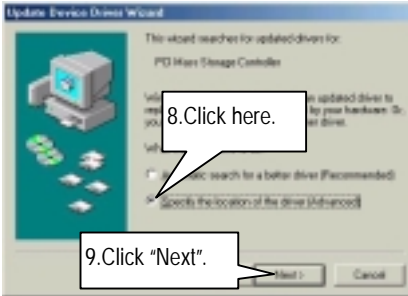

(7)



(8)



(9)

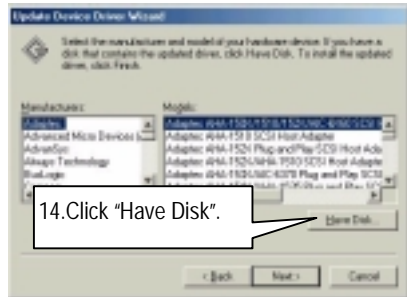

(10)

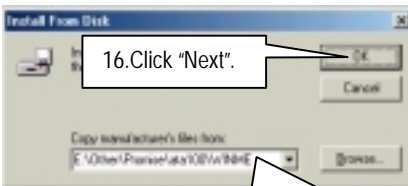

(11)

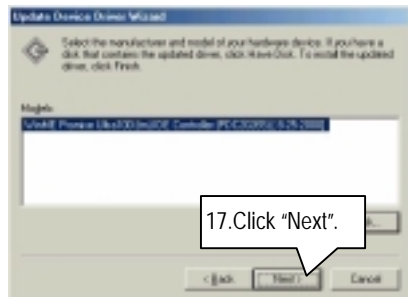

(12)

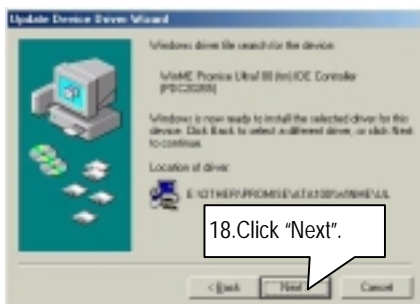

(13)

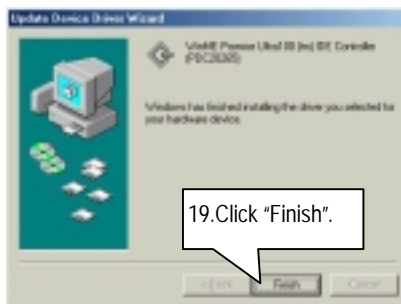

(14)

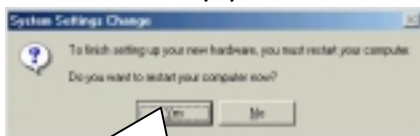

(15)

 If you want to realize the setup information in detail, please refer to the "Driver Information" for setting your system completely.

B. Promise RAID Driver Installation:

Insert the support CD that came with your motherboard into your CD-ROM driver or double-click the CD driver icon in My Computer to bring up the screen.

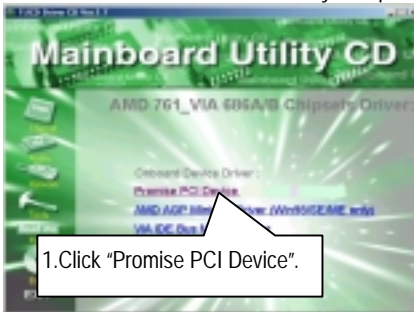

(1)

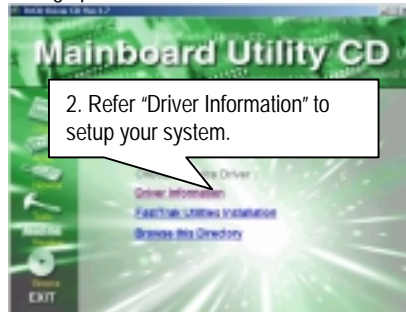

(2)

For your reference, you can use the following steps to complete the Promise RAID Driver Installation.

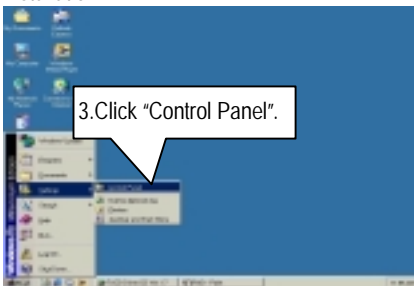

(3)

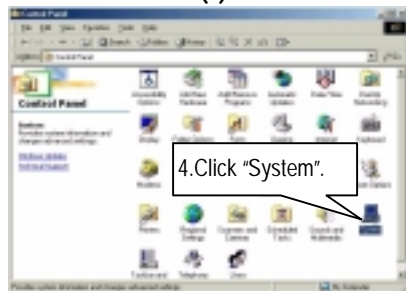

(4)

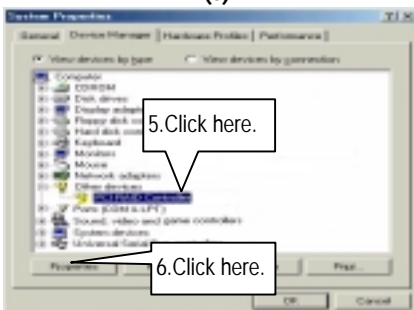

(5)

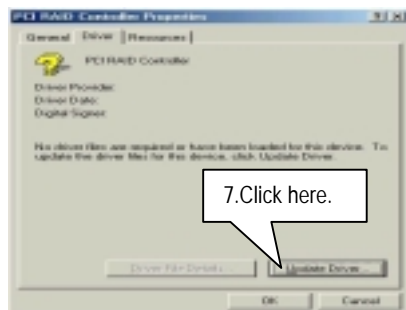

(6)

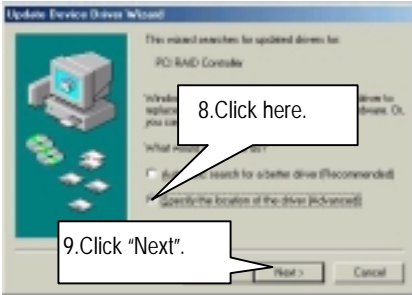

(7)

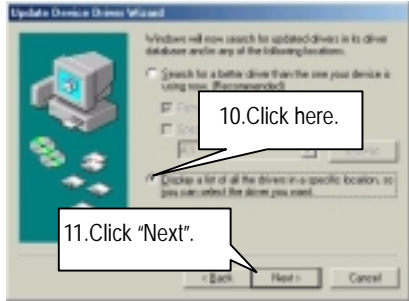

(8)

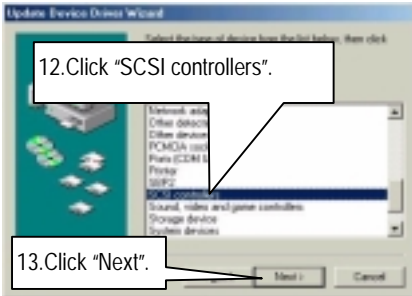

(9)

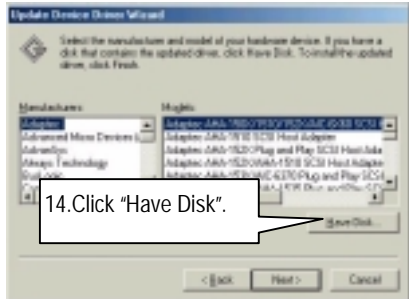

(10)

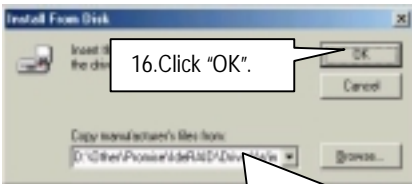

15. Type "D:\Other Promise\IdeRAID\Drivers" (This manual assumes that your CD-ROM device drive letter is D:).

(11)

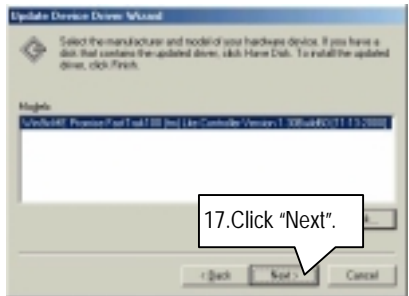

(12)

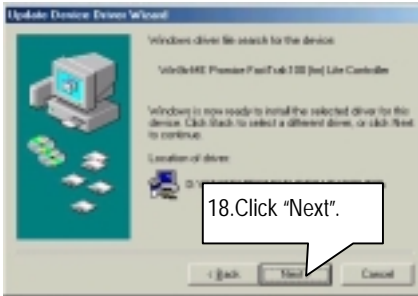

(13)

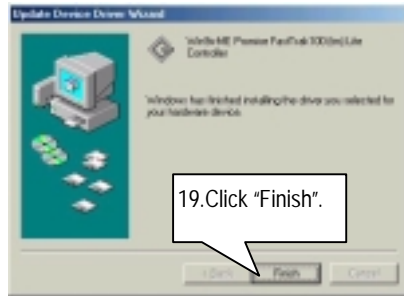

(14)

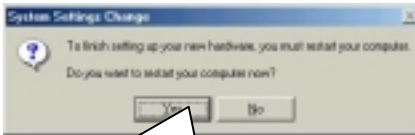

(15)

 If you want to realize the setup information in detail, please refer to the “Driver Information” for setting your system completely.

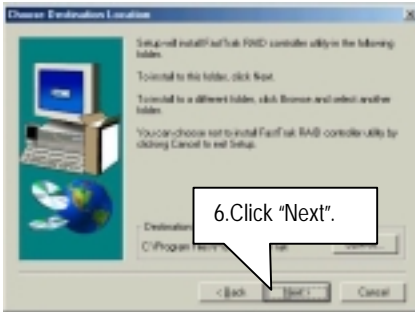

(7)

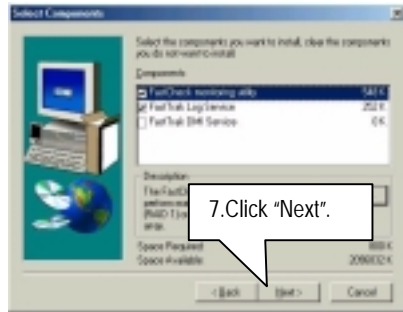

(8)

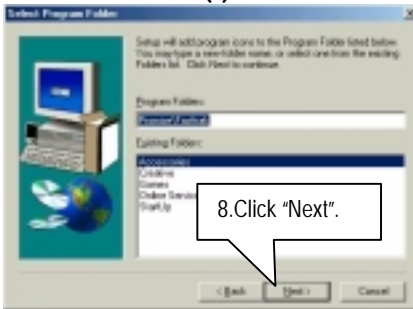

(9)

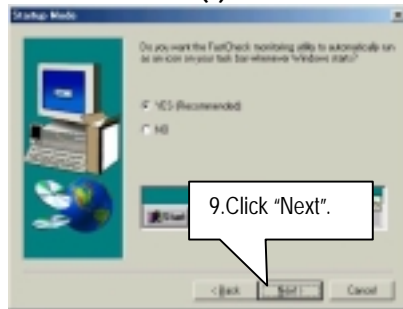

(10)

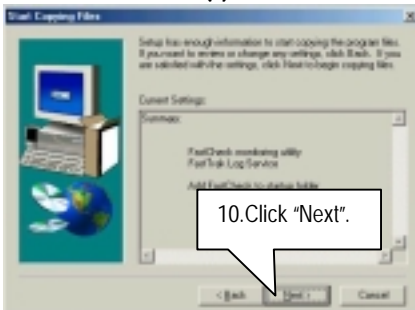

(11)

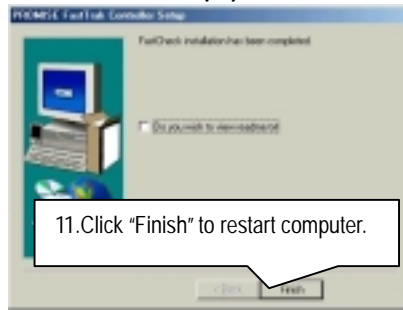

(12)

Appendix C: Creative Sound Driver Installation

Insert the support CD that came with your motherboard into your CD-ROM driver or double-click the CD driver icon in My Computer to bring up the screen.



(1)

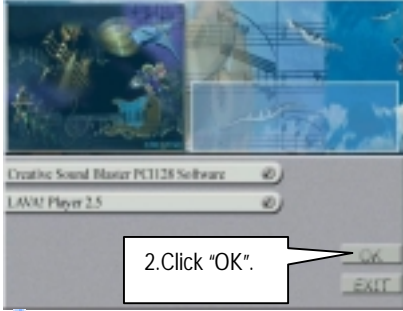

(2)

If "LAVA! Player 2.5" item is selected, it will automatically be installed right after "Creative Sound Blaster PCI128 Software" installation.

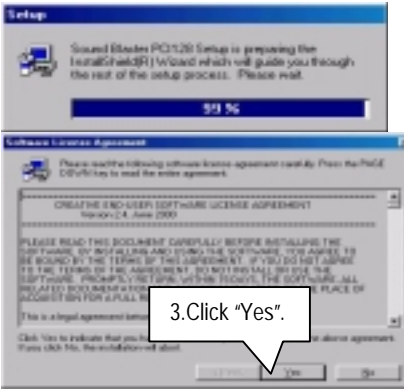

(3)

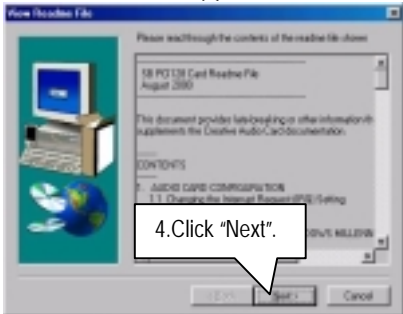

(4)

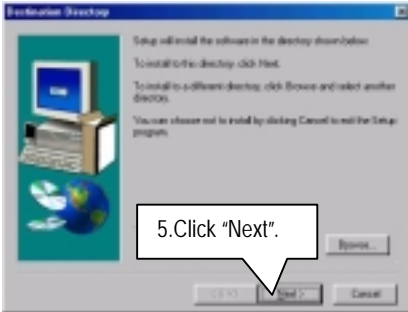

(5)

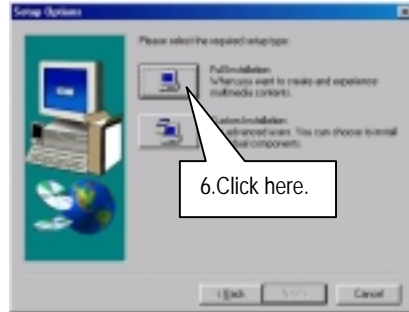

(6)

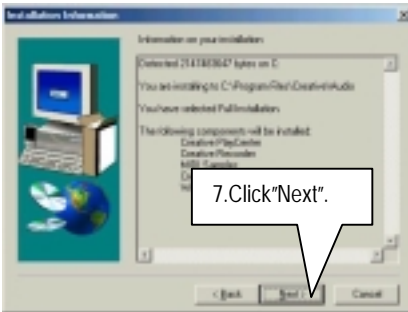

(7)



(8)

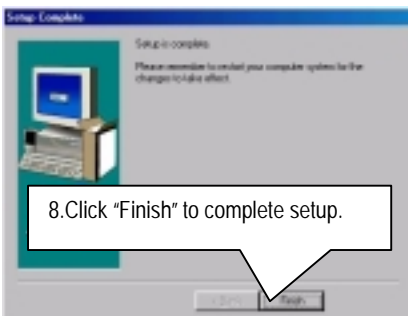

(9)

LAVA! Player Installation:

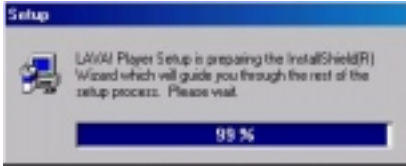

(1)

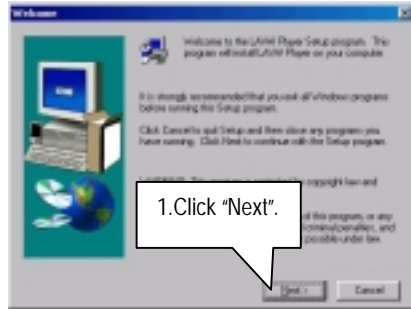

(2)

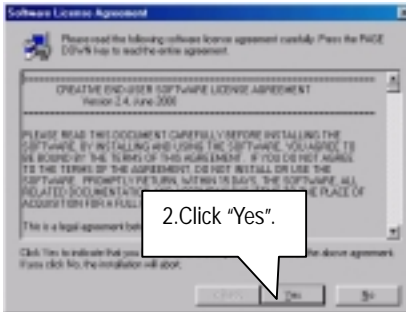

(3)

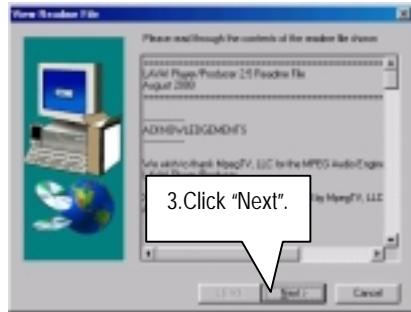

(4)

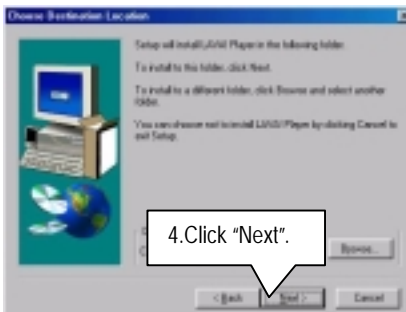

(5)



(6)

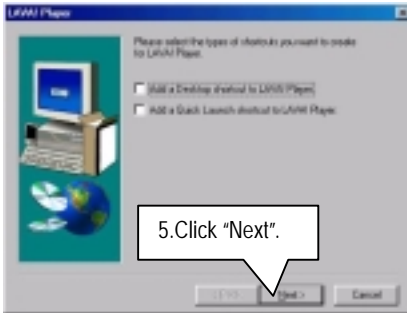

(7)

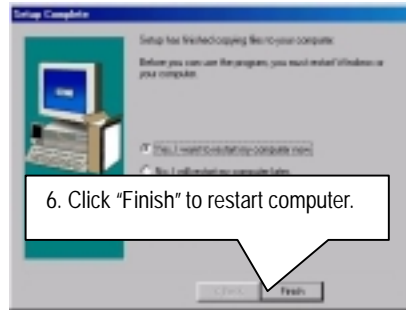

(8)

Appendix D: EasyTuneIII Utilities Installation

Insert the support CD that came with your motherboard into your CD-ROM driver or double-click the CD driver icon in My Computer to bring up the screen.

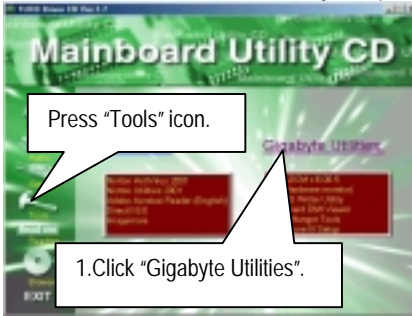

(1)

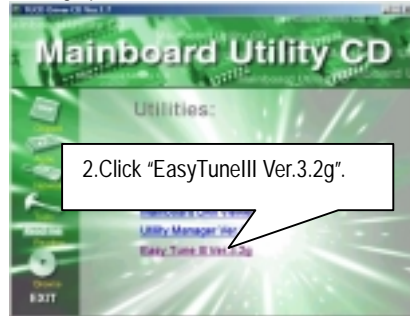

(2)

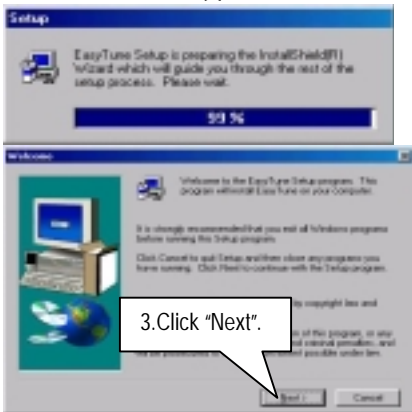

(3)

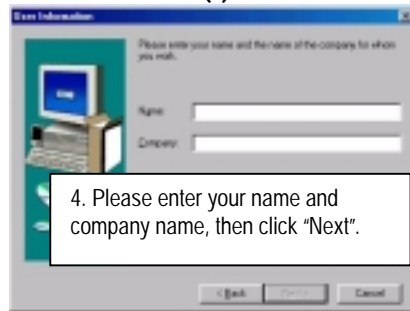

(4)

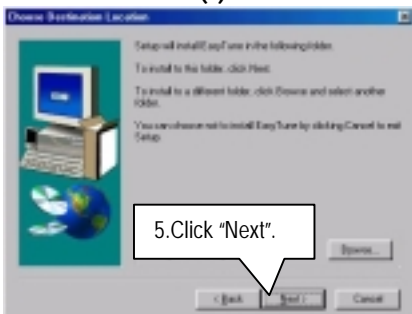

(5)

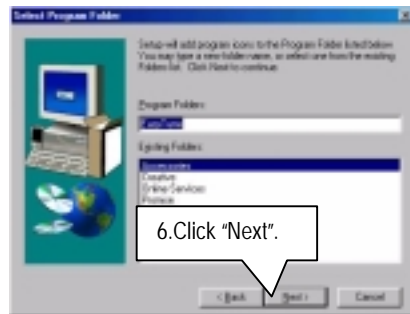

(6)

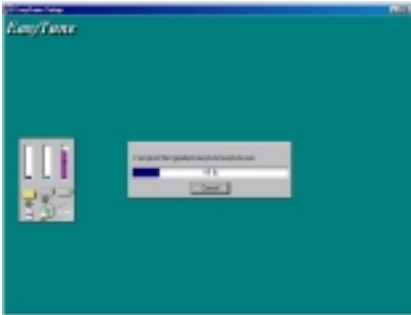

(7)

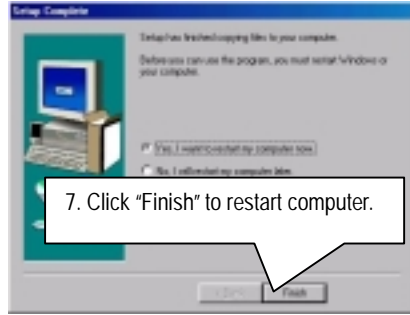

(8)

Appendix E: BIOS Flash Procedure

BIOS update procedure:

If your OS is Win9X, we recommend that you used Gigabyte @BIOS™ Program to flash BIOS.

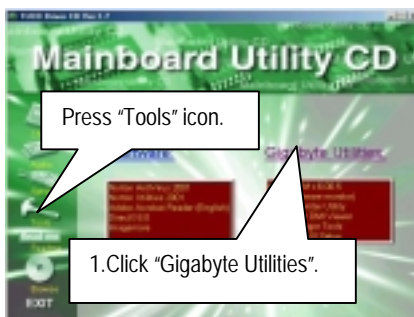

(1)

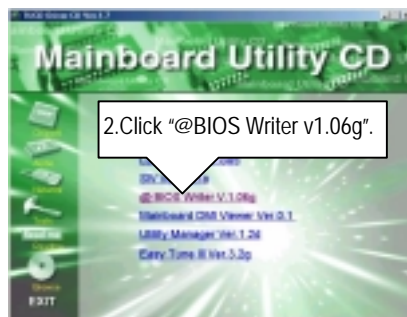

(2)

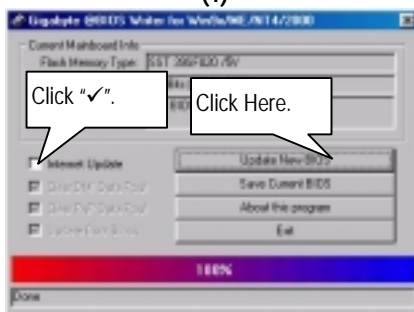

(3)

Methods and steps:

I. Update BIOS through Internet

- a. Click "Internet Update" icon
- b. Click "Update New BIOS" icon
- c. Select @BIOS™ sever ("Gigabyte @BIOS™ sever 1 in Taiwan" and "Gigabyte @BIOS™ sever 2 in Taiwan" are available for now, the others will be completed soon)
- d. Select the exact model name on your motherboard
- e. System will automatically download and update the BIOS.

II. Update BIOS **NOT** through Internet:

- a. **Do not** click "Internet Update" icon
- b. Click "Update New BIOS"
- c. Please select "All Files" in dialog box while opening the old file.
- d. Please search for BIOS unzip file, downloading from internet or any other methods (such as: 7DXR.F1).
- e. Complete update process following the instruction.

III. Save BIOS

In the very beginning, there is "Save Current BIOS" icon shown in dialog box. It means to save the current BIOS version.

IV. Check out supported motherboard and Flash ROM:

In the very beginning, there is "About this program" icon shown in dialog box. It can help you check out which kind of motherboard and which brand of Flash ROM are supported.

Note:

- a. In method I, if it shows two or more motherboard's model names to be selected, please make sure your motherboard's model name again. Selecting name will cause the system unbooted.
- b. In method II, be sure that motherboard's model name in BIOS unzip file are the same as your motherboard's. Otherwise, your system won't boot.
- c. In method I, if the BIOS file you need cannot be found in @BIOS™ server, please go onto Gigabyte's web site for downloading and updating it according to method II.
- d. Please note that any interruption during updating will cause system unbooted

Or else you can select flash BIOS in DOS mode.

● Please check your **BIOS vendor (AMI or AWARD)**, your **motherboard name** and **PCB version** on the motherboard.

1. Format a bootable system floppy diskette by the command "**format a:/s**" in command mode.
2. Visit the Gigabyte website at [http:// www.gigabyte.com.tw](http://www.gigabyte.com.tw) , Select the BIOS file you need and download it to your bootable floppy diskette.
3. Insert the bootable diskette containing the BIOS file into the floppy diskette driver.
4. Assuming that the floppy diskette driver is A, reboot the system by using the A: driver. At the A: > prompt, run the BIOS upgraded file by executing the Flash BIOS utility and the BIOS file with its appropriate extension.

Example: *(AMI tool) (Where 7dxr.f1 is name of the BIOS file name)*

```
A:>flashxxx.exe 7dxr.f1 ↵
```

Example: *(Award tool) (Where 7dxr.f1 is name of the BIOS file name)*

```
A:>Awdflash.exe 7dxr.f1 ↵
```

5. Upon pressing the <Enter> key, a flash memory writer menu will appear on screen. Enter the new BIOS file name with its extension filename into the text box after file name to program.
6. If you want to save the old BIOS file(perform as soon as system is operational, this is recommended), select Y to **DO YOU WANT TO SAVE BIOS**, then type the old BIOS filename and the extension after filename to save: This option allows you to copy the contents of the flash memory chip onto a diskette, giving you a backup copy of the original motherboard BIOS in case you need to re-install it. Select N to **DO YOU WANT TO SAVE BIOS**, if you don't want to save the old BIOS file.
7. After the decision to save the old BIOS file or not is made, select Y to **ARE YOU SURE TO PROGRAM** when the next menu appear; wait until a message showing Power Off or Reset the system appears. Then turn off your system.
8. Remove the diskette and restart your system.
9. Hold down <Delete> key to enter BIOS setup. You must select "Load Setup BIOS Default" to activate the new BIOS, then you may set other item from the main menu.

Appendix F: Acronyms

Acronyms	Meaning
ACPI	Advanced Configuration and Power Interface
APM	Advanced Power Management
AGP	Accelerated Graphics Port
AMR	Audio Modem Riser
ACR	Advanced Communications Riser
BIOS	Basic Input / Output System
CPU	Central Processing Unit
CMOS	Complementary Metal Oxide Semiconductor
CRIMM	Continuity RIMM
CNR	Communication and Networking Riser
DMA	Direct Memory Access
DMI	Desktop Management Interface
DIMM	Dual Inline Memory Module
DRM	Dual Retention Mechanism
DRAM	Dynamic Random Access Memory
DDR	Double Data Rate
ECP	Extended Capabilities Port
ESCD	Extended System Configuration Data
ECC	Error Checking and Correcting
EMC	Electromagnetic Compatibility
EPP	Enhanced Parallel Port
ESD	Electrostatic Discharge
FDD	Floppy Disk Device
FSB	Front Side Bus
HDD	Hard Disk Device
IDE	Integrated Dual Channel Enhanced
IRO	Interrupt Request
I/O	Input / Output
IOAPIC	Input Output Advanced Programmable Input Controller
ISA	Industry Standard Architecture
LAN	Local Area Network
LBA	Logical Block Addressing
LED	Light Emitting Diode
MHz	Megahertz
MIDI	Musical Interface Digital Interface
MTH	Memory Translator Hub
MPT	Memory Protocol Translator
NIC	Network Interface Card
OS	Operating System

To be continued...

7DXR Motherboard

Acronyms	Meaning
OEM	Original Equipment Manufacturer
PAC	PCI A.G.P. Controller
POST	Power-On Self Test
PCI	Peripheral Component Interconnect
RIMM	Rambus in-line Memory Module
SCI	Special Circumstance Instructions
SECC	Single Edge Contact Cartridge
SRAM	Static Random Access Memory
SMP	Symmetric Multi-Processing
SMI	System Management Interrupt
USB	Universal Serial Bus
VID	Voltage ID