



- 💣 The author assumes no responsibility for any errors or omissions that may appear in this document nor does the author make a commitment to update the information contained herein.
- 💣 Third-party brands and names are the property of their respective owners.
- 💣 Please do not remove any labels on motherboard, this may void the warranty of this motherboard.
- 💣 Due to rapid change in technology, some of the specifications might be out of date before publication of this booklet.
- 💣 Before you install PCI cards, please remove the Dual BIOS label from PCI slots if there is one.



**WARNING:** *Never run the processor without the heatsink properly and firmly attached. PERMANENT DAMAGE WILL RESULT!*

**Mise en garde :** *Ne faites jamais tourner le processeur sans que le dissipateur de chaleur soit fixé correctement et fermement. UN DOMMAGE PERMANENT EN RÉSULTERA !*

**Achtung:** *Der Prozessor darf nur in Betrieb genommen werden, wenn der Wärmeleiter ordnungsgemäß und fest angebracht ist. DIES HAT EINEN PERMANENTEN SCHADEN ZUR FOLGE!*

**Advertencia:** *Nunca haga funcionar el procesador sin el disipador de calor instalado correctamente y firmemente. ¡SE PRODUCIRÁ UN DAÑO PERMANENTE!*

**Aviso:** *Nunca execute o processador sem o dissipador de calor estar adequado e firmemente conectado. O RESULTADO SERÁ UM DANO PERMANENTE!*

**警告:** 將散熱板牢固地安裝到處理器上之前，不要運行處理器。過熱將永遠損壞處理器！

**警告:** 將散熱器牢固地安裝到處理器上之前，不要運行處理器。過熱將永遠損壞處理器！

**경고:** 히트싱크를 제대로 또 단단히 부착시키지 않은 채 프로세서를 구동시키지 마십시오. 영구적 고장이 발생합니다!

**警告:** 永久的な損傷を防ぐため、ヒートシンクを正しくしっかりと取り付けるまでは、プロセッサを動作させないようにしてください。

# Declaration of Conformity

We, Manufacturer/Importer  
(full address)

**G.B.T. Technology Trading GmbH**  
**Ausschlagler Weg 41, 1F, 20537 Hamburg, Germany**

declare that the product  
( description of the apparatus, system, installation to which it refers)

## **Mother Board**

GA-7VRX/GA-7VRXP  
is in conformity with

(reference to the specification under which conformity is declared)  
in accordance with 89/336 EEC-EMC Directive

- |   |  |  |  |
|---|--|--|--|
| <input type="checkbox"/> EN 55011   | Limits and methods of measurement of radio disturbance characteristics of industrial, scientific and medical (ISM high frequency equipment                 | <input type="checkbox"/> EN 61000-3-2*<br><input checked="" type="checkbox"/> EN 60555-2         | Disturbances in supply systems cause by household appliances and similar electrical equipment "Harmonics"  |
| <input type="checkbox"/> EN 55013   | Limits and methods of measurement of radio disturbance characteristics of broadcast receivers and associated equipment                                     | <input type="checkbox"/> EN 61000-3-3*<br><input checked="" type="checkbox"/> EN 60555-3         | Disturbances in supply systems cause by household appliances and similar electrical equipment "Voltage fluctuations"                                 |
| <input type="checkbox"/> EN 55014   | Limits and methods of measurement of radio disturbance characteristics of household electrical appliances, portable tools and similar electrical apparatus | <input checked="" type="checkbox"/> EN 50081-1<br><input checked="" type="checkbox"/> EN 50082-1 | Generic emission standard Part 1: Residual commercial and light industry<br>Generic immunity standard Part 1: Residual commercial and light industry |
| <input type="checkbox"/> EN 55015   | Limits and methods of measurement of radio disturbance characteristics of fluorescent lamps and luminaries   | <input type="checkbox"/> EN 55081-2  | Generic emission standard Part 2: Industrial environment   |
| <input type="checkbox"/> EN 55020   | Immunity from radio interference of broadcast receivers and associated equipment   | <input type="checkbox"/> EN 55082-2  | Generic emission standard Part 2: Industrial environment   |
| <input checked="" type="checkbox"/> EN 55022  | Limits and methods of measurement of radio disturbance characteristics of information technology equipment   | <input type="checkbox"/> ENV 55104   | Immunity requirements for household appliances tools and similar apparatus   |
| <input type="checkbox"/> DIN VDE 0855<br><input type="checkbox"/> part 10<br><input type="checkbox"/> part 12 | Cabled distribution systems: Equipment for receiving and/or distribution from sound and television signals   | <input type="checkbox"/> EN50091-2   | EMC requirements for uninterruptible power systems (UPS)   |

CE marking



(EC conformity marking)

**The manufacturer also declares the conformity of above mentioned product with the actual required safety standards in accordance with LVD 73/23 EEC**

- |                                   |   |                                     |
|-----------------------------------|---|-------------------------------------|
| <input type="checkbox"/> EN 60065 | Safety requirements for mains operated electronic and related apparatus for household and similar general use | <input type="checkbox"/> EN 60950   |
| <input type="checkbox"/> EN 60335 | Safety of household and similar electrical appliances   | <input type="checkbox"/> EN 50091-1 |

Manufacturer/Importer

(Stamp)

Date : Feb. 08, 2002

Signature: Timmy Huang  
Name: Timmy Huang

# DECLARATION OF CONFORMITY

Per FCC Part 2 Section 2.1077(a)



**Responsible Party Name: G.B.T.INC.(U.S.A.)**

**Address: 17358 Railroad Street  
City of Industry, CA 91748**

**Phone/FaxNo: (818) 854-9338/ (818) 854-9339**

hereby declares that the product

**ProductName: Motherboard**

**ModelNumber: GA-7VRX/GA-7VRXP**

Conforms to the following specifications:

FCC Part 15, Subpart B, Section 15.107(a) and Section  
15.109(a), Class B Digital Device

## **Supplementary Information:**

This device complies with part 15 of the FCC Rules. Operation is subject to the following two conditions: (1) This device may not cause harmful and (2) this device must accept any inference received, including that may cause undesired operation.

Representative Person's ERIC LU

Name: Signature: Eric Lu

Date: Feb.08,2002

GA-7VRX/GA-7VRXP  
AMD Socket A Processor Motherboard

# USER'S MANUAL

AMD Athlon™ Athlon™ XP / Duron™ Socket A Processor Motherboard

Rev. 1101

12ME-7VRX-1101

## Table Of Content

Item Checklist .....	8
WARNING! .....	8
Chapter 1 Introduction .....	9
Summary of Features .....	9
GA-7VRX/GA-7VRXP Motherboard Layout .....	11
Chapter 2 Hardware Installation Process .....	12
Step 1: Install the Central Processing Unit (CPU).....	13
Step1-1: CPU Speed Setup .....	13
Step1-2: CPU Installation .....	14
Step1-3:CPU Heat Sink Installation .....	15
Step 2: Install memory modules .....	16
Step 3: Install expansion cards .....	18
Step 4: Connect ribbon cables, cabinet wires, and power supply .....	19
Step4-1:I/O Back Panel Introduction .....	19
Step4-2: Connectors Introduction .....	21
Chapter 3 BIOS Setup .....	26
The Main Menu (For example: BIOS Ver. :F4) .....	27
Standard CMOS Features.....	29
BIOS Features Setup .....	32
Chipset Features Setup .....	35
Power Management Setup .....	39
PNP/PCI Configuration .....	42
Load Fail-Safe Defaults .....	44

---

Load Optimized Defaults .....	45
Integrated Peripherals .....	46
Hardware Monitor & MISC Setup .....	51
Set Supervisor / User Password .....	53
IDE HDD Auto Detection .....	54
Save & Exit Setup .....	55
Exit Without Saving .....	56
Chapter 4 Technical Reference .....	57
Block Diagram .....	57
Dual BIOS & Q-Flash Utility Introduction .....	58
SPDIF Introduction (For GA-7VRXP Only) .....	67
@ BIOS Introduction .....	69
Easy Tunell™ Introduction .....	70
RAID Introduction .....	71
Chapter 5 Appendix .....	89

## Item Checklist

- |  |   |
|--|---|
| <input checked="" type="checkbox"/> The GA-7VRX/GA-7VRXP motherboard       | <input checked="" type="checkbox"/> CD for motherboard driver & utility |
| <input checked="" type="checkbox"/> IDE cable x 1/ Floppy cable x 1(7VRX)  | <input checked="" type="checkbox"/> GA-7VRX/GA-7VRXP user's manual      |
| <input checked="" type="checkbox"/> IDE cable x 3/ Floppy cable x 1(7VRXP) | <input checked="" type="checkbox"/> USB Cable (only for GA-7VRXP)       |

## WARNING!



Computer motherboards and expansion cards contain very delicate Integrated Circuit (IC) chips. To protect them against damage from static electricity, you should follow some precautions whenever you work on your computer.

1. Unplug your computer when working on the inside.
2. Use a grounded wrist strap before handling computer components. If you do not have one, touch both of your hands to a safely grounded object or to a metal object, such as the power supply case.
3. Hold components by the edges and try not touch the IC chips, leads or connectors, or other components.
4. Place components on a grounded antistatic pad or on the bag that came with the components whenever the components are separated from the system.
5. Ensure that the ATX power supply is switched off before you plug in or remove the ATX power connector on the motherboard.

### Installing the motherboard to the chassis...

If the motherboard has mounting holes, but they don't line up with the holes on the base and there are no slots to attach the spacers, do not become alarmed you can still attach the spacers to the mounting holes. Just cut the bottom portion of the spacers (the spacer may be a little hard to cut off, so be careful of your hands). In this way you can still attach the motherboard to the base without worrying about short circuits. Sometimes you may need to use the plastic springs to isolate the screw from the motherboard PCB surface, because the circuit wire may be near by the hole. Be careful, don't let the screw contact any printed circuit write or parts on the PCB that are near the fixing hole, otherwise it may damage the board or cause board malfunctioning.



# Chapter 1 Introduction

## Summary of Features

Form Factor	<ul style="list-style-type: none"> <li>• 30.5cm x 23.5cm ATX size form factor, 4 layers PCB.</li> </ul>
Motherboard	<ul style="list-style-type: none"> <li>• GA-7VRX/GA-7VRXP Motherboard</li> </ul>
CPU	<ul style="list-style-type: none"> <li>• Socket A processor AMD Athlon™/Athlon™ XP/ Duron™ (K7) 128K L1 &amp; 256K/64K L2 cache on die 200/266MHz FSB and DDR bus speeds</li> <li>• Supports 1.4GHz and faster</li> </ul>
Chipset	<ul style="list-style-type: none"> <li>• VIA KT333 Memory/AGP/PCI Controller (PAC)</li> <li>• VIA VT8233A(CE) Integrated Peripheral Controller (PSIPC)</li> </ul>
Memory	<ul style="list-style-type: none"> <li>• 3 184-pin DDR sockets</li> <li>• Supports DDR DRAM PC1600/PC2100/PC2700<sup>&lt;Note 1&gt;</sup></li> <li>• Supports up to 3.0GB DDR (Max)</li> <li>• Supports only 2.5V DDR DIMM</li> </ul>
I/O Control	<ul style="list-style-type: none"> <li>• IT8705</li> </ul>
Slots	<ul style="list-style-type: none"> <li>• 1 AGP slot supports 4X/2X mode &amp; AGP 2.0 Compliant</li> <li>• 5 PCI slots supports 33MHz &amp; PCI 2.2 compliant</li> </ul>
On-Board IDE	<ul style="list-style-type: none"> <li>• 2 IDE controllers provides IDE HDD/CD-ROM (IDE1, IDE2) with PIO, Bus Master (Ultra DMA33/ATA66/ATA100/ATA133) operation modes.</li> <li>• IDE3 and IDE4 Compatible with RAID, Ultra ATA133/100, EIDE</li> </ul>
On-Board Peripherals	<ul style="list-style-type: none"> <li>• 1 Floppy port supports 2 FDD with 360K, 720K, 1.2M, 1.44M and 2.88M bytes.</li> <li>• 1 Parallel port supports Normal/EPP/ECP mode</li> <li>• 2 Serial port (COMA &amp; COMB)</li> <li>• 4 x USB 2.0 by cable , 2 x USB 1.1 by cable and 2 x USB 1.1 onboard</li> <li>• 1 IrDA connector for IR</li> </ul>

<Note 1> Because the quality of PC2700 module is varied, we don't recommend you to use 3pcs of PC2700 module at the same time.

\*\*\* Only for GA-7VRXP.

to be continued.....

Hardware Monitor	<ul style="list-style-type: none"><li>• CPU/System Fan Revolution detect</li><li>• CPU/System temperature detect</li><li>• System Voltage Detect</li></ul>
On-Board Sound	<ul style="list-style-type: none"><li>• Creative CT5880 Sound Chipset*</li><li>• Sigmatel 9721T CODEC</li><li>• Line In/Line Out/Mic In/CD In/Game Port</li></ul>
On-Board RAID*	<ul style="list-style-type: none"><li>• Onboard Promise PDC20276</li><li>• Supports data striping (RAID 0) or mirroring (RAID 1)</li><li>• Supports concurrent dual IDE controller operation</li><li>• Supports IDE bus master operation</li><li>• Displays status and error checking messages during boot-up</li><li>• Mirroring supports automatic background rebuilds</li><li>• Features LBA and Extended Interrupt 13 drive translation in controller onboard BIOS</li></ul>
On-Board LAN*	<ul style="list-style-type: none"><li>• RealTek TRL8100BL</li></ul>
On-Board USB 2.0	<ul style="list-style-type: none"><li>• VIA VT6202</li></ul>
On-Board MS,SD,SC*	<ul style="list-style-type: none"><li>• Winbond SMART @I/O Chipset (Memory Stick , Security Digital and SC header)</li></ul>
PS/2 Connector	<ul style="list-style-type: none"><li>• PS/2 Keyboard interface and PS/2 Mouse interace</li></ul>
BIOS	<ul style="list-style-type: none"><li>• Licensed AMI BIOS, 2M bit flash ROM</li><li>• Supports Dual BIOS</li><li>• Supports Q-Flash</li></ul>
Additional Features	<ul style="list-style-type: none"><li>• Wake on LAN (WOL)</li><li>• Supports @BIOS™</li><li>• Supports EasyTuneIII™</li></ul>

---

☛ Please set the CPU host frequency in accordance with your processor's specifications. We don't recommend you to set the system bus frequency over the CPU's specification because these specific bus frequencies are not the standard specifications for CPU, chipset and most of the peripherals. Whether your system can run under these specific bus frequencies properly will depend on your hardware configurations, including CPU, Chipsets,SDRAM,Cards....etc.

\*\*\* Only for GA-7VRXP.

# GA-7VRX/GA-7VRXP Motherboard Layout

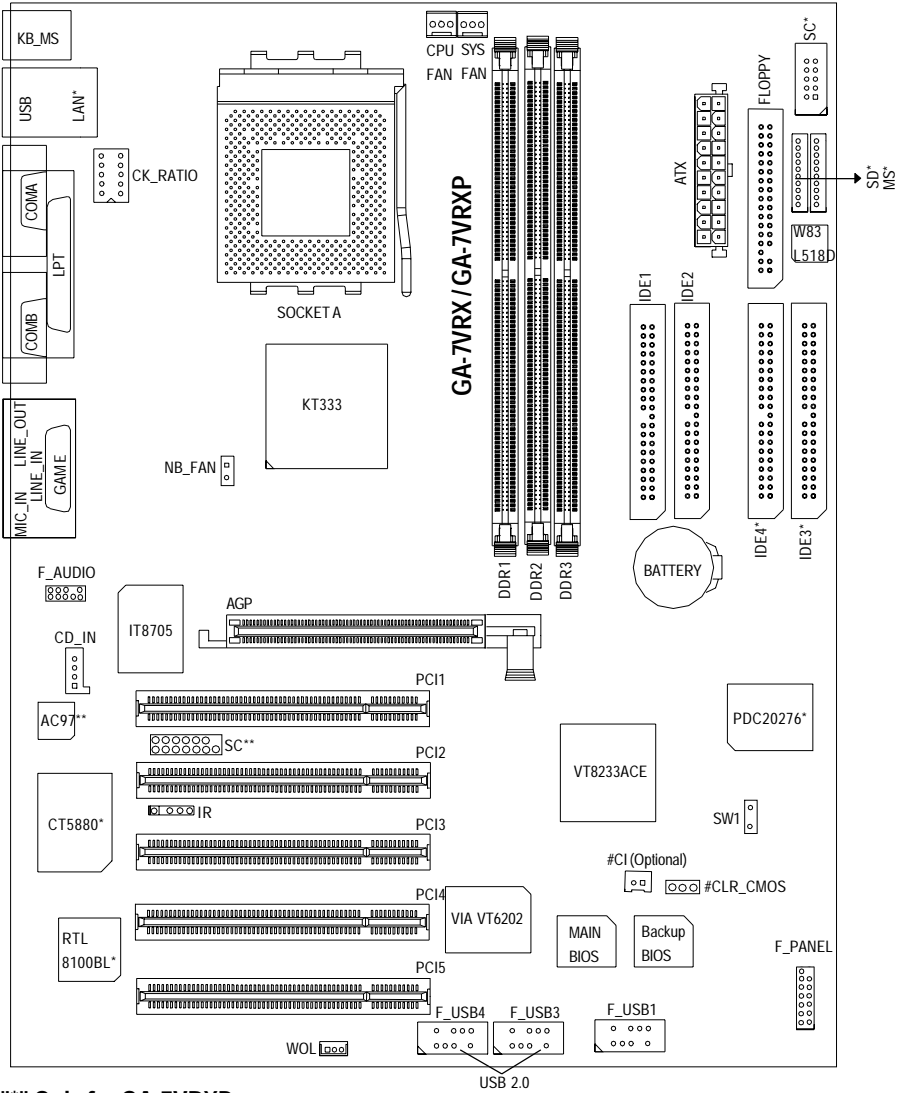

\*\*\* Only for GA-7VRXP.

\*\*\*\* Only for GA-7VRX.

## Only for GA-7VRX/GA-7VRXP PCB Ver.1.1 use.

# Chapter 2 Hardware Installation Process

To set up your computer, you must complete the following sets:

- Step 1- Set Dip Switch (CK\_RATIO) and system Switch (SW1)
- Step 2- Install the Central Processing Unit (CPU)
- Step 3- Install memory modules
- Step 4- Install expansion cards
- Step 5- Connect ribbon cables, cabinet wires, and power supply
- Step 6- Setup BIOS software
- Step 7- Install supporting software tools

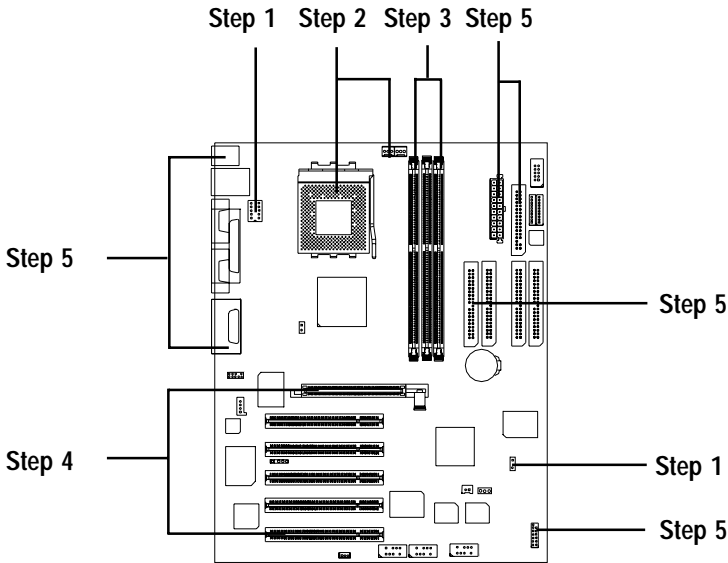

# Step 1: Install the Central Processing Unit (CPU)

## Step1-1: CPU Speed Setup

The clock ratio can be switched by CK\_RATIO and refer to below table.

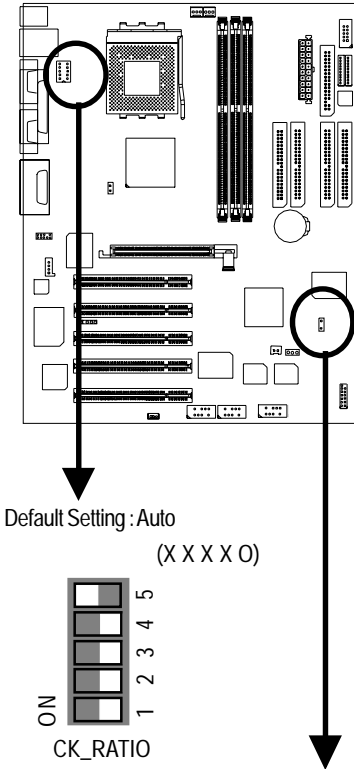

CLK\_RATIO                      O: ON / X :OFF

RATIO	1	2	3	4	5
AUTO(Default)	X	X	X	X	O
5x	O	O	X	O	X
5.5x	X	O	X	O	X
6x	O	X	X	O	X
6.5x	X	X	X	O	X
7x	O	O	O	X	X
7.5x	X	O	O	X	X
8x	O	X	O	X	X
8.5x	X	X	O	X	X
9x	O	O	X	X	X
9.5x	X	O	X	X	X
10x	O	X	X	X	X
10.5x	X	X	X	X	X
11x	O	O	O	O	X
11.5x	X	O	O	O	X
12x	O	X	O	O	X
>=12.5x	X	X	O	O	X

O: ON / X :OFF



SW1	1:CPU CLOCK
1:ON	100MHz (Default)
1:OFF	133MHz

The system bus frequency can be switched at 100/133MHz by adjusting system switch (SW1).  
(The internal frequency depend on CPU.)

## Step1-2: CPU Installation

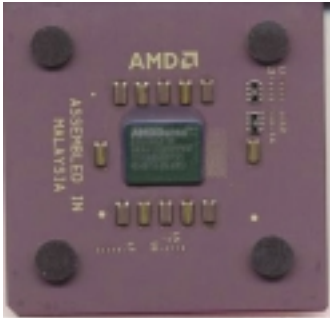

CPU Top View

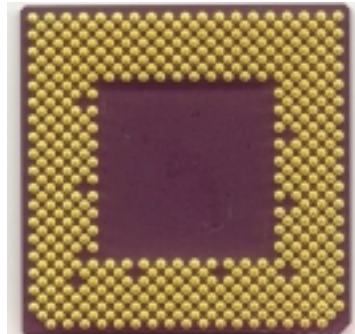

CPU Bottom View

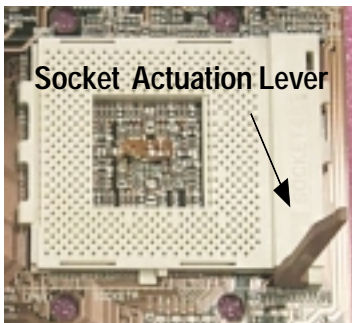

1. Pull up the CPU socket lever and up to 90-degree angle.

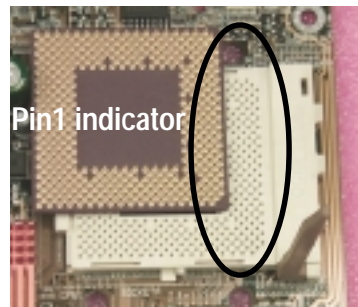

2. Locate Pin 1 in the socket and look for a (golden) cut edge on the CPU upper corner. Then insert the CPU into the socket.

- ⚡ Please make sure the CPU type is supported by the motherboard.
- ⚡ If you do not match the CPU socket Pin 1 and CPU cut edge well, it will cause improper installation. Please change the insert orientation.

### Step1-3:CPU Heat Sink Installation



1. Press down the CPU socket lever and finish CPU installation.

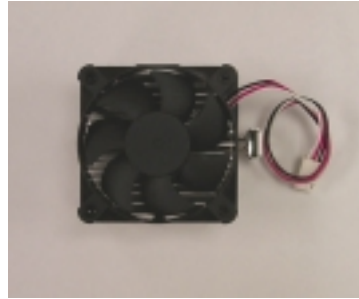

2. Use qualified fan approved by AMD.

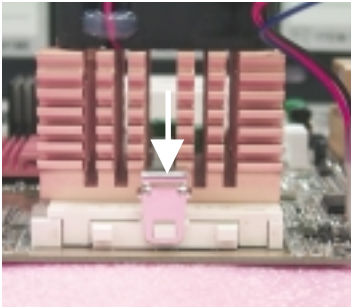

3. Fasten the heatsink supporting-base onto the CPU socket on the main-board.

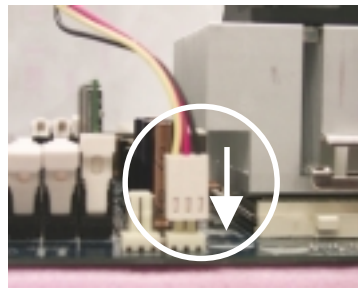

4. Make sure the CPU fan is plugged to the CPU fan connector, than install complete.

- ⚠ Please use AMD approved cooling fan.
- ⚠ We recommend you to apply the thermal paste to provide better heat conduction between your CPU and heatsink.
- ⚠ Make sure the CPU fan power cable is plugged in to the CPU fan connector, this completes the installation.
- ⚠ Please refer to CPU heat sink user's manual for more detail installation procedure.

## Step 2: Install memory modules

The motherboard has 3 dual inline memory module(DIMM) sockets. The BIOS will automatically detects memory type and size. To install the memory module, just push it vertically into the DIMM Slot.

The DIMM module can only fit in one direction due to the notch. Memory size can vary between sockets.

### Total Memory Sizes With Registered DDR DIMM

Devices used on DIMM	1 DIMMx64/x72	2 DIMMsx64/x72	3 DIMMsx64/x72
64 Mbit (4Mx4x4 banks)	256 MBytes	512 MBytes	768 MBytes
64 Mbit (2Mx8x4 banks)	128 MBytes	256 MBytes	384 MBytes
64 Mbit (1Mx16x4 banks)	64 MBytes	128 MBytes	192 MBytes
128 Mbit(8Mx4x4 banks)	512 MBytes	1 GBytes	1.5 GBytes
128 Mbit(4Mx8x4 banks)	256 MBytes	512 MBytes	768 MBytes
128 Mbit(2Mx16x4 banks)	128 MBytes	256 MBytes	384 MBytes
256 Mbit(16Mx4x4 banks)	1 GBytes	2 GBytes	3 GBytes
256 Mbit(8Mx8x4 banks)	512 MBytes	1 GBytes	1.5 GBytes
256 Mbit(4Mx16x4 banks)	256 MBytes	512 MBytes	768 MBytes
512 Mbit(16Mx8x4 banks)	1 GBytes	2 GBytes	3 GBytes
512 Mbit(8Mx16x4 banks)	512 MBytes	1 GBytes	1.5 GBytes

### Total Memory Sizes With Unbuffered DDR DIMM

Devices used on DIMM	1 DIMMx64/x72	2 DIMMsx64/x72	3 DIMMsx64/x72
64 Mbit (2Mx8x4 banks)	128 MBytes	256 MBytes	384 MBytes
64 Mbit (1Mx16x4 banks)	64 MBytes	128 MBytes	192 MBytes
128 Mbit(4Mx8x4 banks)	256 MBytes	512 MBytes	768 MBytes
128 Mbit(2Mx16x4 banks)	128 MBytes	256 MBytes	384 MBytes
256 Mbit(8Mx8x4 banks)	512 MBytes	1 GBytes	1.5 GBytes
256 Mbit(4Mx16x4 banks)	256 MBytes	512 MBytes	768 MBytes
512 Mbit(16Mx8x4 banks)	1 GBytes	2 GBytes	3 GBytes
512 Mbit(8Mx16x4 banks)	512 MBytes	1 GBytes	1.5 GBytes





DDR



1. The DIMM slot has a notch, so the DIMM memory module can only fit in one direction.
  2. Insert the DIMM memory module vertically into the DIMM slot. Then push it down.
  3. Close the plastic clip at both edges of the DIMM slots to lock the DIMM module.
- 🔧 Reverse the installation steps when you wish to remove the DIMM module.

## DDR Introduction

Established on the existing SDRAM industry infrastructure, DDR (Double Data Rate) memory is a high performance and cost-effective solution that allows easy adoption for memory vendors, OEMs and system integrators.

DDR memory is a sensible evolutionary solution for the PC industry that builds on the existing SDRAM infrastructure, yet makes awesome advances in solving the system performance bottleneck by doubling the memory bandwidth. DDR SDRAM will offer a superior solution and migration path from existing SDRAM designs due to its availability, pricing and overall market support. PC2100 DDR memory (DDR266) doubles the data rate through reading and writing at both the rising and falling edge of the clock, achieving data bandwidth 2X greater than PC133 when running with the same DRAM clock frequency. With peak bandwidth of 2.1GB per second, DDR memory enables system OEMs to build high performance and low latency DRAM subsystems that are suitable for servers, workstations, high-end PC's and value desktop SMA systems. With a core voltage of only 2.5 Volts compared to conventional SDRAM's 3.3 volts, DDR memory is a compelling solution for small form factor desktops and notebook applications.

🔧 When STR/DIMM LED is ON, do not install/remove DDR from socket.

## Step 3: Install expansion cards

1. Read the related expansion card's instruction document before install the expansion card into the computer.
2. Remove your computer's chassis cover, screws and slot bracket from the computer.
3. Press the expansion card firmly into expansion slot in motherboard.
4. Be sure the metal contacts on the card are indeed seated in the slot.
5. Replace the screw to secure the slot bracket of the expansion card.
6. Replace your computer's chassis cover.
7. Power on the computer, if necessary, setup BIOS utility of expansion card from BIOS.
8. Install related driver from the operating system.



AGP Card

Please carefully pull out the small white-drawable bar at the end of the AGP slot when you try to install/ Uninstall the AGP card. Please align the AGP card to the onboard AGP slot and press firmly down on the slot .Make sure your AGP card is locked by the small white- drawable bar.

## Step 4: Connect ribbon cables, cabinet wires, and power supply

### Step4-1:I/O Back Panel Introduction

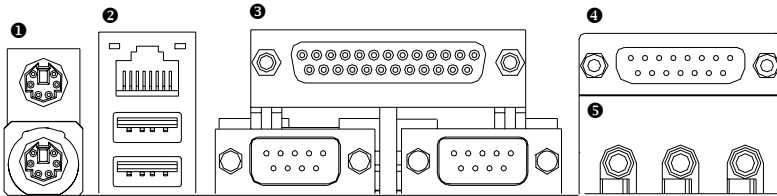

#### ❶ PS/2 Keyboard and PS/2 Mouse Connector

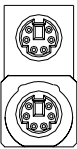

PS/2 Mouse Connector  
(6 pin Female)

PS/2 Keyboard Connector  
(6 pin Female)

➤ This connector supports standard PS/2 keyboard and PS/2 mouse.

#### ❷ USB & LAN Connector

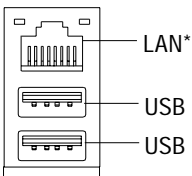

➤ Before you connect your device(s) into USB connector(s), please make sure your device(s) such as USB keyboard, mouse, scanner, zip, speaker..etc. Have a standard USB interface. Also make sure your OS (Win 95 with USB supplement, Win98, Windows 2000, Windows ME, Win NT with SP 6) supports USB controller. If your OS does not support USB controller, please contact OS vendor for possible patch or driver upgrade.

For more information please contact your OS or device(s) vendors.

\*\*\* Only for GA-7VRXP.

### ③ Parallel Port , Serial Ports (COMA / COMB)

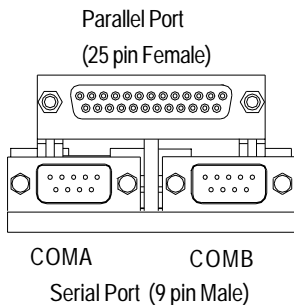

- This connector supports 2 standard COM ports ,1 Parallel port . Device like printer can be connected to Parallel port ; mouse and modem etc can be connected to Serial ports.

### ④ Game /MIDI Ports

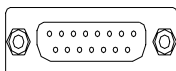

Joystick/ MIDI (15 pin Female)

- This connector supports joystick, MIDI keyboard and other relate audio devices.

### ⑤ Audio Connectors

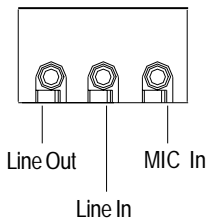

- After install onboard audio driver, you may connect speaker to Line Out jack, micro phone to MIC In jack. Device like CD-ROM , walkman etc can be connected to Line-In jack.

## Step4-2: Connectors Introduction

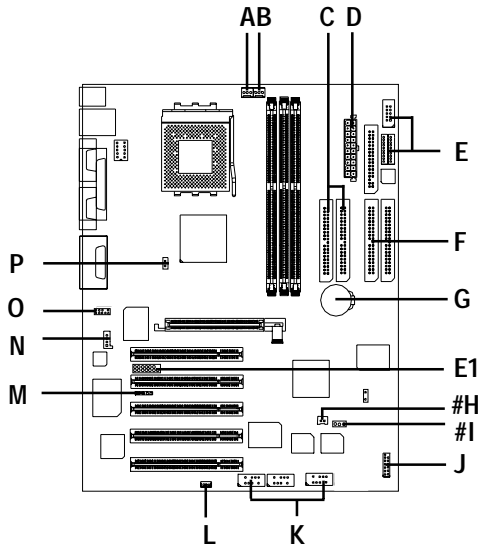

A) CPU FAN	I) CLR_CMOS#
B) SYS FAN	J) F_Panel
C) Floppy/IDE1/IDE2	K) F_USB1,3,4
D) ATX	L) WOL
E/E1)SC/SD/MS* / SC**	M) IR
F) IDE3/IDE4*	N) CD_IN
G) Battery	O) F_AUDIO
H) Cl#	P) NB_FAN

\*\*\* Only for GA-7VRXP.

\*\*\*\* Only for GA-7VRX.

## Only for GA-7VRX/GA-7VRXP PCB Ver.1.1 use.

**A) CPU\_FAN (CPU\_FAN Connector)**



**B) SYS\_FAN (SYS\_FAN Connector)**



- The CPU fan connector supports Max. current up to 600 mA .

**D) ATX (ATX Power)**

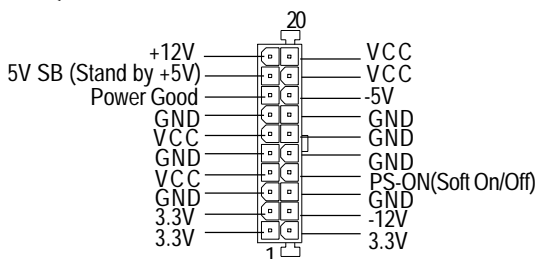

- AC power cord should only be connected to your power supply unit after ATX power cable and other related devices are firmly connected to the mainboard.

**C) Floppy / IDE1 / IDE2**

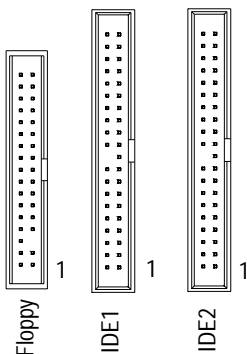

- Important Notice:  
Please connect first harddisk to IDE1 and connect CDROM to IDE2.

**K) F\_USB1,3,4**  
**(F\_USB3 & 4 connectors in orange are for USB 2.0)**

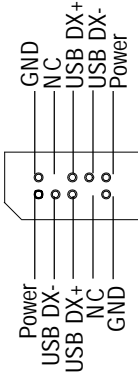

- Be careful with the polarity of the front panel USB connector. Check the pin assignment while you connect the front panel USB cable. Please contact your nearest dealer for optional front panel USB cable.

**M) IR**

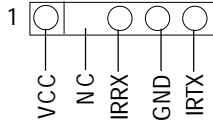

- Be careful with the polarity of the IR connector while you connect the IR. Please contact your nearest dealer for optional IR device.

**F) IDE3/IDE4 Connector (RAID/ATA133)\***

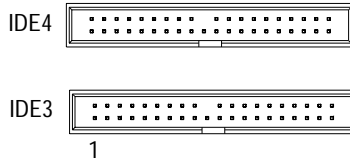

**L) WOL (Wake On LAN)**

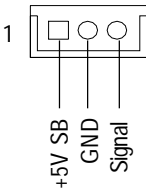

**N) CD\_IN**

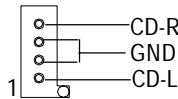

\*\*\* Only for GA-7VRXP.

### D) F\_AUDIO (Front\_AUDIO Connector)

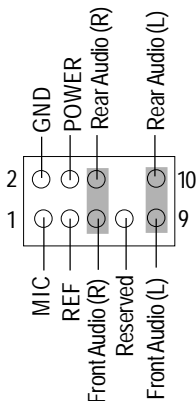

- If you want to use Front Audio connector, you must remove 5-6, 9-10 Jumper. In order to utilize the front audio header, your chassis must have front audio connector. Also please make sure the pin assignment on the cable is the same as the pin assignment on the MB header. To find out if the chassis you are buying support front audio connector, please contact your dealer.

### E/E1) SC(Smart Card Interface), SD (Secure Digital Memory Card Interface) , MS (Memory Stick Interface)

(There is either function of SD and MS can be used.)

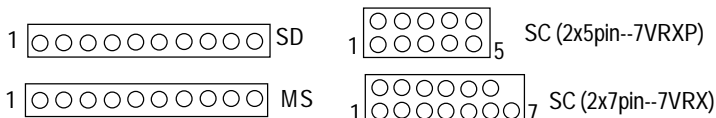

### H) CI (Case Open)

Only for GA-7VRX/GA-7VRXP

PCB Ver. 1.1 use.

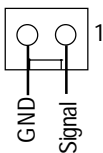

### P) NB\_FAN

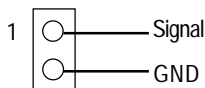

### I) CLR\_CMOS: Clear CMOS

Only for GA-7VRX/GA-7VRXP

PCB Ver. 1.1 use.

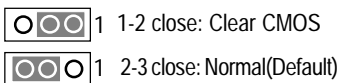



**J) F\_PANEL (2x7 pins jumper)**

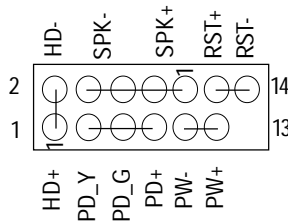

HD (IDE Hard Disk Active LED)	Pin 1: LED anode(+) Pin 2: LED cathode(-)
SPK (Speaker Connector)	Pin 1: VCC(+) Pin 2- Pin 3: NC Pin 4: Data(-)
RST (Reset Switch)	Open: Normal Operation Close: Reset Hardware System
PD+/PD_G/PD_Y(Power LED)	Pin 1: LED anode(+) Pin 2: LED cathode(-) Pin 3: LED cathode(-)
PW (Soft Power Connector)	Open: Normal Operation Close: Power On/Off

- Please connect the power LED, PC speaker, reset switch and power switch etc of your chassis front panel to the front panel jumper according to the pin assignment above.

**G) Battery**

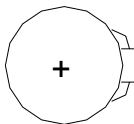

**CAUTION**

- ❖ Danger of explosion if battery is incorrectly replaced.
- ❖ Replace only with the same or equivalent type recommended by the manufacturer.
- ❖ Dispose of used batteries according to the manufacturer's instructions.

## Chapter 3 BIOS Setup

BIOS Setup is an overview of the BIOS Setup Program. The program that allows users to modify the basic system configuration. This type of information is stored in battery-backed CMOS RAM so that it retains the Setup information when the power is turned off.

### ENTERING SETUP

Power ON the computer and press <Del> immediately will allow you to enter Setup. If the message disappears before you respond and you still wish to enter Setup, restart the system to try again by turning it OFF then ON or pressing the "RESET" button on the system case. You may also restart by simultaneously press <Ctrl> - <Alt>- <Del> keys.

### CONTROL KEYS

<Left>	Move to previous item
<Right>	Move to next item
<Left>	Move to the item in the left hand
<Right>	Move to the item in the right hand
<Esc>	Main Menu - Quit and not save changes into CMOS Status Page Setup Menu and Option Page Setup Menu - Exit current page and return to Main Menu
<+/PgUp>	Increase the numeric value or make changes
<-/PgDn>	Decrease the numeric value or make changes
<F1>	General help, only for Status Page Setup Menu and Option Page Setup Menu
<F2>	Reserved
<F3>	Reserved
<F4>	Reserved
<F5>	Restore the previous CMOS value from CMOS, only for Option Page Setup Menu
<F6>	Load the default CMOS value from BIOS default table, only for Option Page Setup Menu
<F7>	Load the Setup Defaults
<F8>	Reserved
<F9>	Reserved
<F10>	Save all the CMOS changes, only for Main Menu

**GETTING HELP**

**Main Menu**

The on-line description of the highlighted setup function is displayed at the bottom of the screen.

**Status Page Setup Menu / Option Page Setup Menu**

Press F1 to pop up a small help window that describes the appropriate keys to use and the possible selections for the highlighted item. To exit the Help Window press <Esc>.

**The Main Menu (For example: BIOS Ver. :F4)**

Once you enter AMI BIOS CMOS Setup Utility, the Main Menu (Figure 1) will appear on the screen. The Main Menu allows you to select from eight setup functions and two exit choices. Use arrow keys to select among the items and press <Enter> to accept or enter the sub-menu.

AMIBIOS SIMPLE SETUP UTILITY - VERSION 1.24k (C) 1999 American Megatrends, Inc. All Rights Reserved	
STANDARD CMOS SETUP BIOS FEATURES SETUP CHIPSET FEATURES SETUP POWER MANAGEMENT SETUP PNP / PCI CONFIGURATION LOAD FAIL-SAFE DEFAULTS LOAD OPTIMIZED DEFAULTS	INTEGRATED PERIPHERALS HARDWARE MONITOR & MISC SETUP SUPERVISOR PASSWORD USER PASSWORD IDE HDD AUTO DETECTION SAVE & EXIT SETUP EXIT WITHOUT SAVING
ESC: Quit    ↓ ↓ ↓ ↓ ↓ : Select Item    (Shift)F2 : Change Color    F5: Old Values F6: Fail-Safe Values    F7: Optimized Values    F8: Dual BIOS/Q-Flash    F10: Save & Exit	
Time, Date , Hard Disk Type...	

Figure 1: Main Menu

**Standard CMOS Features**

This setup page includes all the items in standard compatible BIOS.

**BIOS Features Setup**

This setup page includes all the adjustable items of AMI special enhanced features.

**Chipset Features Setup**

This setup page includes all the adjustable items of chipset special features.

✍ **Power Management Setup**

This setup page includes all the adjustable items of Green function features.

✍ **PNP/PCI Configurations**

This setup page includes all the adjustable configurations of PCI & PnP ISA resources.

✍ **Load Fail-Safe Defaults**

Load Fail-Safe Defaults option loads preset system parameter values to set the system in its most stable configurations.

✍ **Load Optimized Defaults**

Load Optimized Defaults option loads preset system parameter values to set the system in its highest performance configurations.

✍ **Integrated Peripherals**

This setup page includes all onboard peripherals.

✍ **Hardware Monitor & MIS C Setup**

This setup page is auto detect fan and temperature status.

✍ **Set Supervisor password**

Set Change or disable password. It allows you to limit access to the system and/or BIOS setup.

✍ **Set User password**

Set Change or disable password. It allows you to limit access to the system.

✍ **IDE HDD Auto Detection**

Automatically configure hard disk parameters.

✍ **Save & Exit Setup**

Save CMOS value settings to CMOS and exit setup.

✍ **Exit Without Saving**

Abandon all CMOS value changes and exit setup.





## Standard CMOS Features

AMIBIOS SETUP - STANDARD CMOS SETUP	
( C ) 1999 American Megatrends, Inc. All Rights Reserved	
Date (mm/dd/yyyy) : Fri Mar 16, 2001	
Time (hh/mm/ss) : 14:44:35	
TYPE SIZE CYLS HEAD PRECOMP LANDZ SECTOR MODE	
Pri Master : Auto	
Pri Slave : Auto	
Sec Master : Auto	
Sec Slave : Auto	
Floppy Drive A : 1.44 MB 3 <sup>1/2</sup>	Base Memory : 640 Kb
Floppy Drive B : Not Installed	Other Memory : 384 Kb
	Extended Memory : 127 Mb
Boot Sector Virus Protection : Disabled	Total Memory : 128 Mb
Month : Jan - Dec	ESC : Exit
Day : 01- 31	↵ : Select Item
Year : 1990 - 2099	PU / PD / + / - :Modify
	(Shift) F2 : Color

Figure 2: Standard CMOS Setup

### Date

The date format is <week>, <month>, <day>, <year>.

-  Week      The week, from Sun to Sat, determined by the BIOS and is display only
-  Month      The month, Jan. Through Dec.
-  Day        The day, from 1 to 31 (or the maximum allowed in the month)
-  Year        The year, from 1990 through 2099

☞ **Time**

The times format in <hour> <minute> <second>. The time is calculated base on the 24-hour military-time clock. For example, 1 p.m. is 13:00:00.

☞ **Primary Master, Slave / Secondary Master, Slave**

The category identifies the types of hard disk from drive C to F that has been installed in the computer. There are two types: auto type, and manual type. Manual type is user-definable; Auto type which will automatically detect HDD type.

Note that the specifications of your drive must match with the drive table. The hard disk will not work properly if you enter improper information for this category.

If you select User Type, related information will be asked to enter to the following items. Enter the information directly from the keyboard and press <Enter>. Such information should be provided in the documentation from your hard disk vendor or the system manufacturer.

- |            |                     |
|------------|---------------------|
| ☞ CYLS.    | Number of cylinders |
| ☞ HEADS    | number of heads     |
| ☞ PRECOMP  | write precomp       |
| ☞ LANDZONE | Landing zone        |
| ☞ SECTORS  | number of sectors   |

If a hard disk has not been installed select NONE and press <Enter>.

☞ **Floppy Drive A / Drive B**

The category identifies the types of floppy disk drive A or drive B that has been installed in the computer.

- |                  |   |
|------------------|---|
| ☞ None           | No floppy drive installed   |
| ☞ 360K, 5.25 in. | 5.25 inch PC-type standard drive; 360K byte capacity.                                       |
| ☞ 1.2M, 5.25 in. | 5.25 inch AT-type high-density drive; 1.2M byte capacity (3.5 inch when 3 Mode is Enabled). |
| ☞ 720K, 3.5 in.  | 3.5 inch double-sided drive; 720K byte capacity   |
| ☞ 1.44M, 3.5 in. | 3.5 inch double-sided drive; 1.44M byte capacity.   |
| ☞ 2.88M, 3.5 in. | 3.5 inch double-sided drive; 2.88M byte capacity.   |

### **Boot Sector Virus Protection**

If it is set to enable, the category will flash on the screen when there is any attempt to write to the boot sector or partition table of the hard disk drive. The system will halt and the following error message will appear in the mean time. You can run anti-virus program to locate the problem.

- Enabled     Activate automatically when the system boots up causing a warning message to appear when anything attempts to access the boot sector or hard disk partition table
  
- Disabled     No warning message to appear when anything attempts to access the boot sector or hard disk partition table (Default Value)

### **Memory**

The category is display-only which is determined by POST (Power On Self Test) of the BIOS.

#### **Base Memory**

The POST of the BIOS will determine the amount of base (or conventional) memory installed in the system.

The value of the base memory is typically 512 K for systems with 512 K memory installed on the motherboard, or 640 K for systems with 640 K or more memory installed on the motherboard.

#### **Other Memory**

This refers to the memory located in the 640 K to 1024 K address space. This is memory that can be used for different applications.

DOS uses this area to load device drivers to keep as much base memory free for application programs. Most use for this area is Shadow RAM.

#### **Extended Memory**

The BIOS determines how much extended memory is present during the POST.

This is the amount of memory located above 1 MB in the CPU's memory address map.

## BIOS Features Setup

AMIBIOS SETUP - BIOS FEATURES SETUP	
( C ) 1999 American Megatrends, Inc. All Rights Reserved	
1st Boot Device	: Floppy
2nd Boot Device	: IDE-0
3rd Boot Device	: CDROM
S.M.A.R.T. for Hard Disks	: Disabled
Interrupt Mode	: APIC
BootUp Num-Lock	: On
Floppy Drive Seek	: Disabled
Password Check	: Setup
BIOS Flash Protection	: Auto
ESC: Quit    ↵ ↵ ↵ ↵ ↵ ↵ ↵ : Select Item F1 : Help                      PU/PD+/- : Modify F5 : Old Values                (Shift)F2: Color F6 : Fail-Safe                  F7: Optimized F8 :Dual BIOS/Q-Flash	

Figure 3: BIOS Features Setup

### 🔍 1st / 2nd / 3rd Boot device

- 🖥️ Floppy                Select your boot device priority by Floppy .
- 🖥️ ZIP A:/LS120        Select your boot device priority by ZIP A:/LS120.
- 🖥️ ATAPI ZIP C:        Select your boot device priority by ATAPI ZIP C:.
- 🖥️ CDROM                Select your boot device priority by CDROM.
- 🖥️ SCSI                    Select your boot device priority by SCSI.
- 🖥️ NETWORK             Select your boot device priority by NETWORK.
- 🖥️ Disabled             Disable this function.
- 🖥️ IDE-0~3              Select your boot device priority by IDE-0~3.
- 🖥️ USB FDD              Select your boot device priority by USB FDD.



---

### ⌘ S.M.A.R.T. for Hard Disks

- ☑ Enabled Enable HDD S.M.A.R.T. Capability .
- ☑ Disabled Disable HDD S.M.A.R.T. Capability . (Default value)

### ⌘ Interrupt Mode

- ☑ APIC Through IOAPIC generate more IRQ for system use.(Default value)
- ☑ PIC Use AT standard IRQ controller to generate IRQ.

When you already have IOAPIC enable system and want to upgrade the system please note, since running an IOAPIC enabled OS (like Windows NT, Windows 2000, Windows XP...) system with none IOAPIC HW support will cause the system to hang. Following are some situations users might run into:  
1. An IOAPIC enabled OS and change the BIOS setting from IOAPIC to PIC, this will cause your system to hang.

### ⌘ Boot Up Num-Lock

- ☑ On Keypad is number keys. (Default value)
- ☑ Off Keypad is arrow keys.

### ⌘ Floppy Drive Seek

During POST, BIOS will determine the floppy disk drive installed is 40 or 80 tracks. 360 K type is 40 tracks 720 K, 1.2 M and 1.44 M are all 80 tracks.

- ☑ Enabled BIOS searches for floppy disk drive to determine it is 40 or 80 tracks. Note that BIOS can not tell from 720 K, 1.2 M or 1.44 M drive type as they are all 80 tracks.
- ☑ Disabled BIOS will not search for the type of floppy disk drive by track number. Note that there will not be any warning message if the drive installed is 360 K. (Default value)



### ⌘ Password Check

Please refer to the detail on P.53

- ☑ Always The user must enter correct password in order to access the system and/or BIOS Setup.
- ☑ Setup The user must enter correct password in order to access BIOS setup utility. (Default Value)

### **BIOS Flash Protection**

This field lets you determine the states that flash BIOS.

-  Auto      BIOS enables flash write access automatically when updating BIOS data/DMI/ESCD. (Default Value)
-  Enabled      During POST, DMI/ESCD would not be updated. But flash tools can update BIOS always.

## Chipset Features Setup

AMBIOS SETUP - CHIPSET FEATURES SETUP	
( C ) 1999 American Megatrends, Inc. All Rights Reserved	
Top Performance	:Disabled
Fast Command	:Ultra
Configure SDRAM by SPD	:Enabled
SDRAM Frequency	:Auto
SDRAM CAS# Latency	:2
SDRAM Command Rate	:1T Command
AGP Mode	:4X
AGP Comp. Driving	:Auto
Manual AGP Comp. Driving	:DA
AGP Fast Write	:Enabled
AGP Aperture Size	:128MB
AGP Read Synchronization	:Enabled
PCI Delay Transaction	:Enabled
USB Controller	:All USB Port
USB Legacy Support	:Disabled
USB Port 64/60 Emulation	:Disabled
ESC: Quit      ↓ ↓ ↓ ↓ ↓ ↓ : Select Item F1 : Help                      PU/PD+/- : Modify F5 : Old Values                      (Shift)F2: Color F6 : Fail-Safe                      F7 : Optimized F8 : Dual BIOS/Q-Flash	

Figure 4: Chipset Features Setup

If you require more advanced BIOS settings please go to “Advanced BIOS” setting menu. To enter Advanced BIOS setting menu, press “Ctrl+F1” instead of “DEL” key during POST.

### ☞ Top Performance

- ☞ Disabled      Top Performance Disabled. (Default Value)
- ☞ Enabled      Top Performance Enabled.

### ☞ Fast Command

- ☞ Ultra      Set Fast Command to Ultra. (Default Value)
- ☞ Fast      Set Fast Command to Fast.
- ☞ Normal      Set Fast Command to Normal..

**Configure SDRAM by SPD**

- Disabled Disabled Configure SDRAM Timing by SPD.
- Enabled Enabled Configure SDRAM Timing by SPD. (Default Value)

**DRAM Frequency**

- 266MHz Set DRAM Frequency is 266MHz.
- 333MHz Set DRAM Frequency is 333MHz.
- Auto Set DRAM Frequency is Auto. (Default Value).

**SDRAM CAS# Latency**

- 2 For Fastest SDRAM DIMM module. (Default Value).
- 2.5 For Slower SDRAM DIMM module.

**SDRAM Command Rate**

- 2T Command Set SDRAM Command Rate to 2T Command.
- 1T Command Set SDRAM Command Rate to 1T Command. (Default Value)

**AGP Mode**

- 4X Set AGP Mode is 4X. (Default Value)
- 1X Set AGP Mode is 1X.
- 2X Set AGP Mode is 2X.

**AGP Comp. Driving**

- Auto Set AGP Comp. Driving is Auto. (Default Value)
- Manual Set AGP Comp. Driving is Manual.  
If AGP Comp. Driving is Manual.  
Manual AGP Comp. Driving :00~FF

**AGP Fast Write**

- Disabled Disabled AGP Fast Write
- Enabled Enabled AGP Fast Write (Default Value)

---

**AGP Aperture Size**

- 4MB Set AGP Aperture Size to 4MB.
- 8MB Set AGP Aperture Size to 8 MB.
- 16MB Set AGP Aperture Size to 16 MB.
- 32MB Set AGP Aperture Size to 32 MB.
- 64MB Set AGP Aperture Size to 64 MB.
- 128MB Set AGP Aperture Size to 128 MB. (Default Value)
- 256MB Set AGP Aperture Size to 256 MB.

**AGP Read Synchronization**

- Enabled Enable AGP Read Synchronization. (Default Value)
- Disabled Disable AGP Read Synchronization.

**PCI Delay Transaction**

- Enabled Enabled PCI Delay Transaction. (Default Value)
- Disabled Disabled PCI Delay Transaction.

**USB Controller**

- Disabled Disable USB Controller function.
- USB Port 1&2 Enabled USB Port 1&2.
- USB Port 2&3 Enabled USB Port 2&3.
- USB Port 1&3 Enabled USB Port 1&3.
- USB1 Enabled USB Port 1.
- USB2 Enabled USB Port 2.
- USB3 Enabled USB Port 3.
- All USB Port Enabled All USB Port . (Default Value)

**USB Legacy Support**

- Keyboard/FDD Set USB Legacy Support Keyboard / Floppy.
- KB/Mouse/FDD Set USB Legacy Support Keyboard / Mouse /Floppy.
- Disabled Disabled USB Legacy Support Function. (Default Value)

 **USB Port 64/60 Emulation**



- Enabled      To use USB mouse under Win NT environment, set USB Legacy Support to KB/Mouse/FDD and USB Port 64/60 Emulation to enabled.
- Disabled      Disable this Function. (Default Value)

## Power Management Setup

AMIBIOS SETUP - POWER MANAGEMENT SETUP		
( C ) 1999 American Megatrends, Inc. All Rights Reserved		
ACPI Standby State	:S1/POS	RTC Alarm Date :15
USB Dev Wakeup From S3-S5	:Disabled	RTC Alarm Hour :12
Suspend Time Out(Minute)	:Disabled	RTC Alarm Minute :30
IRQ3	:Monitor	RTC Alarm Second :30
IRQ 4	:Monitor	
IRQ 5	:Ignore	
IRQ 7	:Monitor	
IRQ 9	:Ignore	
IRQ 10	:Ignore	
IRQ 11	:Ignore	
IRQ 13	:Ignore	
IRQ 14	:Monitor	
IRQ 15	:Ignore	
Soft-off by Power Button	:Instant off	
AC Back Function	:Soft-Off	
Modem Ring On/Wake On Lan	:Enabled	ESC: Quit ↓ ↓ ↓ ↓ ↓ ↓ ↓ ↓ : Select Item
PME Event Wake Up	:Enabled	F1 : Help PU/PD+/- : Modify
Keyboard Wakeup From	:S1(Suspend)	F5 : Old Values (Shift)F2: Color
PS/2 Mouse Wakeup From	:S1(Suspend)	F6 : Fail-Safe F7 : Optimized
Resume On RTC Alarm	:Disabled	F8 : Dual BIOS/Q-Flash



Figure 5: Power Management Setup

### ACPI Standby State











-  S1/POS Set ACPI standby state is S1. (Default Value)
-  S3/STR Set ACPI standby state is S3.

### USB Dev Wakeup From S3~S5(for USB 1.1 device only)



USB Dev Wakeup From S3~S5 can be set when ACPI standby state set to S3/STR.

-  Enabled Enable USB Dev Wakeup From S3~S5.
-  Disabled Disable USB Dev Wakeup From S3~S5. (Default Value).



 **Suspend Time Out (Minute.)**

-  Disabled Disabled Suspend Time Out Function. (Default Value)
-  1 Enabled Suspend Time Out after 1min.
-  2 Enabled Suspend Time Out after 2min.
-  4 Enabled Suspend Time Out after 4min.
-  8 Enabled Suspend Time Out after 8min.
-  10 Enabled Suspend Time Out after 10min.
-  20 Enabled Suspend Time Out after 20min.
-  30 Enabled Suspend Time Out after 30min.
-  40 Enabled Suspend Time Out after 40min.
-  50 Enabled Suspend Time Out after 50min.
-  60 Enabled Suspend Time Out after 60min.



 **IRQ 3~IRQ15**

-  Ignore Ignore IRQ3~IRQ15.
-  Monitor Monitor IRQ3~IRQ15.

 **Soft-off by Power Button**

-  Instant-off Soft switch ON/OFF for POWER ON/OFF. (Default Value)
-  Delay 4 sec Soft switch on 4sec for power OFF.

 **AC Back Function**

-  Soft-Off When AC-power back to the system, the system will be in "Soft-Off" state. (Default Value)
-  Full-On When AC-power back to the system, the system will be in "Full-On" state.
-  Memory When AC-power back to the system, the system will return to the Last state before AC-power off.



⌘ **Modem Ring On/Wake On LAN**

- ⌘ Disabled      Disabled Resume On Ring / LAN.
- ⌘ Enabled      Enabled Resume On Ring / LAN. (Default Value)

⌘ **PME Event Wake Up**

- ⌘ Disabled      Disable PME Event Wake Up.
- ⌘ Enabled      Enabled PME Event Wake Up. (Default Value)

⌘ **Keyboard Wakeup From**

- ⌘ S1(Suspend)    Keyboard is able to Wakeup the system from S1(Suspend) state.  
(Default value)
- ⌘ S1/S3          Keyboard is able to Wakeup the system from S1/S3 state.
- ⌘ S1/S3/S4/S5    Keyboard is able to Wakeup the system from S1/S3/S4/S5 state.

⌘ **PS/2 Mouse Wakeup From**

- ⌘ S1(Suspend)    PS/2 Mouse is able to Wakeup the system from S1(Suspend) state.  
(Default value)
- ⌘ S1/S3          PS/2 Mouse is able to Wakeup the system from S1/S3 state.
- ⌘ S1/S3/S4/S5    PS/2 Mouse is able to Wakeup the system from S1/S3/S4/S5 state.

⌘ **Resume On RTC Alarm**

You can set "RTC Alarm Power On" item to enabled and key in Data/time to power on system.

- ⌘ Disabled      Disable this function. (Default Value)
- ⌘ Enabled      Enable alarm function to POWER ON system.

If RTC Alarm Lead To Power On is Enabled.

RTC Alarm Date:Everyday , 1~31

RTC Alarm Hour:0~23

RTC Alarm Minute : 0~59

RTC Alarm Second:0~59

## PNP/PCI Configuration

AMIBIOS SETUP - PNP/PCI CONFIGURATION	
( C ) 1999 American Megatrends, Inc. All Rights Reserved	
VGA Boot From	: AGP
PCI Slot 1/5 IRQ Priority	: Auto
PCI Slot 2 IRQ Priority	: Auto
PCI Slot 3 IRQ Priority	: Auto
PCI Slot 4 IRQ Priority	: Auto
ESC: Quit    ↵ ↵ ↵ ↵ ↵ ↵ ↵ : Select Item F1 : Help                      PU/PD+/- : Modify F5 : Old Values                (Shift)F2: Color F6 : Fail-Safe                 F7 : Optimized F8 :Dual BIOS/Q-Flash	





Figure 6: PNP/PCI Configuration

### 🔍 VGA Boot From

- AGP              Set VGA Boot from AGP VGA Card. (Default Value)
- PCI                 Set VGA Boot from PCI VGA Card.

### 🔍 PCISlot1/5, 2, 3, 4 IRQ Priority

- Auto                The system will reserved a free IRQ for PCI slot 1/5, 2, 3, 4 device. (Default Value)
- 3                    The system will reserved IRQ3 for PCI slot 1/5, 2, 3, 4device if no legacy ISA device using IRQ3.
- 4                    The system will reserved IRQ for PCI slot 1/5, 2, 3, 4 device if no legacy ISA device using IRQ4.
- 5                    The system will reserved IRQ5 for PCI slot 1/5, 2, 3, 4device if no legacy ISA device using IRQ5.

- 7      The system will reserved IRQ7 for PCI slot 1/5, 2, 3, 4 device if no legacy ISA device using IRQ7.
- 9      The system will reserved IRQ9 for PCI slot 1/5, 2, 3, 4 device if no legacy ISA device using IRQ9.
- 10     The system will reserved IRQ10 for PCI slot 1/5, 2, 3, 4 device if no legacy ISA device using IRQ10.
- 11     The system will reserved IRQ11 for PCI slot 1/5, 2, 3, 4 device if no legacy ISA device using IRQ11.

## Load Fail-Safe Defaults

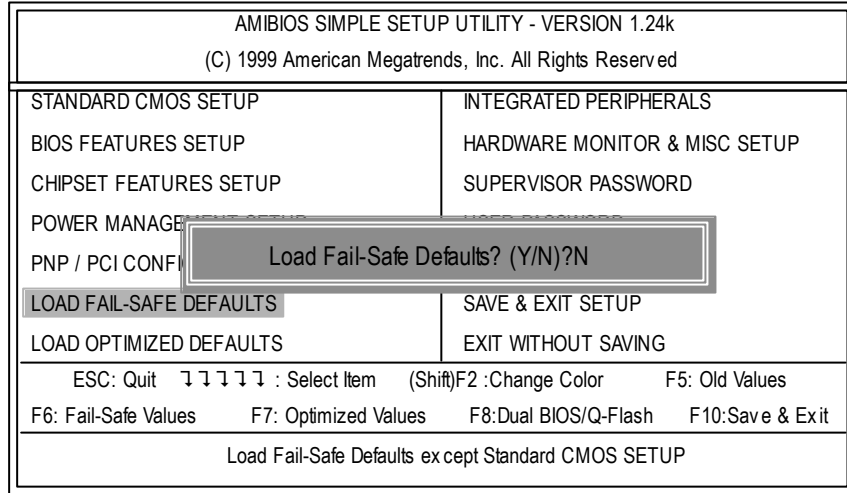

Figure 7: Load Fail-Safe Defaults

### Load Fail-Safe Defaults

Fail-Safe defaults contain the most appropriate system parameter values of to configure the system to achieve maximum stability.

## Load Optimized Defaults

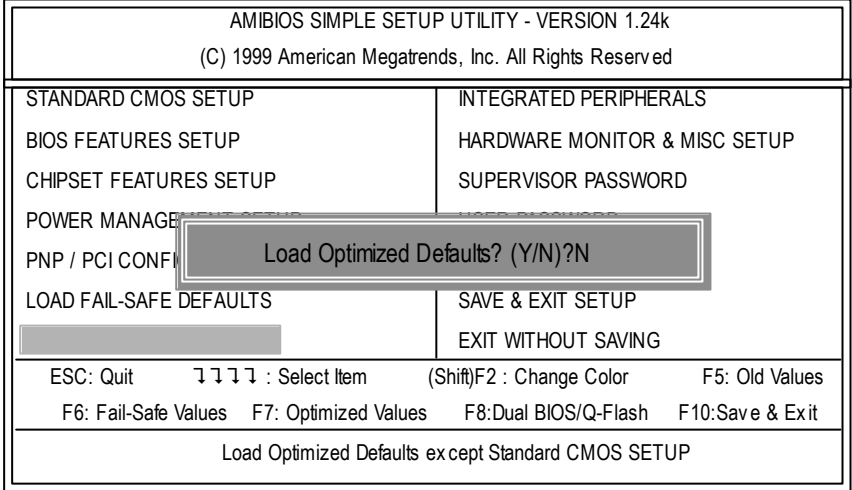

Figure 8: Load Optimized Defaults

### **Load Optimized Defaults**

Optimized defaults contain the most appropriate system parameter values to configure the system to achieve maximum performance.

## Integrated Peripherals

AMIBIOS SETUP - INTEGRATED PERIPHERALS	
( C ) 1999 American Megatrends, Inc. All Rights Reserved	
OnBoard FDC	:Auto
OnBoard Serial Port 1	:Auto
OnBoard Serial Port 2	:Auto
Serial Port2 Mode	:Normal
OnBoard Parallel Port	:Auto
Parallel Port Mode	:ECP
Parallel Port IRQ	:Auto
Parallel Port DMA	:Auto
OnBoard MIDI Port	:300
OnBoard Game Port	:Enabled
OnBoard SC Interface*	:Disabled
OnBoard MS/SD Interface*	:Memory Stick
OnBoard IDE	:Both
OnBoard Sound Chip*	:Enabled
OnBoard LAN Chip*	:Enabled
OnBoard USB 2.0 Chip	:Enabled
OnBoard PROMISE Chip*	:ATA
ESC : Quit                    ↓ ↓ ↓ ↓ ↓ : Select Item F1 : Help                    PU/PD+/- : Modify F5 : Old Values                (Shift)F2: Color F6 : Fail-Safe                 F7 : Optimized F8 : Dual BIOS/Q-Flash	

Figure 9: Integrated Peripherals

### ☞ On Board FDC

- ☞ Auto            Set On Board FDC is Auto (Default Value).
- ☞ Disabled        Disabled On Board FDC
- ☞ Enabled         Enabled On Board FDC

\*\*\* For GA-7VRXP Only.

---

**Onboard Serial Port 1**

- Auto BIOS will automatically setup the port 1 address (Default Value).
- 3F8/COM1 Enable onboard Serial port 1 and address is 3F8.
- 2F8/COM2 Enable onboard Serial port 1 and address is 2F8.
- 3E8/COM3 Enable onboard Serial port 1 and address is 3E8.
- 2E8/COM4 Enable onboard Serial port 1 and address is 2E8.
- Disabled Disable onboard Serial port 1.

**Onboard Serial Port 2**

- Auto BIOS will automatically setup the port 2 address (Default Value).
- 3F8/COM1 Enable onboard Serial port 2 and address is 3F8.
- 2F8/COM2 Enable onboard Serial port 2 and address is 2F8.
- 3E8/COM3 Enable onboard Serial port 2 and address is 3E8.
- 2E8/COM4 Enable onboard Serial port 2 and address is 2E8.
- Disabled Disable onboard Serial port 2.

**Serial Port 2 Mode**





- Normal Normal operation. (Default Value)
- IrDA Onboard I/O chip supports IrDA
- ASK IR Onboard I/O chip supports ASK IR.
- SCR Onboard I/O chip supports SCR.

SCR option is shown only when there's SCR hardware function is installed.



**OnBoard Parallel port**

- 378 Enable On Board LPT port and address is 378.
- 278 Enable On Board LPT port and address is 278.
- 3BC Enable On Board LPT port and address is 3BC.
- Auto Set On Board LPT port is Auto. (Default Value)
- Disabled Disable On Board LPT port.





#### **Parallel Port Mode**

-  EPP Using Parallel port as Enhanced Parallel Port.
-  ECP Using Parallel port as Extended Capabilities Port. (Default Value)
-  Normal Normal Operation.
-  EPP+ECP Using Parallel port as Enhanced Parallel Port & Extended Capabilities Port.





#### **Parallel Port IRQ**

-  7 Set Parallel Port IRQ is 7.
-  Auto Set Auto to parallel Port IRQ DMA Channel. (Default Value).
-  5 Set Parallel Port IRQ is 5.



#### **Parallel Port DMA**

-  Auto Set Auto to parallel port mode DMA Channel. (Default Value).
-  3 Set Parallel Port DMA is 3.
-  1 Set Parallel Port DMA is 1.
-  0 Set Parallel Port DMA is 0.

#### **OnBoard MIDI Port**

-  300 Set 300 for MIDI Port. (Default Value)
-  310 Set 310 for MIDI Port .
-  320 Set 320 for MIDI Port.
-  330 Set 330 for MIDI Port.
-  Disabled Disabled this function.

#### **OnBoard Game Port**

-  Enabled Enabled onBoard Game Port. (Default Value)
-  Disabled Disabled onBoard Game Port.



---

**OnBoard SC Interface\***

- Enabled Enabled onBoard SC Interface.
- Disabled Disabled onBoard SC Interface.(Default Value)

**OnBoard MS/SD Interface\***

- Memory Stick Set MS/SD Interface to Memory Stick.(Default value)
- Secure Digital Set MS/SD Interface to Secure Digital.
- Disabled Disabled MS/SD Interface.

**OnBoard IDE**

- Disabled Disabled OnBoard IDE
- Both Set OnBoard IDE is Both (Default Value).
- Primary Set OnBoard IDE is Primary
- Secondary Set OnBoard IDE is Secondary

**Onboard Sound Chip\***

- Enable Enable onboard Sound function.(Default value)
- Disable Disable onboard Sound function.

**OnBoard Lan Chip\***

- Enabled Enabled OnBoard Lan Chip. (Default Value)
- Disabled Disabled OnBoard Lan Chip.

If “OnBoard SC Interface” is set to “Enabled” and “OnBoard MS/SD Interface” set to “Memory Stick” at the same time, there will not be enough IRQ resource to solve this issue, there are two alternative solutions:

- 1.Use USB Mouse instead of PS/2 Mouse.
- 2.Disabled either “Onboard Serial Port1” , “Onboard Serial Port2” or “Onboard Parallel Port” in BIOS setting.

**\*\*\* For GA-7VRXP Only.**

☞ **Onboard USB 2.0 Device**

- ☞ Enable      Enable onboard USB 2.0 Device.(Default value)
- ☞ Disable     Disable onboard USB 2.0 Device.

☞ **Onboard PROMISE Chip\***

- ☞ RAID        Enable onboard RAID Device.
- ☞ ATA         Enable onboard ATA Device.(Default value)
- ☞ Disable     Disable onboard ATA/RAID Device.

\*\*\* For GA-7VRXP Only.





---

## Hardware Monitor & MISC Setup





AMIBIOS SETUP - HARDWARE MONITOR & MISC SETUP	
( C ) 1999 American Megatrends, Inc. All Rights Reserved	
AGP Voltage	:1.5V
DDR Voltage	:2.5V
VCore Voltage	:Normal
CPU Host Clock (Mhz)	:By Hw
#Reset Case Open Status	:No
#Case Status	:Open
CPU Temp.	: 35°C/ 95°F
System Temp.	: 33°C/ 91°F
CPU Fan Speed	: 5273 RPM
System Fan Speed	: 0 RPM
Vcore	: +1.632V
Vtt	: +3.344V
+3.300V	: +3.296V
+5.000V	: +5.080V
+12.000V	: +11.840V
5V SB	: +4.972V
F1 : Help                      PU/PD+/- : Modify F5 : Old Values                (Shift)F2: Color F6 : Fail-Safe                 F7 : Optimized F8 : Dual BIOS/Q-Flash	

Figure 10: Hardware Monitor & MISC Setup

### AGP Voltage

-  1.5V            Set AGP voltage to 1.5V. (Default Value)
-  1.6V            Set AGP voltage to 1.6V.
-  1.7V            Set AGP voltage to 1.7V.
-  1.8V            Set AGP voltage to 1.8V.

### DDR Voltage

-  2.5V            Set DDR voltage to 2.5V. (Default Value)
-  2.6V            Set DDR voltage to 2.6V.
-  2.7V            Set DDR voltage to 2.7V.
-  2.8V            Set DDR voltage to 2.8V.

"#" Only for GA-7VRX/GA-7VRXP PCB Ver.1.1 use.

☞ **VCore Voltage**

- ☞ Normal Normal Function.(Default Value)
- ☞ +5.0% Set VCore voltage to +5.0% .
- ☞ +7.5% Set VCore voltage to +7.5% .
- ☞ +10.0% Set VCore voltage to +10.0% .

☞ **CPU Host Clock (Mhz)**

- ☞ By Hw Set CPU Host Clock by Hw. (Default Value)
- ☞ 133 Set CPU Host Clock to 133MHz~161MHz.
- ☞ 100 Set CPU Host Clock to 100Mhz~128MHz.

#☞ **Reset Case Open Status**

#☞ **Case S tatus**

If the case is closed, "Case Opened" will show "No".  
If the case have been opened, "Case Opened" will show "Yes".  
If you want to reset "Case Opened" value, set "Reset Case Open Status" to "Yes" and save CMOS, your computer will restart.

☞ **CPU / System Temp.**

- ☞ Detect CPU / SystemTemperature automatically.

☞ **CPU / System FAN Speed**

- ☞ Detect CPU / System Fan speed status automatically .

☞ **Current Voltage (V) VCORE / Vtt / +3.3V / +12V / +5V / 5VSB**

- ☞ Detect system's voltage status automatically.

"#" Only for GA-7VRX/GA-7VRXP PCB Ver.1.1 use.

## Set Supervisor / User Password

When you select this function, the following message will appear at the center of the screen to assist you in creating a password.

AMIBIOS SIMPLE SETUP UTILITY - VERSION 1.24k (C) 1999 American Megatrends, Inc. All Rights Reserved	
STANDARD CMOS SETUP	INTEGRATED PERIPHERALS
BIOS FEATURES SETUP	HARDWARE MONITOR & MISC SETUP
CHIPSET FEATURES SETUP	<b>SUPERVISOR PASSWORD</b>
POWER MANAGEMENT	Enter new supervisor password:
PNP / PCI CONFIGURATION	
LOAD FAIL-SAFE DEFAULTS	SAVE & EXIT SETUP
LOAD OPTIMIZED DEFAULTS	EXIT WITHOUT SAVING
ESC: Quit    ↑ ↓ ← →: Select Item    (Shift)F2: Change Color    F5: Old Values F6: Fail-Safe Values    F7: Optimized Values    F8: Dual BIOS/Q-Flash    F10: Save & Exit	
Change / Set / Disable Password	

Figure 11: Password Setting

Type the password, up to six characters, and press <Enter>. You will be asked to confirm the password. Type the password again and press <Enter>. You may also press <Esc> to abort the selection and not enter a password.

To disable password, just press <Enter> when you are prompted to enter password. A message "PASSWORD DISABLED" will appear to confirm the password being disabled. Once the password is disabled, the system will boot and you can enter Setup freely.

The BIOS Setup program allows you to specify two separate passwords: a SUPERVISOR PASSWORD and a USER PASSWORD. When disabled, anyone may access all BIOS Setup program function. When enabled, the Supervisor password is required for entering the BIOS Setup program and having full configuration fields, the User password is required to access only basic items.

If you select "Always" at "Password Check" in BIOS Features Setup Menu, you will be prompted for the password every time the system is rebooted or any time you try to enter Setup Menu.

If you select "Setup" at "Password Check" in BIOS Features Setup Menu, you will be prompted only when you try to enter Setup.

## IDE HDD Auto Detection

AMIBIOS SETUP - STANDARD CMOS SETUP	
( C ) 1999 American Megatrends, Inc. All Rights Reserved	
Date (mm/dd/yyyy) : Fri Mar 16, 2001	
Time (hh/mm/ss) : 14:44:35	
TYPE SIZE CYLS HEAD PRECOMP LANDZ SECTOR MODE	
Pri Master : Auto	
Pri Slave : Auto	
Sec Master : Auto	
Sec Slave : Auto	
Floppy Drive A : 1.44 MB 3 <sup>1/2</sup>	Base Memory : 640 Kb
Floppy Drive B : Not Installed	Other Memory : 384 Kb
Boot Sector Virus Protection : Disabled	Extended Memory : 255 Mb
	Total Memory : 256 Mb
Month : Jan - Dec	ESC : Exit
Day : 01- 31	↓↑↓ : Select Item
Year : 1990 - 2099	PU / PD / + / - : Modify
	(Shift) F2 : Color

Figure 12: IDE HDD Auto Detection

Type "Y" will accept the H.D.D. parameter reported by BIOS.

Type "N" will keep the old H.D.D. parameter setup. If the hard disk cylinder number is over 1024, then the user can select LBA mode or LARGER mode for DOS partition larger than 528 MB.

## Save & Exit Setup

AMIBIOS SIMPLE SETUP UTILITY - VERSION 1.24k (C) 1999 American Megatrends, Inc. All Rights Reserved	
STANDARD CMOS SETUP	INTEGRATED PERIPHERALS
BIOS FEATURES SETUP	HARDWARE MONITOR & MISC SETUP
CHIPSET FEATURES SETUP	SUPERVISOR PASSWORD
POWER MANAGEMENT SETUP	USER PASSWORD
PNP / PCI CONF	SAVE & EXIT SETUP
LOAD FAIL-SAFE DEFAULTS	EXIT WITHOUT SAVING
LOAD OPTIMIZED DEFAULTS	
ESC: Quit   ↓ ↓ ↓ ↓ ↓ ↓ : Select Item   (Shift)F2 : Change Color   F5: Old Values F6: Fail-Safe Values   F7: Optimized Values   F8: Dual BIOS/Q-Flash   F10: Save & Exit	
Save Data to CMOS & Exit SETUP	

Figure 13: Save & Exit Setup

Type "Y" will quit the Setup Utility and save the user setup value to RTC CMOS.  
 Type "N" will return to Setup Utility.

## Exit Without Saving

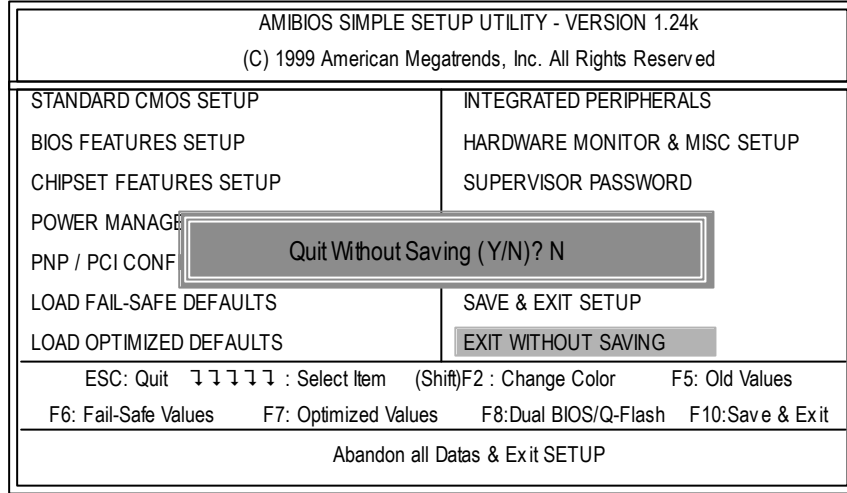

Figure 14: Exit Without Saving

Type "Y" will quit the Setup Utility without saving to RTC CMOS.

Type "N" will return to Setup Utility.



# Chapter 4 Technical Reference

## Block Diagram

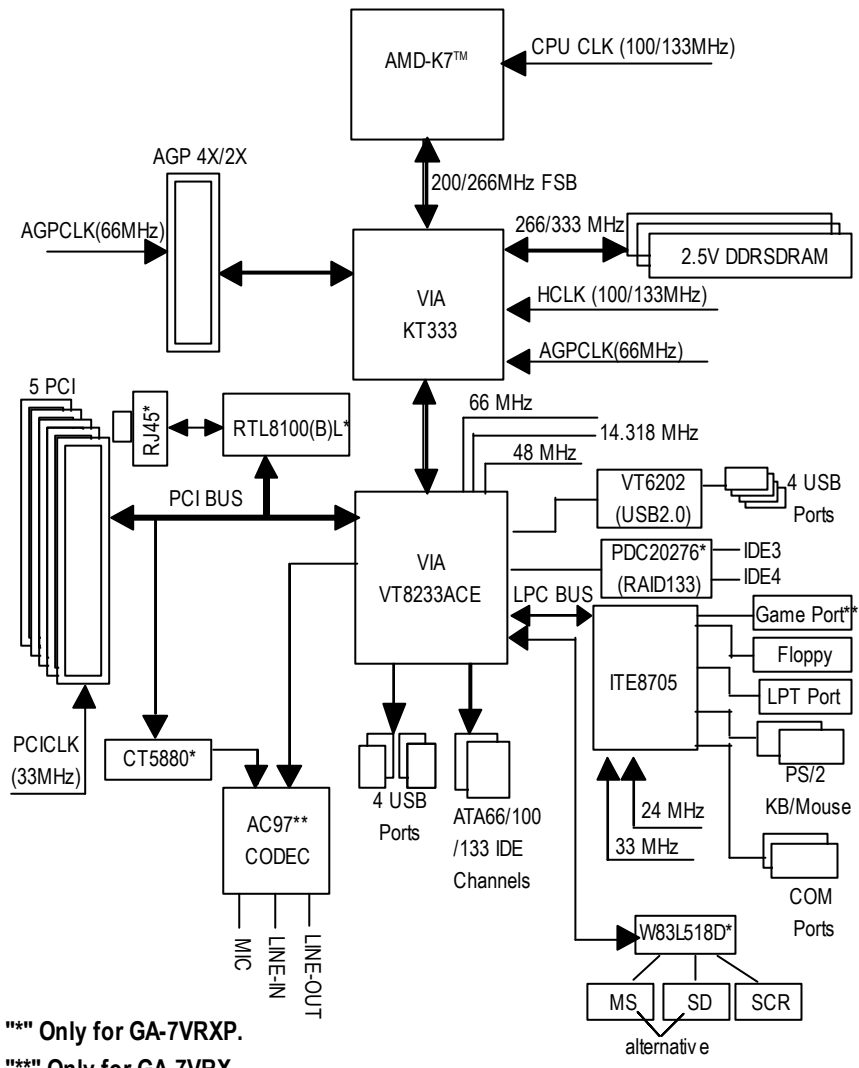

\*\*\* Only for GA-7VRXP.

\*\*\*\* Only for GA-7VRX.

## Dual BIOS & Q-Flash Utility Introduction

### A. What is Dual BIOS Technology?

Dual BIOS means that there are two system BIOS (ROM) on the motherboard, one is the Main BIOS and the other is Backup BIOS. Under the normal circumstances, the system works on the Main BIOS. If the Main BIOS is corrupted or damaged, the Backup BIOS can take over while the system is powered on. This means that your PC will still be able to run stably as if nothing has happened in your BIOS.

### B. How to use Dual BIOS and Q-Flash Utility?

#### a. Boot Screen



b. Dual BIOS Utility

Dual BIOS Utility	
Boot From.....	Main BIOS
Main ROM Type.....	SST 39SF020
Backup ROM Type.....	SST 39SF020
Wide Range Protection	Disable
Boot From	MainBIOS
Auto Recovery	Enable
Halt On Error	Disable
Copy Main ROM Data to Backup	
Load Default Settings	
Save Settings to CMOS	
Q-Flash Utility	
Load Main BIOS From Floppy	
Load Backup BIOS From Floppy	
Save Main BIOS to Floppy	
Save Backup BIOS to Floppy	
PgDn/PgUp:Modify	↵:Move
ESC:Reset	F10:Power Off

c. Dual BIOS Item explanation:

- BIOS will auto detect
- Boot From : Main BIOS
- Main ROM Type : SST 39SF020
- Backup ROM Type : SST 39SF020

**Wide Range Protection: Disable(Default), Enable**

Status 1:

If any failure (ex. Update ESCD failure, checksum error or reset...) occurs in the Main BIOS , just before the Operating System is loaded and after the power is on, and that the Wide Range Protection is set to "Enable", the PC will boot from Backup BIOS automatically .

Status 2:

If the ROM BIOS on peripherals cards(ex. SCSI Cards, LAN Cards,..) emits signals to request restart of the system after the user make any alteration on it, the boot up BIOS will not be changed to the Backup BIOS.

**Boot From : Main BIOS (Default), Backup BIOS**

Status 1:

The user can set to boot from main BIOS or Backup BIOS.

**Auto Recovery : Enabled(Default), Disabled**

When one of the Main BIOS or Backup BIOS occurs checksum failure, the working BIOS will automatically recover the BIOS of checksum failure.

(In the Power Management Setup of the BIOS Setting, if ACPI Suspend Type is set to Suspend to RAM, the Auto Recovery will be set to Enable automatically.)

(If you want to enter the BIOS setting, please press "Del" key when the boot screen appears.)

**Halt On Error : Disable(Default), Enable**

If the BIOS occurs a checksum error or the Main BIOS occurs a WIDE RANGE PROTECTION error and Halt On BIOS Defects set to Enable, the PC will show messages on the boot screen, and the system will pause and wait for the user's instruction.

If Auto Recovery: Disable, it will show <or the other key to continue.>

If Auto Recovery: Enable, it will show <or the other key to Auto Recover.>

**Copy Main ROM Data to Backup**

Backup message:

**Are you sure to copy BIOS?**

**[Enter] to continue or [Esc] to abort...**

The means that the Main BIOS works normally and could automatically recover the Backup BIOS. Or the means that the Backup BIOS works normally and could automatically recover the Main BIOS.

(This auto recovery utility is set by system automatically and can't be changed by user.)

**C. What is Q-Flash Utility?**

Q-Flash utility is a pre-O.S. BIOS flash utility enables users to update its BIOS within BIOS mode, no more fooling around any OS.

**D. How to use Q-Flash?**

**Load Main (Backup) BIOS From Floppy**

- ✍ In the A: drive, insert the "BIOS" diskette, then Press Enter to Run.
- ✍ You can use the light bar to select item. then Press "Enter".
- ✍ For Example: BIOS File name: 7VRXP.E8

Dual BIOS Utility							
Boot From.....Main BIOS							
Main ROM Type.....SST 39SF020							
Backup ROM Type.....SST 39SF020							
3 file(s) found							
<table border="1" style="width: 100%; border-collapse: collapse;"> <tr> <td style="padding: 2px;">COMMAND.COM</td> <td style="padding: 2px; text-align: right;">92.8K</td> </tr> <tr> <td style="padding: 2px;">FLASH848.EXE</td> <td style="padding: 2px; text-align: right;">472.16K</td> </tr> <tr> <td style="padding: 2px;">7VRXP.E8</td> <td style="padding: 2px; text-align: right;">256K</td> </tr> </table>	COMMAND.COM	92.8K	FLASH848.EXE	472.16K	7VRXP.E8	256K	
COMMAND.COM	92.8K						
FLASH848.EXE	472.16K						
7VRXP.E8	256K						
<table style="width: 100%;"> <tr> <td style="width: 50%;">Total size: 1.39M</td> <td style="width: 50%;">Free size:316k</td> </tr> <tr> <td>F5:Refresh</td> <td>DEL:Delete</td> </tr> </table>		Total size: 1.39M	Free size:316k	F5:Refresh	DEL:Delete		
Total size: 1.39M	Free size:316k						
F5:Refresh	DEL:Delete						
Q-Flash Utility							
Load Main BIOS From Floppy							
Load Backup BIOS From Floppy							
Save Main BIOS to Floppy							
Save Backup BIOS to Floppy							
PgDn/PgUp:Modify      ↵:Move      ESC:Reset      F10:Power Off							

**Reading BIOS file from Floppy**  
Don't Turn Off Power or RESET System...

**CHECKSUM=78B7**  
**Are you sure to update BIOS?**  
[Enter] to continue or [Esc] to abort....

**!!COPY BIOS Complete-Pass!!**

Please press any key to continue

Congratulation! You have completed the flashed and now can restart system.

**Save Main (Backup) BIOS to Floppy**

- ☞ In the A:drive, insert the "BIOS" diskette, then Press Enter to Run.
- ☞ You can use the light bar to select item. then Press "Enter".

Dual BIOS Utility

Boot From.....Main BIOS  
Main ROM Type.....SST 39SF020  
Backup ROM Type.....SST 39SF020

TYPE FILE NAME	
File name:	
3 file(s) found	
COMMAND.COM	92.8K
FLASH848.EXE	472.16K
7VRXP.E8	256K

Total size: 1.39M      Free size:316k  
F5:Refresh      DEL:Delete

Load Main BIOS From Floppy  
Load Backup BIOS From Floppy  
Save Main BIOS to Floppy  
Save Backup BIOS to Floppy

PgDn/PgUp:Modify      ↵:Move      ESC:Reset      F10:Power Off

**Saving BIOS to floppy**

Don't Turn Off Power or RESET System...



## DualBIOS™ Technology FAQ

GIGABYTE Technology is pleased to introduce DualBIOS technology, a hot spare for your system BIOS. This newest "Value-added" feature, in a long series of innovations from GIGABYTE, is available on this motherboard. Future GIGABYTE motherboards will also incorporate this innovation.

### **What's DualBIOS™?**

On GIGABYTE motherboards with DualBIOS there are physically two BIOS chips. For simplicity we'll call one your "Main BIOS" and the other we'll call your "Backup" BIOS (your "hot spare"). If your Main BIOS fails, the Backup BIOS almost automatically takes over on your next system boot. Almost automatically and with virtually zero down time! Whether the problem is a failure in flashing your BIOS or a virus or a catastrophic failure of the Main BIOS chip, the result is the same - the Backup BIOS backs you up, almost automatically.

**I. Q: What is DualBIOS™ technology?**

**Answer:**

DualBIOS technology is a patented technology from Giga-Byte Technology. The concept of this technology is based on the redundancy and fault tolerance theory. DualBIOS™ technology simply means there are two system BIOSes (ROM) integrated onto the motherboard. One is a main BIOS, and the other is a backup BIOS. The mainboard will operate normally with the main BIOS, however, if the main BIOS is corrupt or damaged for various reasons, the backup BIOS will be automatically used when the system powered-On. Your PC will operate as before the main BIOS was damaged, and is completely transparent to the user.

**II. Q: Why does anyone need a motherboard with DualBIOS™ technology?**

**Answer:**

In today's systems there are more and more BIOS failures. The most common reasons are virus attacks, BIOS upgrade failures, and/or deterioration of the BIOS (ROM) chip itself.

1. New computer viruses are being found that attack and destroy the system BIOS. They may corrupt your BIOS code, causing your PC to be unstable or even not boot normally.
2. BIOS data will be corrupted if a power loss/surge occurs, or if a user resets the system, or if the power button is pressed during the process of performing a system BIOS upgrade.
3. If a user mistakenly updates their mainboard with the incorrect BIOS file, then the system may not be able to boot correctly. This may cause the PC system hang in operation or during boot.
4. A flash ROM's life cycle is limited according to electronic characteristics. The modern PC utilizes the Plug and Play BIOS, and is updated regularly. If a user changes peripherals often, there is a slight chance of damage to the flash ROM.

With Giga-Byte Technology's patented DualBIOS™ technology you can reduce the possibility of hangs during system boot up, and/or loss BIOS data due to above reasons. This new technology will eliminate valuable system down time and costly repair bills cause by BIOS failures.



### **III. Q: How does DualBIOS™ technology work?**

**Answer:**

1. DualBIOS™ technology provides a wide range of protection during the boot up procedure. It protects your BIOS during system POST, ESCD update, and even all the way to PNP detection/assignment.
2. DualBIOS™ provides automatic recovery for the BIOS. When the first BIOS used during boot up does not complete or if a BIOS checksum error occurs, boot-up is still possible. In the DualBIOS™ utility, the "Auto Recovery" option will guarantee that if either the main BIOS or backup BIOS is corrupted, the DualBIOS™ technology will use the good BIOS and correct the wrong BIOS automatically.
3. DualBIOS™ provides manual recovery for the BIOS. DualBIOS™ technology contains a built-in flash utility, which can flash your system BIOS from backup to main and/or visa versa. There is no need for an OS-dependent flash utility program.
4. DualBIOS™ contains a one-way flash utility. The built-in one-way flash utility will ensure that the corrupt BIOS is not mistaken as the good BIOS during recovery and that the correct BIOS (main v.s. backup) will be flashed. This will prevent the good BIOS from being flashed.

### **IV. Q: Who Needs DualBIOS™ technology?**

**Answer:**

1. Every user should have DualBIOS™ technology due to the advancement of computer viruses.  
Everyday, there are new BIOS-type viruses discovered that will destroy your system BIOS. Most commercial products on the market do not have solutions to guard against this type of virus intrusion. The DualBIOS™ technology will provide a state-of-the-art solution to protect your PC:  
Case I.) Vicious computer viruses may wipe out your entire system BIOS. With a conventional single system BIOS PC, the PC will not be functional until it is sent for repairs.  
Case II.) If the "Auto Recovery" option is enabled in the DualBIOS™ utility, and if a virus corrupts your system BIOS, the backup BIOS will automatically reboot the system and correct the main BIOS.  
Case III.) A user may override booting from the main system BIOS. The DualBIOS™ utility may be entered to manually change the boot sequence to boot from the backup BIOS.

2. During or after a BIOS upgrade, if DualBIOS™ detects that the main BIOS is corrupt, the backup BIOS will take over the boot-up process automatically. Moreover, it will verify the main and backup BIOS checksums when booting-up. DualBIOS™ technology examines the checksum of the main and backup BIOS while the system is powered on to guarantee your BIOS operates properly.
3. Power Users will have the advantage of having two BIOS versions on their mainboard. The benefit is being able to select either version BIOS to suit the performance system needs.
4. Flexibility for high-end desktop PCs and workstation/servers. In the DualBIOS™ utility, the option can be set, "Halt On When BIOS Defects," to be enabled to halt your system with a warning message that the main BIOS has been corrupted. Most workstation/servers require constant operation to guarantee services have not been interrupted. In this situation, the "Halt On When BIOS Defects" message may be disabled to avoid system pauses during normal booting. Another advantage you gain from Giga-Byte's DualBIOS™ technology is the ability to upgrade from dual 2 Mbit BIOS to dual 4 Mbit BIOS in the future if extra BIOS storage is need.

## SPDIF Introduction (For GA-7VRXP Only)

### SPDIF Introduction

#### A. What is SPDIF?

The SPDIF output is capable of providing digital signal to AC3 decoder which can support upto 5.1 speakers.

#### B. How to use SPDIF?

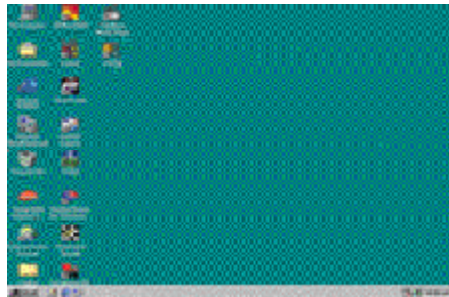

Click your mouse right button in "My Computer" and select the "Properties" item.

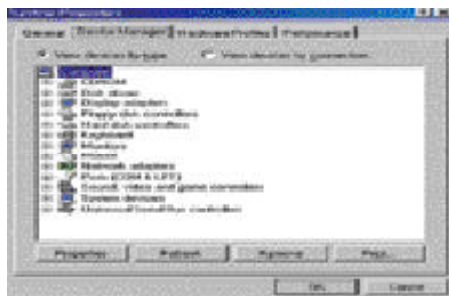

Click "Device Manager" item.

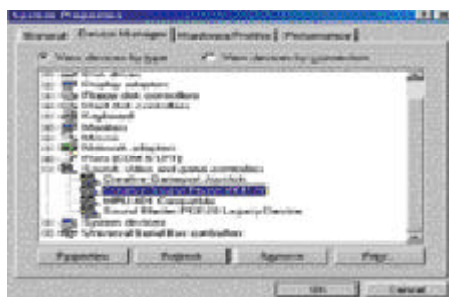

Click "Sound, video and game controllers" item and select the "Creative Sound Blaster PC1128" item.

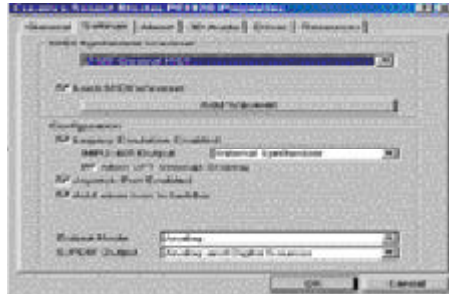

Click "Settings" item and select the "Output Mode" item.

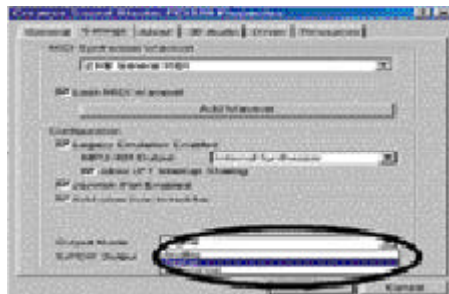

Click "Digital" item, Line Out will be reconfigure to SPDIF Out.

Recommend you to select "Autosense", It will automatically detect the type (mono or stereo) of the audio connector that you plug into Line Out audio jack, then configure Line Out to either SPDIF or Speaker accordingly.

## @ BIOS Introduction

### **Gigabyte announces @ BIOS Windows BIOS live update utility**



Have you ever updated BIOS by yourself? Or like many other people, you just know what BIOS is, but always hesitate to update it? Because you think updating newest BIOS is unnecessary and actually you don't know how to update it.

Maybe not like others, you are very experienced in BIOS updating and spend quite a lot of time to do it. But of course you don't like to do it too much. First, download different BIOS from website and then switch the operating system to DOS mode. Secondly, use different flash utility to update BIOS. The above process is not a interesting job. Besides, always be carefully to store the BIOS source code correctly in your disks as if you update the wrong BIOS, it will be a nightmare.

Certainly, you wonder why motherboard vendors could not just do something right to save your time and effort and save you from the lousy BIOS updating work? Here it comes! Now Gigabyte announces @BIOS—the first Windows BIOS live update utility. This is a smart BIOS update software. It could help you to download the BIOS from internet and update it. Not like the other BIOS update software, it's a Windows utility. With the help of "@BIOS", BIOS updating is no more than a click.

Besides, no matter which mainboard you are using, if it's a Gigabyte's product\*, @BIOS help you to maintain the BIOS. This utility could detect your correct mainboard model and help you to choose the BIOS accordingly. It then downloads the BIOS from the nearest Gigabyte ftp site automatically. There are several different choices; you could use "Internet Update" to download and update your BIOS directly. Or you may want to keep a backup for your current BIOS, just choose "Save Current BIOS" to save it first. You make a wise choice to use Gigabyte, and @BIOS update your BIOS smartly. You are now worry free from updating wrong BIOS, and capable to maintain and manage your BIOS easily. Again, Gigabyte's innovative product erects a milestone in mainboard industries.

For such a wonderful software, how much it costs? Impossible! It's free! Now, if you buy a Gigabyte's motherboard, you could find this amazing software in the attached driver CD. But please remember, connected to internet at first, then you could have a internet BIOS update from your Gigabyte @BIOS.

## Easy TuneIII™ Introduction

### **Gigabyte announces EasyTuneIII Windows overdrive utility**



“Overdrive” might be one of the most common issues in computer field. But have many users ever tried it? The answer is probably “no”. Because “overdrive” is thought to be very difficult and includes a lot of technical know-how, sometimes “over-

drive” is even considered as special skills found only in some enthusiasts.

But as to the experts in “overdrive”, what’s the truth? They may spend quite a lot of time and money to study, try and use many different hardware and software tools to do “overdrive”. And even with these technologies, they still learn that it’s quite a risk because the safety and stability of an “overdrive” system is unknown.

Now everything is different because of a Windows overdrive utility Easy TuneIII—announced by Gigabyte. This utility has totally changed the gaming rule of “overdrive”. This is the first overdrive utility suitable for both normal and power users. Users can choose either “Easy Mode” or “Advanced Mode” to run “overdrive” at their convenience. For users who choose “Easy Mode”, they just need to click “Auto Optimize” to have auto and immediate CPU overclocking. This software will then overdrive CPU speed automatically with the result being shown in the control panel. If someone prefers to “overdrive” by oneself, there is also another choice. Click “Advanced Mode” to enjoy “sport drive” class overclocking. In “Advanced Mode”, one can change the system bus speed in small increments to get ultimate system performance. And no matter which motherboard is used, if it’s a Gigabyte’s product, Easy TuneIII helps to perform the best of system.

Besides, different from other traditional over-clocking methods, Easy TuneIII doesn’t require users to change neither BIOS nor hardware switch/ jumper setting; on the other hand, they can do “overdrive” at only one click. Therefore, this is a safer way for “overdrive” as nothing is changed on software or hardware. If user runs Easy TuneIII over system’s limitation, the biggest lost is only to restart the computer again and the side effect is then well controlled. Moreover, if one well-performed system speed been tested in Easy TuneIII, user can “Save” this bus speed and “Load” it in next time. Obviously, Gigabyte Easy TuneIII has already turned the “overdrive” technology toward to a newer generation.

This wonderful software is now free bundled in Gigabyte motherboard attached driver C D. Users may make a test drive of “Easy TuneIII” to find out more amazing features by themselves.

## RAID Introduction

### What is RAID?

This motherboard implements two different types of RAID levels as follows:

#### RAID 0 (stripe)

For capacity -- The motherboard array will be as big as the smallest HDD in the array times however many HDDs are in the array. Any larger HDDs will simply be truncated. The truncated space on the bigger HDDs will then be unusable.

For sustained data transfers -- A RAID 0 array consisting of two HDDs will transfer at about twice the speed of the slowest HDD in the array. A RAID 0 array consisting of four HDDs will transfer at about three times the speed of the slowest HDD in the array.

#### RAID 1 (mirror)

For capacity - This Motherboard array will be as big as the smallest HDD in the array. The larger HDD will simply be truncated. The truncated space on the bigger HDD will then be unusable.

For sustained data transfers -- This motherboard array will write data at the rate of the slowest HDD in the array. This motherboard array will read data at twice the rate of the slowest HDD in the array.

## About RAID Levels

### Striping (RAID 0)

Reads and writes sectors of data interleaved between multiple drives. When any disk member fails, it affects the entire array. Performance is better than a single drive since the workload is balanced between the array members. This array type is for high performance systems. Identical drives are recommended for performance as well as data storage efficiency. The disk array data capacity is equal to the number of drive members times the smallest member capacity. For example, one 1GB and 1 drives will form a 2GB (2 x 1GB) disk array.

Stripe Size - a value can be set from 1KB to 1024KB sector size. The size can directly affect performance. In the FastBuild BIOS, the "Desktop" default is 8KB while "Server" and "A/V Editing" are 64KB.

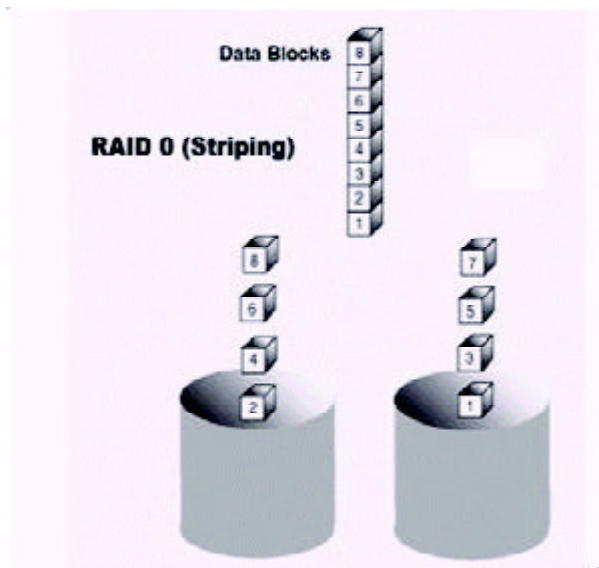



### Mirroring (RAID 1)

Writes duplicate data on to a pair of drives while reads are performed in parallel. ATA RAID 1 is fault tolerant because each drive of a mirrored pair is installed on separate IDE channels. If one of the mirrored drives suffers a mechanical failure (e.g. spindle failure) or does not respond, the remaining drive will continue to function. This is called Fault Tolerance. If one drive has a physical sector error, the mirrored drive will continue to function.

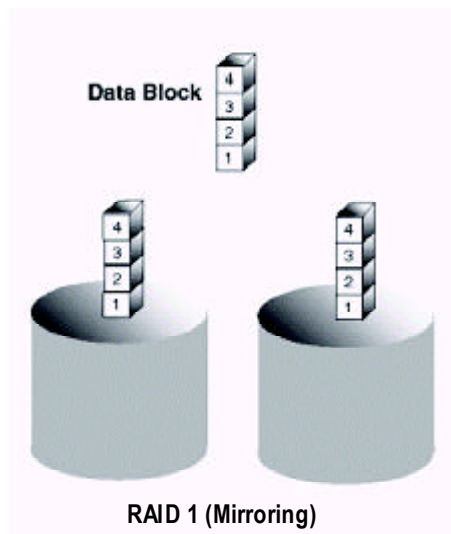

On the next reboot, the FastBuild™ utility will display an error in the array and recommend to replace the failed drive. Users may choose to continue using their PC, however Promise recommends replacing the failed drive as soon as possible. See Chapter 4 for a functional description.

Due to redundancy, the drive capacity of the array is half the total drive capacity. For example, two 1GB drives that have a combined capacity of 2GB would have 1GB of usable storage. With drives of different capacities, there may be unused capacity on the larger drive.

### Creating Your Disk Array

You will now use the FastBuild BIOS utility to create your array using the attached drives. There are two different scenarios in creating this array. You can create an array for performance, you can create a Security array using new hard drives (recommended).



**WARNING:** If creating a Security array using an existing hard drive, backup any necessary data. Failure to follow this accepted PC practice could result in data loss.

1. Boot your system. If this is the first time you have booted with RAID, the FastBuild BIOS will display the following screen.

```
FastTrak100 (tm) "Lite" BIOS Version 1.xx (Build xxxx)
(c) 1995-2001 Promise Technology, Inc. All Rights Reserved.
    No array defined . . .
Press <Ctrl-F> to enter FastBuild (tm) Utility
Or press <ESC> key to continue booting the system.
```

2. Press <Ctrl-F> keys to display the FastBuild (tm) Utility Main Menu
3. Press "1" to display the Auto Setup Menu below. This is the fastest and easiest method to creating your first array.

```
FastBuild (tm) Utility 1.32 (c) 1995-2001 Promise Technology, Inc.
    [Auto Setup Options Menu]
Optimize Array for:           Performance
Typical Application usage:    DESK TOP
    [ Auto Setup Configuration ]
Mode.....Stripe
Spare Driver.....0
Drives used in Array.....2
Array Disk Capacity (Size in MB).....160107
    [ Keys Available ]
[↑] Up [↓] Down [↵, ↶, ↷, Space] Change Option [ESC] Exit [Ctrl-Y] Save
```

### Creating an Array for Performance

NOTE: This motherboard allows users to create striped arrays with 1, 2 drives.

To create an array for best performance, follow these steps:

1. Using the Spacebar, choose "Performance" under the Optimize Array for section.
2. Select how you will use your PC most under the Typical Application usage section. The choices are A/V Editing, Server, and Desktop (the default).
3. Press <Ctrl-Y> keys to Save and create the array.
4. Reboot your system.
5. Once the array has been created, you will need to FDISK and format the array as if it were a new single hard drive.
6. Proceed to Installing Drivers section of the manual (see RAID Manual of the IUCD).

### Creating a Security Array With New Drives

NOTE: This motherboard permit only two drives to be used for a single Mirrored array in Auto Setup.

To create an array for data protection using new hard drives, follow these steps:

1. Using the Spacebar, choose "Security" under the Optimize Array for section.
2. Press <Ctrl-Y> keys to Save your selection.
3. The window below will appear.

Do you want the disk image to be duplicated to another? (Yes/No)  
 Y - Create and Duplicate  
 N - Create Only

4. Press "N" for the Create Only option.
5. A window will appear almost immediately confirming that your Security array has been created. Press any key to reboot the system

Array has been created.  
 <Press Any Key to Reboot>

6. Proceed with normal FDISK and format procedures as if you had just installed a new hard drive.
7. Once the arrayed drives have been formatted, proceed to the Installing Driver chapter (see RAID Manual of the IUCD) to install your operating system.

### Creating a Security Array With An Existing Data Drive

NOTE: This motherboard permits only two drives to be used for a single Mirrored array in Auto Setup.

You would use this method if you wish to use a drive that already contains data and/or is the bootable system drive in your system. You will need another drive of identical or larger storage capacity.



WARNING: Backup any necessary data before proceeding. Failure to follow this accepted PC practice could result in data loss.



WARNING: If you wish to include your current bootable drive using the Windows NT 4.x or Windows 2000 operating system as part of a bootable Mirrored (RAID 1) array on your system, do NOT connect the hard drive to the motherboard controller yet. You MUST install the Windows NT4 or 2000 driver software first (see RAID Manual of the IUCD) to this drive while it is still attached to your existing hard drive controller. For all other Operating Systems, proceed here.

Follow these steps:

1. Using the Spacebar, choose "Security" under the Optimize Array for section.
2. Press <Ctrl-Y> keys to Save your selection. The window below will appear.

```
Do you want the disk image to be duplicated to another? (Yes/No)
Y - Create and Duplicate
N - Create Only
```

3. Press "Y" for the Create and Duplicate option. The window below will appear asking you to select the Source drive to use. FastBuild will copy all data from the Source drive to the Target drive.

```
Source Disk
Channel:ID      Drive Model      Capacity (MB)
Target Disk
Channel:ID      Drive Model      Capacity (MB)
[Please Select A Source Disk]
Channel:ID      Drive Model      Capacity (MB)
1 :Master      QUANTUMCR8.4A   8063
2 :Master      QUANTUMCR8.4A   8063
[↑] Up [↓]DOWN [ESC] Exit [Enter] Select
```

4. Use the arrow keys to choose which drive contains the existing data to be copied.
5. Press [Enter] keys to selection and start duplication. The following progress screen will appear.

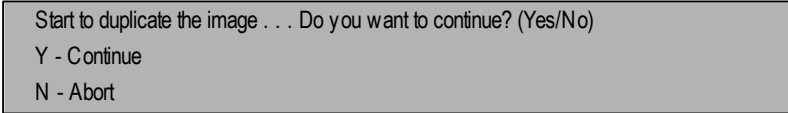

```
Start to duplicate the image . . . Do you want to continue? (Yes/No)
Y - Continue
N - Abort
```

6. Select "Y" to continue. If you choose "N" , you will be returned to step 1.
7. Once complete, the following screen will appear confirming that your Security array has been created. Press any key to reboot the system

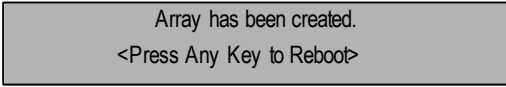

```
Array has been created.
<Press Any Key to Reboot>
```

8. Proceed to the Installing Driver chapter (see RAID Manual of the IUCD) to install the RAID driver and/or operating system.

### Using FastBuild™ Configuration Utility

The FastBuild™ Configuration Utility offers several menu choices to create and manage the drive array on the motherboard. For purposes of this manual, it is assumed you have already created an array in the previous chapter and now wish to make a change to the array or view other options.

#### Viewing BIOS Screen

When you boot your system with the RAID function and drives installed, the FastBuild BIOS will detect the drives attached and show the following screen.

```
FastTrak100 (tm)"Lite" BIOS Version 1.xx (Build xx)
(c) 1995-2001 Promise Technology, Inc. All Rights Reserved.
Scanning IDE drives . . . . .
```

If an array exists already, the BIOS will display the following screen showing the board RAID BIOS version and status of the array.

```
FastTrak100 (tm) "Lite"BIOS Version 1.xx (Build xxxx)
(c) 1995-2001 Promise Technology, Inc. All Rights Reserved.
ID   MODE SIZE           TRACK-MAPPING      STATUS
1 *  1*2 Mirror         16126M 611/128/32  Functional
Press <Ctrl-F> to enter FastBuild (tm) Utility....
```

The array status consists of three possible conditions: Functional, Critical, Offline.

Functional - The array is operational.

Critical - A mirrored array contains a drive that has failed or disconnected. The remaining drive member in the array is functional. However, the array has temporarily lost its ability to provide fault tolerance. The user should identify the failed drive through the FastBuildO Setup utility, and then replace the problem drive.

Offline - A striped array has 1 drive that has failed or been disconnected. When the array condition is "offline," the user must replace the failed drive(s), then restore data from a backup source.

### Navigating the FastBuild™ Setup Menu

When using the menus, these are some of the basic navigation tips: Arrow keys highlights through choices; [Space] bar key allows to cycle through options;

[Enter] key selects an option; [ESC] key is used to abort or exit the current menu.

### Using the Main Menu

This is the first option screen when entering the FastBuild™ Setup.

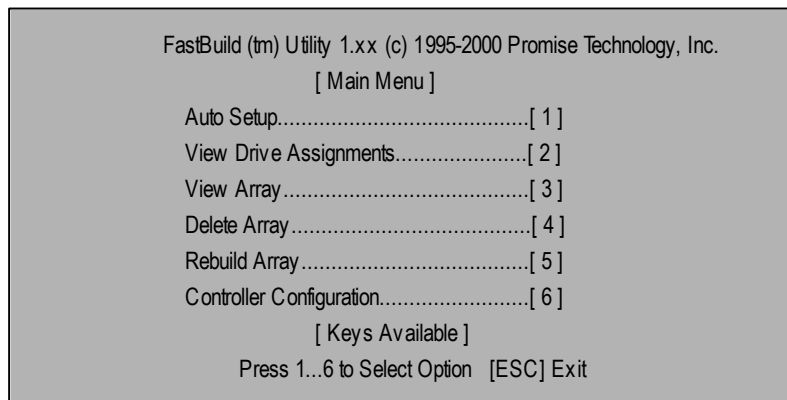

To create a new array automatically, follow the steps under "Creating Arrays Automatically" on page 80. Promise recommends this option for most users.

To view drives assigned to arrays, see "Viewing Drive Assignments" on page 82.

To delete an array (but not delete the data contained on the array), select "Deleting An Array" on page 84.

To rebuild a mirrored array, see "Rebuilding an Array" on page 86.

To view controller settings, see "Viewing Controller Configuration" on page 88.



**NOTE:** After configuring an array using FastBuild, you should FDISK and format the arrayed drive(s) if you are using new, blank drives. Depending on the type of array you are using.

### Creating Arrays Automatically

The Auto Setup <1> selection from the Main Menu can intuitively help create your disk array. It will assign all available drives appropriate for the disk array you are creating. After making all selections, use Ctrl-Y to Save selections. FastBuild will automatically build the array.

```
FastBuild (tm) Utility 1.xx (c) 1995-2000 Promise Technology, Inc.
                                [Auto Setup Options Menu]
Optimize Array for:              Performance
Typical Application usage: A/V Editing
                                [ Auto Setup Configuration ]
Mode.....Stripe
Spare Drive Count.....0
Drives used in Array.....2
Array Disk Capacity.....16126
                                [ Keys Available ]
[↑] Up [↓] Down [↵, ↵, Space] Change Option [ESC] Exit [Ctrl-Y] Save
```

### Optimize Array For

Select whether you want Performance (RAID 0), Security (RAID 1) under the "Optimize Array for" setting.

Performance (RAID 0 Striping)

Supports the maximum performance. The storage capacity equals the number of drives times the capacity of the smallest drive in the disk array.

NOTE: This motherboard permits striped arrays using 1, 2 drive attached in Auto Setup mode.

Security (RAID 1 Mirroring)

Creates a mirrored (or fault tolerant) array for data security.

NOTE: Under the Security setting, This motherboard permits two drives to be used for a single Mirrored array only.



### **Defining Typical Application Usage**

Allows the user to choose the type of PC usage that will be performed in order to optimize how This motherboard handles data blocks to enhance performance. Your choice will determine the block size used. You may choose from: A/V Editing (for audio/v ideo applications, or any similar application that requires large file transfers), Server (for numerous small file transfers), or Desktop (a combination of large and small file sizes).

### Viewing Drive Assignments

The View Drive Assignments <2> option in the Main Menu displays whether drives are assigned to a disk arrays or are unassigned.

Under the "Assignment" column, drives are labeled with their assigned disk array or shown as "Free" if unassigned. Such "Free" drives can be used for a future array. Unassigned drives are not accessible by the OS. The menu also displays the data transfer mode that relates to speed used by each drive (U5 refers to 100MB/sec transfers, U4 refers to 66MB/sec transfers, etc...)

FastBuild (tm) Utility 1.32 (c) 1996-2001 Promise Technology, Inc.				
[ View Drive Assignments ]				
Channel:ID	Drive Model	Capacity(MB)	Assignment	Mode
1 : Master	QUANTUMCR8.4A	8063	Array 1	U5
1 : Slave	QUANTUMCR8.4A	8063	Free	U5
2 : Master	QUANTUMCR8.4A	8063	Array 1	U5
[ Keys Available ]				
[↑] Up [↓] Down [ESC] Exit Mode (P=PIO, D=DMA, U=UDMA)				

### **How Orders Arrays**

During startup, the disk arrays on the motherboard are recognized in this order: 1) The array set to bootable in the FastBuild™ Setup, and 2) the Array number (i.e. Array 0, Array 1;K). This would be involved in determining which drive letters will be assigned to each disk array.

### **How Saves Array Information**

All disk array data is saved into the reserved sector on each array member. We suggests that users record their disk array information for future reference.

Another feature of the motherboard disk array system is to recognize drive members even if drives are moved between different motherboard connectors(IDE3&IDE4). Since each drive's array data identifies itself to the array, it is possible to move or swap drives without modifying the array setup. This is valuable when adding drives, or during a rebuild.

### Deleting An Array

The Delete Array <4> Menu option allows for deletion of disk array assignments. This is not the same as deleting data from the drives themselves. If you delete an array by accident (and before it has been used again), the array can normally be recovered by defining the array identically as the deleted array.



**WARNING:** Deleting an existing disk array could result in its data loss. Make sure to record all array information including the array type, the disk members, and stripe block size in case you wish to undo a deletion.

FastBuild (tm) Utility 1.32 (c) 1996-2001 Promise Technology, Inc.				
[ Delete Array Menu ]				
Array No	RAID Mode	Total Drv	Capacity(MB)	Status
Array 1	Mirror	2	8063	Functional
Array 2	Stripe	1	8063	Functional
Array 3	Stripe	1	8063	Functional
Array 4	----	----	----	----
[ Keys Available ]				
[↵] Up [⇩] Down		[ESC] Exit	[Del] Delete	

1. To delete an array, highlight the Array you wish to delete and press the [Del] key.
2. The View Array Definition menu will appear (see below) showing which drives are assigned to this array.

FastBuild (tm) Utility 1.32 (c) 1996-2001 Promise Technology, Inc.				
[ Define Array Menu ]				
Array No	RAID Mode	Total Drv	Capacity(MB)	Status
Array 1	Mirror	2	8063	Functional
Stripe Block: 64 KB				
[ Drive Assignments ]				
Channel:ID	Drive Model	Capacity (MB)	Assignment	
1 : Master	QUANTUMCR8.4A	8063	Y	
2 : Master	QUANTUMCR8.4A	8063	Y	

3. Confirm yes to the following warning message with the <Ctrl-Y> key to continue array deletion:

Are you sure you want to delete this array?  
Press Ctrl-Y to Delete, others to Abort

4. After deleting the array, you should create a new array using Auto Setup or the Define Array menu from the FastBuild Main Menu.

### Rebuilding A Mirrored Array

The Rebuild Array <5> Menu option is necessary to recover from an error in a mirrored disk array. You will receive an error message when booting your system from the BIOS.

NOTE: Drives MUST be replaced if they contain any physical errors.

Follow these steps BEFORE using the Rebuild Array menu option:

1. On bootup, the system Startup BIOS will display an error message identifying which drive has failed.
2. Press <Ctrl-F> keys to enter FastBuild Main Menu.
3. Select submenu Define Array <3>.
4. Select the failed array and identify the Channel and ID of the failed drive.
5. Power off and physically remove the failed drive.
6. Replace the drive with an identical model.
7. Reboot the system and enter the FastBuild Main Menu.
8. Select the <5> Rebuild Array option. The following screen will appear.

FastBuild (tm) Utility 1.32 (c) 1996-2001 Promise Technology, Inc.				
[ Rebuild Array Menu ]				
Array No	RAID Mode	Total Drv	Capacity (MB)	Status
Array 1	Mirror	2	16126	Critical
Array 2	Stripe	1	8063	Functional
Array 3	Stripe	1	8063	Functional
Array 4	----	----	----	-----
[ Keys Available ]				
[↑] Up [↓] Down [ESC] Exit [Enter] Select				

9. Highlight the array whose Status is "Critical".
10. Press [Enter]. The following screen will then appear (see next page).

FastBuild (tm) Utility 1.32 (c) 1996-2001 Promise Technology, Inc.  
[ Rebuild Array Menu ]  
The Previous recovery is not complete!  
<Press Any Key to Restart The Recovery>

11. Press anykey and confirm that the data will be copied on to the selected drive. All data on the replacement drive will be written over with mirrored information from the array drive. A progress bar will appear as below.

Please Wait While Duplicating The Image  
  
10% Complete

12. Once the rebuild process is complete, the user will be asked to reboot the system.

### Viewing Controller Settings

The Controller Configuration <6> menu selection allows you to enable or disable the BIOS from halting (the default) if it detects an error on boot up. You may also view the system resources (Interrupt and I/O port address) of data channels

```
FastBuild (tm) Utility 1.32 (c) 1996-2001 Promise Technology, Inc.
[ Adapter Configuration - Options ]
Halt On Error:  Enable
[ System Resources Configuration ]
Channel 1 (IDE1)  Interrupt : A I/O Port : 9800
Channel 2 (IDE2)  Interrupt : A I/O Port : A000
[ Keys Available ]
[↑, ↓ Space] Change Option [ESC] Exit
```

### Halting BIOS On Bootup Errors

The [Adapter Configuration - Options] section allows you to enable or disable The system to Halt operation at the BIOS startup screen should an error be detected. This is the only option that can be changed on this screen.

### Viewing System Resources

The [System Resources Configuration] section of this submenu displays the PCI slot interrupt and port address used by the system. The resources used are determined by the Mainboard PCI PnP BIOS for the PCI slot in which the system resides.

In the rare case that there is a resource conflict, refer to the Mainboard BIOS documentation on changes on resources allocated to the system PCI slot.



## Chapter 5 Appendix

Picture below are shown in Windows ME

### Appendix A: VIA 4 in 1 Service Pack Driver Installation

#### A. VIA 4 in 1 Service Pack Driver Utility:

Insert the driver CD-tittle that came with your motherboard into your CD-ROM driver, the driver CD-tittle will auto start and show the installation guide. If not, please double click the CD-ROM device icon in "My computer", and execute the setup.exe.



(1)

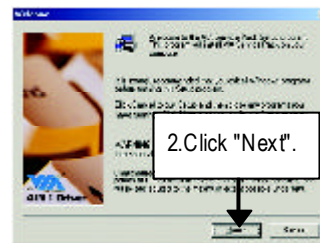

(2)



(3)



(4)



(5)



(6)



(7)



(8)

### Appendix B: AC97 Sound Chipset Driver

"AC'97 Audio Driver" under Windows ME will auto install.

### Appendix C: Creative CT5880 Chipset Driver Installation (Only for GA-7VRXP)

Insert the driver CD-title that came with your motherboard into your CD-ROM driver, the driver CD-title will auto start and show the installation guide. If not, please double click the CD-ROM device icon in "My computer", and execute the setup.exe.



(1)



(2)



(3)

**Appendix D: RealTek 8139/8100 Network Driver (Only for GA-7VRXP)**

"RealTek 8139/8100 Network Driver" under Windows ME will auto install. If you would like to install LAN driver, please refer to attached README.txt file for detail instruction. Please install the driver through CD-ROM by the path D:\Network\Rtl (This manual assumes that your CD-ROM device drive letter is D:).



(1)



(2)

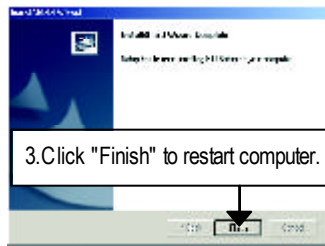

(3)

### Appendix E: Other Device Driver

#### E-1: Promise RAID Driver Information



(1)

Please refer to the detail information.



(2)

#### E-2: FastTrak Utilities Information



(3)



(4)

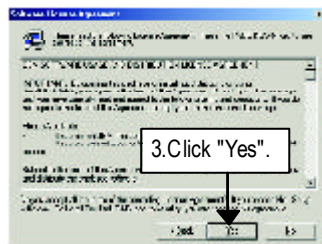

(5)



(6)



(7)

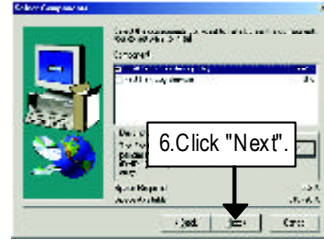

(8)



(9)



(10)



(11)



(12)

E-3: Winbond MS/SD/SCR Device Driver



(1)



(2)

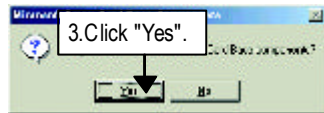

(3)

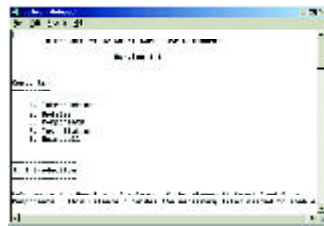

(5)

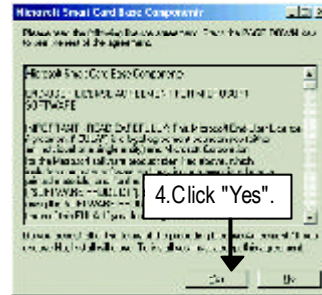

(4)



(6)

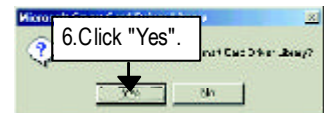

(7)

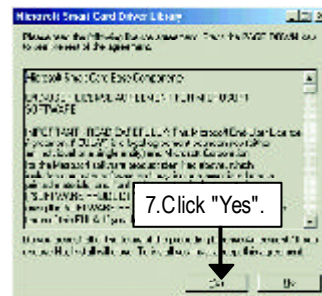

(8)



(9)

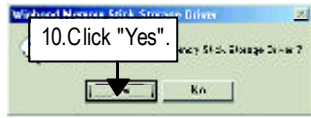

(10)

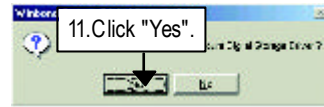

(11)

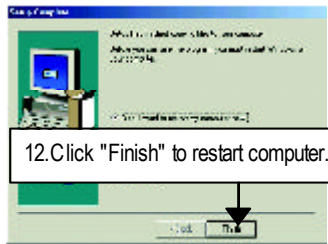

(12)

E-4: Winbond Smart Manager for Smart Card Reader



(1)



(2)



(3)



(4)



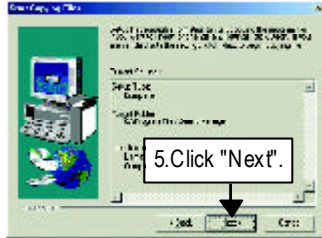

(5)

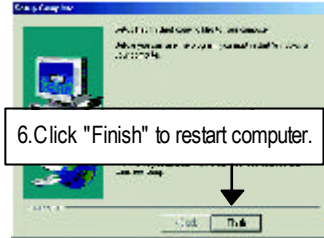

(6)

E-5:ATA133 Driver setup Information

(This manual assumes that your CD-ROM device drive letter is D:).



(1)



(2)

If you want to install ATA133 Driver, go to “Control Panel→System→Device Manager” and install driver by manually. Please refer to the following procedure:



(3)



(4)





(5)



(6)



(7)

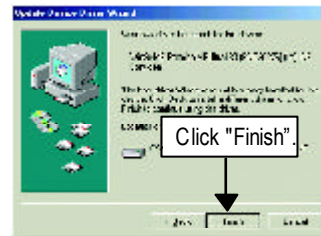

(8)



(9)

E-6:USB 2.0 Host controller



(1)



(2)

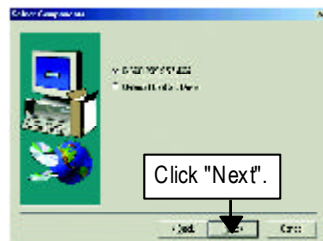

(3)

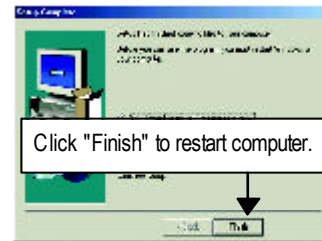

(4)

## Appendix F: Face-Wizard Utilities Installation

### What is Face-Wizard™?

Face-Wizard™ is a windows based utility with user-friendly interface that allows users to change the boot-up logo with picture from Gigabyte Logo Gallery on web site or other compatible picture you have.

### How does it work?

Face-Wizard™ allows user to select BIOS on board or file in hard drive, floppy disk , zip, MO or other storage devices and combine the compatible picture you prefer into BIOS. And not only this, Face-Wizard™ also helps user to update BIOS in windows mode.

### What's benefit for using Face-Wizard™?

It can personalize boot-up logo to show your unique style from others, and never again looking at the black and white boot up screen.



(1)



(2)



(3)

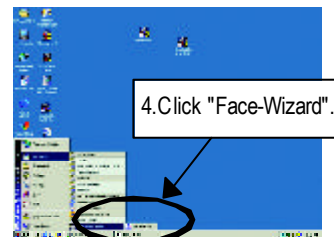

(4)

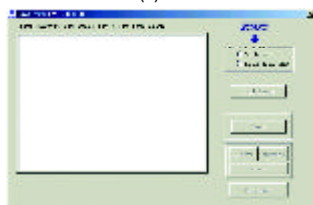

(5)

### Appendix G: EasyTuneIII Utilities Installation

Insert the driver CD-title that came with your motherboard into your CD-ROM driver, the driver CD-title will auto start and show the installation guide. If not, please double click the CD-ROM device icon in "My computer", and execute the setup.exe.

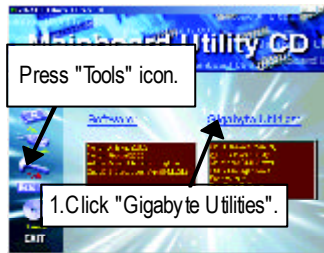

(1)



(2)



(3)

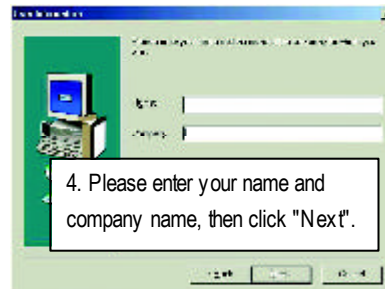

(4)



(5)

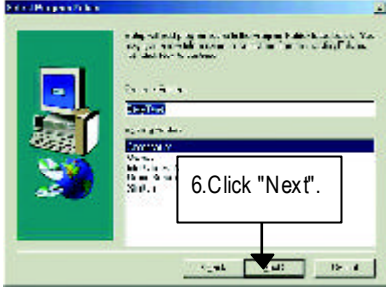

(6)

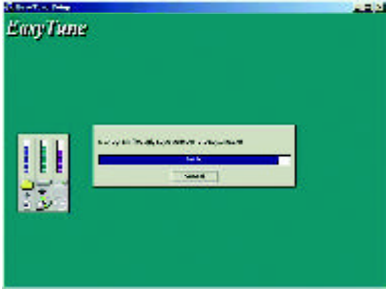

(7)



(8)

## Appendix H: BIOS Flash Procedure

BIOS update procedure:

If your OS is Win9X, we recommend that you used Gigabyte @BIOS™ Program to flash BIOS.

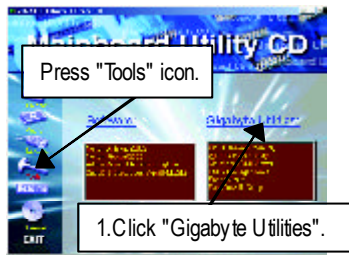

(1)



(2)



(3)

Methods and steps:

- I. Update BIOS through Internet
  - a. Click "Internet Update" icon
  - b. Click "Update New BIOS" icon
  - c. Select @BIOS™ sever ("Gigabyte @BIOS™ sever 1 in Taiwan" and "Gigabyte @BIOS™ sever 2 in Taiwan" are available for now, the others will be completed soon)
  - d. Select the exact model name on your motherboard
  - e. System will automatically download and update the BIOS.

II. Update BIOS NOT through Internet:

- a. Do not click "Internet Update" icon
- b. Click "Update New BIOS"
- c. Please select "All Files" in dialog box while opening the old file.
- d. Please search for BIOS unzip file, downloading from internet or any other methods (such as: 7VRXP.F1).
- e. Complete update process following the instruction.

III. Save BIOS

In the very beginning, there is "Save Current BIOS" icon shown in dialog box. It means to save the current BIOS version.

IV. Check out supported motherboard and Flash ROM:

In the very beginning, there is "About this program" icon shown in dialog box. It can help you check out which kind of motherboard and which brand of Flash ROM are supported.

Note:

- a. In method I, if it shows two or more motherboard's model names to be selected, please make sure your motherboard's model name again. Selecting wrong model name will cause the system unbooted.
- b. In method II, be sure that motherboard's model name in BIOS unzip file are the same as your motherboard's. Otherwise, your system won't boot.
- c. In method I, if the BIOS file you need cannot be found in @BIOS™ server, please go onto Gigabyte's web site for downloading and updating it according to method II.
- d. Please note that any interruption during updating will cause system unbooted

We use GA-7VTX motherboard and Flash841 BIOS flash utility as example.

Please flash the BIOS according to the following procedures if you are now under the DOS mode.

Flash BIOS Procedure:

STEP 1:

- (1) Please make sure you have set "Auto" for BIOS Feature Setup (BIOS Flash Protection). For more detail please refer to page 34.
- (2) Please make sure your system has installed the extraction utility such as winzip or pkunzip.  
Firstly you have to install the extraction utility such as winzip or pkunzip for unzip the files. Both of these utilities are available on many shareware download pages like <http://www.shareware.cnet.com>

STEP 2: Make a DOS boot diskette. (See example: Windows 98 O.S.)

Beware: Windows ME/2000 are not allowed to make a DOS boot diskette.

- (1) With an available floppy disk in the floppy drive. Please leave the diskette "UN-write protected" type. Double click the "My Computer" icon from Desktop, then click "3.5 diskette (A)" and right click to select "Format (M)"

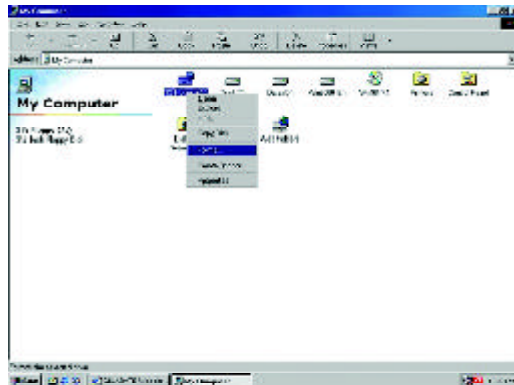



- (2) Select the "Quick (erase)" for Format Type, and pick both "Display summary when finished" and "Copy system files", after that press "Start". That will format the floppy and transfer the needed system files to it.

Beware: This procedure will erase all the prior data on that floppy, so please proceed accordingly.

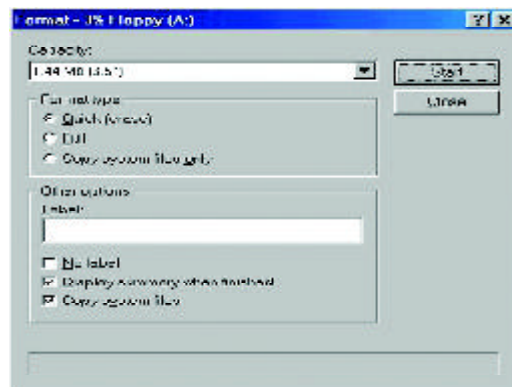

- (3) After the floppy has been formatted completely, please press "Close".

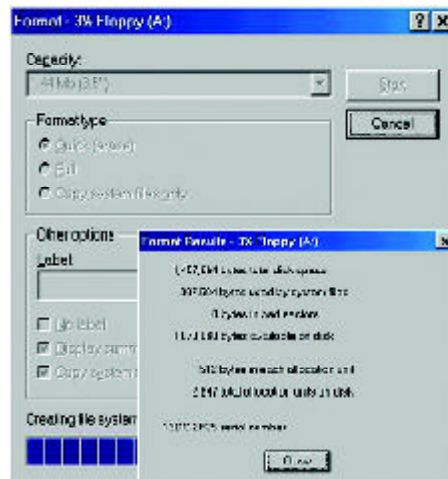

STEP 3: Download BIOS and BIOS utility program.

(1) Please go to Gigabyte website <http://www.gigabyte.com.tw/index.html>, and click "Support".



(2) From Support zone, click the "Motherboards BIOS & Drivers".

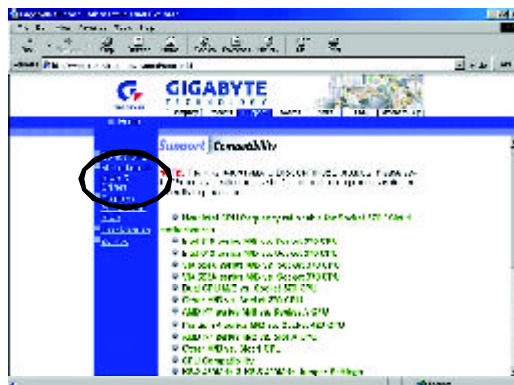

- (3) We use GA-7VTX motherboard as example. Please select GA-7VTX by Model or Chipset optional menu to obtain BIOS flash files.

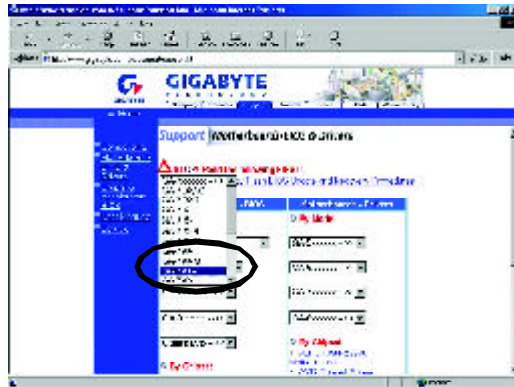

- (4) Select an appropriate BIOS version (For example: F4), and click to download the file. It will pop up a file download screen, then select the "Open this file from its current location" and press "OK".

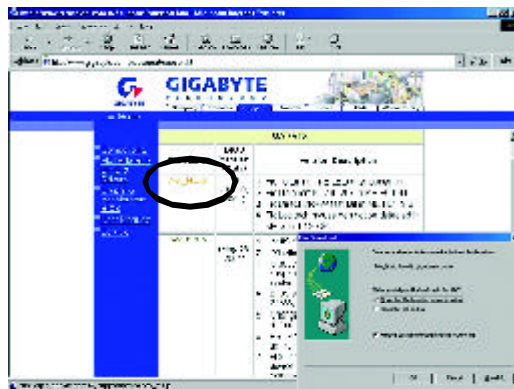

- (5) At this time the screen shows the following picture, please click "Extract" button to unzip the files.

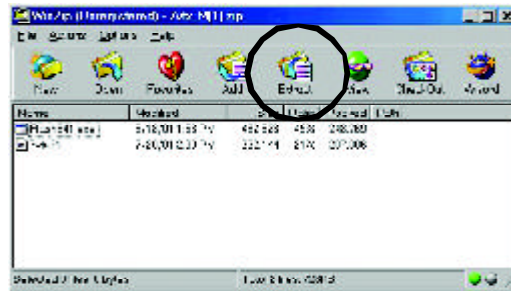

- (6) Please extract the download files into the clean bootable floppy disk A mentioned in STEP 2, and press "Extract".

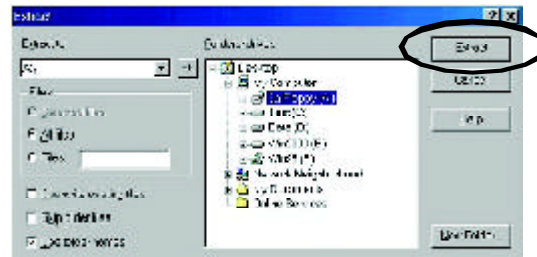

STEP 4: Make sure the system will boot from the floppy disk.

- (1) Insert the floppy disk (contains bootable program and unzip file) into the floppy drive A. Then, restart the system. The system will boot from the floppy disk. Please press <DEL> key to enter BIOS setup main menu when system is boot up.



- (2) Once you enter the BIOS setup utility, the main menu will appear on the screen. Use the arrows to highlight the item "BIOS FEATURES SETUP".

AMIBIOS SIMPLE SETUP UTILITY - VERSION 1.24b (C) 1999 American Megatrends, Inc. All Rights Reserved	
STANDARD CMOS SETUP <b>BIOS FEATURES SETUP</b> CHIPSET FEATURES SETUP POWER MANAGEMENT SETUP PNP / PCI CONFIGURATION LOAD BIOS DEFAULTS LOAD SETUP DEFAULTS	INTEGRATED PERIPHERALS HARDWARE MONITOR & MISC SETUP SUPERVISOR PASSWORD USER PASSWORD IDE HDD AUTO DETECTION SAVE & EXIT SETUP EXIT WITHOUT SAVING
ESC: Quit      ↓↓↓↓↓ : Select Item      (Shift)F2 : Change Color      F5: Old Values F6: Load BIOS Defaults      F7: Load Setup Defaults      F10: Save & Exit	
Time, Date, Hard Disk Type...	

- (3) Press "Enter" to enter "BIOS FEATURES SETUP" menu. Use the arrows to highlight the item "1st Boot Device", and then use the "Page Up" or "Page Down" keys to select "Floppy".

AMIBIOS SETUP - BIOS FEATURES SETUP	
(C) 2001 American Megatrends, Inc. All Rights Reserved	
1st Boot Device : Floppy	ESC: Quit      ↑↑↑↑ : Select Item F1 : Help      PU/PD/+/- : Modify F5 : Old Values (Shift)F2: Color F6 : Load BIOS Defaults F7 : Load Setup Defaults
2nd Boot Device : IDE-0	
3rd Boot Device : CDROM	
S.M.A.R.T. for Hard Disks : Disabled	
BootUp Num-Lock : On	
Floppy Drive Seek : Disabled	
Password Check : Setup	

- (4) Press "ESC" to go back to previous screen. Use the arrows to highlight the item "SAVE & EXIT SETUP" then press "Enter". System will ask "SAVE to CMOS and EXIT (Y/N)?" Press "Y" and "Enter" keys to confirm. Now the system will reboot automatically, the new BIOS setting will be taken effect next boot-up.

AMIBIOS SIMPLE SETUP UTILITY - VERSION 1.24b	
(C) 2001 American Megatrends, Inc. All Rights Reserved	
STANDARD CMOS SETUP	INTEGRATED PERIPHERALS
BIOS FEATURES SETUP	HARDWARE MONITOR & MISC SETUP
CHIPSET FEATURES SETUP	SUPERVISOR PASSWORD
POWER MANAGEMENT SETUP	USER PASSWORD
PNP / PCI CONF	<b>Save to CMOS and EXIT (Y/N)? Y</b>
LOAD BIOS DEFAULTS	SAVE & EXIT SETUP
LOAD SETUP DEFAULTS	EXIT WITHOUT SAVING
ESC: Quit      ↑↑↑↑↑ : Select Item      (Shift)F2 : Change Color      F5: Old Values F6: Load BIOS Defaults      F7: Load Setup Defaults      F10: Save & Exit	
Save Data to CMOS & Exit SETUP	

## STEP 5: BIOS flashing.

- (1) After the system boot from floppy disk, type "A:\> dir/w" and press "Enter" to check the entire files in floppy A. Then type the "BIOS flash utility" and "BIOS file" after A:\>. In this case you have to type "A:\> Flash841 7VTX.F4" and then press "Enter".

```
Starting Windows 98...

Microsoft(R) Windows98
  © Copyright Microsoft Corp 1981-1999

A:\> dir/w
  Volume in drive A has no label
  Volume Serial Number is 16EB-353D
  Directory of A:\
COMMAND.COM    7VTX.F4  FLASH841.EXE
               3 file(s)  838,954 bytes
               0 dir(s)   324,608 bytes free

A:\> Flash841 7VTX.F4
```

- (2) Now screen appears the following Flash Utility main menu. Press "Enter", the highlighted item will locate on the model name of the right-upper screen. Right after that, press "Enter" to start BIOS Flash Utility.

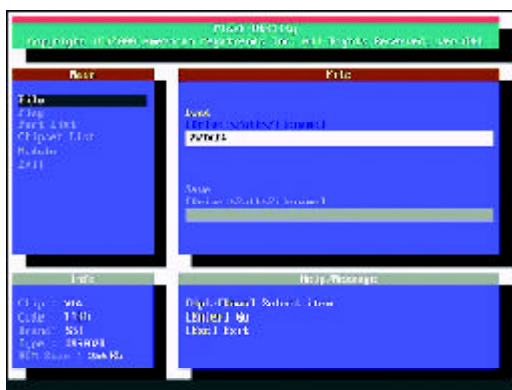

- (3) It will pop up a screen and asks "Are you sure to flash the BIOS?" Press [Enter] to continue the procedure, or press [ESC] to quit.

Beware: Please do not turn off the system while you are upgrading BIOS. It will render your BIOS corrupted and system totally inoperative.

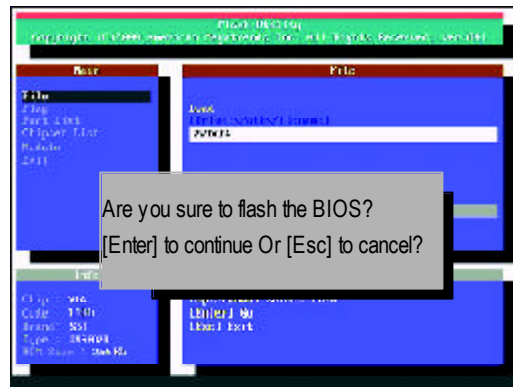

- (4) The BIOS flash completed. Please press [ESC] to exit Flash Utility.

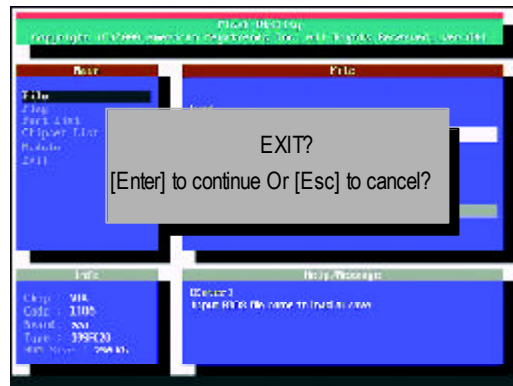



STEP 6: Load BIOS defaults.

Normally the system redetects all devices after BIOS has been upgraded. Therefore, we highly recommend reloading the BIOS defaults after BIOS has been upgraded. This important step resets everything after the flash.

- (1) Take out the floppy diskette from floppy drive, and then restart the system. The boot up screen will indicate your motherboard model and current BIOS version.



- (2) Don't forget to press <DEL> key to enter BIOS setup again when system is boot up. Use the arrows to highlight the item "LOAD SETUP DEFAULTS" then press "Enter". System will ask "Load Setup Defaults (Y/N)?" Press "Y" and "Enter" keys to confirm.

AMIBIOS SIMPLE SETUP UTILITY - VERSION 1.24b (C) 2001 American Megatrends, Inc. All Rights Reserved	
STANDARD CMOS SETUP	INTEGRATED PERIPHERALS
BIOS FEATURES SETUP	HARDWARE MONITOR & MISC SETUP
CHIPSET FEATURES SETUP	SUPERVISOR PASSWORD
POWER MANAGEMENT SETUP	USB BIOS SETUP
PNP / PCI CONFIGURATION	Load Setup Defaults? (Y/N)?N
LOAD BIOS DEFAULTS	SAVE & EXIT SETUP
LOAD SETUP DEFAULTS	EXIT WITHOUT SAVING
ESC: Quit    ↑ ↓ ← → : Select Item    (Shift)F2 : Change Color    F5: Old Values F6: Load BIOS Defaults    F7: Load Setup Defaults    F10: Save & Exit	
Load Setup Defaults	

- (3) Use the arrows to highlight the item "SAVE & EXIT SETUP" and press "Enter". System will ask "SAVE to CMOS and EXIT (Y/N)?" Press "Y" and "Enter" keys to confirm. Now the system will reboot automatically, the new BIOS setting will be taken effect next boot-up.

AMIBIOS SIMPLE SETUP UTILITY - VERSION 1.24b	
(C) 2001 American Megatrends, Inc. All Rights Reserved	
STANDARD CMOS SETUP	INTEGRATED PERIPHERALS
BIOS FEATURES SETUP	HARDWARE MONITOR & MISC SETUP
CHIPSET FEATURES SETUP	SUPERVISOR PASSWORD
POWER MANAGEMENT SETUP	USER PASSWORD
PNP / PCI CONF	SAVE to CMOS and EXIT (Y/N)? Y
LOAD BIOS DEFAULTS	SAVE & EXIT SETUP
LOAD SETUP DEFAULTS	EXIT WITHOUT SAVING
ESC: Quit    ↑ ↓ ← → : Select Item    (Shift)F2 : Change Color    F5: Old Values	
F6: Load BIOS Defaults    F7: Load Setup Defaults    F10: Save & Exit	
Save Data to CMOS & Exit SETUP	

- (4) Congratulate you have accomplished the BIOS flash procedure.

**Appendix I: Acronyms**

Acronyms	Meaning
ACPI	Advanced Configuration and Power Interface
APM	Advanced Power Management
AGP	Accelerated Graphics Port
AMR	Audio Modem Riser
ACR	Advanced Communications Riser
BIOS	Basic Input / Output System
CPU	Central Processing Unit
CMOS	Complementary Metal Oxide Semiconductor
CRIMM	Continuity RIMM
CNR	Communication and Networking Riser
DMA	Direct Memory Access
DMI	Desktop Management Interface
DIMM	Dual Inline Memory Module
DRM	Dual Retention Mechanism
DRAM	Dynamic Random Access Memory
DDR	Double Data Rate
ECP	Extended Capabilities Port
ESCD	Extended System Configuration Data
ECC	Error Checking and Correcting
EMC	Electromagnetic Compatibility
EPP	Enhanced Parallel Port
ESD	Electrostatic Discharge
FDD	Floppy Disk Device
FSB	Front Side Bus
HDD	Hard Disk Device
IDE	Integrated Dual Channel Enhanced
IRQ	Interrupt Request
I/O	Input / Output
IOAPIC	Input Output Advanced Programmable Input Controller
ISA	Industry Standard Architecture
LAN	Local Area Network

to be continued.....

---

GA-7VRX/GA-7VRXP Motherboard

---

Acronyms	Meaning
LBA	Logical Block Addressing
LED	Light Emitting Diode
MHz	Megahertz
MIDI	Musical Instrument Digital Interface
MTH	Memory Translator Hub
MPT	Memory Protocol Translator
NIC	Network Interface Card
OS	Operating System
OEM	Original Equipment Manufacturer
PAC	PCI A.G.P. Controller
POST	Power-On Self Test
PCI	Peripheral Component Interconnect
RIMM	Rambus in-line Memory Module
SCI	Special Circumstance Instructions
SECC	Single Edge Contact Cartridge
SRAM	Static Random Access Memory
SMP	Symmetric Multi-Processing
SMI	System Management Interrupt
USB	Universal Serial Bus
VID	Voltage ID

---

**Technical Support/RMA Sheet**

Customer/Country :	Company :	Phone No.:
Contact Person:	E-mail Add. :	

Model name/Lot Number:	PCB revision:
BIOS version:	O.S./A.S.:

Hardware Configuration	Mfs.	Model name	Size:	Driver/Utility:
CPU				
Memory				
Brand				
Video Card				
Audio Card				
HDD				
CD-ROM / DVD-ROM				
Modem				
Network				
AMR / CNR				
Keyboard				
Mouse				
Power supply				
Other Device				

Problem Description:

---



---