

FCC Compliance Statement:

<p style="text-align: center;">DECLARATION OF CONFORMITY <small>Per FCC Part 2 Section 2.107(a)</small></p> <p style="text-align: center;">FCC</p> <p>Responsible Party Name: G.B.T. INC. Address: 18305 Valley Blvd., Suite#A LA Puente, CA 91744 Phone/Fax No: (818) 854-9338 / (818) 854-9339</p> <p>hereby declares that the product Product Name: Mother Board Model Number: GA-7ZX-41</p> <p>Conforms to the following specifications: FCC Part 15, Subpart B, Section 15.107(a) and Section 15.109(a), Class B Digital Device</p> <p>Supplementary Information: This device complies with part 15 of the FCC Rules. Operation is subject to the following two conditions: (1) This device may not cause harmful interference and (2) this device must accept any interference received, including that may cause undesired operation.</p> <p>Representative Person's Name: <u>ERIC LU</u> Signature: <u>Eric Lu</u> Date: <u>Mar. 20, 2001</u></p>
--

This equipment has been tested and found to comply with limits for a Class B digital device, pursuant to Part 15 of the FCC rules. These limits are designed to provide reasonable protection against harmful interference in residential installations. This equipment generates, uses, and can radiate radio frequency energy, and if not installed and used in accordance with the instructions, may cause harmful interference to radio communications. However, there is no guarantee that interference will not occur in a particular installation. If this equipment does cause interference to radio or television equipment reception, which can be

determined by turning the equipment off and on, the user is encouraged to try to correct the interference by one or more of the following measures:

- Reorient or relocate the receiving antenna
- Move the equipment away from the receiver
- Plug the equipment into an outlet on a circuit different from that to which the receiver is connected
- Consult the dealer or an experienced radio/television technician for additional suggestions

You are cautioned that any change or modifications to the equipment not expressly approve by the party responsible for compliance could void Your authority to operate such equipment.

This device complies with Part 15 of the FCC Rules. Operation is subjected to the following two conditions 1) this device may not cause harmful interference and 2) this device must accept any interference received, including interference that may cause undesired operation.

Declaration of Conformity

We, Manufacturer/Importer
(full address)

G.B.T. Technology Trading GmbH
Ausschlagler Weg 41, 1F, 20537 Hamburg, Germany

declare that the product
(description of the apparatus, system, installation to which it refers)

Mother Board
GA-7ZX-H

is in conformity with
(reference to the specification under which conformity is declared)
in accordance with 89/336 EEC-EMC Directive

- | | | | |
|---|--|--|--|
| <input type="checkbox"/> EN 55011 | Limits and methods of measurement of radio disturbance characteristics of industrial, scientific and medical (ISM) high frequency equipment | <input type="checkbox"/> EN 61000-3-2*
<input checked="" type="checkbox"/> EN60555-2 | Disturbances in supply systems caused by household appliances and similar electrical equipment "Harmonics" |
| <input type="checkbox"/> EN55013 | Limits and methods of measurement of radio disturbance characteristics of broadcast receivers and associated equipment | <input type="checkbox"/> EN61000-3-3*
<input checked="" type="checkbox"/> EN60555-3 | Disturbances in supply systems caused by household appliances and similar electrical equipment "Voltage fluctuations" |
| <input type="checkbox"/> EN 55014 | Limits and methods of measurement of radio disturbance characteristics of household electrical appliances, portable tools and similar electrical apparatus | <input checked="" type="checkbox"/> EN 50081-1
<input checked="" type="checkbox"/> EN 50082-1 | Generic emission standard Part 1: Residual, commercial and light industry
Generic immunity standard Part 1: Residual, commercial and light industry |
| <input type="checkbox"/> EN 55015 | Limits and methods of measurement of radio disturbance characteristics of fluorescent lamps and luminaries | <input type="checkbox"/> EN 55081-2 | Generic emission standard Part 2: Industrial environment |
| <input type="checkbox"/> EN 55020 | Immunity from radio interference of broadcast receivers and associated equipment | <input type="checkbox"/> EN 55082-2 | Generic immunity standard Part 2: Industrial environment |
| <input checked="" type="checkbox"/> EN 55022 | Limits and methods of measurement of radio disturbance characteristics of information technology equipment | <input type="checkbox"/> ENV 55104 | Immunity requirements for household appliances tools and similar apparatus |
| <input type="checkbox"/> DIN VDE 0855
<input type="checkbox"/> part 10
<input type="checkbox"/> part 12 | Cabled distribution systems; Equipment for receiving and/or distribution from sound and television signals | <input type="checkbox"/> EN 50091- 2 | EMC requirements for uninterruptible power systems (UPS) |
| <input checked="" type="checkbox"/> CE marking | |  | (EC conformity marking) |

The manufacturer also declares the conformity of above mentioned product with the actual required safety standards in accordance with LVD 73/23 EEC

- | | | | |
|-----------------------------------|---|-------------------------------------|---|
| <input type="checkbox"/> EN 60065 | Safety requirements for mains operated electronic and related apparatus for household and similar general use | <input type="checkbox"/> EN 60950 | Safety for information technology equipment including electrical business equipment |
| <input type="checkbox"/> EN 60335 | Safety of household and similar electrical appliances | <input type="checkbox"/> EN 50091-1 | General and Safety requirements for uninterruptible power systems (UPS) |

Manufacturer/Importer

(Stamp)

Date : Mar. 20, 2001

Signature : Rex Lin
Name : Rex Lin

7ZX-H
AMD Athlon™/Duron™ Socket A Processor
Motherboard

USER'S MANUAL

AMD Athlon™/Duron™ Socket A Processor Motherboard
REV. 5.1 First Edition
R-51-01-010419

How This Manual Is Organized

This manual is divided into the following sections:

1) Revision History	Manual revision information
2) Item Checklist	Product item list
3) Features	Product information & specification
4) Hardware Setup	Instructions on setting up the motherboard
5) Performance & Block Diagram	Product performance & block diagram
6) Suspend to RAM & Dual BIOS	Instructions STR installation & Dual BIOS
7) @BIOS™ & EasyTuneIII™	@BIOS™ & EasyTuneIII™ introduction
8) BIOS Setup	Instructions on setting up the BIOS software
9) Appendix	General reference

Table Of Content

Revision History	P.1
Item Checklist	P.2
Summary of Features	P.3
7ZX-H Motherboard Layout	P.5
Page Index for CPU Speed Setup / Connectors / Panel and Jumper Definition	P.6
Performance List	P.22
Block Diagram	P.23
Suspend to RAM Installation	P.24
Dual BIOS Introduction (Optional)	P.30
@BIOS™ Introduction	P.37
EasyTuneIII™ Introduction	P.38
Memory Installation	P.40
Page Index for BIOS Setup	P.41
Appendix	P.72

Revision History

Revision	Revision Note	Date
5.1	Initial release of the 7ZX-H motherboard user's manual.	Apr. 2001

The author assumes no responsibility for any errors or omissions that may appear in this document nor does the author make a commitment to update the information contained herein. Third-party brands and names are the property of their respective owners.

Apr. 19, 2001 Taipei, Taiwan, R.O.C

Item Checklist

- The 7ZX-H motherboard
- Cable for IDE / floppy device
- CD (TUCD) for motherboard driver & utility
- 7ZX-H user's manual

Summary Of Features

Form Factor	<ul style="list-style-type: none"> • 30.5 cm x 22.8 cm ATX size form factor, 4 layers PCB.
CPU	<ul style="list-style-type: none"> • AMD Athlon™/Duron™ (K7) Socket A Processor • 256K/64K L2 cache on die • Supports 600MHz ~ 1GHz and faster • Support 100/133MHz FSB
Chipset	Apollo KT133A, consisting of: <ul style="list-style-type: none"> • VT8363A Memory/AGP/PCI Controller (PAC) • VT82C686B PCI Super-I/O Integrated Peripheral Controller (PSIPC)
Clock Generator	<ul style="list-style-type: none"> • ICW W230H • ICW W230H 100/102/104/106/108/110/112/133 MHz system bus speeds
Memory	<ul style="list-style-type: none"> • 3 168-pin DIMM sockets • Supports PC-100 / PC-133 SDRAM and VCM SDRAM • Supports up to 1.5GB DRAM • Supports only 3.3V SDRAM DIMM
I/O Control	<ul style="list-style-type: none"> • VT82C686B
Slots	<ul style="list-style-type: none"> • 1 AGP slot supports 4X mode & AGP 2.0 compliant • 5 PCI slots supports 33MHz & PCI 2.2 compliant • 1 AMR (Audio Modem Riser) slot • 1 ISA slot (Optional)
On-Board IDE	<ul style="list-style-type: none"> • Supports PIO mode 3, 4, UDMA 33/ATA 66/ATA 100& ATAPI CD-ROM • 2 IDE bus master (UDMA 33 / ATA 66 / ATA 100) IDE ports for up to 4 ATAPI devices
On-Board Peripherals	<ul style="list-style-type: none"> • 1 floppy port supports 2 FDD with 360K, 720K, 1.2M, 1.44M and 2.88M bytes • 1 parallel ports supports Normal/EPP/ECP mode • 2 serial ports (COM A & COM B) • 4 USB ports • 1 IrDA connector for IR
Hardware Monitor	<ul style="list-style-type: none"> • CPU/System fan revolution detect • CPU/System temperature detect • System voltage detect • CPU overheat shutdown detect

To be continued...

Summary of Features

PS/2 Connector	<ul style="list-style-type: none">• PS/2[®] Keyboard interface and PS/2[®] Mouse interface
On-Board Sound	<ul style="list-style-type: none">• AC'97 CODEC• Line In/Line Out/Mic In/AUX In/CD In/TEL/Game Port
BIOS	<ul style="list-style-type: none">• Licensed AMI BIOS, 2M bit flash ROM• Support Dual BIOS (Optional)
Additional Features	<ul style="list-style-type: none">• Support Wake-On-LAN (WOL)• Support Internal / External Modem Ring On• Support USB KB/MS Wake up from S3-S5• Includes 3 fan power connectors• Poly fuse for keyboard over-current protection• Support STR (Suspend-To-RAM) function• Support @BIOS[™] and EasyTuneIII[™]

7ZX-H Motherboard Layout

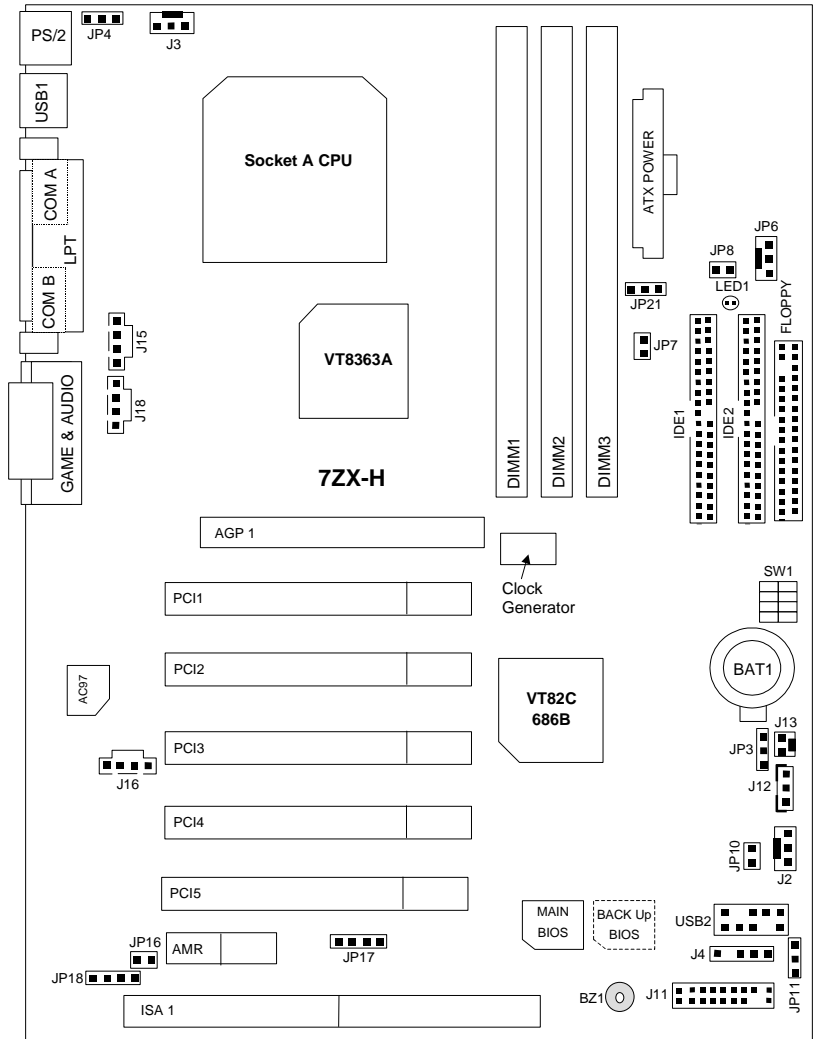

 Page Index for CPU Speed Setup/Connectors/Panel and Jumper Definition	Page
CPU Speed Setup	P.7
Connectors	P.8
Game & Audio Port	P.8
COM A / COM B / LPT Port	P.8
USB 1 Connector	P.9
USB 2 Connector	P.9
PS/2 Keyboard & PS/2 Mouse Connector	P.10
J3 (CPU Fan)	P.10
JP6 (Power Fan)	P.11
J2 (System Fan)	P.11
ATX Power	P.12
Floppy Port	P.12
IDE 1(Primary) / IDE 2(Secondary) Port	P.13
J16 (TEL)	P.13
J15 (AUX_IN)	P.14
J18 (CD Audio Line In)	P.14
J13 (Ring Power On)	P.15
J12 (Wake On LAN)	P.15
JP8 / LED1 (STR LED Connector & DIMM LED)	P.16
J4 (IR)	P.16
Panel and Jumper Definition	P.17
J11 (2x11 Pins Jumper)	P.17
JP16/JP17/JP18 (AMR Select)[Optional]	P.18
JP4 (Rear USB Device Wake Up Selection)	P.18
JP7 (STR Function Enable)	P.19
JP11 (Front USB Device Wake Up Selection)	P.19
JP10 (BIOS Write Protection)[Optional]	P.20
JP3 (Clear CMOS Function)[Optional]	P.20
BAT1 (Battery)	P.21

CPU Speed Setup

The system bus speed is selectable at 100-133MHz. The user can select the system bus speed by DIP switch **SW1** & **JP21**.

Set System Bus Speed

SW1: O: ON / X: OFF

FSB	1	2	3	4
95	O	O	X	X
★100	O	X	X	X
102	O	O	O	X
104	X	X	X	O
106	O	X	X	O
108	O	O	X	O
110	O	X	O	O
112	O	O	O	O
133	O	X	O	X

JP21: CPU Clock Frequency (Optional)

Pin No.	Definition
1-2 close	133MHz
2-3 close	100MHz (Default)

⚠ AMD CPU Heat Sink Installation:

Beware: Please check that the heat sink is in good contact with the CPU before you turn on your system.

The poor contact will cause over heat, and might cause damage to your processor.

Connectors

Game & Audio Port

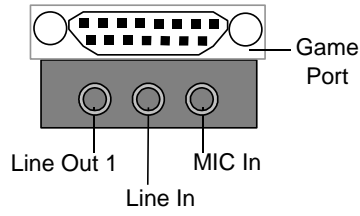
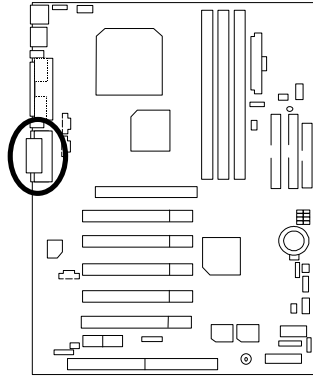

COM A / COM B / LPT Port

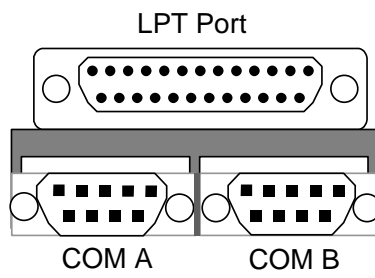
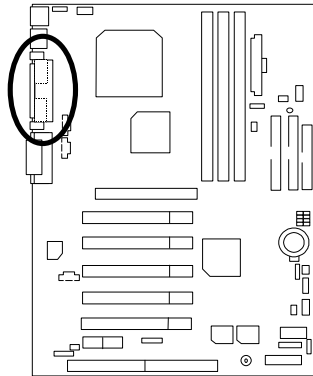

USB 1 Connector

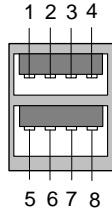
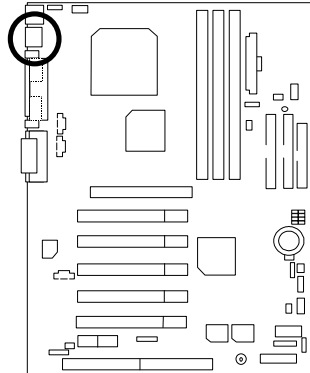

Pin No.	Definition
1	USB V0
2	USB D0-
3	USB D0+
4	GND
5	USB V1
6	USB D1-
7	USB D1+
8	GND

USB 2 Connector

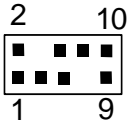
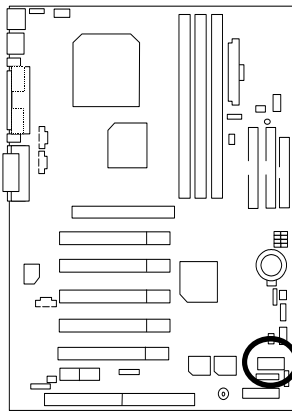

Pin No.	Definition
1	+5V
2	GND
3	USB D2-
4	NC
5	USB D2+
6	USB D3+
7	NC
8	USB D3-
9	GND
10	+5V

PS/2 Keyboard & PS/2 Mouse Connector

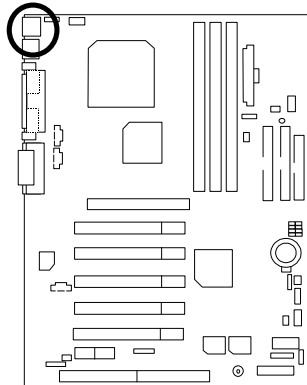

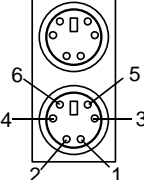
PS/2 Mouse

 PS/2 Keyboard

PS/2 Mouse/Keyboard	
Pin No.	Definition
1	Data
2	NC
3	GND
4	VCC(+5V)
5	Clock
6	NC

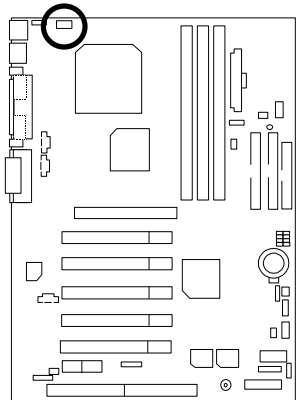
J3: CPU Fan



Pin No.	Definition
1	Control
2	+12V
3	SENSE

JP6: Power Fan

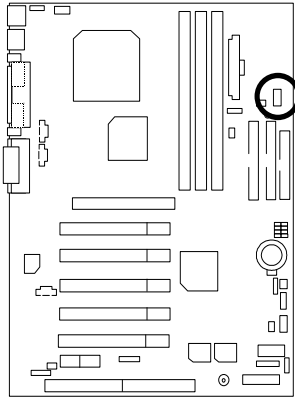

Pin No.	Definition
1	Control
2	+12V
3	NC

J2: Sysem Fan

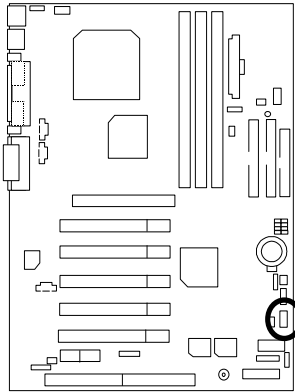

Pin No.	Definition
1	Control
2	+12V
3	SENSE

ATX Power

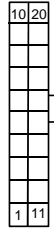
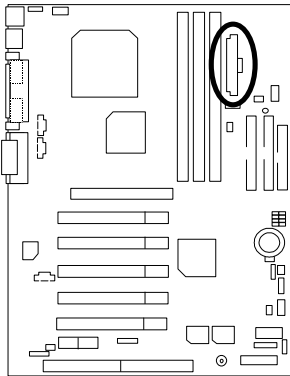

Pin No.	Definition
3,5,7,13, 15-17	GND
1,2,11	3.3V
4,6,19,20	VCC
10	+12V
12	-12V
18	-5V
8	Power Good
9	5V SB (stand by+5V)
14	PS-ON (Soft On/Off)

Floppy Port

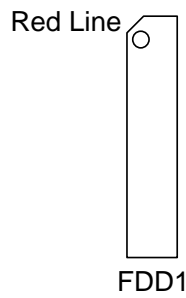
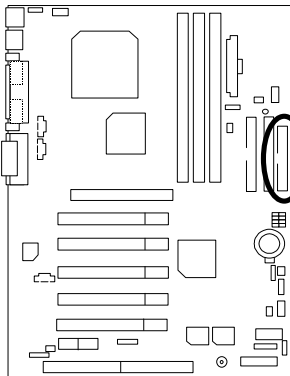

IDE1 (Primary), IDE2 (Secondary) Port

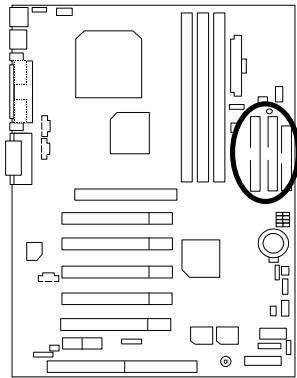

Red Line

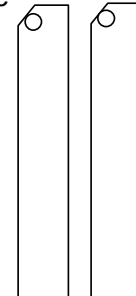

IDE 1 IDE 2

J16 TEL: The connector is for Modem with internal voice connector

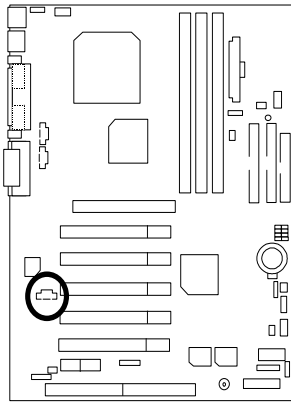

Pin No.	Definition
1	Signal-In
2	GND
3	GND
4	Signal-Out

J15: AUX_IN

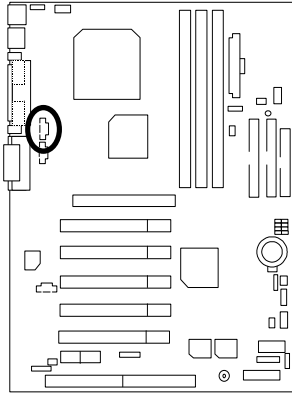

Pin No.	Definition
1	AUX-L
2	GND
3	GND
4	AUX-R

J18: CD Audio Line In

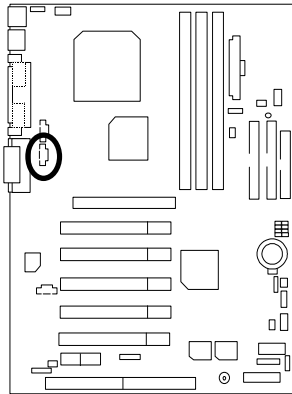

Pin No.	Definition
1	CD-L
2	GND
3	GND
4	CD-R

J13: Ring Power On (Internal Modem Card Wake Up)

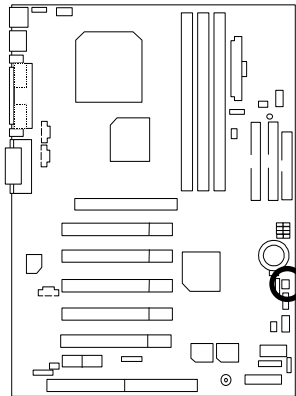

Pin No.	Definition
1	Signal
2	GND

J12: Wake On LAN

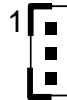
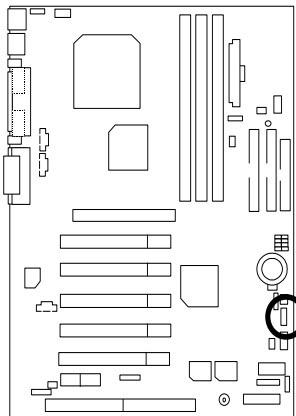

Pin No.	Definition
1	+5V SB
2	GND
3	Signal

JP8 / LED1: STR LED Connector & DIMM LED

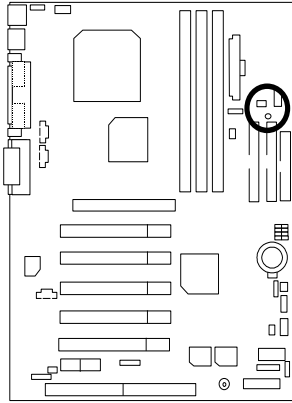

STR LED Connector External.

1 +  DIMM LED

J4: IR

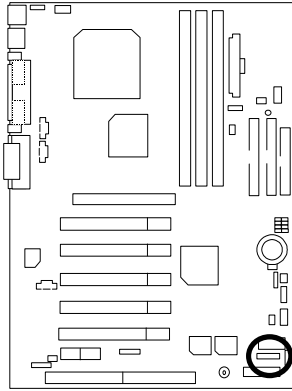
1 

Pin No.	Definition
1	VCC (+5V)
2	NC
3	IR Data Input
4	GND
5	IR Data Output

Panel And Jumper Definition

J11: 2x11 Pins Jumper

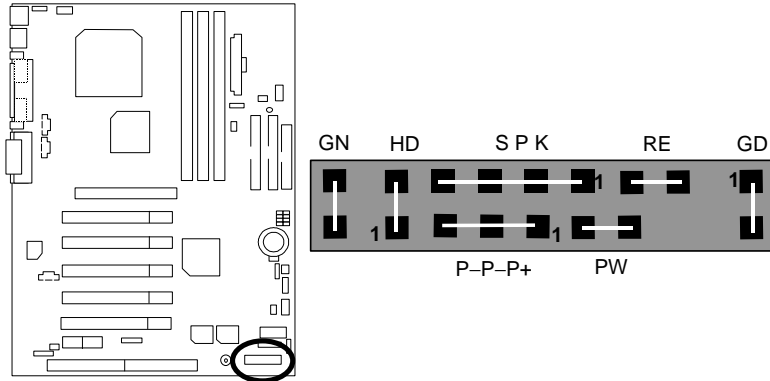

GN (Green Switch)	Open: Normal Operation Close: Entering Green Mode
GD (Green LED)	Pin 1: LED anode(+) Pin 2: LED cathode(-)
HD (IDE Hard Disk Active LED)	Pin 1: LED anode(+) Pin 2: LED cathode(-)
SPK (Speaker Connector)	Pin 1: VCC(+) Pin 2- Pin 3: NC Pin 4: Data(-)
RE (Reset Switch)	Open: Normal Operation Close: Reset Hardware System
P+P-P-(Power LED)	Pin 1: LED anode(+) Pin 2: LED cathode(-) Pin 3: LED cathode(-)
PW (Soft Power Connector)	Open: Normal Operation Close: Power On/Off

**JP16 /JP17/JP18: AMR (Primary or Secondary) Select (Optional)
(AMR→ Audio Modem Riser)**

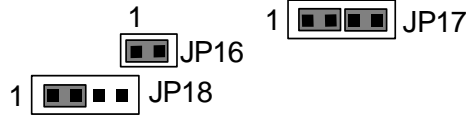
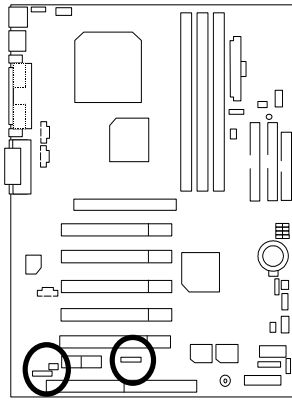

	JP16	JP17	JP18
Onboard AC97	ON	1-2	1-2
AMR (Primary)	OFF	3-4	3-4
Onboard AC97+MR (Secondary) (Default)	ON	1-2 3-4	1-2

JP4: Rear USB Device Wake up Selection (USB Connector → USB1)

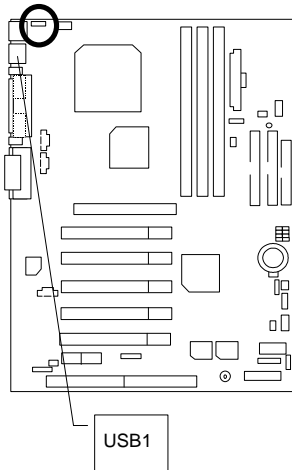

Pin No.	Definition
1-2 Close	Normal (Default)
2-3 Close	USB Device Wake up

(If you want to use "USB Dev Wakeup From S3-S5" function, you have to set the BIOS setting "USB Dev Wakeup From S3-S5" enabled, and the jumper "JP4" enabled).
 *(Power on the computer and as soon as memory counting starts, press . You will enter BIOS Setup. Select the item "POWER MANAGEMENT SETUP", then select "USB Dev Wakeup From S3-S5: Enabled". Remember to save the setting by pressing "ESC" and choose the "SAVE & EXIT SETUP" option.)

JP7: STR Function Enable

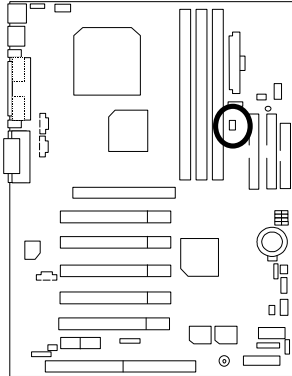

Pin No.	Definition
Open	Normal (Default)
Close	STR Enabled

JP11: Front USB Device Wake up Selection (USB Port → USB2)

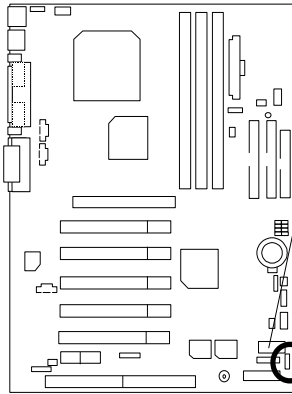

USB2



Pin No.	Definition
1-2 close	Normal (Default)
2-3 close	Enabled Front USB Device Wake up

(If you want to use "USB Dev Wakeup From S3-S5" function, you have to set the BIOS setting "USB Dev Wakeup From S3-S5" enabled, and the jumper "JP11" enabled).
 *(Power on the computer and as soon as memory counting starts, press . You will enter BIOS Setup. Select the item "POWER MANAGEMENT SETUP", then select "USB Dev Wakeup From S3-S5: Enabled". Remember to save the setting by pressing "ESC" and choose the "SAVE & EXIT SETUP" option.)

JP10: BIOS Write Protection (Optional)

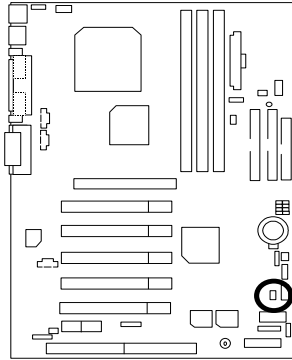

Pin No.	Definition
ON	Write Protect Enable
OFF	Write Protect Disable (Default)

⚠ Please Set Jumper JP10 to "OFF" to enabled BIOS Write Function when you update new BIOS or new device

JP3: Clear CMOS Function (Optional)

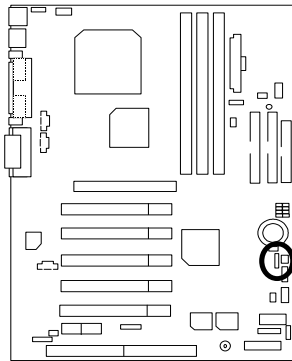

Pin No.	Definition
1-2 close	Normal (Default)
2-3 close	Clear CMOS

BAT1: Battery

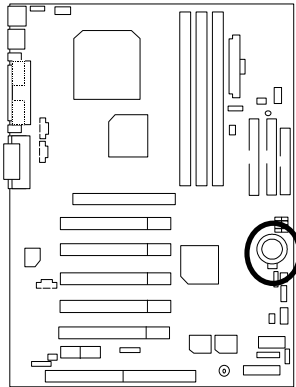

CAUTION

- ⚠ Danger of explosion if battery is incorrectly replaced.
- ⚠ Replace only with the same or equivalent type recommended by the manufacturer.
- ⚠ Dispose of used batteries according to the manufacturer's instructions.

Performance List

The following performance data list is the testing results of some popular benchmark testing programs.

These data are just referred by users, and there is no responsibility for different testing data values gotten by users. (The different Hardware & Software configuration will result in different benchmark testing results.)

- CPU AMD Althon™ 1200MHz, AMD Duron™ 900MHz
- DRAM (128x1) MB SDRAM (Winbond W986408CH-75)
- CACHE SIZE 384 KB included in Althon™
192 KB included in Duron™
- DISPLAY GA-GF2000
- STORAGE Onboard IDE (Quantum AS30000AT 30GB)
- O.S. Windows 2000 + SP1 + DirectX8
- DRIVER Display Driver at 1024 x 768 x 64k colors 75Hz.
TUCD ver.1.7

Processor	AMD Althon™ 1200MHz (100x12)	AMD Duron™ 900MHz (100x9)
Winbench99		
Business Disk Winmark 99	7500	7700
Hi-End Disk Winmark 99	15400	15200
Business Graphics Winmark 99	525	370
Hi-End Graphics Winmark 99	1170	881
Winstone 2001		
Business Winstone 2001	42.3	31.7
Content Creative Winstone 2001	43.7	35.2

●*: If you wish to maximize the performance of your system, please refer to the detail on P.50

Block Diagram

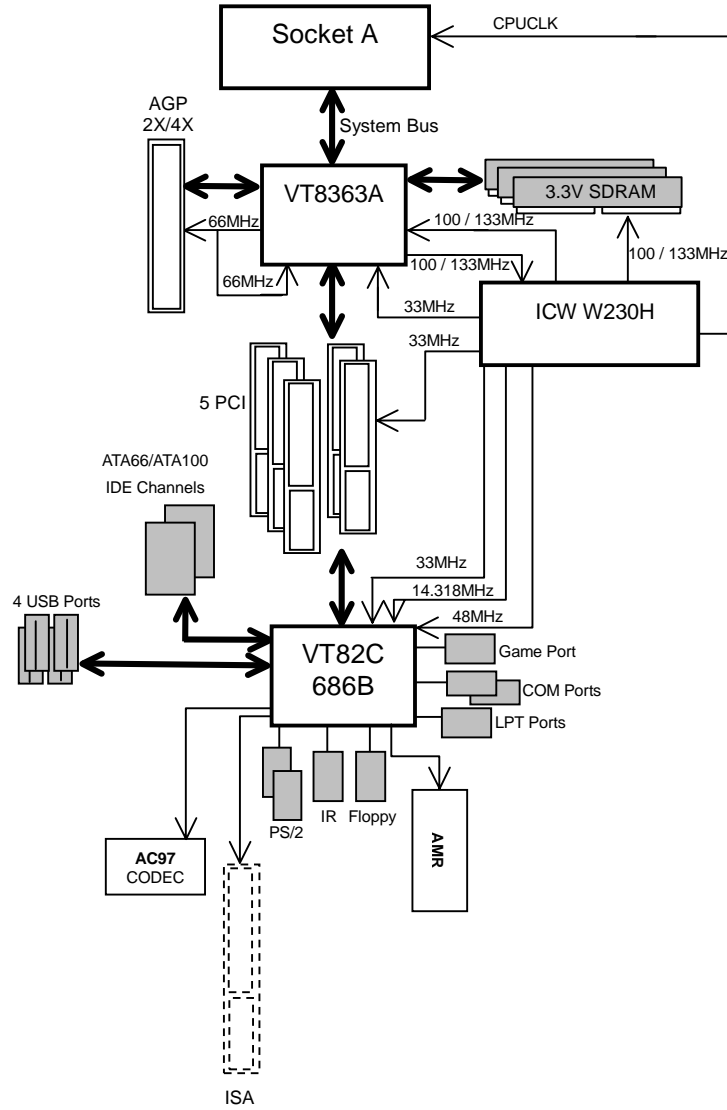

Suspend To RAM Installation

A.1 Introduce STR function:

Suspend-to-RAM (STR) is a Windows 98 ACPI sleep mode function. When recovering from STR (S3) sleep mode, the system is able, in just a few seconds, to retrieve the last "state" of the system before it went to sleep and recover to that state. The "state" is stored in memory (RAM) before the system goes to sleep. During STR sleep mode, your system uses only enough energy to maintain critical information and system functions, primarily the system state and the ability to recognize various "wake up" triggers or signals, respectively.

A.2 STR function Installation

Please use the following steps to complete the STR function installation.

Step-By-Step Setup

Step 1:

To utilize the STR function, the system must be in Windows 98 ACPI mode.

Putting Windows 98 into ACPI mode is fairly easy.

Setup with Windows 98 CD:

- A. Insert the Windows 98 CD into your CD-ROM drive, select Start, and then Run.
- B. Type (without quotes) "**D:\setup**" in the window provided. Hit the enter key or click OK.
- C. After setup completes, remove the CD, and reboot your system
(This manual assumes that your CD-ROM device drive letter is D:).

Step 2:

(If you want to use STR Function, please set jumper JP7 Closed.)

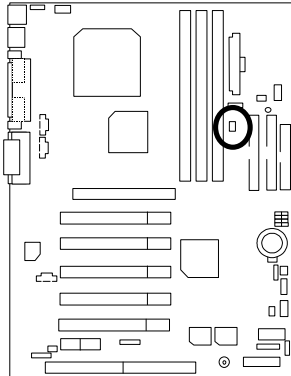

Pin No.	Definition
Open	Normal (Default)
Close	STR Enabled

Step 3:

Power on the computer and as soon as memory counting starts, press . You will enter BIOS Setup. Select the item **"POWER MANAGEMENT SETUP"**, then select **"ACPI Sleep Type : S3 / STR"**. Remember to save the settings by pressing "ESC" and choose the **"SAVE & EXIT SETUP"** option.

Congratulation! You have completed the installation and now can use the STR function.

A.3 How to put your system into STR mode?

There are two ways to accomplish this:

1. Choose the "Stand by" item in the "Shut Down Windows" area.
 - A. Press the "Start" button and then select "Shut Down"



- B. Choose the "Stand by" item and press "OK"

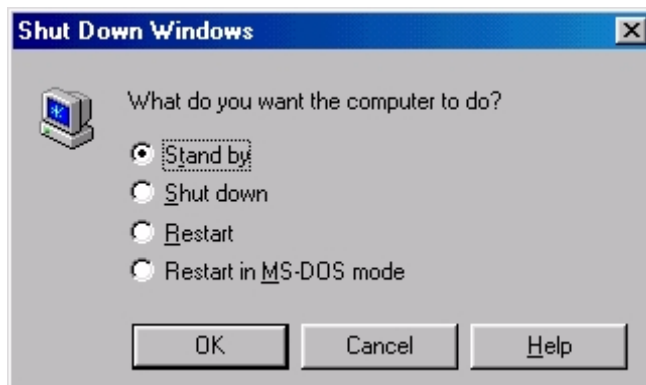

2. Define the system "power on" button to initiate STR sleep mode:

A. Double click "My Computer" and then "Control Panel"



B. Double click the " Power Management" item.

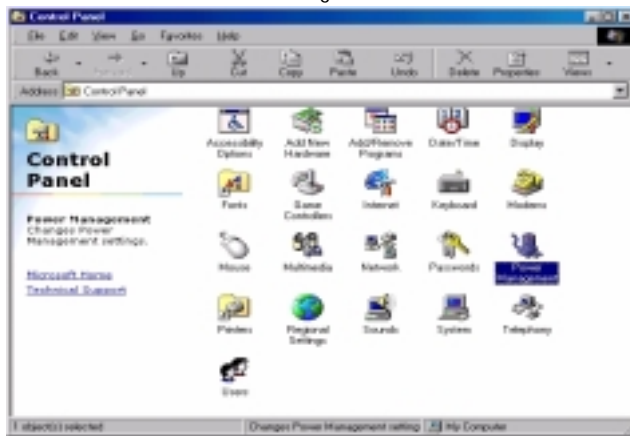

C. Select the "Advanced" tab and "Standby" mode in Power Buttons.

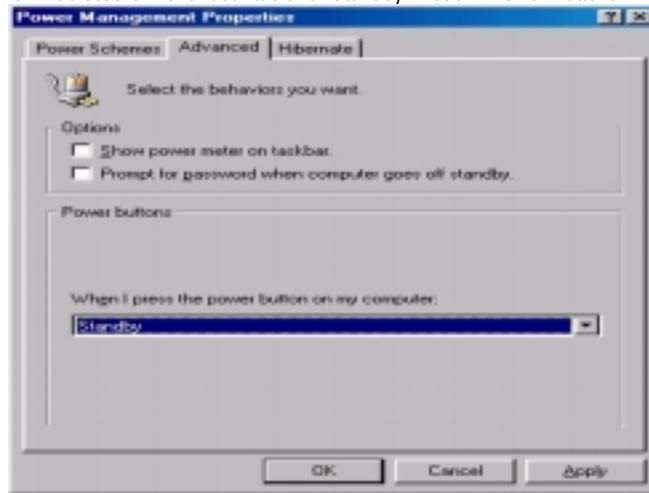

D. Restart your computer to complete setup.

Now when you want to enter STR sleep mode, just momentarily press the "Power on" button.

A.4 How to recover from the STR sleep mode?

There are five ways to "wake up" the system:

1. Press the "Power On" button.
2. Use the "Resume by Alarm" function.
3. Use the "Modem Ring On" function.
4. Use the "Wake On LAN" function.
5. Use the "USB Device Wake Up" function.

A.5 Notices:

1. In order for STR to function properly, several hardware and software requirements must be satisfied:
 - A. Your ATX power supply must comply with the ATX 2.01 specification (provide more than 720 mA 5V Stand-By current).
 - B. Your SDRAM must be PC-100/PC-133 compliant.
2. Jumper JP8 is provided to connect to the STR LED in your system chassis. [Your chassis may not provide this feature.] The STR LED will be illuminated when your system is in STR sleep mode.

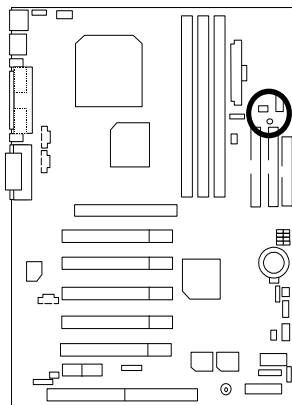

STR LED Connector External.



Dual BIOS Introduction (Optional)

A. What is Dual BIOS Technology?

Dual BIOS means that there are two system BIOS (ROM) on the motherboard, one is the Main BIOS and the other is Backup BIOS. Under the normal circumstances, the system works on the Main BIOS. If the Main BIOS is corrupted or damaged, the Backup BIOS can take over while the system is powered on. This means that your PC will still be able to run stably as if nothing has happened in your BIOS.

B. How to use Dual BIOS?

a. Boot Screen

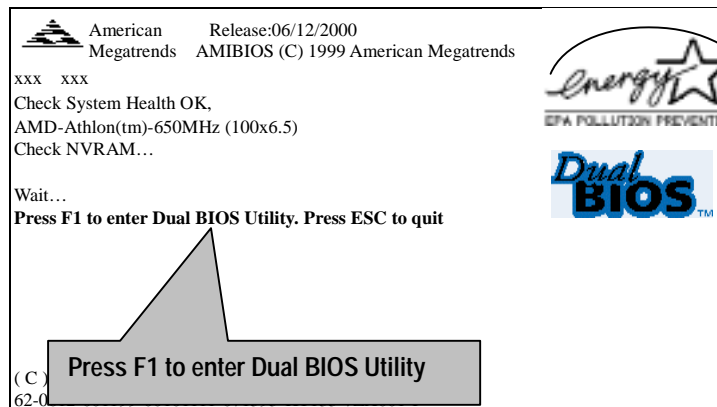

b. AMI Dual BIOS Flash ROM Programming Utility

AMI Dual BIOS Flash ROM Programming Utility	
Boot From.....	Main BIOS
Main ROM Type.....	SST 39SF020
Backup ROM Type.....	SST 39SF020
Wide Range Protection	Disable
Boot From	Main BIOS
Auto Recovery	Enable
Halt On Error	Disable
Copy Main ROM Data to Backup	
Load Default Settings	
Save Settings to CMOS	
PgDn/PgUp:Modify ↑↓:Move ESC:Reset F10:Power Off	

c. Dual BIOS Item explanation:

BIOS will auto detect:

Boot From : Main BIOS

Main ROM Type : SST 39SF020

Backup ROM Type : SST 39SF020

Wide Range Protection: Disable(Default), Enable

Status 1:

If any failure (ex. Update ESCD failure, checksum error or reset...) occurs in the Main BIOS , just before the Operating System is loaded and after the power is on, and that the Wide Range Protection is set to "Enable", the PC will boot from Backup BIOS automatically.

Status 2:

If the ROM BIOS on peripherals cards(ex. SCSI Cards, LAN Cards,..) emits signals to request restart of the system after the user make any alteration on it, the boot up BIOS will not be changed to the Backup BIOS.

Boot From : Main BIOS (Default), Backup BIOS

Status 1:

The user can set to boot from main BIOS or Backup BIOS.

Auto Recovery : Enable(Default), Disable

When one of the Main BIOS or Backup BIOS occurs checksum failure, the working BIOS will automatically recover the BIOS of checksum failure.

(In the Power Management Setup of the BIOS Setting, if ACPI Suspend Type is set to Suspend to RAM, the Auto Recovery will be set to Enable automatically.)

(If you want to enter the BIOS setting, please press "Del" key when the boot screen appears.)

Halt On Error : Disable(Default), Enable

If the BIOS occurs a checksum error or the Main BIOS occurs a WIDE RANGE PROTECTION error and Halt On BIOS Defects set to Enable, the PC will show messages on the boot screen, and the system will pause and wait for the user's instruction.

If Auto Recovery: **Disable**, it will show *<or the other key to continue.>*

If Auto Recovery: **Enable**, it will show *<or the other key to Auto Recover.>*

Copy Main ROM Data to Backup

Backup message:

Are you sure to copy BIOS?

[Enter] to continue or [Esc] to abort ...

The means that the Main BIOS works normally and could automatically recover the Backup BIOS. Or the means that the Backup BIOS works normally and could automatically recover the Main BIOS.

(This auto recovery utility is set by system automatically and can't be changed by user.)



DualBIOS™ Technology FAQ

GIGABYTE Technology is pleased to introduce DualBIOS technology, a hot spare for your system BIOS. This newness "Value-added" feature, in a long series of innovations from GIGABYTE, is available on GA-7ZX-H motherboard. Future GIGABYTE motherboards will also incorporate this innovation.

What's DualBIOS™?

On GIGABYTE motherboards with DualBIOS there are physically two BIOS chips. For simplicity we'll call one your "Main BIOS" and the other we'll call your "Backup" BIOS (your "hot spare"). If your Main BIOS fails, the Backup BIOS almost automatically takes over on your next system boot. Almost automatically and with virtually zero down time! Whether the problem is a failure in flashing your BIOS or a virus or a catastrophic failure of the Main BIOS chip, the result is the same - the Backup BIOS backs you up, almost automatically.

I. Q: What is DualBIOS™ technology?

Answer:

DualBIOS technology is a patented technology from Giga-Byte Technology. The concept of this technology is based on the redundancy and fault tolerance theory. DualBIOS™ technology simply means there are two system BIOSes (ROM) integrated onto the motherboard. One is a main BIOS, and the other is a backup BIOS. The mainboard will operate normally with the main BIOS, however, if the main BIOS is corrupt or damaged for various reasons, the backup BIOS will be automatically used when the system powered-On. Your PC will operate as before the main BIOS was damaged, and is completely transparent to the user.

II. Q: Why does anyone need a motherboard with DualBIOS™ technology?

Answer:

In today's systems there are more and more BIOS failures. The most common reasons are virus attacks, BIOS upgrade failures, and/or deterioration of the BIOS (ROM) chip itself.

1. New computer viruses are being found that attack and destroy the system BIOS. They may corrupt your BIOS code, causing your PC to be unstable or even not boot normally.
2. BIOS data will be corrupted if a power loss/surge occurs, or if a user resets the system, or if the power button is pressed during the process of performing a system BIOS upgrade.
3. If a user mistakenly updates their mainboard with the incorrect BIOS file, then the system may not be able to boot correctly. This may cause the PC system hang in operation or during boot.
4. A flash ROM's life cycle is limited according to electronic characteristics. The modern PC utilizes the Plug and Play BIOS, and is updated regularly. If a user changes peripherals often, there is a slight chance of damage to the flash ROM.

With Giga-Byte Technology's patented DualBIOS™ technology you can reduce the possibility of hangs during system boot up, and/or loss BIOS data due to above reasons. This new technology will eliminate valuable system down time and costly repair bills cause by BIOS failures.

III. Q: How does DualBIOS™ technology work?

Answer:

1. DualBIOS™ technology provides a wide range of protection during the boot up procedure. It protects your BIOS during system POST, ESCD update, and even all the way to PNP detection/assignment.
2. DualBIOS™ provides automatic recovery for the BIOS. When the first BIOS used during boot up does not complete or if a BIOS checksum error occurs, boot-up is still possible. In the DualBIOS™ utility, the "Auto Recovery" option will guarantee that if either the main BIOS or backup BIOS is corrupted, the DualBIOS™ technology will use the good BIOS and correct the wrong BIOS automatically.
3. DualBIOS™ provides manual recovery for the BIOS. DualBIOS™ technology contains a built-in flash utility, which can flash your system BIOS from backup to main and/or visa versa. There is no need for an OS-dependent flash utility program.
4. DualBIOS™ contains a one-way flash utility. The built-in one-way flash utility will ensure that the corrupt BIOS is not mistaken as the good BIOS during recovery and that the correct BIOS (main vs. backup) will be flashed. This will prevent the good BIOS from being flashed.

IV. Q: Who Needs DualBIOS™ technology?

Answer:

1. Every user should have DualBIOS™ technology due to the advancement of computer viruses.
Everyday, there are new BIOS-type viruses discovered that will destroy your system BIOS. Most commercial products on the market do not have solutions to guard against this type of virus intrusion. The DualBIOS™ technology will provide a state-of-the-art solution to protect your PC:
Case I.) Vicious computer viruses may wipe out your entire system BIOS. With a conventional single system BIOS PC, the PC will not be functional until it is sent for repairs.
Case II.) If the "Auto Recovery" option is enable in the DualBIOS™ utility, and if a virus corrupts your system BIOS, the backup BIOS will automatically reboot the system and correct the main BIOS.
Case III.) A user may override booting from the main system BIOS. The DualBIOS™ utility may be entered to manually change the boot sequence to boot from the backup BIOS.

2. During or after a BIOS upgrade, if DualBIOS™ detects that the main BIOS is corrupt, the backup BIOS will take over the boot-up process automatically. Moreover, it will verify the main and backup BIOS checksums when booting-up. DualBIOS™ technology examines the checksum of the main and backup BIOS while the system is powered on to guarantee your BIOS operates properly.
3. Power Users will have the advantage of having two BIOS versions on their mainboard. The benefit is being able to select either version BIOS to suit the performance system needs.
4. Flexibility for high-end desktop PCs and workstation/servers. In the DualBIOS™ utility, the option can be set, "Halt On When BIOS Defects," to be able to halt your system with a warning message that the main BIOS has been corrupted. Most workstation/servers require constant operation to guarantee services have not been interrupted. In this situation, the "Halt On When BIOS Defects" message may be disable to avoid system pauses during normal booting. Another advantage you gain from Giga-Byte's DualBIOS™ technology is the ability to upgrade from dual 2 Mbit BIOS to dual 4 Mbit BIOS in the future if extra BIOS storage is need.

@BIOS™ Introduction

Gigabyte announces @BIOS™ Windows BIOS live update utility



Have you ever updated BIOS by yourself? Or like many other people, you just know what BIOS is, but always hesitate to update it? Because you think updating newest BIOS is unnecessary and actually you don't know how to update it.

Maybe not like others, you are very experienced in BIOS updating and spend quite a lot of time to do it. But of course you don't like to do it too much. First, download different BIOS from website and then switch the operating system to DOS mode. Secondly, use different flash utility to update BIOS. The above process is not a interesting job. Besides, always be carefully to store the BIOS source code correctly in your disks as if you update the wrong BIOS, it will be a nightmare.

Certainly, you wonder why motherboard vendors could not just do something right to save your time and effort and save you from the lousy BIOS updating work? Here it comes! Now Gigabyte announces @BIOS™--the first Windows BIOS live update utility. This is a smart BIOS update software. It could help you to download the BIOS from internet and update it. Not like the other BIOS update software, it's a Windows utility. With the help of "@BIOS™", BIOS updating is no more than a click.

Besides, no matter which mainboard you are using, if it's a Gigabyte's product*, @BIOS™ help you to maintain the BIOS. This utility could detect your correct mainboard model and help you to choose the BIOS accordingly. It then downloads the BIOS from the nearest Gigabyte ftp site automatically. There are several different choices: you could use "Internet Update" to download and update your BIOS directly. Or you may want to keep a backup for your current BIOS, just choose "Save Current BIOS" to save it first. You make a wise choice to use Gigabyte, and @BIOS™ update your BIOS smartly. You are now worry free from updating wrong BIOS, and capable to maintain and manage your BIOS easily. Again, Gigabyte's innovative product erects a milestone in mainboard industries.

For such a wonderful software, how much it costs? Impossible! It's free! Now, if you buy a Gigabyte's motherboard, you could find this amazing software in the attached driver CD. But please remember, connected to internet at first, then you could have a internet BIOS update from your Gigabyte @BIOS™.

EasyTuneIII™ Introduction

Gigabyte announces EasyTuneIII™ Windows overdrive utility



“Overdrive” might be one of the most common issues in computer field. But have many users ever tried it? The answer is probably “no”. Because “overdrive” is thought to be very difficult and includes a lot of technical know-how, sometimes “overdrive” is even considered as special skills found only in some enthusiasts.

But as to the experts in “overdrive”, what’s the truth? They may spend quite a lot of time and money to study, try and use many different hardware and software tools to do “overdrive”. And even with these technologies, they still learn that it’s quite a risk because the safety and stability of an “overdrive” system is unknown.

Now everything is different because of a Windows overdrive utility EasyTuneIII™--announced by Gigabyte. This utility has totally changed the gaming rule of “overdrive”. This is the first overdrive utility suitable for both normal and power users. Users can choose either “Easy Mode” or “Advanced Mode” to run “overdrive” at their convenience. For users who choose “Easy Mode”, they just need to click “Auto Optimize” to have auto and immediate CPU overclocking. This software will then overdrive CPU speed automatically with the result being shown in the control panel. If someone prefers to “overdrive” by oneself, there is also another choice. Click “Advanced Mode” to enjoy “sport drive” class overclocking. In “Advanced Mode”, one can change the system bus speed in small increments to get ultimate system performance. And no matter which mainboard is used, if it’s a Gigabyte’s product*, EasyTuneIII™ helps to perform the best of system.

Besides, different from other traditional over-clocking methods, EasyTuneIII™ doesn’t require users to change neither BIOS nor hardware switch/ jumper setting; on the other hand, they can do “overdrive” at only one click. Therefore, this is a safer way for “overdrive” as nothing is changed on software or hardware. If user runs EasyTuneIII™ over system’s limitation, the biggest lost is only to restart the computer again and the side effect is then well controlled. Moreover, if one well-performed system speed been tested in EasyTuneIII™, user can “Save” this bus speed and “Load” it in next time. Obviously, Gigabyte EasyTuneIII™ has already turned the “overdrive” technology toward to a newer generation.

This wonderful software is now free bundled in Gigabyte motherboard attached driver CD. Users may make a test drive of "EasyTuneIII™" to find out more amazing features by themselves.

For further technical information, please link to: <http://www.gigabyte.com.tw>

※ Note: For the latest version of EasyTuneIII™, please visit our website.

Memory Installation

The motherboard has 3 dual inline memory module (DIMM) sockets. The BIOS will automatically detects memory type and size. To install the memory module, just push it vertically into the DIMM Slot .The DIMM module can only fit in one direction due to the two notch. Memory size can vary between sockets.

Install memory in any combination table:

DIMM	168-pin SDRAM DIMM Modules	
DIMM 1	Supports 16 / 32 / 64 / 128 / 256 / 512 MB	X 1 pcs
DIMM 2	Supports 16 / 32 / 64 / 128 / 256 / 512 MB	X 1 pcs
DIMM 3	Supports 16 / 32 / 64 / 128 / 256 / 512 MB	X 1 pcs

★Total System Memory (Max 1.5GB)

 Page Index for BIOS Setup	Page
The Main Menu	P.43
Standard CMOS Setup	P.45
BIOS Features Setup	P.48
Chipset Features Setup	P.50
Power Management Setup	P.54
PNP/ PCI Configuration	P.57
Load BIOS Defaults	P.60
Load Setup Defaults	P.61
Integrated Peripherals	P.62
Hardware Monitor & MISC Setup	P.66
Supervisor Password / User Password	P.68
IDE HDD Auto Detection	P.69
Save & Exit Setup	P.70
Exit Without Saving	P.71

BIOS Setup

BIOS Setup is an overview of the BIOS Setup Program. The program that allows users to modify the basic system configuration. This type of information is stored in battery-backed CMOS RAM so that it retains the Setup information when the power is turned off.

ENTERING SETUP

Power ON the computer and press immediately will allow you to enter Setup. If the message disappears before you respond and you still wish to enter Setup, restart the system to try again by turning it OFF then ON or pressing the "RESET" bottom on the system case. You may also restart by simultaneously press <Ctrl> – <Alt>– keys.

CONTROL KEYS

<↑>	Move to previous item
<↓>	Move to next item
<←>	Move to the item in the left hand
<→>	Move to the item in the right hand
<Esc>	Main Menu - Quit and not save changes into CMOS Status Page Setup Menu and Option Page Setup Menu - Exit current page and return to Main Menu
<+/PgUp>	Increase the numeric value or make changes
<-/PgDn>	Decrease the numeric value or make changes
<F1>	General help, only for Status Page Setup Menu and Option Page Setup Menu
<F2>	Reserved
<F3>	Reserved
<F4>	Reserved
<F5>	Restore the previous CMOS value from CMOS, only for Option Page Setup Menu
<F6>	Load the default CMOS value from BIOS default table, only for Option Page Setup Menu
<F7>	Load the Setup Defaults
<F8>	Reserved
<F9>	Reserved
<F10>	Save all the CMOS changes, only for Main Menu

GETTING HELP

Main Menu

The on-line description of the highlighted setup function is displayed at the bottom of the screen.

Status Page Setup Menu / Option Page Setup Menu

Press F1 to pop up a small help window that describes the appropriate keys to use and the possible selections for the highlighted item. To exit the Help Window press <Esc>.

The Main Menu

Once you enter AMI BIOS CMOS Setup Utility, the Main Menu (Figure 1) will appear on the screen. The Main Menu allows you to select from nine setup functions and two exit choices. Use arrow keys to select among the items and press <Enter> to accept or enter the sub-menu.

AMIBIOS SIMPLE SETUP UTILITY-VERSION 1.24b (C) 1999 American Megatrends, Inc. All Rights Reserved	
STANDARD CMOS SETUP	INTEGRATED PERIPHERALS
BIOS FEATURES SETUP	HARDWARE MONITOR & MISC SETUP
CHIPSET FEATURES SETUP	SUPERVISOR PASSWORD
POWER MANAGEMENT SETUP	USER PASSWORD
PNP/PCI CONFIGURATION	IDE HDD AUTO DETECTION
LOAD BIOS DEFAULTS	SAVE & EXIT SETUP
LOAD SETUP DEFAULTS	EXIT WITHOUT SAVING
ESC : Quit ↑↓←→ : Select Item (Shift) F2 : Change Color F5 : Old Values F6 : Load BIOS Defaults F7 : Load Setup Defaults F10 : Save & Exit	
Time, Date, Hard Disk Type, ...	

Figure 1: Main Menu

- **Standard CMOS Setup**
This setup page includes all the items in standard compatible BIOS.
- **BIOS Features Setup**
This setup page includes all the items of AMI special enhanced features.

- **Chipset Features Setup**

This setup page includes all the items of chipset special features.
- **Power Management Setup**

This setup page includes all the items of Green function features.
- **PNP/PCI Configurations**

This setup page includes all the configurations of PCI & PnP ISA resources.
- **Load BIOS Defaults**

Bios Defaults indicates the value of the system parameter which the system would be in the safe configuration.
- **Load Setup Defaults**

Setup Defaults indicates the value of the system parameter which the system would be in the most appropriate configuration.
- **Integrated Peripherals**

This setup page includes all onboard peripherals.
- **Hardware Monitor & MISC Setup**

This setup page is auto detect fan and temperature status.
- **Supervisor password**

Change, set, or disable password. It allows you to limit access to the system and Setup, or just to Setup.
- **User password**

Change, set, or disable password. It allows you to limit access to the system.
- **IDE HDD auto detection**

Automatically configure hard disk parameters.
- **Save & Exit Setup**

Save CMOS value settings to CMOS and exit setup.
- **Exit Without Saving**

Abandon all CMOS value changes and exit setup.

Standard CMOS Setup

The items in Standard CMOS Features Menu (Figure 2) are divided into 9 categories. Each category includes no, one or more than one setup items. Use the arrows to highlight the item and then use the <PgUp> or <PgDn> keys to select the value you want in each item.

AMIBIOS SETUP – STANDARD CMOS SETUP (C) 1999 American Megatrends, Inc. All Rights Reserved																																									
Date (mm/dd/yyyy) : Fri Mar 9, 2001 Time (hh/mm/ss) : 10:36:24																																									
<table border="1"> <thead> <tr> <th>TYPE</th> <th>SIZE</th> <th>CYLS</th> <th>HEAD</th> <th>PRECOMP</th> <th>LANDZ</th> <th>SECTOR</th> <th>MODE</th> </tr> </thead> <tbody> <tr> <td>Pri Master</td> <td>: Auto</td> <td></td> <td></td> <td></td> <td></td> <td></td> <td></td> </tr> <tr> <td>Pri Slave</td> <td>: Auto</td> <td></td> <td></td> <td></td> <td></td> <td></td> <td></td> </tr> <tr> <td>Sec Master</td> <td>: Auto</td> <td></td> <td></td> <td></td> <td></td> <td></td> <td></td> </tr> <tr> <td>Sec Slave</td> <td>: Auto</td> <td></td> <td></td> <td></td> <td></td> <td></td> <td></td> </tr> </tbody> </table>		TYPE	SIZE	CYLS	HEAD	PRECOMP	LANDZ	SECTOR	MODE	Pri Master	: Auto							Pri Slave	: Auto							Sec Master	: Auto							Sec Slave	: Auto						
TYPE	SIZE	CYLS	HEAD	PRECOMP	LANDZ	SECTOR	MODE																																		
Pri Master	: Auto																																								
Pri Slave	: Auto																																								
Sec Master	: Auto																																								
Sec Slave	: Auto																																								
Floppy Drive A: 1.44 MB 3 ½	Base Memory : 640 Kb																																								
Floppy Drive B: Not Installed	Other Memory: 384 Kb																																								
Boot Sector Virus Protection : Disabled	Extended Memory: 127Mb																																								
	Total Memory: 128Mb																																								
Month: Jan – Dec	ESC : Exit																																								
Day: 01 – 31	↑↓ : Select Item																																								
Year: 1990– 2099	PU/PD/+/- : Modify																																								
	(Shift)F2 : Color																																								

Figure 2: Standard CMOS Setup

- **Date**

The date format is <Week> <Month> <Day>, <Year>.

Week	The week, from Sun to Sat, determined by the BIOS and is display-only
Month	The month, Jan. Through Dec.
Day	The day, from 1 to 31 (or the maximum allowed in the month)
Year	The year, from 1990 through 2099

- **Time**

The times format in <hour> <minute> <second>. The time is calculated base on the 24-hour military-time clock. For example, 1 p.m. is 13:00:00.

- **Primary Master, Slave / Secondary Master, Slave**

The category identifies the types of hard disk from drive C to F that has been installed in the computer. There are two types: auto type, and user definable type. User type is user-definable; Auto type which will automatically detect HDD type.

Note that the specifications of your drive must match with the drive table. The hard disk will not work properly if you enter improper information for this category.

If you select User Type, related information will be asked to enter to the following items. Enter the information directly from the keyboard and press <Enter>. Such information should be provided in the documentation form your hard disk vendor or the system manufacturer.

CYLS.	Number of cylinders
HEADS	number of heads
PRECOMP	write precomp
LANDZONE	Landing zone
SECTORS	number of sectors

If a hard disk has not been installed select NONE and press <Enter>.

- **Floppy Drive A / Drive B**

The category identifies the types of floppy disk drive A or drive B that has been installed in the computer.

None	No floppy drive installed
360K, 5.25 in.	5.25 inch PC-type standard drive; 360K byte capacity.
1.2M, 5.25 in.	5.25 inch AT-type high-density drive; 1.2M byte capacity (3.5 inch when 3 Mode is Enable).
720K, 3.5 in.	3.5 inch double-sided drive; 720K byte capacity
1.44M, 3.5 in.	3.5 inch double-sided drive; 1.44M byte capacity.
2.88M, 3.5 in.	3.5 inch double-sided drive; 2.88M byte capacity.

- **Boot Sector Virus Protection**

If it is set to enable, the category will flash on the screen when there is any attempt to write to the boot sector or partition table of the hard disk drive. The system will halt and the following error message will appear in the mean time. You can run anti-virus program to locate the problem.

Enabled	Activate automatically when the system boots up causing a warning message to appear when anything attempts to access the boot sector or hard disk partition table
Disabled	No warning message to appear when anything attempts to access the boot sector or hard disk partition table. (Default Value)

- **Memory**

The category is display-only which is determined by POST (Power On Self Test) of the BIOS.

Base Memory

The POST of the BIOS will determine the amount of base (or conventional) memory installed in the system.

The value of the base memory is typically 512 K for systems with 512 K memory installed on the motherboard, or 640 K for systems with 640 K or more memory installed on the motherboard.

Extended Memory

The BIOS determines how much extended memory is present during the POST.

This is the amount of memory located above 1 MB in the CPU's memory address map.

Other Memory

This refers to the memory located in the 640 K to 1024 K address space. This is memory that can be used for different applications.

DOS uses this area to load device drivers to keep as much base memory free for application programs. Most use for this area is Shadow RAM.

BIOS Features Setup

AMBIOS SETUP – BIOS FEATURES SETUP	
(C) 1999 American Megatrends, Inc. All Rights Reserved	
1st Boot Device	Floppy
2nd Boot Device	IDE-0
3rd Boot Device	CDROM
S.M.A.R.T. for Hard Disks	Disabled
BootUp Num-Lock	On
Floppy Drive Seek	Enabled
Password Check	Setup
ESC : Quit ↑↓→← : Select Item F1 : Help PU/PD+/- : Modify F5 :Old Values (Shift)F2:Color F6 : Load BIOS Defaults F7 : Load SETUP Defaults	

Figure 3: BIOS Features Setup

- **1st / 2nd / 3rd Boot Device**

Floppy	Boot Device by Floppy.
ZIP A: / LS-120	Boot Device by ZIP A: / LS-120.
CDROM	Boot Device by CDROM.
SCSI	Boot Device by SCSI.
NETWORK	Boot Device by NETWORK.
IDE-0-IDE-3	Boot Device by IDE-0-IDE-3.
Disabled	Boot Device by Disabled.
USB FDD	Boot Device by USB FDD.
ATAPI ZIP C:	Boot Device by ATAPI ZIP C:.

- **S.M.A.R.T. for Hard Disks**

Enabled	Enable S.M.A.R.T. Hard for Disks.
Disabled	Disable S.M.A.R.T. Hard for Disks. (Default Value)

- **Boot Up Num-Lock**

On	Keypad is number keys. (Default Value)
Off	Keypad is arrow keys.

- **Floppy Drive Seek**

During POST, BIOS will determine if the floppy disk drive installed is 40 or 80 tracks. 360 type is 40 tracks while 720 , 1.2 and 1.44 are all 80 tracks.

Enabled	BIOS searches for floppy disk drive to determine if it is 40 or 80 tracks. Note that BIOS can not tell from 720, 1.2 or 1.44 drive type as they are all 80 tracks. (Default Value)
Disabled	BIOS will not search for the type of floppy disk drive by track number. Note that there will not be any warning message if the drive installed is 360.

- **Password Check**

Setup	Set Password Check to Setup. (Default Value)
Always	Set Password Check to Always.

Chipset Features Setup

AMIBIOS SETUP – CHIPSET FEATURES SETUP (C) 1999 American Megatrends, Inc. All Rights Reserved			
*****DRAM Timing***			
Top Performance	Disabled	SDRAM Command Drive	24 mA
DRAM Frequency	100MHz	Memory Address Drive	24 mA
SDRAM CAS# Latency	3	CAS# Drive	12 mA
		RAS# Drive	24 mA
AGP Fast Write	Disabled		
AGP Mode	4X		
AGP Comp. Driving	Auto		
Manual AGP Comp. Driving	DB		
AGP Aperture Size	64MB		
PCI Delay Transaction	Enabled		
USB Controller	Enabled		
USB Legacy Support	Disabled		
USB Port 64/60 Emulation	Disabled		
BIOS Flash Protection	Disabled		
DRAM Drive Strength	Auto	ESC : Quit	↑↓→←: Select Item
MD Bus Strength	High	F1 : Help	PU/PD+/-: Modify
CAS Bus Strength	High	F5 :Old Values	(Shift)F2:Color
Delay DRAM Read Latch	1.0ns	F6 : Load BIOS Defaults	
Memory Data Drive	8 mA	F7 : Load SETUP Defaults	

Figure 4: Chipset Features Setup

- **Top Performance**

If you wish to maximize the performance of your system, set "Top Performance" as "Enabled".

Disabled	Top Performance Disable. (Default Value)
Enabled	Top Performance Enable.

- **DRAM Frequency**

Auto	Set DRAM Frequency to Auto.
100MHz	Set DRAM Frequency to 100MHz. (Default Value)
133MHz	Set DRAM Frequency to 133MHz.

- **SDRAM CAS# Latency**

2	For Fastest SDRAM DIMM module.
3	For Slower SDRAM DIMM module. (Default Value)
Auto	Detect SDRAM CAS# Latency by SPD.

- **AGP Fast Write**

Enabled	Enable this function only if the AGP Card support Fast Write Function. (Enable this function can increase AGP performance).
Disabled	Disable this function. (Default Value)

- **AGP Mode**

4X	Set AGP Mode to 4X. (Default Value)
1X	Set AGP Mode to 1X.
2X	Set AGP Mode to 2X.

- **AGP Comp. Driving**

Auto	Set AGP Comp. Driving to Auto. (Default Value)
Manual	Set AGP Comp. Driving to Manual.

If AGP Comp. Driving is Manual.

Manual AGP Comp. Driving:	00-FF
---------------------------	-------

- **AGP Aperture Size**

4MB	Set AGP Aperture Size to 4MB.
8MB	Set AGP Aperture Size to 8 MB.
16MB	Set AGP Aperture Size to 16 MB.
32MB	Set AGP Aperture Size to 32 MB.
64MB	Set AGP Aperture Size to 64 MB. (Default Value)
128MB	Set AGP Aperture Size to 128 MB.
256MB	Set AGP Aperture Size to 256 MB.

- **PCI Delay Transaction**

Enabled	Enable Delay Transaction. (Default Value)
Disabled	Disable Delay Transaction.

- **USB Controller**

Enabled	Enable USB Controller. (Default Value)
Disabled	Disable USB Controller.

- **USB Legacy Support**

Keyboard/FDD	Set USB Legacy Support Keyboard / Floppy.
KB/Mouse/FDD	Set USB Legacy Support Keyboard / Mouse /Floppy.
Disabled	Disable USB Legacy Support Function. (Default Value)

- **USB Port 64/60 Emulation**

Enabled	To use USB mouse under Win NT environment, set USB Legacy Support to KB/Mouse/FDD and USB Port 64/60 Emulation to enabled.
Disabled	Disable this Function. (Default Value)

- **BIOS Flash Protection**

Enabled	BIOS Flash Write Protection.
Disabled	Normal. (Default Value)

- **DRAM Drive Strength**

Auto	Set DRAM Drive Strength Auto. (Default Value)
Manual	Set DRAM Drive Strength Manual.

If DRAM Drive Strength is Manual, then you can adjust item below.

- **MD Bus Strength**

High	Set MD Bus Strength High. (Default Value)
Low	Set MD Bus Strength Low.

- **CAS Bus Strength**

High	Set CAS Bus Strength High. (Default Value)
Low	Set CAS Bus Strength Low.

- **Delay DRAM Read Latch**

1.0ns	Set DRAM Read Latch Delay 1.0ns. (Default Value)
1.5ns	Set DRAM Read Latch Delay 1.5ns.
0.5ns	Set DRAM Read Latch Delay 0.5ns.
No delay	Set DRAM Read Latch No delay.

- **Memory Data Drive**

6 mA	Set Memory Data Drive 6 mA.
8 mA	Set Memory Data Drive 8 mA. (Default Value)

- **SDRAM Command Drive**

16 mA	Set SDRAM Command Drive 16 mA.
24 mA	Set SDRAM Command Drive 24 mA. (Default Value)

- **Memory Address Drive**

16 mA	Set Memory Address Drive 16 mA.
24 mA	Set Memory Address Drive 24 mA. (Default Value)

- **CAS# Drive**

8 mA	Set CAS# Drive 8 mA.
12 mA	Set CAS# Drive 12 mA. (Default Value)

- **RAS# Drive**

16 mA	Set RAS# Drive 16 mA.
24 mA	Set RAS# Drive 24 mA. (Default Value)

Power Management Setup

AMIBIOS SETUP – POWER MANAGEMENT SETUP (C) 1999 American Megatrends, Inc. All Rights Reserved			
ACPI Sleep Type	S1/POS	RTC Alarm Date	Every Day
USB Dev Wakeup from S3-S5	Disabled	RTC Alarm Hour	00
Suspend Time Out(Minute)	Disabled	RTC Alarm Minute	00
Display Activity	Ignore	RTC Alarm Second	00
IRQ3	Monitor		
IRQ4	Monitor		
IRQ5	Ignore		
IRQ7	Monitor		
IRQ9	Ignore		
IRQ10	Ignore		
IRQ11	Ignore		
IRQ13	Ignore		
IRQ14	Monitor		
IRQ15	Ignore		
Soft-Off by Power Button	Instant-Off		
System after AC Back	Soft-Off	ESC : Quit	↑↓→←: Select Item
Modem Use IRQ	4	F1 : Help	PU/PD+/-: Modify
Resume On Ring/LAN	Enabled	F5 :Old Values	(Shift)F2:Color
PME Event Wake Up	Enabled	F6 : Load BIOS Defaults	
Resume On RTC Alarm	Disabled	F7 : Load SETUP Defaults	

Figure 5: Power Management Setup

- **ACPI Sleep Type**

S1/POS	Set ACPI sleep type to S1. (Default Value)
S3/STR	Set ACPI sleep type to S3.

- **USB Dev Wakeup from S3-S5**

Enabled	Enable USB Dev Wakeup from S3-S5.
Disabled	Disable USB Dev Wakeup from S3-S5. (Default Value)

- **Suspend Time Out (Minute.)**

Disabled	Disable Suspend Time Out Function. (Default Value)
1	Enable Suspend Time Out after 1min.
2	Enable Suspend Time Out after 2min.
4	Enable Suspend Time Out after 4min.
8	Enable Suspend Time Out after 8min.
10	Enable Suspend Time Out after 10min.
20	Enable Suspend Time Out after 20min.
30	Enable Suspend Time Out after 30min.
40	Enable Suspend Time Out after 40min.

50	Enable Suspend Time Out after 50min.
60	Enable Suspend Time Out after 60min.

- **Display Activity**

Ignore	Ignore Display Activity. (Default Value)
Monitor	Monitor Display Activity.

- **IRQ 3-IRQ15**

Ignore	Ignore IRQ3 -IRQ15.
Monitor	Monitor IRQ3-IRQ15.

- **Soft-off by Power Button**

Instant-off	The user press the power button once, he can turn off the system. (Default Value)
Delay 4 sec	Press power button 4 sec to Power off. Enter suspend if button is pressed less than 4 sec.

- **System after AC Back**

Memory	When AC-power back to the system, the system will return to the Last state before AC-power off.
Soft-Off	When AC-power back to the system, the system will be in "Off" state. (Default Value)
Full-On	When AC-power back to the system, the system will be in "On" state.

- **Modem USE IRQ**

3, 4, (Default Value) 5, 7, N/A
--

- **Resume On Ring / LAN**

Disabled	Disable Resume On Ring / LAN.
Enabled	Enable Resume On Ring / LAN. (Default Value)

- **PME Event Wake Up**

Disabled	Disable PME Event Wake Up.
Enabled	Enable PME Event Wake Up. (Default Value)

- **Resume On RTC Alarm**

You can set "Resume On RTC Alarm" item to enabled and key in Data/time to power on system.

Disabled	Disable this function. (Default Value)
Enabled	Enable alarm function to POWER ON system.

If the "Resume On RTC Alarm" is Enabled.

RTC Alarm Date:	Every Day, 1~31
RTC Alarm Hour:	0~23
RTC Alarm Minute:	0~59
RTC Alarm Second:	0~59

PNP/PCI Configurations

AMIBIOS SETUP – PNP / PCI CONFIGURATION (C) 1999 American Megatrends, Inc. All Rights Reserved		
PnP OS Installed	No	ESC: Quit ↑↓→←: Select Item F1 : Help PU/PD+/-/: Modify F5 :Old Values (Shift)F2:Color F6 : Load BIOS Defaults F7 : Load SETUP Defaults
Reset Configuration Data	No	
VGA Boot from	AGP	
PCI AGP Palette Snoop	Disabled	
PCI Slot 1/5 IRQ Priority	Auto	
PCI Slot 2 IRQ Priority	Auto	
PCI Slot 3 IRQ Priority	Auto	
PCI Slot 4 IRQ Priority	Auto	
IRQ 3	PCI/PnP	
IRQ 4	PCI/PnP	
IRQ 5	PCI/PnP	
IRQ 7	PCI/PnP	
IRQ 9	PCI/PnP	
IRQ 10	PCI/PnP	
IRQ 11	PCI/PnP	
IRQ 14	PCI/PnP	
IRQ 15	PCI/PnP	

Figure 6: PNP/PCI Configuration

- **PnP OS Installed**

Yes	Enable PNP OS Installed function.
No	Disable PNP OS Installed function. (Default Value)

- **Reset Configuration Data**

No	Disable this function. (Default Value)
Yes	Clear PnP information in ESCD & update DMI data.

- **VGA Boot From**

AGP	Primary Graphics Adapter From AGP. (Default Value)
PCI	Primary Graphics Adapter From PCI.

- **PCI/VGA Palette Snoop**

Enabled	For having Video Card on ISA Bus and VGA Card on PCI Bus.
Disabled	For VGA Card only. (Default Value)

- **PCI Slot 1,5 IRQ Priority**

Auto	The system will reserved a free IRQ for PCI slot 1 & 5 device. (Default Value)
3	The system will reserved IRQ3 for PCI slot 1 & 5 device if no legacy ISA device using IRQ3.
4	The system will reserved IRQ4 for PCI slot 1 & 5 device if no legacy ISA device using IRQ4.
5	The system will reserved IRQ5 for PCI slot 1 & 5 device if no legacy ISA device using IRQ5.
7	The system will reserved IRQ7 for PCI slot 1 & 5 device if no legacy ISA device using IRQ7.
9	The system will reserved IRQ9 for PCI slot 1 & 5 device if no legacy ISA device using IRQ9.
10	The system will reserved IRQ10 for PCI slot 1 & 5 device if no legacy ISA device using IRQ10.
11	The system will reserved IRQ11 for PCI slot 1 & 5 device if no legacy ISA device using IRQ11.

- **PCI Slot 2 / 3 / 4 IRQ Priority**

Auto	The system will reserved a free IRQ for PCI slot 2 / 3 / 4 device. (Default Value)
3	The system will reserved IRQ3 for PCI slot 2 / 3 / 4 device if no legacy ISA device using IRQ3.
4	The system will reserved IRQ for PCI slot 2 / 3 / 4 device if no legacy ISA device using IRQ4.
5	The system will reserved IRQ5 for PCI slot 2 / 3 / 4 device if no legacy ISA device using IRQ5.
7	The system will reserved IRQ7 for PCI slot 2 / 3 / 4 device if no legacy ISA device using IRQ7.
9	The system will reserved IRQ9 for PCI slot 2 / 3 / 4 device if no legacy ISA device using IRQ9.
10	The system will reserved IRQ10 for PCI slot 2 / 3 / 4 device if no legacy ISA device using IRQ10.
11	The system will reserved IRQ11 for PCI slot 2 / 3 / 4 device if no legacy ISA device using IRQ11.

- **IRQ (3, 4, 5, 7, 9, 10, 11, 14, 15)**

ISA/EISA	The resource is used by Legacy ISA device.
PCI/PnP	The resource is used by PCI/ PnP device.

Load BIOS Defaults

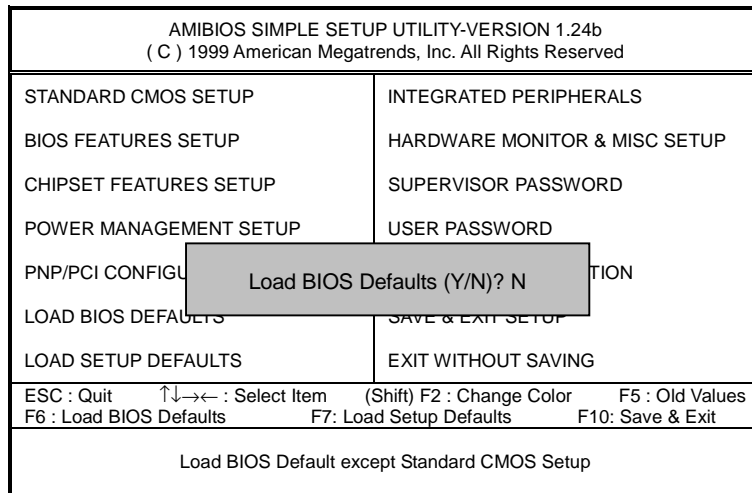

Figure 7: Load BIOS Defaults

- **Load BIOS Defaults**

BIOS defaults contain the most appropriate values of the system parameters that allow minimum system performance.

Load Setup Defaults

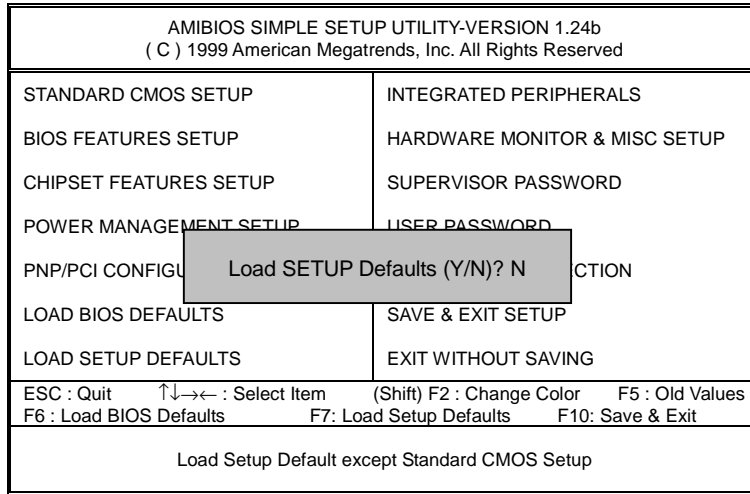

Figure 8: Load Setup Defaults

- **Load Setup Defaults**

Selecting this field loads the factory defaults for BIOS and Chipset Features which the system automatically detects.

Integrated Peripherals

AMIBIOS SETUP – INTEGRATED PERIPHERALS		(C) 1999 American Megatrends, Inc. All Rights Reserved	
OnBoard IDE	Both		
OnBoard Serial Port A	Auto		
OnBoard Serial Port B	Auto		
Serial PortB Mode	Normal		
*Duplex Mode	N/A		
OnBoard Parallel Port	Auto		
Parallel Port Mode	ECP		
Parallel Port DMA	Auto		
Parallel Port IRQ	Auto		
AC97 Audio	Auto		
MC97 Modem	Auto		
◆ OnBoard Legacy Audio	Enabled		
◆ Sound Blaster	Disabled		
◆ SB I/O Base Address	220h-22Fh		
◆ SB IRQ Select	5	ESC: Quit	↑↓→←: Select Item
◆ SB DMA Select	1	F1 : Help	PU/PD+/-/: Modify
◆ MPU-401	Disabled	F5 :Old Values	(Shift)F2:Color
◆ MPU-401 I/O Address	330h-333h	F6 : Load BIOS Defaults	
◆ Game Port(200h-207h)	Enabled	F7 : Load SETUP Defaults	

Figure 9: Integrated Peripherals

*This item will be available when "Serial PortB Mode" is set to IrDA or ASK IR.

◆ These eight items will not be shown when there is sound chip onboard.

- **OnBoard IDE**

Disabled	Disable OnBoard IDE.
Both	Both Primary & Secondary IDE channel will be enabled. (Default Value)
Primary	Only Primary IDE channel is enable.
Secondary	Only Secondary IDE channel is enable.

- **OnBoard Serial Port A**

Auto	BIOS will automatically setup the port A address. (Default Value)
3F8/COM1	Enable OnBoard Serial port A and address to 3F8.
2F8/COM2	Enable OnBoard Serial port A and address to 2F8.
3E8/COM3	Enable OnBoard Serial port A and address to 3E8.
2E8/COM4	Enable OnBoard Serial port A and address to 2E8.
Disabled	Disable OnBoard Serial port A.

- **OnBoard Serial Port B**

Auto	BIOS will automatically setup the port B address. (Default Value)
3F8/COM1	Enable OnBoard Serial port B and address to 3F8.
2F8/COM2	Enable OnBoard Serial port B and address to 2F8.
3E8/COM3	Enable OnBoard Serial port B and address to 3E8.
2E8/COM4	Enable OnBoard Serial port B and address to 2E8.
Disabled	Disable OnBoard Serial port B.

- **Serial Port B Mode**

Normal	Normal operation. (Default Value)
IrDA	Onboard I/O chip supports IRDA
ASK IR	Onboard I/O chip supports ASK IR.

- **Duplex Mode**

Half Duplex	IR Function Duplex Half.
N/A	Disable this function. (Default Value)
Full Duplex	IR Function Duplex Full.

- **OnBoard Parallel port**

378	Enable OnBoard LPT port and address to 378.
278	Enable OnBoard LPT port and address to 278.
3BC	Enable OnBoard LPT port and address to 3BC.
Auto	Set OnBoard LPT port to Auto. (Default Value)
Disabled	Disable OnBoard LPT port.

- **Parallel Port Mode**

EPP	Using Parallel port as Enhanced Parallel Port.
ECP	Using Parallel port as Extended Capabilities Port. (Default Value)
Normal	Normal Operation.
EPP+ECP	Using Parallel port as Enhanced Parallel Port & Extended Capabilities Port.

- **Parallel Port DMA**

Auto	Set Auto to parallel port mode DMA Channel. (Default Value)
3	Set Parallel Port DMA to 3.
1	Set Parallel Port DMA to 1.
0	Set Parallel Port DMA to 0.

● **Parallel Port IRQ**

7	Set Parallel Port IRQ to 7.
Auto	Set Auto to parallel Port IRQ DMA Channel. (Default Value)
5	Set Parallel Port IRQ to 5.

● **AC97 Audio**

Auto	BIOS will search AC97 Codec. If found, AC97 function will be enabled. If no AC97 Codec found, AC97 function will be disabled. (Default Value)
Disabled	Disable On Board AC'97 Audio.

● **MC97 Modem**

Auto	BIOS will search MC97 Codec (AMR Modem Card). If found, MC97 function will be enabled. If no MC97 Codec found, MC97 function will be disabled. (Default Value)
Disabled	Disable On Board MC'97 Modem.

● **OnBoard Legacy Audio**

Enabled	Enable OnBoard Legacy Audio. (Default Value)
Disabled	Disable OnBoard Legacy Audio.

● **Sound Blaster**

Enabled	Enable Sound Blaster.
Disabled	Disable Sound Blaster. (Default Value)

● **SB I/O Base Address**

220h-22Fh	Set SB I/O Base Address to 220h-22Fh. (Default Value)
280h-28Fh	Set SB I/O Base Address to 280h-28Fh.
260h-26Fh	Set SB I/O Base Address to 260h-26Fh.
240h-24Fh	Set SB I/O Base Address to 240h-24Fh.

● **SB IRQ Select**

IRQ 5 / 7 / 9 / 10. (Default Value: 5)

● **SB DMA Select**

DMA 0 / 1 / 2 / 3. (Default Value: 1)
--

- **MPU-401**

Enabled	Enable MPU-401.
Disabled	Disable MPU-401. (Default Value)

Ps. When Force Feedback joystick is used, MPU-401 needs to be Enable.

- **MPU-401 I/O Address**

330h-333h	Set MPU-401 I/O Address to 330h-333h. (Default Value)
300h-303h	Set MPU-401 I/O Address to 300h-303h.
310h-313h	Set MPU-401 I/O Address to 310h-313h.
320h-323h	Set MPU-401 I/O Address to 320h-323h.

- **Game Port (200h-207h)**

Disabled	Disable Game Port (200h-207h).
Enabled	Enable Game Port (200h-207h). (Default Value)

Hardware Monitor & MISC Setup

AMIBIOS SETUP – HARDWARE MONITOR & MISC SETUP (C) 1999 American Megatrends, Inc. All Rights Reserved	
ACPI Shut Down Temp.	Disabled
CPU Temperature	32°C/89°F
System Temperature	32°C/89°F
CPU Fan Speed	7123 RPM
System Fan Speed	0 RPM
Vcore	1.76 V
Vdd	3.33 V
Vcc3	3. 27 V
+5.000V	4.97 V
+12.000V	12.18 V
ESC: Quit ↑↓→←: Select Item F1 : Help PU/PD+/-/: Modify F5 :Old Values (Shift)F2:Color F6 : Load BIOS Defaults F7 : Load Setup Defaults	

Figure 10: Hardware Monitor & MISC Setup

- **ACPI Shutdown Temp. (°C / °F)**

(This function will be effective only for the operating systems that support ACPI Function.)

Disabled	Disable ACPI Shutdown function. (Default Value)
60°C / 140°F	Monitor CPU Temp. at 60°C / 140°F, if Temp. > 60°C / 140°F system will automatically power off.
70°C / 158°F	Monitor CPU Temp. at 70°C / 158°F, if Temp. > 70°C / 158°F system will automatically power off.
80°C / 176°F	Monitor CPU Temp. at 80°C / 176°F, if Temp. > 80°C / 176°F system will automatically power off.
90°C / 194°F	Monitor CPU Temp. at 90°C / 194°F, if Temp. > 90°C / 194°F system will automatically power off.

- **CPU Temperature (°C / °F)**

Detect CPU Temperature automatically.

- **System Temperature (°C / °F)**

Detect System Temperature automatically.

- **CPU Fan Speed**
Detect CPU Fan speed status automatically.
- **System Fan Speed**
Detect System Fan speed status automatically.
- **Voltage (V) Vcore / Vdd / Vcc3 / +5V / +12V**
Detect system's voltage status automatically.

Set Supervisor / User Password

When you select this function, the following message will appear at the center of the screen to assist you in creating a password.

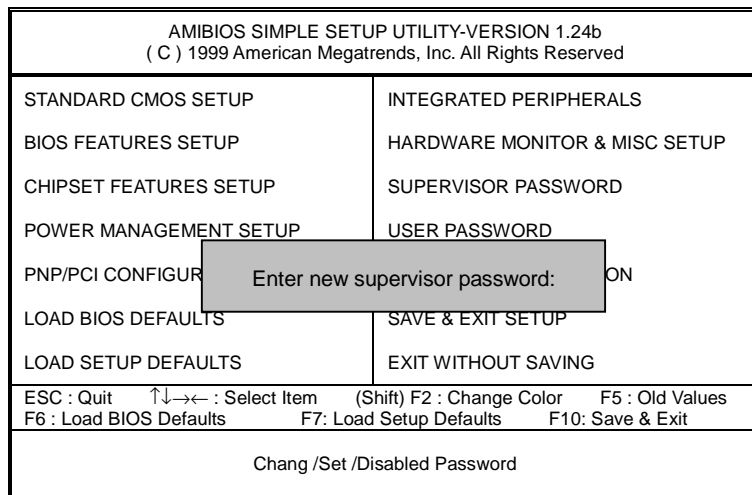

Figure 11: Password Setting

Type the password, up to six characters, and press <Enter>. You will be asked to confirm the password. Type the password again and press <Enter>. You may also press <Esc> to abort the selection and not enter a password.

To disable password, just press <Enter> when you are prompted to enter password. A message "PASSWORD DISABLED" will appear to confirm the password being disable. Once the password is disable, the system will boot and you can enter Setup freely.

The BIOS Setup program allows you to specify two separate passwords: a **SUPERVISOR PASSWORD** and a **USER PASSWORD**. When disable, anyone may access all BIOS Setup program function. When enable, the Supervisor password is required for entering the BIOS Setup program and having full configuration fields, the User password is required to access only basic items.

If you select "Always" at "Password Check" in BIOS Features Setup Menu, you will be prompted for the password every time the system is rebooted or any time you try to enter Setup Menu.

If you select "Setup" at "Password Check" in BIOS Features Setup Menu, you will be prompted only when you try to enter Setup.

IDE HDD AUTO Detection

AMBIOS SETUP – STANDARD CMOS SETUP (C) 1999 American Megatrends, Inc. All Rights Reserved							
Date (mm/dd/yyyy) : Fri Mar 9, 2001 Time (hh/mm/ss) : 10:36:24							
TYPE	SIZE	CYLS	HEAD	PRECOMP	LANDZ	SECTOR	MODE
Pri Master : Not Installed Pri Slave : Not Installed Sec Master : Not Installed Sec Slave : Not Installed							
Floppy Drive A: 1.44 MB 3 ½ Floppy Drive B: Not Installed				Base Memory : 640 Kb Other Memory: 384 Kb Extended Memory: 127Mb Total Memory: 128Mb			
Boot Sector Virus Protection: Disabled							
Month: Jan – Dec Day: 01 – 31 Year: 1990– 2099				ESC : Exit ↑↓ : Select Item PU/PD/+/- : Modify (Shift)F2 : Color			

Figure 12: IDE HDD Auto Detection

Type "Y" will accept the H.D.D. parameter reported by BIOS.

Type "N" will keep the old H.D.D. parameter setup. If the hard disk cylinder number is over 1024, then the user can select LBA mode or LARGER mode for DOS partition larger than 528 MB.

Save & Exit Setup

AMIBIOS SIMPLE SETUP UTILITY-VERSION 1.24b (C) 1999 American Megatrends, Inc. All Rights Reserved	
STANDARD CMOS SETUP	INTEGRATED PERIPHERALS
BIOS FEATURES SETUP	HARDWARE MONITOR & MISC SETUP
CHIPSET FEATURES SETUP	SUPERVISOR PASSWORD
POWER MANAGEMENT SETUP	USER PASSWORD
PNP/PCI CONFIGURATION	
LOAD BIOS DEFAULTS	SAVE to CMOS and EXIT(Y/N)? Y
LOAD SETUP DEFAULTS	EXIT WITHOUT SAVING
ESC : Quit ↑↓→← : Select Item (Shift) F2 : Change Color F5 : Old Values F6 : Load BIOS Defaults F7: Load Setup Defaults F10: Save & Exit	
Save Data to CMOS & Exit Setup	

Figure 13: Save & Exit Setup

Type "Y" will quit the Setup Utility and save the user setup value to RTC CMOS.

Type "N" will return to Setup Utility.

Exit Without Saving

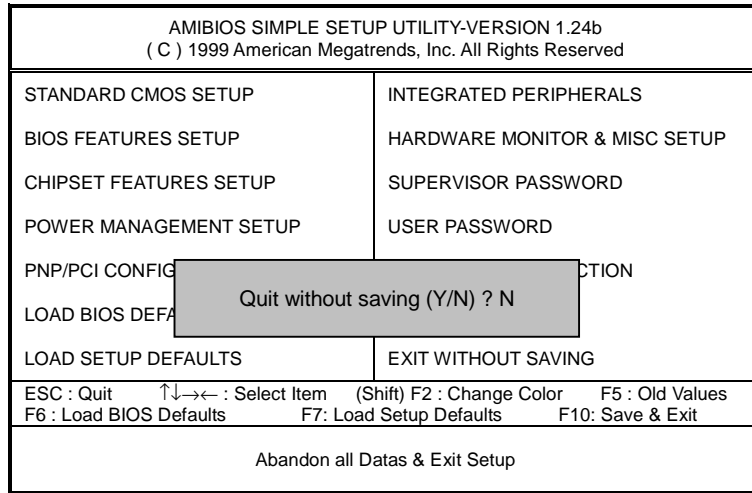

Figure 14: Exit Without Saving

Type "Y" will quit the Setup Utility without saving to RTC CMOS.

Type "N" will return to Setup Utility.

Appendix

Appendix A: VIA KT133/KM133 Chipsets Driver Installation

Insert the support CD that came with your motherboard into your CD-ROM driver or double-click the CD driver icon in My Computer to bring up the screen.

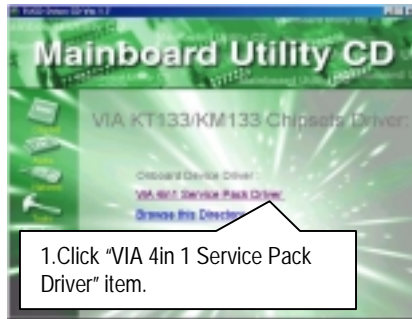

(1)

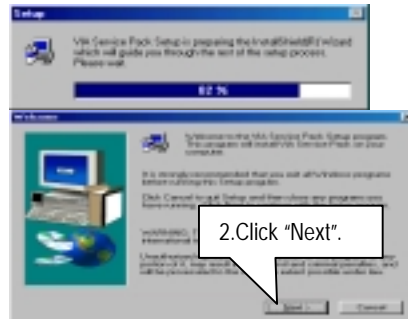

(2)

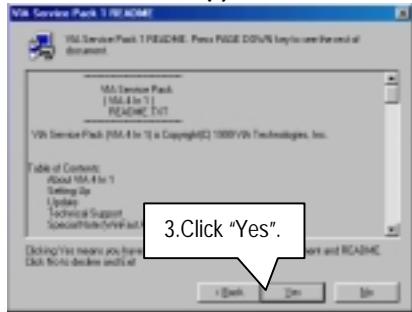

(3)

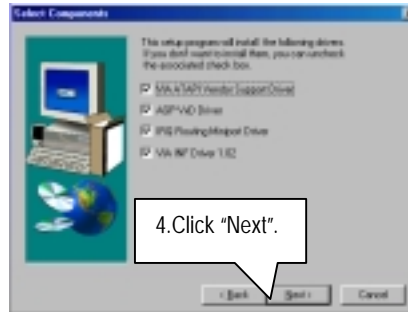

(4)

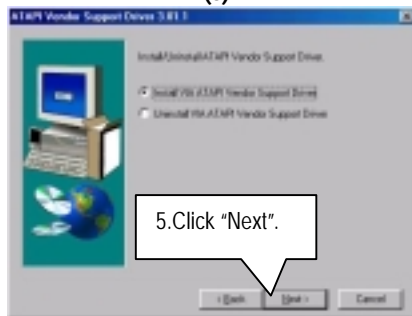

(5)

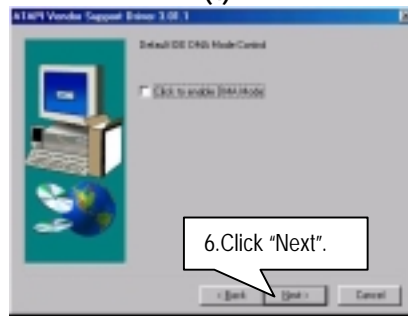

(6)

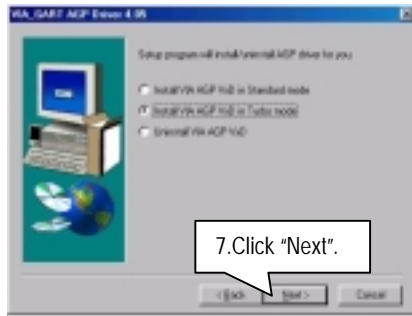

(7)

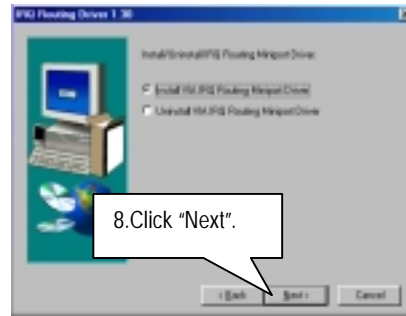

(8)

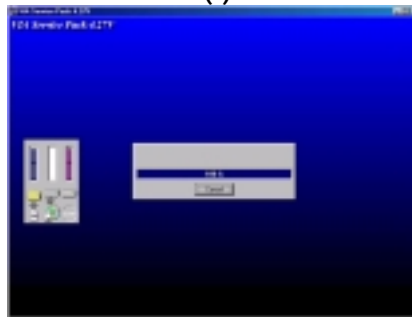

(9)

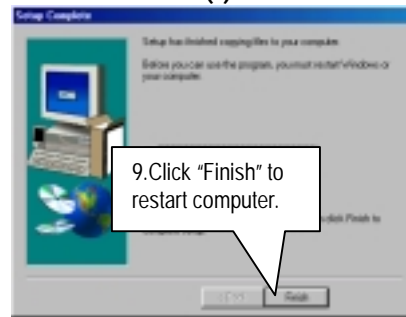

(10)

Appendix B: VIA AC'97 Audio Driver

Insert the support CD that came with your motherboard into your CD-ROM driver or double-click the CD driver icon in My Computer to bring up the screen.



(1)



(2)

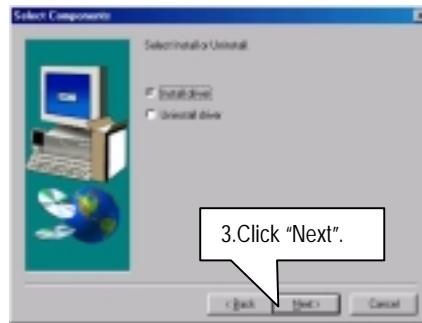

(3)

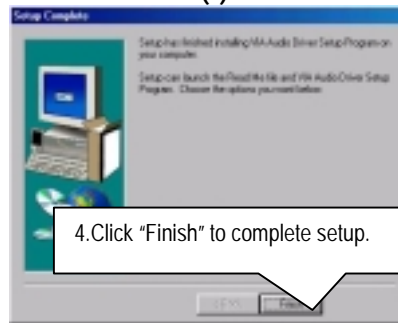

(4)

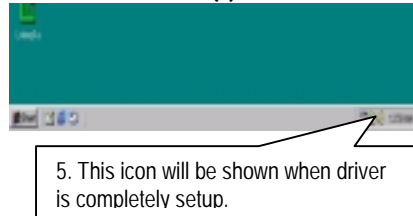

(5)

Appendix C: EasyTuneIII Utilities Installation

Insert the support CD that came with your motherboard into your CD-ROM driver or double-click the CD driver icon in My Computer to bring up the screen.

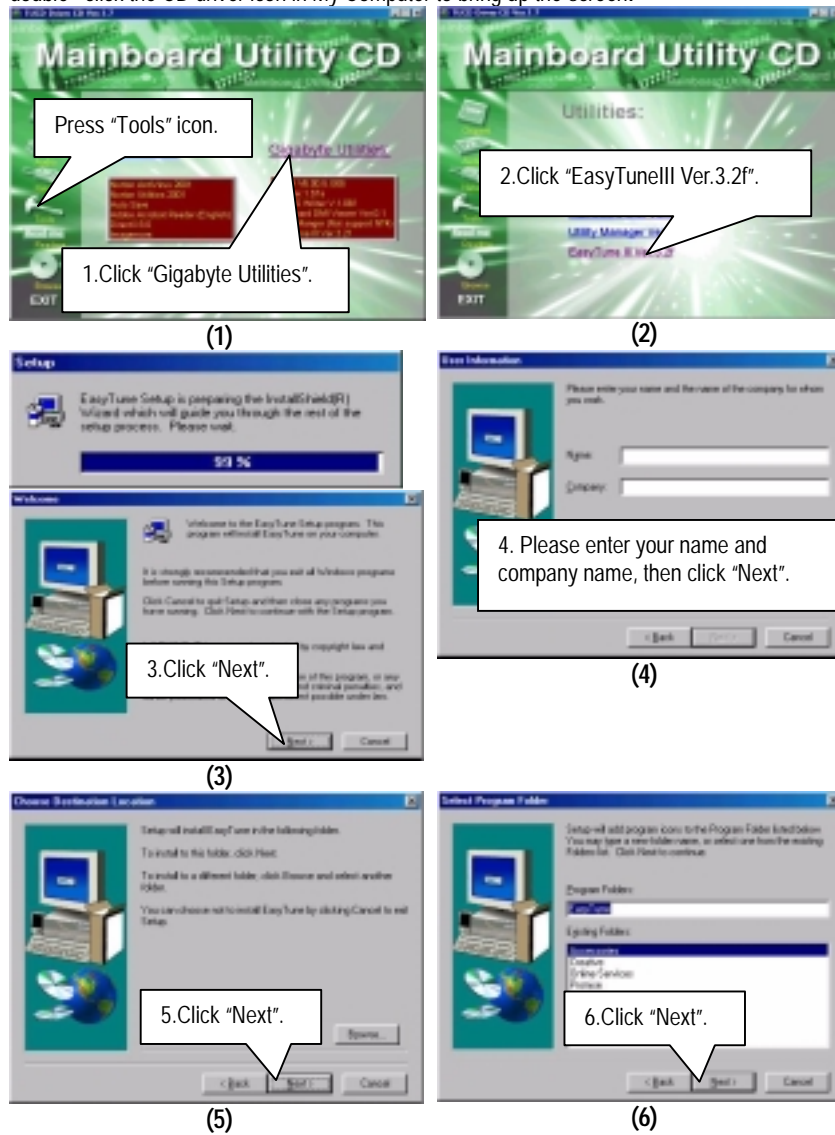

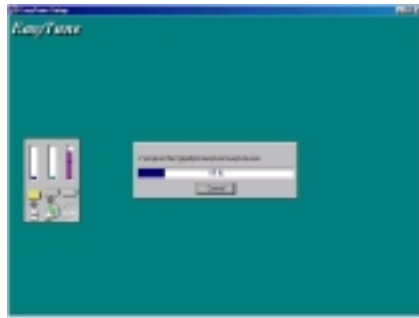

(7)

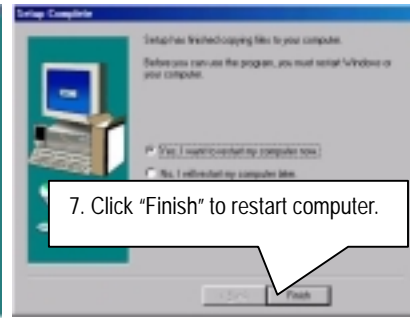

(8)

Appendix D: BIOS Flash Procedure

BIOS update procedure:

If your OS is Win9X, we recommend that you used Gigabyte @BIOS Program to flash BIOS.

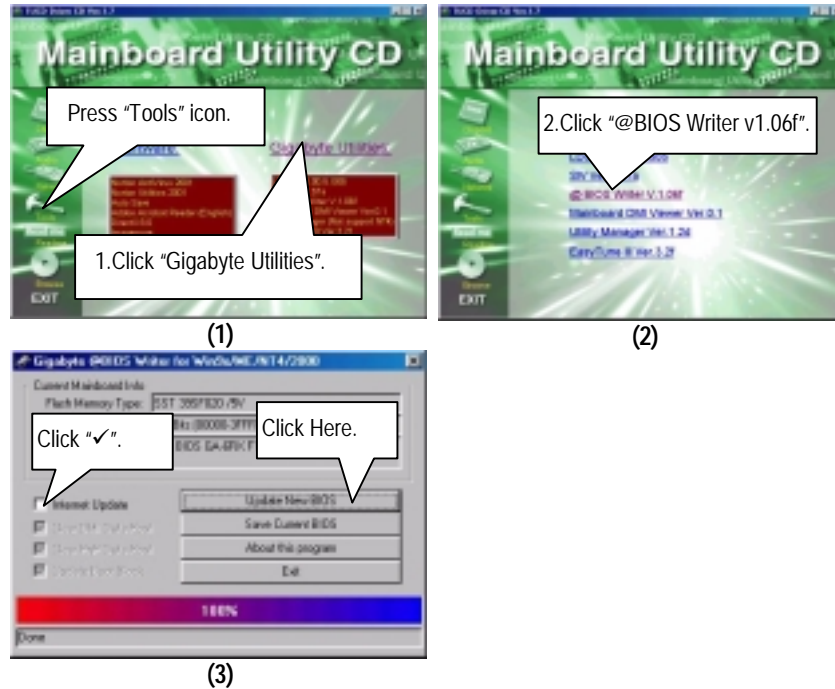

Methods and steps:

- I. Update BIOS through Internet
 - a. Click "Internet Update" icon
 - b. Click "Update New BIOS" icon
 - c. Select @BIOS sever ("Gigabyte @BIOS sever 1 in Taiwan" and "Gigabyte @BIOS sever 2 in Taiwan" are available for now, the others will be completed soon)
 - d. Select the exact model name on your motherboard
 - e. System will automatically download and update the BIOS.

II. Update BIOS **NOT** through Internet:

- a. **Do not** click "Internet Update" icon
- b. Click "Update New BIOS"
- c. Please select "All Files" in dialog box while opening the old file.
- d. Please search for BIOS unzip file, downloading from internet or any other methods (such as: 7ZX-H.F1).
- e. Complete update process following the instruction.

III. Save BIOS

In the very beginning, there is "Save Current BIOS" icon shown in dialog box. It means to save the current BIOS version.

IV. Check out supported motherboard and Flash ROM:

In the very beginning, there is "About this program" icon shown in dialog box. It can help you check out which kind of motherboard and which brand of Flash ROM are supported.

Note:

- a. In method I, if it shows two or more motherboard's model names to be selected, please make sure your motherboard's model name again. Selecting name will cause the system unbooted.
- b. In method II, be sure that motherboard's model name in BIOS unzip file are the same as your motherboard's. Otherwise, your system won't boot.
- c. In method I, if the BIOS file you need cannot be found in @BIOS server, please go onto Gigabyte's web site for downloading and updating it according to method II.
- d. Please note that any interruption during updating will cause system unbooted

Or else you can select flash BIOS in DOS mode.

☛ Please check your **BIOS vendor (AMI or AWARD)**, your **motherboard name** and **PCB version** on the motherboard.

1. Format a bootable system floppy diskette by the command "**format a:/s**" in command mode.
2. Visit the Gigabyte website at [http:// www.gigabyte.com.tw](http://www.gigabyte.com.tw) , Select the BIOS file you need and download it to your bootable floppy diskette.
3. Insert the bootable diskette containing the BIOS file into the floppy diskette driver.
4. Assuming that the floppy diskette driver is A, reboot the system by using the A: driver. At the A: > prompt, run the BIOS upgraded file by executing the Flash BIOS utility and the BIOS file with its appropriate extension.

Example: *(AMI tool) (Where 7zx-h.f1 is name of the BIOS file name)*

A:>flashxxx.exe 7zx-h.f1 ↵

Example: *(Award tool) (Where 7zx-h.f1 is name of the BIOS file name)*

A:>Awdflash.exe 7zx-h.f1 ↵

5. Upon pressing the <Enter> key, a flash memory writer menu will appear on screen. Enter the new BIOS file name with its extension filename into the text box after file name to program.
6. If you want to save the old BIOS file(perform as soon as system is operational, this is recommended), select Y to **DO YOU WANT TO SAVE BIOS**, then type the old BIOS filename and the extension after filename to save: This option allows you to copy the contents of the flash memory chip onto a diskette, giving you a backup copy of the original motherboard BIOS in case you need to re-install it. Select N to **DO YOU WANT TO SAVE BIOS**, if you don't want to save the old BIOS file.
7. After the decision to save the old BIOS file or not is made, select Y to **ARE YOU SURE TO PROGRAM** when the next menu appear; wait until a message showing Power Off or Reset the system appears. Then turn off your system.
8. Remove the diskette and restart your system.
9. Hold down <Delete> key to enter BIOS setup. You must select "Load Setup BIOS Default" to activate the new BIOS, then you may set other item from the main menu.

Appendix E: Acronyms

Acronyms	Meaning
ACPI	Advanced Configuration and Power Interface
APM	Advanced Power Management
AGP	Accelerated Graphics Port
AMR	Audio Modem Riser
ACR	Advanced Communications Riser
BIOS	Basic Input / Output System
CPU	Central Processing Unit
CMOS	Complementary Metal Oxide Semiconductor
CRIMM	Continuity RIMM
CNR	Communication and Networking Riser
DMA	Direct Memory Access
DMI	Desktop Management Interface
DIMM	Dual Inline Memory Module
DRM	Dual Retention Mechanism
DRAM	Dynamic Random Access Memory
DDR	Double Data Rate
ECP	Extended Capabilities Port
ESCD	Extended System Configuration Data
ECC	Error Checking and Correcting
EMC	Electromagnetic Compatibility
EPP	Enhanced Parallel Port
ESD	Electrostatic Discharge
FDD	Floppy Disk Device
FSB	Front Side Bus
HDD	Hard Disk Device
IDE	Integrated Dual Channel Enhanced
IRQ	Interrupt Request
I/O	Input / Output
IOAPIC	Input Output Advanced Programmable Input Controller
ISA	Industry Standard Architecture
LAN	Local Area Network
LBA	Logical Block Addressing
LED	Light Emitting Diode
MHz	Megahertz
MIDI	Musical Interface Digital Interface
MTH	Memory Translator Hub
MPT	Memory Protocol Translator
NIC	Network Interface Card
OS	Operating System

To be continued...

Acronyms	Meaning
OEM	Original Equipment Manufacturer
PAC	PCI A.G.P. Controller
POST	Power-On Self Test
PCI	Peripheral Component Interconnect
RIMM	Rambus in-line Memory Module
SCI	Special Circumstance Instructions
SECC	Single Edge Contact Cartridge
SRAM	Static Random Access Memory
SMP	Symmetric Multi-Processing
SMI	System Management Interrupt
USB	Universal Serial Bus
VID	Voltage ID