

TYAN S1470
Pentium Class 75 thru 200MHz
430VX PCI-ISA System Board
User's Manual



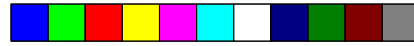
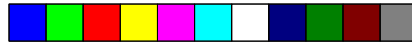

Table Of Contents

1. Introduction.....	3
1.1 Overview.....	3
1.2 Hardware Specifications.....	4
1.3 Software Specifications.....	5
1.4 Environment.....	5
2. Board Installation.....	6
2.1 Unpacking.....	6
2.2 Installation.....	6
3. S1470 On Board Resource Settings.....	7
3.1 S1470 Board Layout & Jumper Locations.....	7
3.2 Quick Reference for Jumpers.....	8
3.3 CMOS RTC.....	12
3.4 Speaker Connector.....	12
3.5 Turbo Switch.....	12
3.6 Turbo LED Connect.....	12
3.7 Reset Connector.....	13
3.8 Flash EPROM Jumpers.....	13
3.9 CMOS & Password Reset.....	13
3.10 DRAM Installation.....	14
3.11 CPU Installation.....	15
3.12 Cache Upgrade.....	16
3.13 Peripheral Device Installation.....	17
3.14 Connecting The Power Supply.....	18
4. BIOS Configuration.....	20
4.1 Entering Setup.....	20
4.2 Control Keys.....	21
4.3 Getting Help.....	22
4.4 The Main Menu.....	22
4.5 Standard CMOS Setup Menu.....	24
4.6 BIOS Features Setup.....	27
4.7 Chipset Features Setup.....	30
4.7.1 Power Management Setup.....	31
4.8 PCI Slot Configuration.....	33
4.9 Integrated Peripherals.....	35
4.10 Load Setup Defaults.....	36
4.11 Password Setting	36
4.12 IDE HDD Auto Detection.....	38
4.13 Save & Exit Setup.....	38
5. Flash Writer Utility.....	39
5.1 The Flash Memory Writer Utility Screen.....	41
6. System Resources.....	42
6.1 Timer & DMA Channel Map.....	42



1. Introduction

1.1 Overview

The S1470 is a quality, high performance mainboard designed for Intel Pentium microprocessors. This mainboard utilizes the Intel 430VX chipset and can support CPU speeds of 75MHz through 200MHz. S1470 will also support the CyrixM1/6x86 CPU's and the Intel multimedia Pentium P55C which utilizes MMX commands.

The S1470's PCI Local Bus provides high performance capabilities that are ideal for a wide range of demanding applications such as: CAD, CAM, CAE, networking, multi-user environments, database management, desktop publishing, image processing and 3D animation.

This integrated system board achieves high reliability with numerous features and yet is small enough to be supported in a "Baby-AT" form-factor. Some of the features included are: on-board dual channel PCI PIO and DMA IDE, on-board floppy controller, on-board high speed I/O, and support for pipeline-burst SRAM.

Flexibility and expandability have been designed into the S1470. With I/O and drive controller support built on-board, the five PCI and four ISA (One ISA and one PCI as a shared slot) slots are free for numerous add-on expansion cards.

Remember to take a look at Tyan Computers web site located at <http://www.tyan.com>. Here you can find information on all of Tyan's products along with FAQ's, distributors list, drivers and CMOS setting explanations. If you have a tech support question please contact us at www.tyan.com.

Notice

This board uses the Intel 430VX chipset. According to Intel, the USB function in this chipset is not guaranteed. Compatibility tests cannot be conducted for USB at this time due to no availability of such devices and drives. Please log on to the Tyan web page for the latest information.

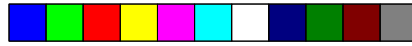

1.2 Hardware Specifications/Features

- ◆ CPU Intel Pentium 75 MHz thru 200 MHz (Socket 7)
Intel Pentium P55C
Cyrix/IBM/SGS M1/6x86 P120, P150 & P166
- ◆ Speed 50/60/66 MHz system bus
25/30/33 MHz PCI bus
7.5/8.33 MHz ISA bus speed
- ◆ DRAM 2 banks of 72 pin SIMM and 2 DIMM Banks
Supports 5V or 3.3V memory
Supports EDO(Exended Data Out) DRAMs
Supports SDRAM(Synchronous DRAM)
Supports Fast Page Mode DRAMs
Supports 8MB to 128MB of DRAMs
- ◆ L2 Cache 16KB cache memory included in Pentium
256/512KB on board 2nd level cache memory
Supports synchronous pipeline-burst
- ◆ EIDE Controller Primary and secondary PCI EIDE channels on board for support of up to four EIDE Mode 0 through Mode 4 drives.
Supports DMA(Bus Master) mode 1 and 2.
(Bus Master driver on web at www.tyan.com)
- ◆ Enhanced I/O Multi-mode bi-directional parallel port that supports standard, EPP and ECP modes.
Supports 16550 compatible Uarts for on-board high speed serial ports.
Support for an IrDA compliant Infra Red interface.
On-board floppy controller
Support for On-board Universal Serial Port
- ◆ I/O Bus Slots 5 Master/Slave PCI-Bus
4 ISA Bus one ISA and one PCI slot is shared for a total of 8 slots.



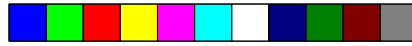

- ◆Mouse On-board PS/2 mouse connector.

1.3 Software Specifications

- ◆BIOS Award or AMI BIOS
AT CMOS setup, BIOS/CHIPSET setup,
and hard disk utility included.
Support for easy BIOS upgrades with flash
EPROM chip.
- ◆O.S. Operates with MS-DOS, Windows 3.x, Windows
for Work Group 3.x, Windows 95, Windows NT
OS/2, Novell Netware, Novell UnixWare1.1, and
SCO Unix.

1.3 Environment

Ambient Temperature	0 to +50 C (operating)
Relative Humidity	0 to +85% (operating)
Altitude	0 to 10,000 feet (operating)
Vibration	0 to 1,000 Hz
Voltage	4.9 to 5.2 V

Information presented in this publication has been carefully checked for reliability; however, no responsibility is assumed for inaccuracies. The information contained in this document is subject to change without notice.

Trademarks

Award BIOS/Flash are trademarks of Award Software International Inc.
AMI BIOS is a trademarks of American Megatrends Inc.
IBM,PC,AT,PS/2 are trademarks of IBM Corporation
INTEL,Pentium are trademarks of Intel Corporation.

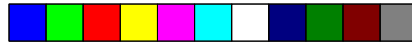

2. Board Installation

2.1 Unpacking

The mainboard package should contain the following:

- ◆S1470 Mainboard
- ◆One IDE 40 pin cables
- ◆Two serial cables
- ◆One parallel cable
- ◆One 34 pin floppy cable
- ◆User's Manual

The mainboard contains sensitive electric components which can be easily damaged by static electricity, so the mainboard should be left in its original packaging until it is ready to be installed.

With the power supply plugged in and turned off touch an unpainted area of the system chassis immediately before handling the mainboard or any component. Doing so discharges the static charge your body may have built.

After opening the mainboard carton, extract the system board holding it by its edges ,and place it only on a grounded anti-static surface, component side up. Inspect the board for damage. Press down on all of the socket IC's to make sure that they are properly seated. Do this only with the board placed on an anti-static mat. Do not touch the bottom of the board.

DO NOT APPLY POWER TO THE BOARD IF IT HAS BEEN DAMAGED!

2.2 Installation

You are now ready to install your mainboard. The mounting hole pattern of the S1470 matches the "Baby AT" system board spec. It is assumed that the chassis is for a standard IBM XT/AT form factor.

3. On Board Resource Setting

Figure 3.1 S1470 Board Layout

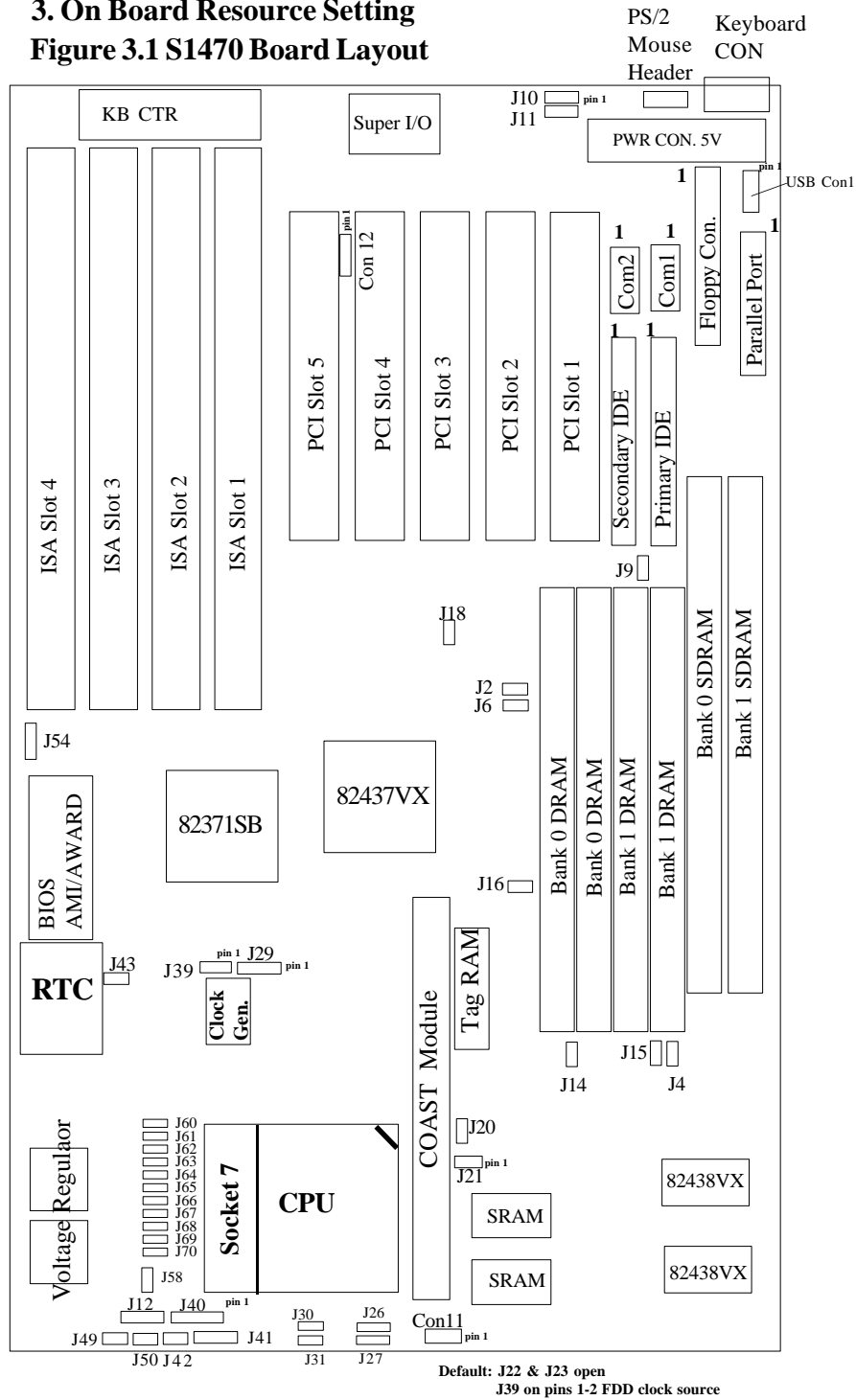

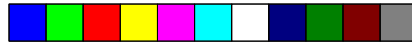

3.2 Jumper Settings

CPU Speed Settings for Pentium P54C and P55C:

J29	J30	J31	CPU Speed
1-2, 3-4	Off	Off	75 MHz
3-4	Off	Off	90 MHz
1-2	Off	Off	100 MHz
3-4	On	Off	120 MHz
1-2	On	Off	133 MHz
3-4	On	On	150 MHz
1-2	On	On	166 MHz
1-2	Off	On	200 MHz

CPU Speed Settings for Cyrix/SGS/IBM 6x86/M1:

J29	J30	J31	CPU Speed	CPU ID
1-2, 3-4	On	Off	100MHz	P120+
3-4	On	Off	120MHz	P150+
1-2	On	Off	133MHz	P166+

CPU Voltage Regulator Settings:

Pentium MMX requires two voltage sources, J60, J61, & J62 are settings for one source. J63, J64 and J65 are settings for the second voltage source. The default setting is for P54C/Cyrix CPU's.

P54C(Pentium) & Cyrix

	3.6V	3.5V	3.3V
J60	on	off	off
J61	off	off	on
J62	off	on	off
J58	off		
J63	off		
J64	off		
J65	off		
J66	Default settings for P54C and Cyrix		
J67	on		
J68	on		
J69	on		
J70	on		

P55C(Pentium MMX)

	3.0V	2.85V	2.65V
J63	off	off	on
J64	off	on	off
J65	on	off	off
J58	on		
J66	on		
J67	off		
J68	off		
J69	off		
J70	off		
	Settings for P55C only		

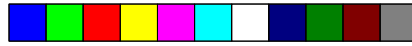

Memory Voltage:5V is the default. Some EDO memory uses 3.3V.

Damage to system can result if these are set incorrectly!

	Volts	J2	J6	J9	J16	J4	J14	J15
Default	5V	On	On	On	On	Off	Off	Off
	3.3V	Off	Off	Off	Off	On	On	On

Tag RAM Setting: J20

J20	
Enable on-board Tag	on
Disable on-board Tag	off
(When using COAST Module with Tag chip)	

SRAM Select: J21

J21	
Use on-board 256Kb SRAM	2-3
Upgrade to 512Kb w/256Kb COAST	1-2

CPU Multiplier: J30 and J31

J30	J31	Multiplier
off	off	x1.5
on	off	x2
on	on	x2.5
off	on	x3

Host Bus Setting: J29

J29	Host Speed	PCI Speed
1-2,3-4	50MHz	25MHz
1-2	66.67MHz	33.33MHz
3-4	60MHz	30MHz



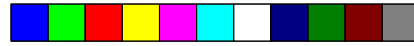

Reset Connector: J49

Pinout Assignment	
1	Power Good
2	Ground

Turbo LED Connector: J50

Pinout Assignment	
1	Cathode
2	Anode

Flash EPROM: J54

This jumper should be left at the factory default.

J54	1-2
-----	-----

Keylock Connector: J40

Pinout Assignments	
1	Led Output
2	No Connect
3	Ground
4	Keylock
5	Ground

CMOS Resest/Password Reset: J43(Default off)

If you at anytime need to reset the CMOS because you have forgotten your password do the following.

If your system has the Dallas **DS12887A** chip, just power down the machine and close jumper J43 for five seconds. Then open the jumper and power on the machine. Your CMOS will be cleared.

If your system has the Dallas **DS12B887** chip, your system must be powered on when you close jumper J43. It only needs to be closed for a couple of seconds. Then remove the jumper and your CMOS will be cleared.

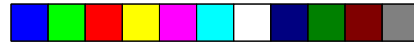

I/O Port Setting: J10 and J11

		J10	J11
Default	For Serial Port	1-2	1-2
	For IR Port	2-3	2-3

Speaker Connector: J41

Pinout Assignments	
1	Speaker out
2	NC
3	Ground
4	+5V

Turbo Switch: J42

Non-Turbo mode
not supported by chipset.

Open for Turbo
Close for Non-Turbo

HDD LED: J12

Pinout Assignments	
1	Cathode
2	Anode
3	Anode
4	Cathode

Infra Red Interface: Con11 and Con12

Pinout	Assignment
1	Signal In
2	Gnd
3	Signal Out
4	VCC

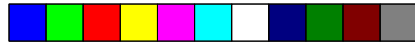

3.3 CMOS RTC

CMOS RTC includes an internal battery and Real Time Clock circuit. It provides the date and the time for the system. Normally the life span of a RTC internal battery is 10 years. When replacing, you should use the same model.

3.4 Speaker Connector Installation

S1470 provides a 4-Pin header (J41) to connect the speaker. The polarity can go either way.

3.5 Turbo Switch

The front panel on your case may have a turbo switch to control system speed when slower program execution is required for software developed in the old XT days.

You can connect the chassis turbo switch to J42 on the mainboard. The 430VX chipset doesn't support a hardware turbo function so this switch will only turn on or off the turbo LED.

3.6 Turbo LED Connector Installation

The TURBO LED on the front case panel can indicate the current speed status of the system. The TURBO LED connector should be installed to J50 in the correct direction.

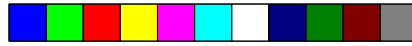

3.7 Hardware Reset Switch Connector Installation

The RESET switch on your cases' display panel provides users with the HARDWARE RESET function which is the same as power on/off. The system will do a cold start after the RESET switch is pushed by the user. The RESET switch is a 2 pin connector and should be installed on jumper J49.

3.8 Flash EPROM-Jumper J54

The S1470 uses flash memory to store BIOS programs. It can be updated as new versions of the BIOS becomes available. The flash utility will guide you through the process step by step.

J54 determines which type of EPROM is used. This jumpers has been set to match the on board BIOS chip. The factory default for the S1470 is on pins 1-2. Depending on the type of EPROM used, some boards will have J54 on pins 2-3.

Refer to chapter 5 for Flash EPROM upgrade procedures.

3.9 Hardware CMOS & Password Reset

(The following steps are valid provided the board has a DS12887A RTC)

If you have been locked out of your system because you forgot your password or set the CMOS incorrectly, follow the instructions below.

- a. Power off the system
- b. Short jumper J43. (Put jumper on it)
- d. Wait for 5 seconds then remove the jumper from J43.
- e. Then power on the system again.

By doing the above procedures, your password will be erased and the CMOS will be reset to the BIOS default.

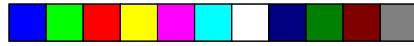

3.10 DRAM Installation

The S1470 uses a 64-bit data path from memory to CPU and can accommodate up to 128 MB of RAM. The mainboard supports Fast Page Mode, and EDO (Extended Data Out) 72 pin SIMMs. SDRAM(Synchronous) are also supported in the DIMM slots. DIMM's must be of the unbuffered variety. All installed memory will be automatically detected so there is no need to set jumpers.

- ◆SIMM modules must be installed in pairs.
- ◆Each pair of SIMMs must be of the same size and type.
- ◆The mainboard supports 1, 2, 4 and 8MBx32 SIMMs.
- ◆SIMM bank 0 and 1 can use either double or single sided SIMMs.
- ◆Two SIMMs or One unbuffered DIMM must be installed for the system to POST.
- ◆SDRAM DIMMs can be installed one at a time.
- ◆The mainboard supports 1, 2 and 4Mx 64 DIMM modules.
- ◆SIMM bank 0 and DIMM bank 0 cannot be used at the same time.
SIMM bank 1 and DIMM bank 1 cannot be used at the same time.
You can use SIMM bank 0 with DIMM bank 1.
You can use SIMM bank 1 with DIMM bank 0.
- ◆The following table shows some of the available memory configurations.

DRAM Bank 0	DRAM Bank 1	SDRAM Bank 0	SDRAM Bank 1	Total
4MB x2	none	none	none	8MB
none	none	8MB x1	none	8MB
none	none	16MB x1	none	16MB
8MB x2	none	none	none	16MB
4MB x2	4MB x2	none	none	16MB
8MB x2	8MB x2	none	none	32MB
16MB x2	none	none	none	32MB
none	none	16MB x1	16MB x 1	32MB
32MB x2	none	none	none	64MB
16MB x2	16MB x2	none	none	64MB
16MB x2	none	none	32MB x1	64MB
none	none	32MB x1	32MB x1	64MB
32MB x2	16MB x2	none	none	96MB
32MB x2	none	none	32MB x1	96MB
32MB x2	32MB x2	none	none	128MB

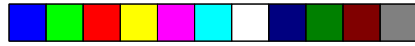

3.11 CPU Installation

Several types of CPUs (75 thru 200MHz) can be used on S1470. Please refer to section 3.2 for the correct CPU jumper settings for your board.

- ◆ The CPU is a sensitive electronic component and it can be easily damaged by static electricity. Do not touch the CPU pins with your fingers.
- ◆ When installing the CPU into the socket, match the CPU pins to the socket pins.
- ◆ Before the CPU is installed, the mainboard must be placed on a flat plane. You should be able to insert the CPU with minimal pressure. Do not push down hard, use firm pressure.
- ◆ **A cooling fan and heat sink assembly is required to protect the CPU from being damaged.**

1. Make sure the ZIF socket lever is up. To raise the lever, pull it out to the side a little and raise it as far as it will go. The top plate will slide back.
2. Align the CPU and socket Pin 1 corners. The pins on the bottom should align with the rows of holes in the socket.
3. Insert the CPU in the socket. It should insert easily. If it does not, adjust the position of the lever a little.
4. Press the lever down. The top plate will slide forward. You will feel some resistance as the pressure starts to secure the CPU in the socket. This is normal and will not damage the CPU. The lever should snap into place at the side of the socket.

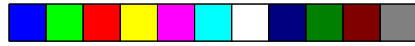

3.12 Upgrading Cache Memory

The S1470 has 256Kb of on-board pipelined burst SRAM and can be upgraded to 512Kb by adding a Tyan approved 256Kb cache module. Please refer to your vendor for the approved upgrade modules.

- ◆ Refer to page 9 for the cache jumper settings.
- ◆ When upgrading to 512Kb cache, you must use a 256Kb "COAST" module and open jumper J20 and set J21 to pins 1-2.
- ◆ Only use Tyan approved 256Kb "COAST" modules when upgrading.
- ◆ The "COAST Module" will only fit in the "Coast Socket" one way and should install easily.
- ◆ You cannot disable the onboard cache and install a 512Kb "COAST" module to get 512Kb of cache. The onboard cache is always used.



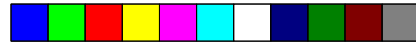

3.13 Peripheral Device Installation

After all the jumpers on the mainboard have been set, then it can be mounted into the case. Then proceed to install the display card and any other peripheral devices.

If a PCI-Bus interface card is to be installed in the system, any one of the five PCI-Bus slots can support either a Master or a Slave device.

After installing the peripheral controllers, the user should check everything again, and prepare to power-on the system.



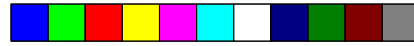

3.16 Connecting the Power Supply

The system power supply connectors on the mainboard is for a 5 volt power supply. Incorrect installation of the power supply could result in serious damage to the system board and connected peripherals.

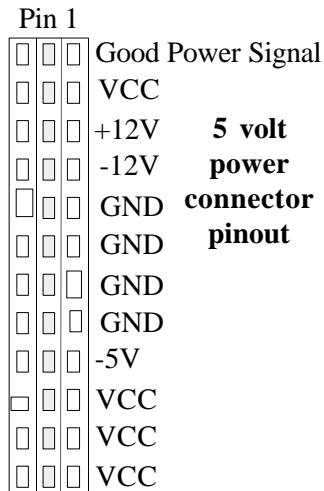

To connect the leads from either voltage power supply, you should first make sure the power supply is unplugged. Most power supplies have two leads. Each lead has six wires, two of which are black.

Orientate the connectors so the black wires are in the middle of the 5V power supply.

Caution: Some power supplies also include "3V" connectors. The connection wires normally have two colors with 3 black wires on one side. Please be very careful. Don't to use the wrong connector.

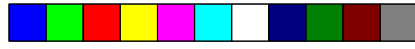

Align the plastic guide pins on the lead cables to their receptacles on the mainboard. You may need to hold the lead at an angle to line it up. Once you have the guide pins aligned, press the lead connector so that the plastic clips on the lead snap into place and secure the lead to the connector.

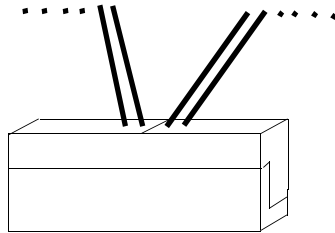

Connecting 5V power supply

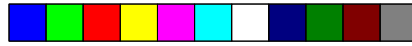

4. BIOS Configuration

Award's BIOS has a built in setup program that allows the user to modify the basic system configuration. This type of information is stored in the battery-backed CMOS SRAM. **Entering incorrect information or forgetting your password can lock you out of your system.(refer to 3.9 for resetting of CMOS)**

4.1. Entering Setup

Power ON the computer and press immediately and you will enter Setup. The other way to enter setup is to power on the computer, when the below message appears briefly at the bottom of the screen during the post (Power On Self Test), press key or simultaneously press <Ctrl>, <Alt>, and <Esc> keys.

* TO ENTER SETUP BEFORE BOOT PRESS CTRL-ALT-ESC OR DEL KEY

If the message disappears before you respond and you wish to enter Setup, restart the system by turning it OFF then ON or by pressing "Reset" on the system case. You may also restart by simultaneously pressing <Ctrl>, <Alt>, and keys. If you do not press the keys at the correct time, the system will not boot and an error message will appear on the screen. You will be asked to,

* PRESS F1 TO CONTINUE, CTRL-ALT-ESC OR DEL TO ENTER SETUP.

Figure 4.1 will appear on the screen. The Main Menu allows you to select from the 8 setup functions and 2 exit choices. Use the arrow keys to select among the items and press <Enter> to accept or enter each sub-menu.

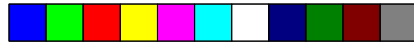

4.2. Control Keys

PgUp key	Increases the numeric value or make changes
PgDn key	Decreases the numeric value or make changes
F1 key	General help, only for Status Page Setup menu and Option Page Setup Menu
F2 key	Change color from a total of 16 colors
F3 key	Calendar, only for Status Page Setup Menu
F4 key	Reserved
F5 key	Restore the previous CMOS value, only for Option Page Setup Menu
F6 key	Load defaults
F8 key	Reserved
F9 key	Reserved
F10 key	Save all CMOS changes, only for Main Menu



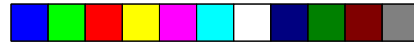

4.3. Getting Help

4.3.1. Main Menu

The on-line description of the highlighted setup function is displayed at the bottom of the screen.

4.3.2. Setup Page menu/Option Page Setup Menu

Press F1 to pop up a small help window that describes the appropriate keys to use and the possible selections for the highlighted items. To exit the Help Window, press <Esc>.

4.4. The Main Menu

Once you enter the Award BIOS CMOS Setup Utility, the Main Menu (Figure 4.1) will appear on the screen. The Main Menu allows you to select from the eight setup functions and 2 exit choices. Use the arrow keys to select among the items and press <Enter> to accept or enter the sub-menu.

Figure 4.1: Main Menu

ROM ISA BIOS (2A59CT51)
CMOS SETUP UTILITY
AWARD SOFTWARE, INC.

STANDARD CMOS SETUP	INTEGRATED PERIPHERAL
BIOS FEATURED SETUP	SUPERVISOR PASSWORD
CHIPSET FEATURES SETUP	USER PASSWORD
POWER MANAGEMENT	IDE HDD AUTO DETECT
PNP/PCI CONFIGURATION	SAVE AND EXIT
LOAD BIOS DEFAULTS	EXIT WITHOUT SAVING
ESC : Save & Exit Setup F10 : Quit	
↑ ↓ → ← :Select Item (Shift)F2 :Change Color	
Time, Date, Hard Disk Type,.....	

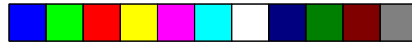

◆ **Standard CMOS setup**

This setup page includes all the items in a standard compatible BIOS.

◆ **BIOS features setup**

This setup page includes all of the enhanced features of Award's BIOS.

◆ **Chipset features setup**

This setup page includes all the items of the 430HX chipset features.

◆ **Power Management setup**

Change, set, or disable system power management options

◆ **PNP/PCI Configuration**

This setup page allows you to modify the configuration of PCI slot parameters.

◆ **Load setup defaults**

BIOS defaults indicate the most appropriate values of each system parameter for your system.

◆ **Supervisor/User Password**

Change, set, or disable password. It allows you to limit access to the system and Setup.

◆ **Integrated Peripherals**

This option lets you enable or disable on board FDD, HDD, and I/O options.

◆ **IDE HDD auto detection**

Automatically configure hard disk parameters.

◆ **Save and exit setup**

Save changes to CMOS and exit setup

◆ **Exit without saving**

Abandon all CMOS changes and exit setup.



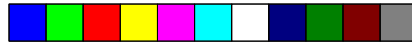

4.5. Standard CMOS Setup Menu

The items in Standard CMOS Setup Menu (Figure 4.2) are divided into 9 categories. Each category includes one or more setup items. Use the arrows to highlight the item and use the <PgUp> or <PgDn> keys to select the value you want for each item.

Figure 4.2: Standard CMOS Setup Menu

ROM ISA BIOS (2A59CT51)																	
STANDARD CMOS SETUP																	
AWARD SOFTWARE, INC.																	
Date (mm:dd:yy) : Tue, Dec 7 1995																	
Time (hh:mm:ss) : 18 : 01 : 38																	
	Type	Size	CYLS.	HEADS.	PRECOMP.	LANDZONE	SECTORS										
Primary Master :	none	0mb	0	0	0	0	0										
Primary Slave:	none	0mb	0	0	0	0	0										
Secondary Master:	none	0mb	0	0	0	0	0										
Secondary Slave:	none	0mb	0	0	0	0	0										
Drive A : 1.44 M, 3.5 in.				<table border="1"> <tr> <td>Base Memory:</td> <td>640 K</td> </tr> <tr> <td>Extended Memory:</td> <td>7168 K</td> </tr> <tr> <td>Expanded Memory:</td> <td>0 K</td> </tr> <tr> <td>Other Memory:</td> <td>384 K</td> </tr> <tr> <td>Total Memory:</td> <td>8192 K</td> </tr> </table>				Base Memory:	640 K	Extended Memory:	7168 K	Expanded Memory:	0 K	Other Memory:	384 K	Total Memory:	8192 K
Base Memory:	640 K																
Extended Memory:	7168 K																
Expanded Memory:	0 K																
Other Memory:	384 K																
Total Memory:	8192 K																
Drive B : 1.2 M, 5.25 in.																	
Video : EGA/VGA																	
Halt On : All errors																	
ESC: Quit		↑ → ↓ ← : Select Item		PU/PD/+/-: Modify													
F1: Help		(Shift)F2: Change Color		F3: Toggle Calendar													

◆ Date

The date format is <month>, <day>, <year>. Press <F3> to show the calendar.

◆ Time

The time format is <hours>, <minutes>, <seconds>. The time is calculated based on the 24-hour military-time clock. For example 1 p.m. is 13:00:00.

Day	The day, from Sun to Sat, Determined by the BIOS date, month and year entries.
Date	The date, from 1 to 31 (or maximum allowed in a month)
Month	The month, Jan to Dec.
Year	The year, from 1900 to 2099



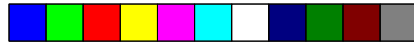

◆ **Primary/Secondary Drive type**

This category identifies the types of hard disk drives that have been installed in the computer. There are 46 predefined types and a user definable type.

Press PgUp or PgDn to select a numbered hard disk type or type a number and press <Enter>. Note that the specifications of your drive must match with the drive table. The hard disk will not work properly if you enter improper information for this category. If your hard disk type is not listed, you can Type User to define your own drive manually.

If you select Type User, you will be asked to enter the following info. Enter the paramters directly from the keyboard and press <Enter>. The hard disk information should be provided in the documentation from the hard disk vendor or the system manufacturer.

CYLS	number of cylinders
HEADS	number of heads
PRECOMP	written precom
LANDZONE	landing zone
SECTORS	number of sectors

If a hard disk has not been installed or you have a CD-ROM/Tape drive connected to an IDE channel, select NONE and press <Enter>.

◆ **Drive A type/Drive B type**

This category identifies the types of floppy disk drive A or B, that have been installed in your computer.

None	No floppy drive installed
360K, 5.25 in.	5-1/4 inch PC-type standard drive; 360 kilobyte capacity
1.2M,5.25 in.	5-1/4 inch AT-type high-density drive; 1.2 megabyte capacity
720K, 3.5 in.	3-1/2 inch double-sided drive; 720 kilobyte capacity
1.44M, 3.5 in.	3-1/2 inch double-sided drive; 1.44 megabyte capacity
2.88M, 3.5 in.	3-1/2 inch double-sided drive; 2.88 megabyte capacity



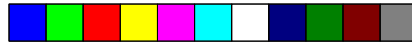

◆ **Video**

This category detects the type of graphics adapter used for the primary display system. It must match your video display card and monitor. Although secondary monitors are supported, you do not have to select that type in setup.

EGA/VGA	Enhanced Graphics Adapter/Video Graphics Array. For VGA,SVGA, or PGA monitor adapters.
CGA 40	Color Graphics Adapter, power up in 40 column mode.
CGA 80	Color Graphics Adapter, power up in 80 column mode.
Mono	Monochrome adapter, includes hi-res monochrome.

◆ **Halt On**

The category determines whether the computer will stop if an error is detected during power up.

No errors	Whenever the BIOS has detected a non-fatal error, the system will be stopped and you will be prompted.
All errors	The system boot will not be stopped for any errors that are detected.
All, but Keyboard	The system boot will not stop for a keyboard error;it will stop for all other errors.
All, but Diskette	The system boot will not stop for disk errors; it will stop for all other errors.
All, but Disk/Key	The system boot will not stop for a keyboard or disk error; it will stop for all other errors.

◆ **Memory**

The category is for display-only and it is determined by POST Power On Self Test of the BIOS.

Base Memory

The POST of the BIOS will determine the amount of base (or conventional) memory installed in the system. The value of the base memory is typically 640K.

Extended Memory

The BIOS determines how much extended memory is present during the POST. This is the amount of memory located above 1MB in the CPU's memory address map.



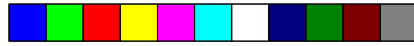

Expanded Memory

Expanded Memory (EMS) defines a 64Kb page frame in the area between 640K and 1Mb containing four 16K pages that are windows into the EMS memory. Programs issue requests to the EMS manager to switch the page to any part of EMS memory. Extended memory can be converted to emulate EMS by using a memory manager such as EMM386 that ships with Windows and DOS.

Other Memory

This refers to memory located in the 640K to 1024K address space. This memory can be used for different applications. DOS uses this area to load device drivers to keep as much conventional memory free for application programs as possible.

4.6. BIOS FEATURES SETUP



ROM ISA BIOS BIOS FEATURES SETUP AWARD SOFTWARE, INC.



Virus Warning	:Enabled	Video BIOS Shadow	:Enabled
CPU Internal Cache	:Enabled	C8000-CBFFF Shadow	:Disabled
External Cache	:Enabled	CC000-CFFFF Shadow	:Disabled
Boot Sequence	:A,C	D0000-D3FFF Shadow	:Disabled
Swap Floppy Drive	:Disabled	D4000-D7FFF Shadow	:Disabled
Boot Up Floppy Seek	:Enabled	D8000-DBFFF Shadow	:Disabled
Boot Up NumLock Status	:On	DC000-DFFFF Shadow	:Disabled
Memory Parity Check	:Enabled		
Gate A20 Option	:Fast		
Typematic Rate Setting	:Disabled		
Typematic Rate (Chars/sec)	:6		
Typematic Delay (msec)	:250		
Security Option	:Setup		
PS/2 Mouse Function	:Enabled		
PCI/VGA Palette Snooping	:Disabled		
OS select for DRAM >64MB:non-OS/2			
		ESC :Quit	↑ ↓ → ← :Select Item
		F1	:Help PU/PD/+/- :Modify
		F5	:Old Values (Shift)F2 :Color
		F6	:Load BIOS Defaults
		F7	:Load Setup Defaults



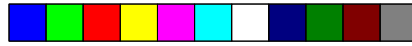

◆ **Virus warning**

This category flashes on screen. During and after the system boot up, any attempt to write to the boot sector or the partition table of the hard disk drive will halt the system and the following error message will appear. In the meantime, you can run an anti-virus program to locate the problem. Default value is Enabled.

Enabled	Activate automatically when the system boots up causing a warning message to appear when anything attempts to access the boot sector or hard disk partition table.
Disable	No warning message to appear when anything attempts to access the boot sector or hard disk partition table.

◆ **CPU Internal Cache/External Cache**

These two categories speed up the memory access. However, it depends on the CPU/Chipset design. Default value is Enabled.

Enabled	Enables the cache
Disabled	Disables the cache

◆ **Boot Sequence**

This category determines which drive the computer searches first for the disk operating system (i.e. DOS). Default value is A,C.

A,C	System will first search for floppy disk drive then hard disk drive.
C,A	System will first search for hard disk drive then floppy disk drive

◆ **Swap Floppy Drive**

Default value is Disabled

Enabled	Floppy A & B will be swapped under DOS
Disable	Floppy A & B will be normal definition.

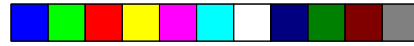

◆ **Boot Up Floppy Seek**

During POST, the BIOS will determine if the floppy disk drive installed is 40 or 80 tracks. 360K type is 40 tracks while 720K, 1.2M and 1.44M are all 80 tracks. Default value is Enabled

Enabled	BIOS searches for floppy disk drive to determine if it is 40 or 80 tracks. Note that the BIOS cannot tell from 720k, 1.2M or 1.44M drive type as they are all 80 tracks
Disabled	BIOS will not search for the type of floppy disk drive by track number. Note that there will not be any warning messages if the drive installed is 360K

◆ **Boot Up NumLock Status**

Default value is On

On	Keypad is number keys
Off	Keypad is arrow keys

◆ **Memory Parity Check**

The default value is disabled

◆ **Gate A20 Option**

Gate A20 controls the ability to access memory addresses above 1 MB by enabling (Fast) or disabling (Normal) access to the processor. Default value is Fast

◆ **Typematic Rate Setting, Typematic Rate (char/sec), and Typematic Delay.**

Typematic Rate Setting enables or disables the following two options. The Typematic Rate (6, 8, 10, 12, 15, 20, 24, or 30 characters per second) and Typematic Rate Delay (250, 500, 750, or 1000 milliseconds) control the speed at which the keystroke is repeated. The selected character is displayed when a key is held down after a delay set by the Typematic Rate Delay. It then repeats at a rate set by the Typematic Rate.

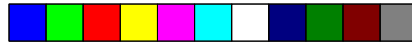

◆ Security Option

This category allows you to limit access to the system setup, or just setup. Default value is Setup

System	The system will not boot and access to Setup will be denied if the correct password is not entered at the prompt
Setup	The system will boot, but access to setup will be denied if the password is not entered at the prompt

◆ Video BIOS Shadow

It determines whether Video BIOS will be copied to RAM, however, it is an optional chipset design. Default is Enabled.

4.7 Chipset Features Setup

This screen controls the settings for the board's chip set. The controls for this screen are the same as the previous screen.

The Chipset Features Screen

ROM ISA BIOS
 CHIPSET SETUP UTILITY
 AWARD SOFTWARE, INC.

Auto Configuration	:Enabled	More Information on these settings can be found at Tyan's web site. http://www.tyan.com
DRAM Timing	:70ns	
DRAM RAS# Precharge Time	:3	ESC :Quit ↑ ↓ → ← :Select Item F1 :Help PU/PD/+/- :Modify F5 :Old Values (Shift)F2 :Color F6 :Load BIOS Defaults F7 :Load Setup Defaults
DRAM R/W Leadoff Timing	:6	
DRAM RAS to CAS Delay	:3	
DRAM Read Burst Timing	:x2222/x3333	
DRAM Write Burst Timing	:x2222	
Fast MA to RAS# Delay	:Disabled	
Fast EDO Path Select	:Disabled	
Refresh RAS# Assertion	:5/Clks	
ISA Bus Clk	:Clk/4	
SDRAM(CAS Lat/RAS to CAS	:Disabled	
System BIOS Cacheable	:Enabled	
Video BIOS Cacheable	:Enabled	
8 bit I/O Recovery Time	:1	
16 bit I/O Recovery Time	:1	
Memory Hole at 15M/16M	:Disabled	
Peer Concurrency	:Enable	

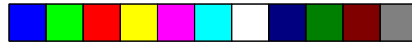

4.7.1 Power Management Setup

ROM ISA BIOS
POWER MANAGEMENT SETUP
AWARD SOFTWARE, INC

Power Management	:Disabled	IRQ3 (Com2)	:Off
PM Control By APM	:No	IRQ4 (Com1)	:Off
Video Off Method	:Blank Screen	IRQ5 (LPT2)	:Off
Doze Mode	:Disabled	IRQ6 (Floppy Disk)	:Off
Standby Mode	:Disabled	IRQ7 (LPT1)	:Off
Suspend Mode	:Disabled	IRQ8 (RTC Timer)	:Off
HDD Power Down	:Disabled	IRQ9 (IRQ2 Redir)	:Off
IRQ3 (Wake-Up Event)	:Off	IRQ10 (Reserved)	:Off
IRQ4 (Wake-Up Event)	:Off	IRQ11 (Reserved)	:Off
IRQ8 (Wake-Up Event)	:Off	IRQ12 (PS/2 Mouse)	:Off
IRQ12 (Wake-Up Event)	:Off	IRQ13 (Coprocesor)	:Off
		IRQ14 (Hard Disk)	:Off
		IRQ15 (Reserved)	:Off
<u>Power Down Activities</u>			
Com Ports Accessed	:Off		
LPT Ports Accessed	:Off		
Drive Ports Accessed	:Off		

◆ Power Management

Options are disabled, user defined, Min saving, and Max saving.

◆ PM Control by APM

Options are "Yes" and "No". When set for "No", system BIOS will ignore APM when power managing the system. If set on "Yes" the system BIOS will wait for APM's prompt before it enters any PM mode, e.g. Doze, Standby or Suspend.

◆ Video Off Method

The "Blank Screen" option will let the system BIOS blanks the screen when disabling video. V/H SYNC+Blank will let the BIOS turn off the V-SYNC and H-SYNC signals from the VGA card to the monitor.



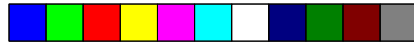

◆ **Doze Mode**

Defines the continuous idle time before the system enters Doze mode.

◆ **Standby Mode**

Defines the continuous idle time before the system enters Standby mode.

◆ **Power Down Activities**

Defines the activities that can cause the PM timers to reload. (Breaking out of PM Mode)



4.8 PCI Slot Configuration

ROM ISA BIOS
PCI SLOT CONFIGURATION
AWARD SOFTWARE, INC.

Resource Controlled by Reset Configuration	:Manual :Disabled	PCI IRQ Activated By: Level PCI IDE IRQ Map To: Auto Primary IDE INT#: A Secondary IDE INT#: B
IRQ3 assigned to	:legacy ISA	ESC: Quit ↑ ↓ → ← :Select Item F1 : Help PU/PD/+/- :Modify F5 : Old Values (Shift)F2 :Color F6 : Load BIOS Defaults F7 : Load Setup Defaults
IRQ4 assigned to	:legacy ISA	
IRQ5 assigned to	:PCI/PnP	
IRQ7 assigned to	:legacy ISA	
IRQ9 assigned to	:PCI/PnP	
IRQ10 assigned to	:PCI/PnP	
IRQ11 assigned to	:PCI/PnP	
IRQ12 assigned to	:PCI/PnP	
IRQ14 assigned to	:legacy ISA	
IRQ15 assigned to	:legacy ISA	
DMA0 assigned to	:PCI/PnP	
DMA1 assigned to	:PCI/PnP	
DMA3 assigned to	:PCI/PnP	
DMA5 assigned to	:PCI/PnP	
DMA6 assigned to	:PCI/PnP	
DMA7 assigned to	:PCI/PnP	

◆ PCI Slot 1/Slot 2/Slot 3/slot 4 INT#

◆ For Default Setting.

	Connect to PCI System INT#
PCI Slot1 INTA	INTA
PCI Slot1 INTB	INTB
PCI Slot1 INTC	INTC
PCI Slot1 INTD	INTD
PCI Slot2 INTA	INTB
PCI Slot2 INTB	INTC
PCI Slot2 INTC	INTD
PCI Slot2 INTD	INTA
PCI Slot3 INTA	INTC
PCI Slot3 INTB	INTD
PCI Slot3 INTC	INTA
PCI Slot3 INTD	INTB
PCI Slot4 INTA	INTD
PCI Slot4 INTB	INTA
PCI Slot4 INTC	INTB
PCI Slot4 INTD	INTC

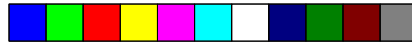

◆ **Resources Controlled By**

The Award Plug and Play BIOS can automatically configure all the boot and Plug and Play compatible devices. If you select Auto, all the interrupt request and DMA assignment fields disappear, as the BIOS automatically assigns them.

◆ **IRQ n assigned to**

When resources are controlled manually, assign each system interrupt as one of the following types, depending on the type of device using the interrupt.

Legacy ISA

Devices compliant with the original PC AT bus specification.

PCI/ISA PnP

Devices compliant with the Plug and Play standard, whether designed for the PCI or ISA bus architecture.

◆ **PCI IRQ Activated By:**

Select the PCI IRQ Active scheme either LEVEL or EDGE.

Default value is LEVEL.

◆ **PCI IDE IRQ Map To:**

Select the IDE IRQ Map to ISA IRQ#.

◆ **Primary IDE INT#**

Select the PCI INT# that the Primary IDE controller will use.

Default value is A.

◆ **Secondary IDE INT#**

Select the PCI INT# that the Secondary IDE controller will use.

Default value is B

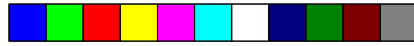

4.9 Integrated Peripherals

Integrated Peripherals Award Software, Inc.	
IDE HDD Block Mode	:Enabled
IDE Primary Master PIO	:Auto
IDE Primary Slave PIO	:Auto
IDE Secondary Master PIO	:Auto
IDE Secondary Slave PIO	:Auto
On-Chip Primary PCI-IDE	:Enable
On-Chip Secondary PCI-IDE	:Enable
PCI Slot IDE 2nd Channel	:Enable
On-Board FDC Controller	:Enable
On-Board Serial Port 1	:Com1/3F8
On-Board Serial Port 2	:Com2/2F8
On-Board Parallel Port	:378/IRQ7
Parallel Port Mode	:Normal

The Settings in the Integrated Peripherals lets the user enable or disable on-board device. You can also configure the I/O and IRQ settings of the on-board serial and parallel ports.

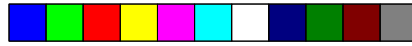

4.9. LOAD SETUP DEFAULTS

ROM ISA BIOS
CMOS SETUP UTILITY
AWARD SOFTWARE INC.

STANDARD CMOS SETUP	PASSWORD SETTING
BIOS FEATURES SETUP	IDE HDD AUTO DETECTION
CHIPSET F	SETUP
PCI SLOT	T SAVING
LOAD SETUP DEFAULTS	
<div style="border: 1px solid black; background-color: #e0e0e0; padding: 5px; display: inline-block;"> Load Setup Defaults (Y/N)? N </div>	
ESC : Save & Exit Setup F10 : Quit	
↑ ↓ → ← :Select Item (Shift)F2 :Change Color	
Load SETUP Defaults except standard CMOS SETUP	

◆ Load SETUP defaults

To load SETUP default values to CMOS SRAM, enter "Y". If not, enter "N"

◆ If any problem has occurred, loading the SETUP DEFAULTS is recommended.

4.10. PASSWORD SETTING

When you select this function, the following message will appear at the center of the screen to assist you in creating a password.

ENTER PASSWORD

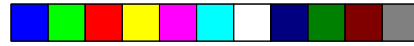

ROM ISA BIOS
 CMOS SETUP UTILITY
 AWARD SOFTWARE, INC.

STANDARD CMOS SETUP	PASSWORD SETTING
BIOS FEATURES SETUP	IDE HDD AUTO DETECTION
CHIPSET FE	SETUP
PCI SLOT C	UT SAVING
LOAD SETUP DEFAULTS	
<div style="border: 1px solid black; padding: 5px; display: inline-block;">Enter Password</div>	
ESC : Save & Exit Setup F10 : Quit	↑ ↓ → ← :Select Item (Shift)F2 :Change Color
Change/Set/Disable Password	

Type the password, up to eight characters, and press <Enter>. The password typed now will clear the previously entered password from CMOS memory. You will be asked to confirm the password. Type the password again and press <Enter>. You may also just press <Esc> to abort the selection and not enter a password.

To disable the password, just press <Enter> when you are prompted to enter a password. A message will confirm that the password has been disabled, the system will boot and you can enter Setup freely.

PASSWORD DISABLED

If you select System at Security Option of BIOS Features Setup Menu, you will be prompted for the password every time the system is rebooted or any time you try to enter setup. If you select Setup at Security Option of BIOS Features Setup Menu, you will be prompted only when you try to enter setup.



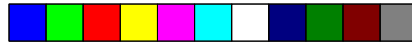

4.11. IDE HDD AUTO DETECTION

ROM ISA BIOS
CMOS SETUP UTILITY
AWARD SOFTWARE, INC.

		CYLS.	HEAD	PRECOMP	LANZONE	SECTORS
Drive C:	(202 Mb)	989	12	65535	989	35

Do you want to accept this as drive C (Y/N)?

Esc:Skip

Type "Y" to accept the H.D.D parameter reported by BIOS. Type "N" to keep the old H.D.D parameter info.

4.12. SAVE & EXIT SETUP

ROM ISA BIOS
CMOS SETUP UTILITY
AWARD SOFTWARE, INC.

STANDARD CMOS SETUP	PASSWORD SETTING
BIOS FEATURES SETUP	IDE HDD AUTO DETECTION
CHIPSET FIRMWARE SETUP	LOAD SETUP DEFAULTS
PCI SLOT CONFIGURATION	UT SAVING
Save to CMOS and EXIT (Y/N)? N	
ESC : Save & Exit Setup F10 : Quit	
↑ ↓ → ← :Select Item (Shift)F2 :Change Color	
Time, Date, Hard Disk Type,.....	

Type "Y" and you will quit the Setup Utility and save the user setup values to RTC CMOS SRAM. Type "N" to return to Setup Utility.

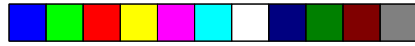

5.0 Flash Writer Utility

Warning: Do not flash the BIOS unless instructed by your dealer.

You can upgrade the BIOS of your mainboard by using a "Flash Memory Writer"(FMW) utility. This utility can be downloaded from Tyan's BBS(Consult your system vendor for the phone #) or web site. The system BIOS is stored on a 'flash' EPROM ROM chip on the mainboard which can be erased and reprogrammed by the FMW. The following three files make up the FMW.

AWDFLASH.EXE	-The Flash Memory Writer utility for Award to Award upgrade.
AMIFLASH.COM	-The Flash Memory Writer utility for AMI to AMI upgrade.
README	-A text file of instructions
*S70AWXX.BIN	-XX-A 2-digit version number.

Flash memory writer records (or 'programs') a new BIOS onto the flash memory chip. You cannot upgrade an Award BIOS to a AMI BIOS or a AMI BIOS to an Award BIOS.

*This file name is subject to change and can have either a "bin" or a "rom" extension.

Note

You should ALWAYS clear your CMOS after flashing a BIOS. This will clear out any stray settings from your old BIOS which may have been carried over from the flashing process. Most problems encountered after flashing a BIOS will be solved by this simple procedure.

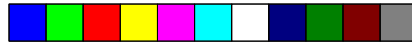

To reprogram the System BIOS, you must first do the following:

1. Check jumper J54.(Default pins 1-2)

The S1470 uses a 5V Flash EPROM so jumper J54 should be left in the default position on pins 1 and 2. This jumper should never be moved.

2. Make sure the CPU is running in 'real mode'.

FMW will not run if the CPU is operating in a protected or virtual mode. This means that you can not run it with Windows running or with any memory manager software. You must disable any memory manager first. The easiest way to do this is to:

- a. Boot your system from a bootable floppy disk with no CONFIG.SYS or AUTOEXEC.BAT files, and then run Flash Memory Writer from a backup copy of your support disk. You can make your back-up floppy bootable when you format it, and use one disk for both purposes.

- b. If you are using MS-DOS 6.x, you can use the feature that allows you to bypass the CONFIG.SYS and AUTOEXEC.BAT file. You do this while pressing <F5> while the "Starting MS-DOS..." line is on the screen.

There are other ways to accomplish the same result. The main point is to make sure no memory managers are running. If you are not sure, try running FMW. If it runs, then you have succeeded. If it displays a warning message about the CPU mode, you will have to try again.

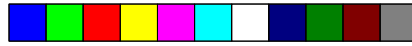

Once you have satisfied the two requirements mentioned above, you can run FMW. You can copy the contents of the “Flash” directory to your hard drive, or you can run the utility from a backup of the support floppy disk. Make sure the new BIOS file is in the same directory as the FMW utility.

To run FMW, change to the “Flash” directory if you are not already in it. Type “Awdflash” at the DOS command line and press the <Enter> key. The following screen will appear.

5.1 The Flash Memory Writer Utility Screen (Award)

FLASH MEMORY WRITER V3.0 Copyright (C) 1993, AWARD Software Inc.,	
For FX/HX-2A59CT51	Date:4/13/95
File Name to Program:	
Error Message:	

Type in the whole file name, e.g. A70AW10.BIN and confirm that you want to program the BIOS. The utility will then ‘Blank’, ‘Erase’, and then ‘Program’ the flash memory on the mainboard with the new BIOS file. You should choose “yes” to save the original system BIOS to a floppy diskette before you program the new BIOS. This leaves you with a backup of your original BIOS in case you need to re-install it. This option is highly recommended. If you can not successfully program the BIOS file for whatever reason, re-install you original BIOS from the backup file. Always reset the CMOS with jumper J43 after flashing to a new BIOS.

Warning: If you do not successfully install a complete BIOS file in the flash memory on the Mainboard, your system may not be able to boot. If this happens, it will require service by your system vendor. Follow the requirements and instructions in this section precisely to avoid inconvenience.



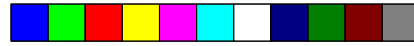

6.0 System Resource

6.1. TIMER & DMA CHANNEL MAP

TIMER MAP: TIMER Channel-0 system timer interrupt
 TIMER Channel-1 DRAM REFRESH request
 TIMER Channel-2 SPEAKER tone generator

DMA CHANNELS: DMA Channel-0 Available
 DMA Channel-1 Available
 DMA Channel-2 FLOPPY DISK adapter
 DMA Channel-3 Available
 DMA Channel-4 Cascade for DMA controller 1
 DMA Channel-5 Available
 DMA Channel-6 Available
 DMA Channel-7 Available

6.2 INTERRUPT MAP

NMI: Parity check error

IRQ (H/W) 0 System TIMER interrupt from TIMER-0
 1 KEYBOARD output buffer full
 2 Cascade for IRQ 9-15
 3 SERIAL port 2
 4 SERIAL port 1
 5 PARALLEL port 2
 6 FLOPPY DISK adapter
 7 PARALLEL port 1
 8 RTC clock
 9 Available
 10 Available
 11 Available
 12 PS/2 Mouse
 13 MATH co-processor
 14 Primary IDE
 15 Secondary IDE