

Notice for the USA

Compliance Information Statement (Declaration of Conformity Procedure) DoC

FCC Part 15: This Device complies with Part 15 of the FCC Rules.

Operation is subject to the following conditions:

1) this device may not cause harmful interference, and
2) this device must accept any interference received including interference that may cause undesired operation. If this equipment does cause harmful interference to radio or television reception, which can be determined by turning the equipment off and on, the user is encouraged to try one or more of the following measures:

- Reorient or relocate the receiving antenna.
- Increase the separation between the equipment and receiver.
- Plug the equipment into an outlet on a circuit different from that of the receiver.
- Consult the dealer or an experienced radio/television technician for help.

Notice for Canada

This apparatus complies with the Class B limits for radio interference as specified in the Canadian Department of Communications Radio Interference Regulations.

Cet appareil est conforme aux normes de Classe B d'interférence radio tel que spécifié par le Ministère Canadien des Communications dans les règlements d'interférence radio.

Notice for Europe (CE Mark)

This product is in conformity with the Council Directive 89/336/EEC, 92/31/EEC (EMC).

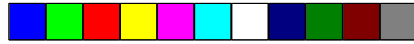

Table of Contents

1. Introduction.....	4
Overview.....	4
Icons.....	5
Hardware Specifications/Features.....	6
Software Specifications.....	9
Technical Support.....	9
Returning Merchandise for Service.....	10
2. Board Installation.....	12
Unpacking.....	12
Installation.....	13
Setting Jumpers.....	13
3. Onboard Resource Settings.....	14
Quick References for Jumpers.....	14
Map of Motherboard Jumpers.....	15
Soft Power Connector.....	19
Sleep Button Connector.....	19
Speaker Connector Installation.....	19
External SMI.....	19
Hardware Reset Switch Connector Installation.....	20
CMOS RTC.....	20
Flash EEPROM.....	21
Hardware CMOS & Password Reset.....	21
DRAM Installation.....	21
Installing the CPU.....	23
Peripheral Device Installation.....	28
Connecting the Power Supply.....	28
Frequently Asked Questions.....	30
4. BIOS Configuration.....	32
Standard Setup.....	32
BIOS Features Setup.....	34
Advanced Setup.....	35
Chipset Setup.....	40
Power Management Setup.....	49
PCI/PnP Setup.....	52
Peripheral Setup.....	55
Flash Writer Utility.....	58



5. System Resources.....	60
POST Checkpoint Codes.....	60
Beep Codes.....	68
Troubleshooting System Problems.....	69
Displayed Error Messages.....	70
Additional Manuals.....	72



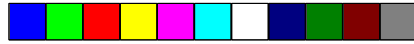

chapter 1

Introduction

Overview

The Thunder 2 (S1696DLUA) is a quality, high performance motherboard designed for Intel's latest generation of Pentium II microprocessors. This motherboard utilizes Intel's 440LX AGP series chipset (also called AGPset) and supports Pentium II CPU speeds of 233MHz to 300MHz.

The Thunder 2 mainboard with built-in AGP slot provides high performance capabilities that are ideal for a wide range of demanding applications such as CAD, CAM, CAE, desktop publishing, 3D animation, and video production. The Thunder 2 is suitable as a powerful workstation, internet, intranet, file, network, and database server. The Thunder 2's superior dual processor technology increases performance and productivity drastically for multi-processor enabled operating systems such as Microsoft Windows NT, Novell Netware SMP, and SCO Unix.

This integrated system board achieves high reliability with numerous features. Some of the features included are onboard dual channel PCI UltraDMA 33, built-in Adaptec AIC7895 two channel ultra-wide SCSI and a third narrow SCSI, built-in Yamaha 16-bit OPL3-SA3 and OPL4-

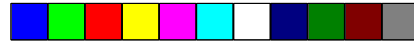

ML wavetable and 3D sound chips, onboard floppy controller, and onboard high speed I/O.

The Thunder 2 board is built to be both flexible and expandable. With I/O and drive controller support built onboard, the four 32-bit PCI BUS Master and two ISA slots (one shared, six usable) are available for add-on expansion cards.

Icons

In order to help you navigate this manual and set up your system, we have added several icons to our format.



This icon alerts you to particularly important details regarding the setup or maintenance of your system. This icon often appears next to information that may keep you from damaging your board or system. While we will often point out the most vital paragraphs in a chapter, you should always read every word in the text. Failing to do so can lead to exasperation and expense.



Wherever possible, we have included step-by-step instructions for setting up your system, which are indicated by this icon. However, it is in your best interest to read an entire section (and perhaps the entire manual) before you begin to alter the settings on your motherboard.



While we have alerted you to potential dangers in several places in this manual with this icon, these warnings should not be regarded as the whole of your safety regimen. Never forget that computers are electrical devices, and are capable of delivering a burn or shock. Prevent damage to yourself and to your board: always ensure that your system is turned off and unplugged whenever you are working with it, and that you are equipped with a static safety device.

Hardware Specifications/Features

Processor Information

- ♦Pentium II 233-300 MHz.
- ♦Two SEC slots (Slot One).
- ♦2 VRM components installed onboard.
- ♦3 onboard CPU fan connectors.
- ♦Intel MPS v1.4 compliant.

Chipset Information

- ♦Intel 440LX AGPset.
- ♦Intel 82371AB(PIIX4).
- ♦Intel 82093 I/O APIC chip.

Voltage and Power Information

- ♦ATX power supply connector.
- ♦+12 V power source for DC fan onboard.
- ♦3.3V DRAM support.
- ♦Utilizes GTL+ BUS, reducing power consumption and EMI.
- ♦Power recovery after interrupt.
- ♦Bulit-in overload protection that automatically shuts down the system in case of power surge.

Main Memory

- ♦Up to 1024MB EDO or 512MB SDRAM onboard.
- ♦Four 168-pin DIMM slots.
- ♦EDO or SDRAM support.
- ♦ECC support.

System Management

- ♦Wake-on LAN 3-pin connector for remote booting by Network Administrator.
- ♦Onboard National LM75 chip for CPU temperature sensing.

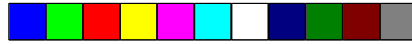

INTRO

- ♦ Onboard National LM78 thermal control chip for heat, fan, and voltage. Reports to the operating system for system monitoring. LANdesk compatible.
- ♦ Intel LANDesk Client Manager software, and/or Intel LANDesk Server Manager software (with LM78 installed).

Expansion Slots

- ♦ One AGP slot for 3D graphics card (supports 1x and 2x).
- ♦ Four 32-bit PCI BUS Master slots.
- ♦ Two 16-bit ISA slots.
- ♦ One shared, six usable.

Physical Dimensions

- ♦ Intel ATX design.
- ♦ 9.75 x 12 inches.
- ♦ Double-row ATX connectors.

BIOS Information

- ♦ AMI Plug and Play flash BIOS.
- ♦ Deep Green and Energy Star compliant.
- ♦ ACPI, Year 2000, and PC97/98 ready; PCI 2.1 compliant.
- ♦ Soft power-down, multiple boot options.
- ♦ Win98 Ready, DMI 2.0 compliant.
- ♦ Support for easy BIOS upgrades with flash EEPROM chip.

IDE Disk Drive & System I/O

- ♦ Two PCI BUS Mastering EIDE channels.
- ♦ Supports EIDE CD-ROMs.
- ♦ PIO Mode 3 & 4 (up to 17MB/sec DTR).

- ♦UltraDMA 33 BUS Mastering Mode (up to 33MB/sec DTR).
- ♦Two floppy drives (up to 2.88MB).
- ♦Two ATX serial ports (16550 UARTs).
- ♦One ATX ECP/EPP parallel port.
- ♦One IR (InfraRed) I/O interface port.
- ♦Two USB rev 1.2 (universal serial BUS) ports.
- ♦One ATX PS/2 mouse port.
- ♦One ATX PS/2 keyboard connector.

SCSI Disk Controller

- ♦Onboard two channel Adaptec AIC-7895 Ultra-Wide SCSI controller (equivalent to Adaptec 3940AUW).
- ♦Two Ultra-Wide channels with synchronous 40MB/s DTR. Connect up to fifteen 16-bit devices per channel (thirty devices total). Up to seven of the fifteen devices can be 8-bit devices.
- ♦One Narrow channel with 20MB/s DTR.
- ♦Built-in RISC sequencer automates SCSI protocol. Supports 32-bit BUS master DMA transfer.
- ♦RAID 0, 1, and 5 function built-in with optional RAIDport card installed.

Sound Chip Information

- ♦Onboard Yamaha OPL3-SA3 advanced 16-bit FM-synthesizer.
- ♦Onboard Yamaha OPL4-ML advanced wavetable with General MIDI and MPU401 support.
- ♦44 voice wavetable synthesis in 1MB of wavetable ROM.

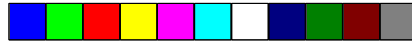

TYAN
COMPUTER

INTRO

- ♦Sound Blaster Pro and Windows Sound System compatible.
- ♦Plug and Play with full duplex operation.
- ♦Built-in 3D stereo sound and power management.
- ♦One game joystick port, one line-input, speaker output, and one microphone input.

Software Specifications

Operating System

- ♦Operates with MS-DOS, Windows 3.x, Windows for WorkGroups 3.x, Windows 95, Windows NT, OS/2, Novell Netware, Solaris, and SCO Unix.

Technical Support

If a problem arises with your system, you should first turn to your dealer for help. Your system has most likely been configured by them, and they should have the best idea of what hardware and software your system contains. Hence, they should be able to be of the most assistance. Further, if you purchased your system from a dealer near to you, you can actually bring your system in to them to have it serviced, instead of attempting to yourself (which can have expensive consequences).

If your dealer is unable to assist you:

Try our web page – [http:// www.tyan.com](http://www.tyan.com),

or user newsgroup – alt.comp.periphs.mainboard.tyan.

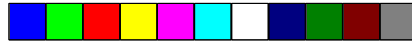

Returning Merchandise for Service

During the warranty period, contact your distributor or system vendor **FIRST** for any product problems. This warranty only covers normal customer use and does not cover damages incurred during shipping or failure due to the alteration, misuse, abuse, or improper maintenance of products.

For Resellers Only:

A receipt or copy of your invoice marked with the date of purchase is required before any warranty service can be rendered. You can obtain service by calling the manufacturer for a Return Merchandise Authorization (RMA) number. The RMA number should be prominently displayed on the outside of the shipping carton and the package should be mailed prepaid, or hand-carried to the manufacturer. Shipping and handling charges will be applied for all orders that must be mailed when service is complete.

Trademarks

AMI BIOS/Flash are trademarks of American Megatrend Inc.

Windows is a trademark of Microsoft Corporation.

IBM, PC, AT, PS/2 are trademarks of IBM Corporation.

INTEL, Pentium II are trademarks of Intel Corporation.

S1696DLUA Thunder 2 is a trademark of TYAN Computer Corporation.

All other trademarks are the property of their respective companies.

Disclaimer

Information presented in this publication has been carefully checked for reliability. However, no responsibility is assumed for inaccuracies. The information contained in this document is subject to change without notice.

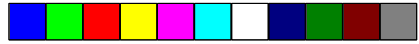

TYAN
COMPUTER

INTRO



This page has been left blank intentionally.



chapter 2

Board Installation

Unpacking

The mainboard package should contain the following:

- S1696DLUA mainboard
- One IDE 40-pin cable
- One 34-pin floppy cable
- One 50-pin narrow SCSI cable
- One 68-pin wide SCSI cable
- One Thunder 2 user's manual
- One SCSI and sound appendix package (appendices A, B, and C)
- Two retention modules

The mainboard contains sensitive electric components which can be easily damaged by static electricity, so the mainboard should be left in its original packaging until it is ready to be installed.



With the power supply plugged in and turned off, touch an unpainted area of the system chassis immediately before handling the mainboard or any component. Doing so discharges any static charge your body may have acquired.



After opening the mainboard carton, extract the system board—holding it by its edges—and place it on a grounded anti-static surface, component side up. Inspect the board for damage. Press down on any of the socket ICs if it appears that they are not properly seated (the board should still be on an anti-static mat). Do not touch the bottom of the board.



DO NOT APPLY POWER TO THE BOARD IF IT HAS BEEN DAMAGED!

INSTALL

Installation

You are now ready to install your mainboard. The mounting hole pattern of the S1696DLUA matches the ATX system board specifications. Your chassis should be that of a standard ATX mainboard form factor.



Setting Jumpers



In this manual, the terms “closed” and “on” are used when referring to jumpers (or jumper pins) that are active; “open” and “off” are used when referring to jumpers (or jumper pins) that are not connected. Jumpers and pins are connected by slipping the black plastic jumper connector overtop of two adjacent jumper pins. The metal rod inside the plastic shell bridges the gap between the two pins, completing the circuit. See the pictures below for examples of “on” and “off” pins and jumpers.

2 pin jumpers

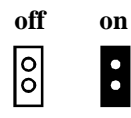

3 (or more) pin jumpers

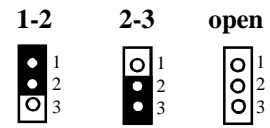

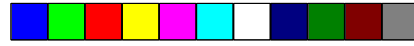

chapter 3

Onboard Resource Settings

Quick References for Jumpers

The following tables will help you set the jumpers for CPU speed, memory voltage settings, and SCSI PCI-ID, among others. The miniature motherboard maps will help you locate the jumpers on your board. A full-page map of the motherboard can be found on page 15.



Map of Motherboard Jumpers

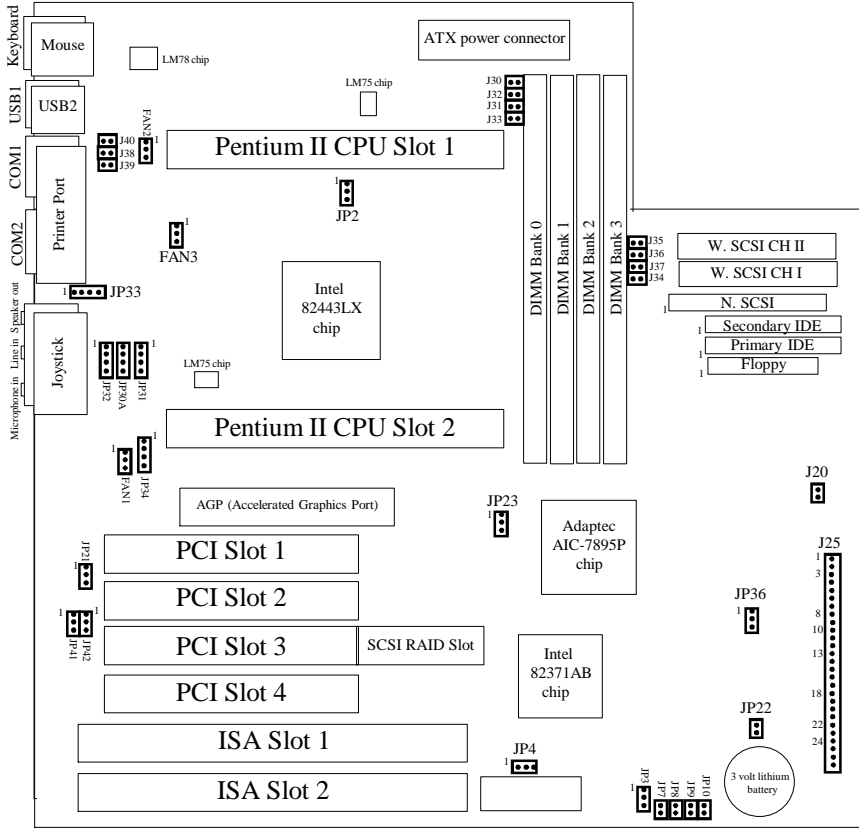

The tiny “1”s next to jumpers of 3 pins or more indicate the position of pin 1 for that jumper. Refer to pages 16-18 for jumper and pin assignments.

TYAN Chapter 3
COMPUTER

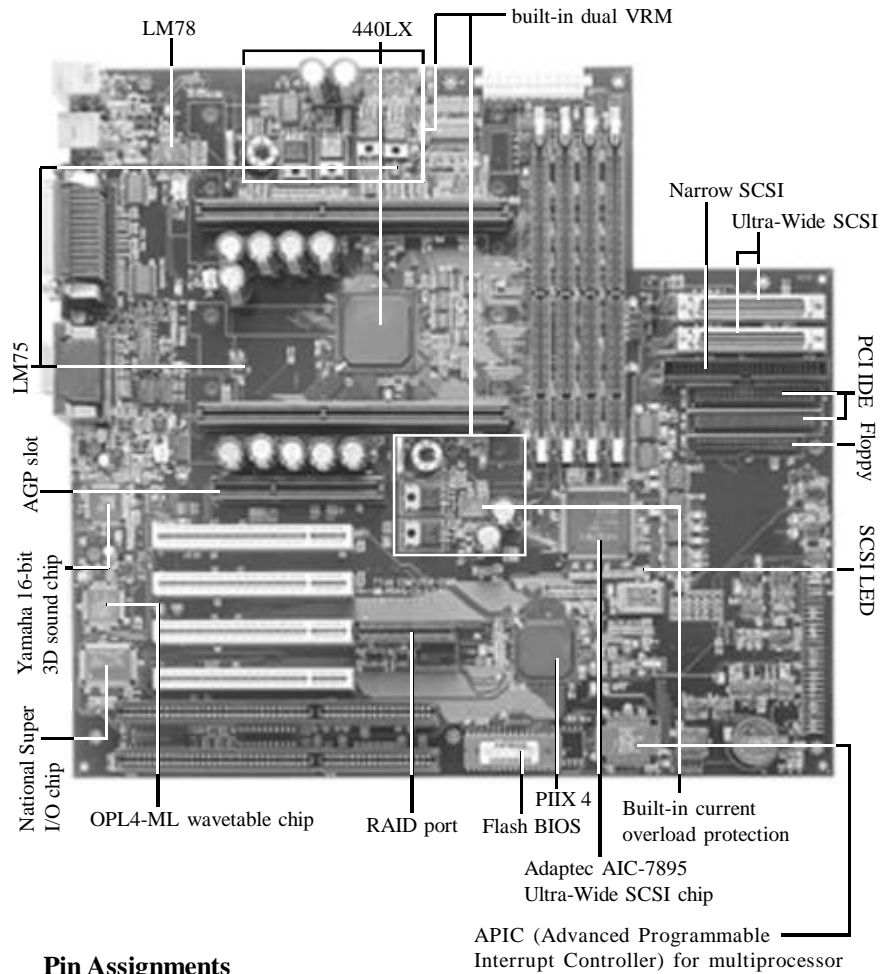

Pin Assignments

	1	2	3
JP21 (Wake-on LAN)	Standby 5V	GND	Wake (Power-on Active High)
FAN1-FAN3	GND	VCC	Fan Monitor

(-- indicates pin is absent)

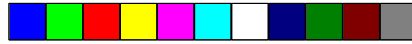

Jumper Settings by CPU Type

CPU	JP7	JP8	JP9	JP10
Pentium II 200MHz	ON	ON	OFF	ON
Pentium II 233MHz	ON	OFF	OFF	ON
Pentium II 266MHz	ON	ON	ON	OFF
Pentium II 300MHz	ON	OFF	ON	OFF
*Pentium II 333MHz	ON	ON	OFF	OFF

*Due to this CPU's unavailability, this speed has not been tested.

DIMM Voltage Settings

DIMM VCC	J30	J31	J32	J33	J34	J35	J36	J37
3.3V (default)	ON	ON	ON	ON	OFF	OFF	OFF	OFF
5V	OFF	OFF	OFF	OFF	ON	ON	ON	ON

ONBOARD

Real Time Clock

RTC	JP3
Default	1-2
RESET CMOS	2-3

The speed of your CPU is printed on the edge of the processor. It is a three digit number after "PX". The processor shown below is 233MHz.



PCI-ID for SCSI Chip

PCI ID for SCSI	JP23
AD_26 (default)	1-2
AD_24	2-3

SCSI External HDD LED

EXT-HDD LED	JP22
Active Low--Connect to Front Panel HDD LED	pin 1
Not Connected	pin 2

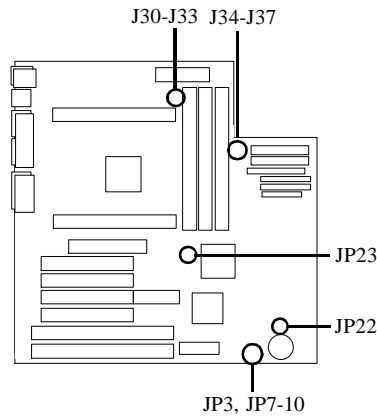

Reserved

Reserved	
JP2	OPEN
JP38	Hardwired ON
JP39	Hardwired ON
JP40	OFF
JP48	OPEN

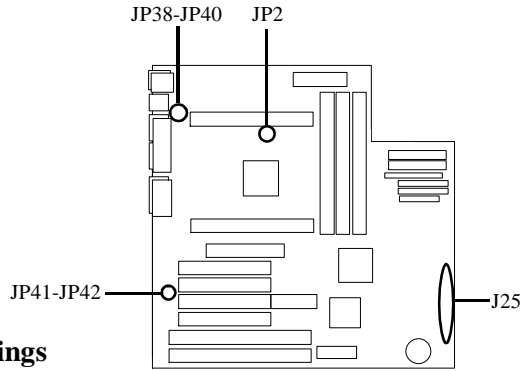

COM2/InfraRed Settings

	COM2	IR
JP41	1-2	2-3
JP42	1-2	2-3
JP45	ON	OFF
JP46	OFF	ON

SCSI Termination Settings

	Pins	Assignment
CH. A		
JP43	1-2	SCSI high byte termination: all on (default)
	2-3	Termination control by SCSI chip
CH. B		
JP44	1-2	SCSI high byte termination: all on (default)
	2-3	Termination control by SCSI chip

CMOS Voltage Settings

	JP4
5V (default)	1-2
12V	2-3

J25 Settings

Pins	1-2	3-4	6-11	13-16	18-20	22-23	24-27
Function	Power On/Off	Sleep	IR Connector	HDD LED	Power LED	Reset	Speaker
Assignment	1=Power On/Off 2=GND	3=GND 4=Sleep	6=VCC 7=NC 8=IR RX 9=GND 10=IR TX 11=Mode	13=VCC 14=NC 15=- 16=+	18=GND 19=NC 20=+	22=GND 23=Reset	24=VCC 25=NC 26=INT-SPK 27=-



Soft Power Connector

The Soft Power Connector is located on pins 1 and 2 of jumper block J25. Pressing the Soft Power Button will turn the system on (and off).

Sleep Button Connector

The sleep button connector is located on pin 3 and pin 4 of jumper block J25. Pressing this button will put the system in Sleep or Suspend mode. Pressing it once more will wake up the system. The power LED will blink when the system is in Sleep mode.

A four second override feature is built into the motherboard according to PC98 specifications. If you hold the sleep button for more than four seconds, the system will shut itself down. Use the four second override feature when the system hangs or crashes. This feature is not intended for normal shutdown operation. Please use the regular soft power button for a normal shutdown.

ONBOARD

Speaker Connector Installation

The S1696DLUA provides a 4-pin header to connect the speaker. The speaker is connected to pins 24-27 of jumper block J25.

External SMI

The external SMI is located at jumper JP47. The pin assignment is pin1: external SMI; pin 2: GND.

Hardware Reset Switch Connector Installation

The Reset switch on your case's display panel provides you with the Hardware Reset function, which is the same as power on/off. The system will do a cold start after the Reset button is pushed. The Reset switch is a 2-pin connector and should be installed on pins 22 and 23 of jumper block J25.



Windows 95 Users:

You may encounter problems with some of the devices in the Intel 82371AB chipset. Neither the PCI Bridge nor the PCI Universal Serial BUS device IDs for this chipset (also called PIIX4) are recognized by Windows 95. This is a software problem, not a hardware problem, and can be easily remedied by either upgrading to Windows 98 or downloading the 82371AB patch found at <http://www.tyan.com> or at <ftp://download.intel.com/design/pcisets/busmastr/setupex.exe>. (Note: USB requires Windows 95 OSR 2.1 or above; please contact Microsoft for the USB update.)

CMOS RTC

The 440LX AGPset includes an internal battery and Real Time Clock circuit. The RTC provides the date and time for the system. If the battery is low, it will prevent your system from POSTing, and you will not get a display. Normally the life span of an RTC internal battery is 10 years, but if yours is running low, you will need to replace it with a new 3V lithium battery (Duracell DL2032).

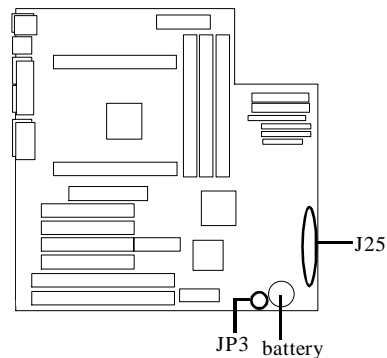

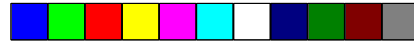

Flash EEPROM

The S1696DLUA uses flash memory to store BIOS programs. It can be updated as new versions of the BIOS become available. You can upgrade your BIOS easily using the flash utility (see page 58).

JP4 determines which type of EPROM is used. This jumper has been set to match the onboard BIOS chip. The factory default for the S1696DLUA is on pins 1-2. Depending on the type of EPROM used, some boards will have JP4 on pins 2-3.

Hardware CMOS & Password Reset



If you have been locked out of your system because you forgot your password or set the CMOS incorrectly, follow the instructions below.

1. Power off the system
2. Set jumper JP3 to pins 2 and 3 (see previous page for location of JP3).
3. Wait for 2 seconds, then return jumper JP3 to pins 1 and 2.
4. Power on the system again.

By following this procedure, you will erase your password and reset the CMOS to the BIOS defaults.

DRAM Installation

The S1696DLUA uses a 64-bit data path from memory to CPU and can accommodate up to 1024MB of EDO RAM and 512MB of SDRAM. SDRAMs (Synchronous DRAMs) are supported in the DIMM slots. DIMMs must be of the **unbuffered** variety. The position of the notch in the DRAM Key Position will tell you whether or not a DIMM is unbuffered (see figure on the next page). All installed memory will be automatically detected, so there is no need to set jumpers. The 440LX AGPset can cache up to 512MB of RAM.

ONBOARD

TYAN Chapter 3
COMPUTER

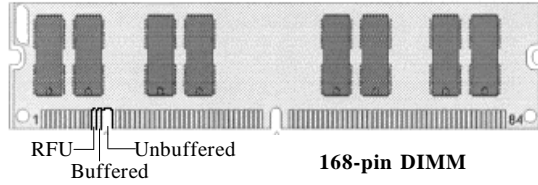

Some details of memory installation:

- ♦ One unbuffered DIMM must be installed for the system to POST.
- ♦ The mainboard supports 8MB, 16MB, 32MB, 64MB, 128MB (SDRAM), and 256MB (EDO only) DIMM modules.

The table below shows some of the possible memory configurations.

DIMM Bank 0	DIMM Bank 1	DIMM Bank 2	DIMM Bank 3	Total
16MBx1	0	0	0	16MB
16MBx1	16MBx1	0	0	32MB
32MBx1	0	0	0	32MB
16MBx1	16MBx1	16MBx1	0	48MB
32MBx1	32MBx1	0	0	64MB
64MBx1	0	0	0	64MB
32MBx1	32MBx1	32MBx1	0	96MB
16MBx1	16MBx1	32MBx1	32MBx1	96MB
32MBx1	32MBx1	32MBx1	32MBx1	128MB
64MBx1	64MBx1	0	0	128MB
64MBx1	64MBx1	64MB	64MBx1	256MB
128MBx1	128MBx1	128MBx1	128MBx1	*512MB
256MBx1	256MBx1MBx1	256MBx1	256MBx1	^1024MB

* Maximum for SDRAM.

^Maximum for EDO.

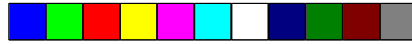

Installing the CPU

Pentium II processors (233 through 300MHz) can be used on the S1696DLUA. Please refer to page 15 for the correct CPU jumper settings for your board. Although the S1696DLUA motherboard is designed as a dual CPU system, it will also function with a single CPU.

The S1696DLUA board provides two slots for Pentium II processors, called the Pentium II primary and secondary slots. If only one CPU is used, that CPU should be plugged into the primary slot. When two CPUs are used, they should be of the same speed and type.

Remember:



- ♦ The CPU is a sensitive electronic component and it can easily be damaged by static electricity. Do not touch the CPU pins with your fingers.
- ♦ When installing the CPU into the socket, match the CPU pins to the socket pins. Note that one corner of the socket's top is different from the other three corners. Likewise, one corner of the CPU's bottom is different from the other three corners. Line the unique socket corner up with the unique CPU corner.
- ♦ Before the CPU is installed, the mainboard must be placed on a flat surface. You should be able to insert the CPU with minimal, but firm, pressure. Do not press down hard on the CPU.

ONBOARD

Active and Passive Processors

Currently, Intel produces two types of Pentium II processors: the active (or boxed) processor and the passive processor (refer to the pictures on the following page). These two types of processors are essentially the same in design; the only difference lies in their cooling methods. The active processor is equipped with a cooling fan and heat sink, while the passive processor is equipped with a heat sink alone. Both types of CPUs provide the user with the same performance, and both types can be installed in the Pentium II slots on the S1696DLUA board. Refer to page 24 for instructions regarding the installation and removal of Pentium II processors.



Pentium II Active (Boxed) CPU
Shown with Power Connector for Fan



Pentium II Passive CPU
Shown with Heat-sink

Installation of Pentium II Active (Boxed) Processors

Active processors are equipped with cooling fans. When installing an active CPU, you also need to connect the cooling fan cable to its connector.

Installing CPU Retention Modules

1. Installation of a Pentium II active processor requires a CPU retention module, which is first secured onto the motherboard. (Refer to the motherboard layout on Page 16.)
2. To attach the retention module, place the motherboard on a flat surface.
3. Locate the key pin on one end of the Pentium II slot on the board. Then carefully line up the key notch on the retention module with the key pin on the Pentium II slot (the key pin on the Pentium II slot indicates the correct orientation of the CPU).

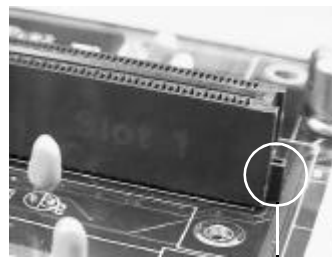

Pentium II Slot Connector and Key Pin

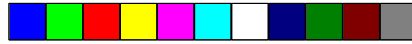

4. Drop the retention module down over the Pentium II slot so that the retention module sits flat against the motherboard. Tighten the screws in a clockwise manner to secure the module to the board. Warning: Do not over-tighten the screws as you may damage the module and/or the motherboard.



Retention Module

Installing the Active Processor



Pentium II CPU entering retention module

1. When the retention module is securely installed, you are ready to plug the CPU into the retention module.
2. Press firmly on the CPU until you hear a “click.” This clicking sound indicates that the CPU is fully locked into the retention module.
3. After the CPU is securely seated on the retention module in the Pentium II slot, connect the CPU’s cooling fan cable to the cooling fan power connector on the board.

ONBOARD

Installing CPU Cooling Fans



1. Locate the cooling fan connectors (3 connectors: FAN1-FAN3) on the motherboard.
2. Plug the CPU’s cooling fan cable into the cooling fan connector on the board. Make sure that the black wire of the cable is plugged into pin 1 of the connector. Refer to pin 1 marked on the layout on page 16. Pin assignments: pin 1–ground (black), pin 2–12 V (red), pin 3– signal (yellow).

Installation of Pentium II Passive Processors

Unlike active processors, passive processors are not equipped with cooling fans. Instead, they are equipped with heat sinks.

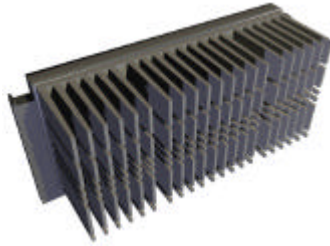

**Pentium II Passive
CPU Module**

Each CPU package should contain the following:

- One CPU retention module
- One heat sink retention bracket with mounting locks
- Two mounting attach-mounts
- One heat sink lock

Installing CPU Retention Modules

1. When installing the CPU retention module, make sure that you have the appropriate end of the module lined up with the key notch on the Pentium II slot connector. This will ensure that the module is installed properly.
2. Before tightening the screws, make certain that the module is flush against the motherboard. If one end of the module is raised above the board, check the orientation of the module.
3. Install the module on the board by turning the screws in a clockwise direction. Do not over-tighten the screws.

Installing Heat Sink Mounting Brackets

1. The heat sink mount has two pins on the bottom and four pins on the top. Notice that the bottom two pins are of different sizes. The size of the pins and the holes in the motherboard will determine the correct orientation. A correctly



**Heat Sink Mounting
Bracket**

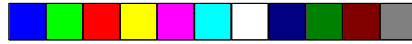

installed bracket can be verified by making sure that the four pins on the top are closest to the Pentium II CPU slot.



Mounting Locks

2. Insert the heat sink mount into the holes on the motherboard. When the bracket is properly inserted into the holes on the motherboard, you will hear a clicking noise.

3. Lock the heat sink mount to the board by inserting the two mounting locks into the pins of the heat sink mounting bracket which are now below the mainboard. There will be a click when the locks are securely fastened.

Installing the Passive Processor



1. Align the CPU with the CPU retention module. Make sure the heat sink is lined up with the heat sink mount bracket. If you put the CPU in the wrong way, you may damage the CPU, the motherboard, and/or the CPU socket.

2. Slowly press down on the CPU module until the CPU locks into place. A clicking noise will be heard when the CPU is locked securely into the module.

Installing Heat Sink Locks

The heat sink lock has four notches which will correspond to the four pins on the heat sink mounting bracket. Gently slide the lock between the heat sink onto the heat sink mounting bracket until both sides of the lock are firmly secured. A clicking sound will be heard when the lock is securely fastened to the heat sink mounting bracket. To remove the lock from the heat sink mounting bracket, gently press the ends of the locks inward and pull.



Heat Sink Lock

ONBOARD



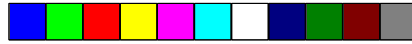

TYAN Chapter 3 COMPUTER

Removing Pentium II Passive Processors and CPU Retention Modules

To remove the CPU, move the locks to the center of the CPU. A click will be heard when the CPU has been unlocked. Gently pull up on the CPU, taking care not to bend the motherboard or the CPU retention module.

Removing Heat Sink Locks

To remove the lock from the retention bracket, gently press the ends of the locks inward and pull.

Peripheral Device Installation

After all the jumpers on the mainboard have been set, the mainboard can be mounted into the case. You may then install the display card and any other peripheral devices that you may have.

If a PCI-BUS interface card is to be installed in the system, any one of the four PCI-BUS slots can support either a Master or a Slave device.

After installing the peripheral controllers, you should check the CPU and all of your devices again before preparing to power on the system.

Connecting the Power Supply



The female power supply connector on the mainboard fits with the male power supply connector from a 3.3V, 5V, or 12V power supply. Beware: incorrect installation of the power supply can result in serious damage to the system board and connected peripherals. Before connecting the leads from the power supply, you should first make sure that the power supply is unplugged.





Most male power supply connectors will have twenty wires, seven of which are black. The black wires will be in the middle of the connector. The easiest way to orient the connectors properly is to line up the plastic clip on the male connector with the tab on the female connector. The plastic clip should be facing the edge of the motherboard.

 Align the plastic guide pins on the male connector with their receptacles on the mainboard. You may need to hold the lead at an angle in order to properly line it up with the onboard connector. Once you have the guide pins aligned, press the lead into the connector so that the plastic clip on the lead snaps into place and secures the lead to the connector. Please see the figure below.

ONBOARD



Power supply connector

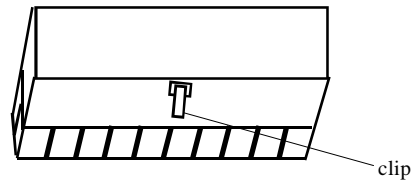

Onboard connector

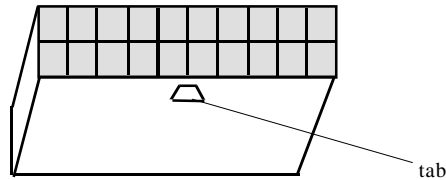

Frequently Asked Questions

Q: Why don't I get a display after I put in my old DIMM module?

A: The 440LX chipset requires the memory manufacturer to program an EEPROM chip with **SPD** (Serial Presence Detection) on the module in order for the BIOS to program the 440LX's timing registers properly. Your DIMM may not have the EEPROM chip on the module, or the EEPROM may not contain the correct program. Check with your memory vendor for details. The figure below shows a DIMM module with an EEPROM chip.

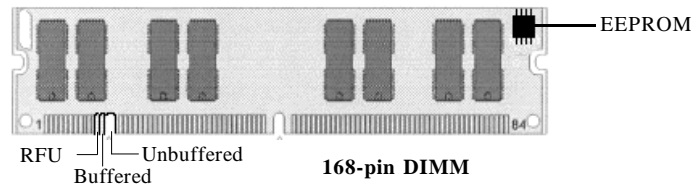

Q: My system sometimes becomes unstable. How should I check the system?

A: The first thing to do is to check and see if you have any device conflict in address, IRQ, or DMA. If you are using Windows 95, the Device Manager is a good place to start. Please consult your operating system manual for detail. Second of all, slowing down the memory timing in the BIOS's chipset setup section will help the situation, as well. Many memory modules are not suitable for high performance systems and are probably the main source of your problem.

Q: I've installed Windows NT with one CPU and with the multiprocessor kernel. However, when I add a second CPU later, only one CPU is detected during the Windows NT boot up.

A: AMI BIOS only builds multiprocessor tables according to the number of CPUs present during Windows NT installation. Therefore, you must either reinstall NT with two CPUs or use the Windows NT resources kit to change from a uniprocessor to a multiprocessor system.

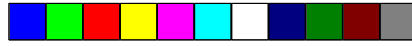

TYAN
COMPUTER

Q: How do I know if the system detects the number of CPUs properly?

A: The AMI BIOS will show a “Pentium–II x2” message during the memory check to indicate the presence of two CPUs.

Q: How many devices can I hook up to each SCSI channel?

A: You can cascade up to fifteen 16-bit devices per channel and seven of them can be 8-bit devices.

Q: How do I use the RAID port on my motherboard?

A: The RAID port allows you to put in an Adaptec Array 1000 family card, which will enable the SCSI chip on the motherboard to perform the RAID function under Netware and Windows NT. RAID 0 is used for performance purposes (increases SCSI speed), RAID 1 is used for mirroring (creates two drives with identical information), and RAID 5 is used for redundancy (if one drive goes down, another will take its place).

Q: Can I mix EDO DIMM with SDRAM DIMM on this motherboard?

A: Yes. However, the AGP graphics card performs better with SDRAM installed on the motherboard because the AGP card can store the texture map in the system memory.

Q: What is AGP (Accelerated Graphics Port)?

A: AGP (Accelerated Graphics Port) is a new BUS architecture for 3D graphics. The AGP slot eliminates the PCI bandwidth bottleneck by bypassing the PCI interface and accessing the system memory directly. Currently, the AGP supports 1X and 2X which yields bandwidths of 264MB/s at 33MHz and 533MB/s at 66MHz BUS speeds, respectively. Compare with 132MB/s at 33MHz bus speed with PCI bus.

Q: Does my operating system support AGP?

A: Currently, only Windows 98 and Windows NT 5.0 will have built-in support for AGP. Some AGP cards require Windows 95 OSR2.1 or a special driver from Intel. Please check with your graphics vendor for more detail.

ONBOARD

chapter 4

BIOS Configuration

Standard Setup

Select the AMIBIOS Setup options below by choosing Standard Setup from the AMIBIOS Setup main menu. Standard Setup options are described below.

Floppy Drive A: and B:

Move the cursor to these fields via the arrow keys and select the floppy type. The settings are 360KB 5¼ inch, 1.2 MB 5¼ inch, 720KB 3½ inch, 1.44MB 3½ inch, or 2.88MB 3½ inch.

Primary Master, Primary Slave, Secondary Master, Secondary Slave

Select these options to configure the drive named in the option. Select Auto Detect IDE to let AMIBIOS automatically configure the drive. A screen with a list of drive parameters appears. Click on OK to configure the drive.

Type	How to Configure
SCSI	Select <i>Type</i> . Select <i>Not Installed</i> on the drive parameter screen. The SCSI drivers provided by the SCSI manufacturer should allow you to configure the SCSI drive.
IDE	Select <i>Type</i> . Select <i>Auto</i> to let AMIBIOS determine the parameters. Click on <i>OK</i> when AMIBIOS displays the drive parameters. Select <i>LBA Mode</i> . Select <i>On</i> if the drive has a capacity greater than 540MB. Select <i>Block Mode</i> . Select <i>On</i> to allow block mode data transfers. Select <i>32-Bit Mode</i> . Select <i>On</i> to allow 32-bit data transfers. Select the <i>PIO Mode</i> . It is best to select <i>Auto</i> to allow AMIBIOS to determine the PIO mode. If you select a PIO mode that is not supported by the IDE drive, the drive will not work properly. If you are absolutely certain that you know the drive's PIO mode, select PIO mode 0-4, as appropriate.
CD-ROM	Select <i>Type</i> . Select <i>CDROM</i> . Click on <i>OK</i> when AMIBIOS displays the drive parameters.
Standard MFM	Select <i>Type</i> . You must know the drive parameters. Select the drive type that exactly matches your drive's parameters.
Non-Standard MFM	Select <i>Type</i> . If the drive parameters do not match the drive parameters listed for drive types 1-46, select <i>User</i> and enter the correct hard disk drive parameters.

Entering Drive Parameters

You can also enter the hard disk drive parameters yourself. The drive parameters are as follows:

Parameter	Description
Type	The number for a drive with certain identification parameters.
Cylinders	The number of cylinders in the disk drive.
Heads	The number of heads.
Write Precompensation	The actual physical size of a sector gets progressively smaller as the track diameter diminishes. Yet each sector must still hold 512 bytes. Write precompensation circuitry on the hard disk compensates for the physical difference in sector size by boosting the write current for sectors on inner tracks. This parameter is the track number on the disk surface where write precompensation begins.
Landing Zone	This number is the cylinder location where the heads normally park when the system is shut down.
Sectors	The number of sectors per track. MFM drives have 17 sectors per track. RLL drives have 26 sectors per track. ESDI drives have 34 sectors per track. SCSI and IDE drives have even more sectors per track.
Capacity	The formatted capacity of the drive is the number of heads times the number of cylinders times the number of sectors per track times 512 (bytes per sector).

TYAN Chapter 4
COMPUTER

Type	Cylinders	Heads	Write Precompensation	Landing Zone	Sectors	Capacity
1	306	4	128	305	17	10 MB
2	615	4	300	615	17	20 MB
3	615	6	300	615	17	31 MB
4	940	8	512	940	17	62 MB
5	940	6	512	940	17	47 MB
6	615	4	65535	615	17	20 MB
7	462	8	256	511	17	31 MB
8	733	5	65535	733	17	30 MB
9	900	15	65535	901	17	112 MB
10	820	3	65535	820	17	20 MB
11	855	5	65535	855	17	35 MB
12	855	7	65535	855	17	50 MB
13	306	8	128	319	17	20 MB
14	733	7	65535	733	17	43 MB
16	612	4	0	663	17	20 MB
17	977	5	300	977	17	41 MB
18	977	7	65535	977	17	57 MB
19	1024	7	512	1023	17	60 MB
20	733	5	300	732	17	30 MB
21	733	7	300	732	17	43 MB
22	733	5	300	733	17	30 MB
23	306	4	0	336	17	10 MB
24	925	7	0	925	17	54 MB
25	925	9	65535	925	17	69 MB
26	754	7	754	754	17	44 MB
27	754	11	65535	754	17	69 MB
28	699	7	256	699	17	41 MB
29	823	10	65535	823	17	68 MB
30	918	7	918	918	17	53 MB
31	1024	11	65535	1024	17	94 MB
32	1024	15	65535	1024	17	128 MB
33	1024	5	1024	1024	17	43 MB
34	612	2	128	612	17	10 MB
35	1024	9	65535	1024	17	77 MB
36	1024	8	512	1024	17	68 MB
37	615	8	128	615	17	41 MB
38	987	3	987	987	17	25 MB
39	987	7	987	987	17	57 MB
40	820	6	820	820	17	41 MB
41	977	5	977	977	17	41 MB
511	981	5	981	981	17	41 MB
43	830	7	512	830	17	48 MB
44	830	10	65535	830	17	69 MB
45	917	15	65535	918	17	114 MB
46	1224	15	65535	1223	17	152 MB

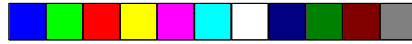

Advanced Setup

The Advanced Setup options included in the AMIBIOS Setup generated through AMIBCP and the AMIBIOS for the Intel 440LX chipset are described in this chapter. Select Advanced Setup from the AMIBIOS Setup main menu to display the Advanced Setup options.

Default Settings

Every option in AMIBIOS Setup contains two default values: an Fail-Safe default and the Optimal default value.

Optimal Defaults

The Optimal default values provide optimum performance settings for all devices and system features.

Fail-Safe Defaults

The Fail-Safe default settings consist of the safest set of parameters. Use them if the system is behaving erratically. They should always work but do not provide optimal system performance characteristics.

Advanced Setup

Quick Boot

Set this option to Enabled to instruct AMIBIOS to boot quickly when the computer is powered on. This option replaces the old Above 1 MB Memory Test Advanced Setup option. The settings are:

Setting	Description
Disabled	AMIBIOS tests all system memory. AMIBIOS waits up to 40 seconds for a READY signal from the IDE hard disk drive. AMIBIOS waits for .5 seconds after sending a RESET signal to the IDE drive to allow the IDE drive time to get ready again. AMIBIOS checks for a key press and runs AMIBIOS Setup if the key has been pressed.
Enabled	AMIBIOS does not test system memory above 1MB. AMIBIOS does not wait up to 40 seconds for a READY signal from the IDE hard disk drive. If a READY signal is not received immediately from the IDE drive, AMIBIOS does not configure that drive. AMIBIOS does not wait for .5 seconds after sending a RESET signal to the IDE drive to allow the IDE drive time to get ready again. You cannot run AMIBIOS Setup at system boot, because there is no delay for the Hit to run Setup message.

The Optimal and Fail-Safe default settings are Disabled.

1st Boot Device

This option sets the type of device for the first boot drives that the AMIBIOS attempts to boot from after AMIBIOS POST completes. The settings are Disabled, Network, Floptical, SCSI, CDROM, IDE-0, IDE-1, IDE-2, or IDE-3. The Optimal and Fail-Safe default settings are IDE-0.

2nd Boot Device

This option sets the type of device for the second boot drives that the AMIBIOS attempts to boot from after AMIBIOS POST completes. The settings are Disabled, Floppy, Floptical, CDROM, or IDE-0. The Optimal and Fail-Safe default settings are Floppy.

3rd Boot Device

This option sets the type of device for the third boot drives that the AMIBIOS attempts to boot from after AMIBIOS POST completes. The settings are Disabled, Floptical, Floppy, CDROM, or IDE-0. The Optimal and Fail-Safe default settings are CD-ROM.

Try Other Boot Devices

Set this option to Yes to instruct AMIBIOS to attempt to boot from any other drive in the system if it cannot find a boot drive among the drives specified in the 1st Boot Device, 2nd Boot Device, and 3rd Boot Device options. The settings are Yes or No. The Optimal and Fail-Safe default settings are Yes.

Initial Display Mode

This option specifies the initial display mode when the system boots. The settings are as follows:

Setting	Description
BIOS	The messages that AMIBIOS displays before booting the system will appear on the system monitor.
Silent	The messages that AMIBIOS displays will not appear on the system monitor.

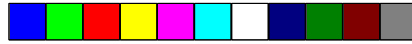

Display Mode At Add-On ROM Init

This option specifies the system display mode that is set at the time that AMIBIOS POST initializes an optional option ROM. The settings are as follows:

Setting	Description
Force BIOS	The display mode currently being used by AMIBIOS is used.
Keep Current	The current display mode is used.

Floppy Access Control

This option specifies the read/write access that is set when booting from a floppy drive. The settings are Read/Write or Read-Only. The Optimal and Fail-Safe default settings are Read/Write.

Hard Disk Access Control

This option specifies the read/write access that is set when booting from a hard disk drive. The settings are Read/Write or Read-Only. The Optimal and Fail-Safe default settings are Read/Write.

S.M.A.R.T. For Hard Disks

Set this option to Enabled to permit AMIBIOS to use the SMART (System Management and Reporting Technologies) protocol for reporting server system information over a network. Enabling this feature allows you to back up your data when your hard disk is about to fail. The settings are Enabled or Disabled. The Optimal and Fail-Safe default settings are Disabled.

Boot Up Num Lock

Set this option to Off to turn the Num Lock key off when the computer is booted so you can use the arrow keys on both the numeric keypad and the keyboard. The settings are On or Off. The default settings are On.





TYAN Chapter 4 COMPUTER

PS/2 Mouse Support

Set this option to Enabled to enable AMIBIOS support for a PS/2-type mouse. The BIOS will allocate IRQ12 for the PS/2 mouse. The settings are Enabled or Disabled. The Optimal and Fail-Safe default settings are Enabled.

Primary Display

This option configures the type of monitor attached to the computer. The settings are Mono, CGA40x25, CGA80x25, VGA/EGA, or Absent. The Optimal and Fail-Safe default settings are VGA/EGA.

Password Check

This option enables password checking every time the system boots or when you run AMIBIOS Setup. If Always is chosen, a user password prompt appears every time the computer is turned on. If Setup is chosen, the password prompt appears if AMIBIOS is executed. See the Advanced Setup chapter for instructions on changing a password. The Optimal and Fail-Safe defaults are Setup.

Boot To OS/2

Set this option to Enabled if running OS/2 operating system and using more than 64 MB of system memory on the motherboard. The settings are Enabled or Disabled. The Optimal and Fail-Safe default settings are Disabled.

CPU Microcode Update

Set this option to Enabled to permit the BIOS to update the CPU at any time. The settings are Enabled or Disabled. The Optimal and Fail-Safe default settings are Enabled.

Internal Cache

This option sets the type of caching algorithm used by the L1 internal cache memory on the CPU. The settings are WriteBack, WriteThru, or Disabled. The Optimal and Fail-Safe default settings are Disabled.

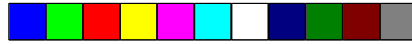

System BIOS Cacheable

When set to Enabled, the contents of the F0000h system memory segment can be read from or written to cache memory. The contents of this memory segment are always copied from the BIOS ROM to system RAM for faster execution. The settings are Enabled or Disabled. The Optimal default setting is Enabled. The Fail-Safe default setting is Disabled.

C000,16K Shadow and C400,16K Shadow

These options specify how the 32 KB of video ROM at C0000h is treated. The settings are:

Setting	Description
Disabled	The contents of the video ROM are not copied to RAM.
Enabled	The contents of the video ROM area from C000h-C7FFFh are copied (shadowed) from ROM to RAM for faster execution.
Cached	The contents of the video ROM area from C000h-C7FFFh are copied from ROM to RAM and can be written to or read from cache memory.

The Optimal and Fail-Safe default settings are Cached.

C800,16K Shadow; CC00,16K Shadow; D000,16K Shadow; D400,16K Shadow; D800, 16K Shadow; and DC00,16K Shadow

These options enable shadowing of the contents of the ROM area named in the option. The ROM area not used by ISA adapter cards is allocated to PCI adapter cards. The settings are:

Setting	Description
Disabled	The contents of the video ROM are not copied to RAM.
Enabled	The contents of the video ROM area from C000h-C7FFFh are copied (shadowed) from ROM to RAM for faster execution.
Cached	The contents of the video ROM area from C000h-C7FFFh are copied from ROM to RAM and can be written to or read from cache memory.

The Optimal and Fail-Safe default settings are Cached.



Chipset Setup

Choose Chipset Setup on the AMIBIOS Setup main menu. All Chipset Setup options are then displayed. AMIBIOS Setup can be customized. AMIBIOS Setup can be customized via AMIBCP. See the AMIBIOS Utilities Guide for additional information.

USB Function

Set this option to Enabled to enable USB (Universal Serial Bus) support. The settings are Enabled or Disabled. The Optimal and Fail-Safe default settings are Enabled.

USB Keyboard/Mouse Legacy Support

Set this option to Enabled to enable support for older keyboards and mouse devices if the USB Function option is set to Enabled. The settings are Enabled or Disabled. The Optimal and Fail-Safe default settings are Disabled.

EDO DRAM Speed (ns)

This option specifies the RAS Access Time in nanoseconds for the EDO DRAM system memory installed in this computer. The settings are Auto (AMIBIOS automatically determines the RAS access Time parameter), Manual, 50, 60, or 70. The Optimal and Fail-Safe default settings are Auto.

EDO Read Burst Timing

This option specifies the timings for EDO DRAM system memory for Read operations in burst mode. The settings are x222 or x333. The Optimal and Fail-Safe default settings are x333. Setting this switch incorrectly may result in system failure.

EDO Write Burst Timing

This option specifies the timings for EDO DRAM system memory for Write operations in burst mode. The settings are x222 or x333. The Optimal and Fail-Safe default settings are x333. Setting this switch incorrectly may result in system failure.

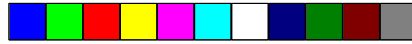

EDO RAS Precharge

This option specifies the length of the RAS precharge part of the DRAM system memory access cycle when EDO DRAM system memory is installed in this computer. The settings are 3 CLKs or 4 CLKs. The Optimal and Fail-Safe default settings are 4 CLKs.

EDO RAS To CAS

This option specifies the length of the delay inserted between the RAS and CAS signals of the DRAM system memory access cycle when EDO DRAM system memory is installed in this computer. The settings are 2 CLKs or 3 CLKs. The Optimal and Fail-Safe default settings are 3 CLKs.

MA Wait State

This option specifies the length of the delay inserted between MA signals. The settings are Slow or Fast. The Optimal and Fail-Safe default settings are Slow.

SDRAM Timing Latency

This option specifies the latency for the Synchronous DRAM system memory signals. The settings are Auto (AMIBIOS automatically determines the optimal delay) or Manual. The Optimal and Fail-Safe default settings are Auto.

RAS To CAS

This option specifies the length of the delay inserted between the RAS and CAS signals of the DRAM system memory access cycle. The settings are 2 CLKs or 3 CLKs. The Optimal and Fail-Safe default settings are 3 CLKs.

CAS Lat.

This option sets the latency period for the CAS signal. The settings are 2 CLKs or 3 CLKs. The Optimal and Fail-Safe default settings are 3 CLKs.



BIOS



RAS Precharge

This option specifies the length of the RAS precharge part of the DRAM system memory access cycle when EDO DRAM system memory is installed in this computer. The settings are 3 CLKs or 4 CLKs. The Optimal and Fail-Safe default settings are 4 CLKs.

VGA Frame Buffer USWC

Set this option to Enabled to enable the VGA video frame buffer using USWC (Uncacheable, Speculatable, Write-Combined) memory. The settings are Enabled or Disabled. Older ISA VGA card drivers may not behave correctly if this option is not set to Disabled. The Optimal and Fail-Safe default settings are Disabled.

PCI Frame Buffer USWC

Set this option to Enabled to enable the USWC memory attribute and improve video performance when a PCI video adapter is installed. However, some VGA card drivers may not behave correctly when this option is set to Enabled. The settings are Disabled or Enabled. The Optimal and Fail-Safe defaults are Disabled.

DRAM Integrity Mode

This option sets the type of system memory checking. The settings are:

Setting	Description
Non ECC	No error checking or error reporting is done.
ECC Only	Multibit errors are detected and reported as parity errors. Single-bit errors are corrected by the chipset. Corrected bits of data from memory are not written back to DRAM system memory. If <i>Level 1</i> is selected, the J25 External SMI software jumper on the Series 745 board is disabled.
ECC	Multibit errors are detected and reported as parity errors. Single bit errors are corrected by the chipset and are written back to DRAM system memory. If a soft (correctable) memory error occurs, writing the fixed data back to DRAM system memory will resolve the problem. If a hard (uncorrectable) error occurs, writing the fixed data back to DRAM system memory does not solve the problem. In this case, the second time the error occurs in the same location, a parity error is reported, indicating an uncorrectable error. If <i>ECCI</i> is selected, AMIBIOS automatically enables the System Management Interface (SMI). If you do not want to enable power management, set the Power Management/APM option to <i>Disabled</i> and set all Power Management Setup timeout options to <i>Disabled</i> . To enable power management, set Power Management/APM to <i>Enabled</i> and set the Power Management Setup timeout options as desired.



Fixed Memory Hole

This option specifies the location of an area of memory that cannot be addressed on the ISA bus. The settings are Disabled, 15 MB-16 MB, or 512KB-640KB. The Optimal and Fail-Safe default settings are Disabled.

TypeF DMA BufferControl1 and TypeF DMA Buffer Control2

These options specify the DMA channel where TypeF buffer control is implemented. The settings are Disabled, Channel-0, Channel-1, Channel-2, Channel-3, Channel-5, Channel-6, or Channel-7. The Optimal and Fail-Safe default settings are Disabled.

DMA-0 Type, DMA-1 Type, DMA-2 Type, DMA-3 Type, DMA-5 Type, DMA-6 Type, DMA-7 Type

These options specify the bus that the specified DMA channel can be used on. The settings are PC/PCI, Distributed, or Normal ISA. The Optimal and Fail-Safe default settings are Normal ISA.

AGP Aperture Size

This option specifies the amount of system memory that can be used by the Accelerated Graphics Port (AGP). The settings are 4 MB, 8 MB, 16 MB, 32 MB, 64 MB, 128 MB, or 256 MB. The Optimal and Fail-Safe default settings are 256 MB.

System Type

This option sets the system type. The settings are Auto (AMIBIOS automatically determines the system type), DP, or UP. The Optimal and Fail-Safe default settings are Auto.



USWC Write I/O Post

This option sets the status of USWC posted writes to I/O. The settings are:

Setting	Description
Enabled	USWC posted writes to I/O are enabled.
Disabled	USWC posted writes to I/O are disabled.
Auto	AMIBIOS automatically determines if USWC posted writes to I/O should be enabled and sets this option accordingly.

The Optimal and Fail-Safe default settings are Auto.

MECC Buf. Strength

This option sets the strength of the signal for the MECC buffer. The settings are Auto (AMIBIOS automatically determines the correct setting), 42mA, 38mA, or 33mA. The Optimal and Fail-Safe default settings are Auto.

MD Buf. Strength

This option sets the strength of the signal for the MD buffer. The settings are Auto (AMIBIOS automatically determines the correct setting), 42mA, 38mA, or 33mA. The Optimal and Fail-Safe default settings are Auto.

WE Buf. Strength

This option sets the strength of the signal for the WE buffer. The settings are Auto (AMIBIOS automatically determines the correct setting), 42mA, 38mA, or 33mA. The Optimal and Fail-Safe default settings are Auto.

MAX Buf. Strength

This option sets the strength of the signal for the MAX buffer. The settings are Auto (AMIBIOS automatically determines the correct setting), 42mA, 38mA, or 33mA. The Optimal and Fail-Safe default settings are Auto.

MA Buf. Strength

This option sets the strength of the signal for the MA buffer. The

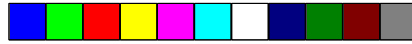

settings are Auto (AMIBIOS automatically determines the correct setting), 48mA, 42mA, or 22mA. The Optimal and Fail-Safe default settings are Auto.

SCAS3 Buf. Strength

This option sets the strength of the signal for the SCAS3 buffer. The settings are Auto (AMIBIOS automatically determines the correct setting), 48mA, 42mA, or 22mA. The Optimal and Fail-Safe default settings are Auto.

SCAS2:0 Buf. Strength

This option sets the strength of the signal for the SCAS2:0 buffer. The settings are Auto (AMIBIOS automatically determines the correct setting), 42mA, 38mA, or 33mA. The Optimal and Fail-Safe default settings are Auto.

SRAS3 Buf. Strength

This option sets the strength of the signal for the SRAS3 buffer. The settings are Auto (AMIBIOS automatically determines the correct setting), 48mA, 42mA, or 22mA. The Optimal and Fail-Safe default settings are Auto.

SRAS2:0 Buf. Strength

This option sets the strength of the signal for the SRAS2:0 buffer. The settings are Auto (AMIBIOS automatically determines the correct setting), 48mA, 42mA, or 22mA. The Optimal and Fail-Safe default settings are Auto.

DQMX5 Buf. Strength

This option sets the strength of the signal for the DQMX5 buffer. The settings are Auto (AMIBIOS automatically determines the correct setting), 42mA, 38mA, or 33mA. The Optimal and Fail-Safe default settings are Auto.

DQMX1 Buf. Strength

This option sets the strength of the signal for the DQMX1 buffer. The settings are Auto (AMIBIOS automatically determines the correct



setting), 42mA, 38mA, or 33mA. The Optimal and Fail-Safe default settings are Auto.

DQM Buf. Strength

This option sets the strength of the signal for the DQM buffer. The settings are Auto (AMIBIOS automatically determines the correct setting), 42mA, 38mA, or 33mA. The Optimal and Fail-Safe default settings are Auto.

CSX Buf. Strength

This option sets the strength of the signal for the CSX buffer. The settings are Auto (AMIBIOS automatically determines the correct setting), 48mA, 42mA, or 22mA. The Optimal and Fail-Safe default settings are Auto.

CS7:6 Buf. Strength

This option sets the strength of the signal for the CS7:6 buffer. The settings are Auto (AMIBIOS automatically determines the correct setting), 48mA, 42mA, or 22mA. The Optimal and Fail-Safe default settings are Auto.

CS5:0 Buf. Strength

This option sets the strength of the signal for the CS5:0 buffer. The settings are Auto (AMIBIOS automatically determines the correct setting), 48mA, 42mA, or 22mA. The Optimal and Fail-Safe default settings are Auto.

PAC Bus SERR#

Set this option to Enabled to enable the SERR# signal on the PAC bus. The settings are Enabled or Disabled. The Optimal and Fail-Safe default settings are Enabled.

AGP Common SERR#

Set this option to Enabled to permit a common SERR# signal for AGP and the standard PC bus. The settings are Enabled or Disabled. The Optimal and Fail-Safe default settings are Enabled.

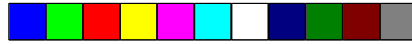

AGP System Error Forwarding

Set this option to Enabled to enable AGP system errors to be forwarded. The settings are Enabled or Disabled. The Optimal and Fail-Safe default settings are Enabled.

AGP Parity Error Response

Set this option to Enabled to enable AGP parity error response. The settings are Enabled or Disabled. The Optimal and Fail-Safe default settings are Enabled.

IRQ12

This option specifies how IRQ12 is used. The settings are:

Setting	Description
Auto	AMIBIOS automatically determines how IRQ12 should be allocated.
Standard	IRQ12 is made available for use on the ISA BUS.
Mouse	IRQ12 is used by the PS/2 mouse.

The Optimal and Fail-Safe default settings are Auto.

PIIX4 SERR#

Set this option to Enabled to enable the SERR# signal for the Intel PIIX4 chip. The settings are Enabled or Disabled. The Optimal and Fail-Safe default settings are Disabled.

USB Passive Release Enable

Set this option to Enabled to enable passive release for USB. The settings are Enabled or Disabled. The Optimal and Fail-Safe default settings are Disabled.

PIIX4 Passive

Set this option to Enabled to enable passive release for the Intel PIIX4 chip. The settings are Enabled or Disabled. The Optimal and Fail-Safe default settings are Enabled.

PIIX4 Delayed Transaction

Set this option to Enabled to enable delayed transactions for the Intel





TYAN Chapter 4 COMPUTER

PIIX4 chip. The settings are Enabled or Disabled. The Optimal and Fail-Safe default settings are Enabled.

Master Lat. Timer

This option specifies the latency for the Timer. The settings are 00h through F8h in increments of 08h. The settings are 00h.



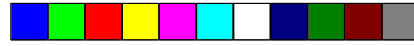

Power Management Setup

The AMIBIOS Setup options described in this section are selected by choosing Power Management Setup from the AMIBIOS Setup main menu.

ACPI Aware OS

Set this option to Enabled to enable Advanced Configuration and Power Interface (ACPI) BIOS for an ACPI-aware operating system.

Power Management/APM

Set this option to Enabled to enable the chipset power management and APM (Advanced Power Management) features. The settings are Enabled or Disabled. The Optimal and Fail-Safe default settings are Disabled.

Power Button Function

This option specifies how the power button mounted externally on the computer chassis is used. The settings are:

Setting	Description
On/Off	Pushing the power button turns the computer on or off.
Suspend	Pushing the power button places the computer in Suspend mode or Full On power mode.

The Optimal and Fail-Safe default settings are On/Off.

Instant On Support

Set this option to Enabled to enable AMIBIOS support for the Intel InstantON specification. The settings are Enabled or Disabled. The Optimal and Fail-Safe default settings are Disabled.

Green PC Monitor Power State

This option specifies the power state that the green PC-compliant video monitor enters when AMIBIOS places it in a power saving state after the specified period of display inactivity has expired. The settings



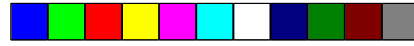

TYAN Chapter 4 COMPUTER

are Off, Standby, Suspend, or Disabled. The Optimal and Fail-Safe default settings are Disabled.

Video Power Down Mode

This option specifies the power state that the video subsystem enters when AMIBIOS places it in a power saving state after the specified period of display inactivity has expired. The settings are Standby, Suspend or Disabled. The Optimal and Fail-Safe default settings are Disabled.

Hard Disk Power Down Mode

This option specifies the power conserving state that the hard disk drive enters after the specified period of hard drive inactivity has expired. The settings are Disabled, Standby, or Suspend. The Optimal and Fail-Safe default settings are Disabled.

Hard Disk Timeout (Minute)

This option specifies the length of a period of hard disk drive inactivity. When this length of time expires, the computer enters power-conserving state specified in the Hard Disk Power Down Mode option (see the previous page). The settings are Disabled, 1 min. (minute), 2 min., 3 min., 4 min., 5 min., 6 min., 7 min., 8 min., 9 min., 10 min., 11 min., 12 min., 13 min., 14 min., and 15 min. The Optimal and Fail-Safe default settings are Disabled.

Standby/Suspend Timer Unit

This option specifies the unit of time used for the Standby and Suspend timeout periods. The settings are 4 msec, 4 sec, 32 sec, or 4 min. The Optimal and Fail-Safe default settings are 4 min.

Standby Timeout

This option specifies the length of a period of system inactivity while in Full power on state. When this length of time expires, the computer enters Standby power state. The settings are Disabled, 4 msec, 8 msec, 12 msec, 16 msec, up to 508 msec, in increments of 4 msec. The Optimal and Fail-Safe default settings are Disabled.

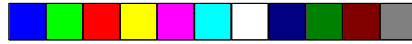

Suspend Timeout

This option specifies the length of a period of system inactivity while in Standby state. When this length of time expires, the computer enters Suspend power state. The settings are Disabled, 4 msec, 8 msec, 12 msec, 16 msec, up to 508 msec, in increments of 4 msec. The Optimal and Fail-Safe default settings are Disabled.

Slow Clock Ratio

This option specifies the speed at which the system clock runs in the Standby Mode power saving state. The settings are expressed as a percentage between the normal CPU clock speed and the CPU clock speed when the computer is in the power-conserving state. The settings are 0-12.5%, 12.5-25%, 25-37.5%, 37.5-50%, 50-62.5%, 62.5-75%, or 75-87.5%. The Optimal and Fail-Safe default settings are 50-62.5%.

Display Activity

When set to Monitor, this option enables event monitoring on the video display. If set to Monitor and the computer is in a power saving state, AMIBIOS watches for display activity. The computer enters the Full On state if any activity occurs. AMIBIOS reloads the Standby and Suspend timeout timers if display activity occurs. The settings are Monitor or Ignore. The Optimal and Fail-Safe default settings are Ignore.

Device 6 (Serial Port 1), Device 7 (Serial Port 2), Device 8 (Parallel Port), Device 5 (Floppy Disk), Device 0 (Primary Master IDE), Device 1 (Primary Slave IDE), Device 2 (Secondary Master IDE), and Device 3 (Secondary Slave IDE)

When set to Monitor, these options enable event monitoring on the specified hardware interrupt request line. If set to Monitor and the computer is in a power saving state, AMIBIOS watches for activity on the specified IRQ line. The computer enters the Full On state if any activity occurs. AMIBIOS reloads the Standby and Suspend timeout timers if activity occurs on the specified IRQ line. The settings for each of these options are Monitor or Ignore. The Optimal and Fail-Safe default settings are Ignore.



PCI/PnP Setup

Choose PCI/Plug and Play Setup from the AMIBIOS Setup screen to display the PCI and Plug and Play Setup options, described below.

Plug and Play Aware O/S

Set this option to Yes to inform AMIBIOS that the operating system can handle plug and Play (PnP) devices. The settings are No or Yes. The Optimal and Fail-Safe default settings are No.

PCI Latency Timer (PCI Clocks)

This option specifies the latency timings (in PCI clocks) for PCI devices installed in the PCI expansion slots. The settings are 32, 64, 96, 128, 160, 192, 224, or 248. The Optimal and Fail-Safe default settings are 64.

PCI VGA Palette Snoop

When this option is set to Enabled, multiple VGA devices operating on different buses can handle data from the CPU on each set of palette registers on every video device. Bit 5 of the command register in the PCI device configuration space is the VGA Palette Snoop bit (0 is disabled). For example, if there are two VGA devices in the computer (one PCI and one ISA) and this field is set for:

Setting	Description
Disabled	Data read and written by the CPU is only directed to the PCI VGA device's palette registers.
Enabled	Data read and written by the CPU is directed to the both the PCI VGA device's palette registers and the ISA VGA device palette registers, permitting the palette registers of both devices to be identical.

This option must be set to Enabled if any ISA adapter card installed in the system requires VGA palette snooping. The Optimal and Fail-Safe default settings are Disabled.

Allocate IRQ To PCI VGA

Set this option to Yes to allocate an IRQ to the VGA device on the PCI bus. The settings are Yes or No. The Optimal and Fail-Safe default settings are Yes.

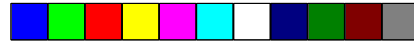

PCI IDE Bus Master

Set this option to Enabled to specify that the IDE controller on the PCI bus has bus mastering capability. The settings are Disabled or Enabled. The Optimal and Fail-Safe default settings are Disabled.

Offboard PCI IDE Card

This option specifies if an offboard PCI IDE controller adapter card is used in the computer. You must also specify the PCI expansion slot on the motherboard where the offboard PCI IDE controller card is installed. If an offboard PCI IDE controller is used, the motherboard onboard IDE controller is automatically disabled. The settings are Disabled, Auto, Slot1, Slot2, Slot3, Slot4, Slot5, or Slot6. If Auto is selected, AMIBIOS automatically determines the correct setting. The Optimal and Fail-Safe default settings are Auto. This option forces IRQ 14 and 15 to a PCI slot on the PCI local bus. This is necessary to support non-compliant PCI IDE adapter cards.

Offboard PCI IDE Primary IRQ

This option specifies the PCI interrupt used by the primary IDE channel on the offboard PCI IDE controller. The settings are Disabled, Hardwired, INTA, INTB, INTC, or INTD. The Optimal and Fail-Safe default settings are Disabled.

Offboard PCI IDE Secondary IRQ

This option specifies the PCI interrupt used by the secondary IDE channel on the offboard PCI IDE controller. The settings are Disabled, Hardwired, INTA, INTB, INTC, or INTD. The Optimal and Fail-Safe settings are Disabled.

PCI Slot1 IRQ Priority, PCI Slot2 IRQ Priority, PCI Slot3 IRQ Priority, and PCI Slot4 IRQ Priority

These options specify the IRQ priority for PCI devices installed in the PCI expansion slots. The settings are Auto, (IRQ) 3, 4, 5, 7, 9, 10, and 11, in order of priority. The Optimal and Fail-Safe default settings are Auto.



DMA Channel 0, DMA Channel 1, DMA Channel 3, DMA Channel 5, DMA Channel 6, and DMA Channel 7

These options allow you to specify the bus type used by each DMA channel. The settings are PnP or ISA/EISA. The Optimal and Fail-Safe default settings are PnP.

IRQ3, IRQ4, IRQ5, IRQ7, IRQ9, IRQ10, IRQ11, IRQ12, IRQ14, and IRQ15

These options specify the bus that the specified IRQ line is used on. These options allow you to reserve IRQs for legacy ISA adapter cards. These options determine if AMIBIOS should remove an IRQ from the pool of available IRQs passed to devices that are configurable by the system BIOS. The available IRQ pool is determined by reading the ESCD NVRAM. If more IRQs must be removed from the pool, the end user can use these options to reserve the IRQ by assigning an ISA/EISA setting to it. Onboard I/O is configured by AMIBIOS. All IRQs used by onboard I/O are configured as PCI/PnP. IRQ12 only appears if the Mouse Support option in Advanced Setup is set to Disabled. IRQ14 and 15 will not be available if the onboard PCI IDE is enabled. If all IRQs are set to ISA/EISA and IRQ14 and 15 are allocated to the onboard PCI IDE, IRQ9 will still be available for PCI and PnP devices, because at least one IRQ must be available for PCI and PnP devices. The settings are ISA/EISA or PCI/PnP. The Optimal and Fail-Safe default settings are PCI/PnP.

Reserved Memory Size

This option specifies the size of the memory area reserved for legacy ISA adapter cards. The settings are Disabled, 16K, 32K, or 64K. The Optimal and Fail-Safe default settings are Disabled.

Reserved Memory Address

This option specifies the beginning address (in hex) of the reserved memory area. The specified ROM memory area is reserved for use by legacy ISA adapter cards. This option does not appear if the Reserved Memory Size option is set to Disabled. The settings are C0000, C4000, C8000, CC000, D0000, D4000, D8000, or DC000. The Optimal and Fail-Safe default settings are N/A.

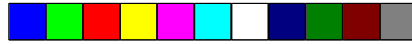

Peripheral Setup

Peripheral Setup options are displayed by choosing Peripheral Setup from the AMIBIOS Setup main menu. All Peripheral Setup options are described here.

Onboard FDC

Set this option to Enabled to enable the floppy drive controller on the motherboard. The settings are Auto (AMIBIOS automatically determines if the floppy controller should be enabled), Enabled, or Disabled. The Optimal and Fail-Safe default settings are Enabled.

Onboard Serial Port1

This option specifies the base I/O port address of serial port 1. The settings are Auto (AMIBIOS automatically determines the correct base I/O port address), Disabled, 3F8h, 2F8h, 2E8h, or 3E8h. The Optimal and Fail-Safe default settings are Auto.

Onboard Serial Port2

This option specifies the base I/O port address of serial port 2. The settings are Auto (AMIBIOS automatically determines the correct base I/O port address), Disabled, 3F8h, 2F8h, 2E8h, or 3E8h. The Optimal and Fail-Safe default settings are Auto.

Serial Port2 Mode

This option specifies the operating mode for serial port 2. This option only appears if the Onboard Serial Port2 option is not set to Auto or Disabled. The settings are IrDA, ASK IR, or Normal. The Optimal and Fail-Safe default settings are Normal.

IR Transmission Mode

This option specifies the infrared transmission method. This option only appears if the Onboard Serial Port2 option is not set to Auto or Disabled. The settings are Full Duplex or Half Duplex. There are no default settings.

BIOS

Receiver Polarity

This option specifies if the IRQ signal for IR transmission is Active High or Active Low. The settings are Active High or Active Low. There are no default settings.

Transmitter Polarity

This option specifies if the IRQ signal for IR transmission is Active High or Active Low. The settings are Active High or Active Low. There are no default settings.

Onboard Parallel Port

This option specifies the base I/O port address of the parallel port on the motherboard. The settings are Disabled, 378h, 278h, or 3BCh. The Optimal default setting is 378h. The Fail-Safe default setting is Disabled.

Parallel Port Mode

This option specifies the parallel port mode. The Optimal default setting is Normal. The Fail-Safe default setting is Disabled. The settings are:

Setting	Description
Normal	The normal parallel port mode is used.
Bi-Dir	Use this setting to support bidirectional transfers on the parallel port.
EPP	The parallel port can be used with devices that adhere to the Enhanced Parallel Port (EPP) specifications. EPP uses the existing parallel port signals to provide asymmetric bidirectional data transfer driven by the host device.
ECP	The parallel port can be used with devices that adhere to the Extended Capabilities Port (ECP) specifications. ECP uses the DMA protocol to achieve data transfer rates of up to 2.5 Megabits per second. ECP provides symmetric bidirectional communication.

EPP Version

This option specifies the Enhanced Parallel Port specification version number that is used in the system. This option only appears if the Parallel Port Mode option is set to EPP. The settings are 1.7 or 1.9. There are no Optimal and Fail-Safe default settings because the default setting for the Parallel Port Mode option is not EPP.

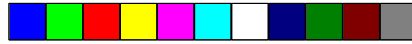

Parallel Port IRQ

This option specifies the IRQ used by the parallel port. The settings are Auto, (IRQ) 5, or (IRQ) 7. The Optimal and Fail-Safe default settings are Auto.

Parallel Port DMA Channel

This option is only available if the setting for the Parallel Port Mode option is ECP. This option sets the DMA channel used by the parallel port. The settings are DMA Channel 0, 1, or 3. The Optimal and Fail-Safe default settings are not provided.

Onboard IDE

This option specifies the IDE channel used by the onboard IDE controller. The settings are Disabled, Primary, or Secondary. The Optimal and Fail-Safe default settings are Disabled.

Onboard SCSI

This option will enable or disable the onboard SCSI BIOS. The default setting is Enabled.

Power Interruption

Enabling this option will allow the system to return to power on stage when interrupted by a power outage.

Sound

This option allows you to manually select an IRQ, address, and DMA number for the sound chip. The default setting is Auto.

Port Bar Joystick

This option enables or disables the game port connector onboard.



Flash Writer Utility

The AMI Flash Writer Utility is now included in the AMIBIOS, and so it is simpler to upgrade the BIOS of your mainboard. The system BIOS is stored on a flash EEPROM ROM chip on the mainboard which can be erased and reprogrammed by following the directions below.

1. Rename the BIOS file that you have downloaded to “amiboot.rom” and copy it on to a floppy disk.
2. Insert the floppy disk with the BIOS upgrade into the A: drive.
3. Turn the power off.
4. While holding the <Ctrl> and <Home> keys, turn the power on. The system will begin to read from the A: drive, and write the BIOS information contained on the floppy disk in that drive to the EEPROM ROM chip. When the BIOS has been totally reprogrammed, you will hear three beeps and the system will reboot with the new BIOS in operation.
5. If the system does not reboot in three minutes, power down the system, wait a few seconds, and then turn the power back on again.



TYAN
COMPUTER



This page has been left blank intentionally.



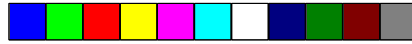

chapter 5

System Resources

POST Checkpoint Codes

When AMIBIOS performs the Power On Self Test, it writes diagnostic codes (checkpoint codes) to I/O port 0080h. If the computer cannot complete the boot process, diagnostic equipment can be attached to the computer to read I/O port 0080h. The following AMIBIOS POST checkpoint codes are valid for all AMIBIOS products with a core BIOS date of 7/15/95 (Enhanced).

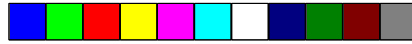

Uncompressed Initialization Codes

The uncompressed initialization codes are listed in order of execution.

Checkpoint Code	Description
D0h	The NMI is disabled. Power on delay is starting. Next, the initialization code checksum will be verified.
D1h	Initializing the DMA controller, performing the keyboard controller BAT test, starting memory refresh, and entering 4 GB flat mode next.
D3h	Starting memory sizing next.
D4h	Returning to real mode. Executing any OEM patches and setting the stack next.
D5h	Passing control to the uncompressed code in shadow RAM at E000:0000h. The initialization code is copied to segment 0 and control will be transferred to segment 0.
D6h	Control is in segment 0. Next, checking if <Ctrl> <Home> was pressed and verifying the system BIOS checksum. If <Ctrl> <Home> was pressed or the system BIOS checksum is bad, next will go to checkpoint code E0h. Otherwise, going to D7h.
D7h	Passing control to the interface module next.
D8h	The main system BIOS runtime code will be decompressed next.
D9h	Passing control to the main system BIOS in shadow RAM next.

SYSTEM

Bootblock Recovery Codes

The bootblock recovery checkpoint codes are listed in order of execution.

Checkpoint Code	Description
E0h	The onboard floppy controller if available is initialized. Next, beginning the base 512 KB memory test.
E1h	Initializing the interrupt vector table next.
E2h	Initializing the DMA and Interrupt controllers next.
E6h	Enabling the floppy drive controller and Timer IRQs. Enabling internal cache memory.
EDh	Initializing the floppy drive.
EEh	Looking for a floppy diskette in drive A:. Reading the first sector of the diskette.
EFh	A read error occurred while reading the floppy drive in drive A:.
F0h	Next, searching for the AMIBOOT.ROM file in the root directory.
F1h	The AMIBOOT.ROM file is not in the root directory.
F2h	Next, reading and analyzing the floppy diskette FAT to find the clusters occupied by the AMIBOOT.ROM file.
F3h	Next, reading the AMIBOOT.ROM file, cluster by cluster.
F4h	The AMIBOOT.ROM file is not the correct size.
F5h	Next, disabling internal cache memory.
FBh	Next, detecting the type of flash ROM.
FCh	Next, erasing the flash ROM.
FDh	Next, programming the flash ROM.
FFh	Flash ROM programming was successful. Next, restarting the system BIOS.

Uncompressed Initialization Codes

The following routine checkpoint codes are listed in order of execution. These codes are uncompressed in F000h shadow RAM. The table begins on the next page.

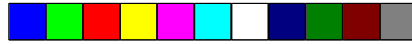

Checkpoint Code	Description
03h	The NMI is disabled. Next, checking for a soft reset or a power on condition.
05h	The BIOS stack has been built. Next, disabling cache memory.
06h	Uncompressing the POST code next.
07h	Next, initializing the CPU and the CPU data area.
08h	The CMOS checksum calculation is done next.
0Bh	Next, performing any required initialization before the keyboard BAT command is issued.
0Ch	The keyboard controller input buffer is free. Next, issuing the BAT command to the keyboard controller.
0Eh	The keyboard controller BAT command result has been verified. Next, performing any necessary initialization after the keyboard controller BAT command test.
0Fh	The initialization after the keyboard controller BAT command test is done. The keyboard command byte is written next.
10h	The keyboard controller command byte is written. Next, issuing the Pin 23 and 24 blocking and unblocking commands.
11h	Next, checking if the <End> or <Ins> keys were pressed during power on. Initializing CMOS RAM if the Initialize CMOS RAM in every boot AMIBIOS POST option was set in AMIBCP or the <End> key was pressed.
12h	Next, disabling DMA controllers 1 and 2 and interrupt controllers 1 and 2.
13h	The video display has been disabled. Port B has been initialized. Next, initializing the chipset.
14h	The 8254 timer test will begin next.
19h	The 8254 timer test is over. Starting the memory refresh test next.
1Ah	The memory refresh line is toggling. Checking the 15 second on/off time next.
23h	Reading the 8042 input port and disabling the MEGAKEY Green PC feature next. Making the BIOS code segment writable and performing any necessary configuration before initializing the interrupt vectors.
24h	The configuration required before interrupt vector initialization has completed. Interrupt vector initialization is about to begin.
25h	Interrupt vector initialization is done. Clearing the password if the POST DIAG switch is on.
27h	Any initialization before setting video mode will be done next.
28h	Initialization before setting the video mode is complete. Configuring the monochrome mode and color mode settings next.
2Ah	Bus initialization system, static, output devices will be done next, if present. See page 71 for additional information.
2Bh	Passing control to the video ROM to perform any required configuration before the video ROM test.

TYAN Chapter 5
COMPUTER

Checkpoint Code	Description
2Ch	All necessary processing before passing control to the video ROM is done. Looking for the video ROM next and passing control to it.
2Dh	The video ROM has returned control to BIOS POST. Performing any required processing after the video ROM had control.
2Eh	Completed post-video ROM test processing. If the EGA/VGA controller is not found, performing the display memory read/write test next.
2Fh	The EGA/VGA controller was not found. The display memory read/write test is about to begin.
30h	The display memory read/write test passed. Look for retrace checking next.
31h	The display memory read/write test or retrace checking failed. Performing the alternate display memory read/write test next.
32h	The alternate display memory read/write test passed. Looking for alternate display retrace checking next.
34h	Video display checking is over. Setting the display mode next.
37h	The display mode is set. Displaying the power on message next.
38h	Initializing the bus input, IPL, and general devices next, if present. See page 71 for additional information.
39h	Displaying bus initialization error messages. See page 71 for additional information.
3Ah	The new cursor position has been read and saved. Displaying the Hit message next.
40h	Preparing the descriptor tables next.
42h	The descriptor tables are prepared. Entering protected mode for the memory test next.
43h	Entered protected mode. Enabling interrupts for diagnostics mode next.
44h	Interrupts enabled if the diagnostics switch is on. Initializing data to check memory wraparound at 0:0 next.
45h	Data initialized. Checking for memory wraparound at 0:0 and finding the total system memory size next.
46h	The memory wraparound test has completed. The memory size calculation has been completed. Writing patterns to test memory next.
47h	The memory pattern has been written to extended memory. Writing patterns to the base 640 KB memory next.
48h	Patterns written in base memory. Determining the amount of memory below 1 MB next.
49h	The amount of memory below 1 MB has been found and verified. Determining the amount of memory above 1 MB memory next.
4Bh	The amount of memory above 1 MB has been found and verified. Checking for a soft reset and clearing the memory below 1 MB for the soft reset next. If this is a power on situation, going to checkpoint 4Eh next.

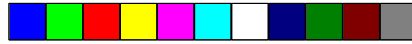

Checkpoint Code	Description
4Ch	The memory below 1 MB has been cleared via a soft reset. Clearing the memory above 1 MB next.
4Dh	The memory above 1 MB has been cleared via a soft reset. Saving the memory size next. Going to checkpoint 52h next.
4Eh	The memory test started, but not as the result of a soft reset. Displaying the first 64 KB memory size next.
4Fh	The memory size display has started. The display is updated during the memory test. Performing the sequential and random memory test next.
50h	The memory below 1 MB has been tested and initialized. Adjusting the displayed memory size for relocation and shadowing next.
51h	The memory size display was adjusted for relocation and shadowing. Testing the memory above 1 MB next.
52h	The memory above 1 MB has been tested and initialized. Saving the memory size information next.
53h	The memory size information and the CPU registers are saved. Entering real mode next.
54h	Shutdown was successful. The CPU is in real mode. Disabling the Gate A20 line, parity, and the NMI next.
57h	The A20 address line, parity, and the NMI are disabled. Adjusting the memory size depending on relocation and shadowing next.
58h	The memory size was adjusted for relocation and shadowing. Clearing the Hit message next.
59h	The Hit message is cleared. The <WAIT...> message is displayed. Starting the DMA and interrupt controller test next.
60h	The DMA page register test passed. Performing the DMA Controller 1 base register test next.
62h	The DMA controller 1 base register test passed. Performing the DMA controller 2 base register test next.
65h	The DMA controller 2 base register test passed. Programming DMA controllers 1 and 2 next.
66h	Completed programming DMA controllers 1 and 2. Initializing the 8259 interrupt controller next.
7Fh	Extended NMI source enabling is in progress.
80h	The keyboard test has started. Clearing the output buffer and checking for stuck keys. Issuing the keyboard reset command next.
81h	A keyboard reset error or stuck key was found. Issuing the keyboard controller interface test command next.
82h	The keyboard controller interface test completed. Writing the command byte and initializing the circular buffer next.
83h	The command byte was written and global data initialization has completed. Checking for a locked key next.

SYSTEM

TYAN Chapter 5
COMPUTER

Checkpoint Code	Description
84h	Locked key checking is over. Checking for a memory size mismatch with CMOS RAM data next.
85h	The memory size check is done. Displaying a soft error and checking for a password or bypassing WINBIOS Setup next.
86h	The password was checked. Performing any required programming before WINBIOS Setup next.
87h	The programming before WINBIOS Setup has completed. Uncompressing the WINBIOS Setup code and executing the AMIBIOS Setup or WINBIOS Setup utility next.
88h	Returned from WINBIOS Setup and cleared the screen. Performing any necessary programming after WINBIOS Setup next.
89h	The programming after WINBIOS Setup has completed. Displaying the power on screen message next.
8Bh	The first screen message has been displayed. The <WAIT...> message is displayed. Performing the PS/2 mouse check and extended BIOS data area allocation check next.
8Ch	Programming the WINBIOS Setup options next.
8Dh	The WINBIOS Setup options are programmed. Resetting the hard disk controller next.
8Fh	The hard disk controller has been reset. Configuring the floppy drive controller next.
91h	The floppy drive controller has been configured. Configuring the hard disk drive controller next.
95h	Initializing the bus option ROMs from C800 next. See page 71 for additional information.
96h	Initializing before passing control to the adaptor ROM at C800.
97h	Initialization before the C800 adaptor ROM gains control has completed. The adaptor ROM check is next.
98h	The adaptor ROM had control and has now returned control to BIOS POST. Performing any required processing after the option ROM returned control.
99h	Any initialization required after the option ROM test has completed. Configuring the timer data area and printer base address next.
9Ah	Set the timer and printer base addresses. Setting the RS-232 base address next.
9Bh	Returned after setting the RS-232 base address. Performing any required initialization before the Coprocessor test next.
9Ch	Required initialization before the Coprocessor test is over. Initializing the Coprocessor next.
9Dh	Coprocessor initialized. Performing any required initialization after the Coprocessor test next.
9Eh	Initialization after the Coprocessor test is complete. Checking the extended keyboard, keyboard ID, and Num Lock key next. Issuing the keyboard ID command next.

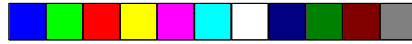

Checkpoint Code	Description
A2h	Displaying any soft errors next.
A3h	The soft error display has completed. Setting the keyboard typematic rate next.
A4h	The keyboard typematic rate is set. Programming the memory wait states next.
A5h	Memory wait state programming is over. Clearing the screen and enabling parity and the NMI next.
A7h	NMI and parity enabled. Performing any initialization required before passing control to the adaptor ROM at E000 next.
A8h	Initialization before passing control to the adaptor ROM at E000h completed. Passing control to the adaptor ROM at E000h next.
A9h	Returned from adaptor ROM at E000h control. Performing any initialization required after the E000 option ROM had control next.
AAh	Initialization after E000 option ROM control has completed. Displaying the system configuration next.
ABh	Building the multiprocessor table, if necessary.
ACh	Uncompressing the DMI data and initializing DMI POST next.
B0h	The system configuration is displayed.
B1h	Copying any code to specific areas.
00h	Code copying to specific areas is done. Passing control to INT 19h boot loader next.

The system BIOS passes control to different BUSes at the following checkpoints:

Checkpoint Code	Description
2Ah	Initializing the different bus system, static, and output devices, if present.
38h	Initialized bus input, IPL, and general devices, if present.
39h	Displaying bus initialization error messages, if any.
95h	Initializing bus adaptor ROMs from C8000h through D8000h.

SYSTEM

Additional BUS Checkpoints

While control is in the BUS routines, additional checkpoints are output to I/O port address 0080h as word to identify the routines being executed. These are word checkpoints. The low byte of checkpoint is the system BIOS checkpoint where control is passed to the different BUS routines. The high byte of checkpoint indicates that the routine is being executed in different BUSES.

The high byte of these checkpoints includes the following information:

Bits	Description
Bits 7-4	
0000	Function 0. Disable all devices on the bus.
0001	Function 1. Initialize static devices on the bus.
0010	Function 2. Initialize output devices on the bus.
0011	Function 3. Initialize input devices on the bus.
0100	Function 4. Initialize IPL devices on the bus.
0101	Function 5. Initiate general devices on the bus.
0110	Function 6. Initialize error reporting on the bus.
0111	Function 7. Initialize add-on ROMs for all buses.
Bits 3-0	Specify the bus
0	Generic DIM Device Initialization Manager.
1	Onboard System devices.
2	ISA devices.
3	EISA devices.
4	ISA PnP devices.
5	PCI devices.

Beep Codes

Fatal errors, which halt the boot process, are communicated through a series of audible beeps. If AMIBIOS POST can initialize the system video display, it displays the error message. Displayed error messages, in most cases, allow the system to continue to boot. Displayed error messages are described on pages 68-69. See the top of the next page for the beep code chart.

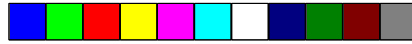

Beeps	Error Message	Description
1	Refresh Failure	The memory refresh circuitry is faulty.
2	Parity Error	Parity error in the base memory (the first 64 KB block) of memory.
3	Base 64 KB Memory Failure	Memory failure in first 64 KB.
4	Timer Not Operational	A memory failure in the first 64 KB of memory, or Timer 1 is not functioning.
5	Processor Error	The CPU generated an error.
6	8042 - Gate A20 Failure	Cannot switch to protected mode.
7	Processor Exception Interrupt Error	The CPU on the CPU Card generated an exception interrupt.
8	Display Memory Read/Write Error	The system video adapter is either missing or its memory is faulty. This is not a fatal error.
9	ROM Checksum Error	The ROM checksum value does not match the value encoded in AMIBIOS.
10	CMOS Shutdown Register Read/Write Error	The shutdown register for CMOS RAM has failed.
11	Cache Memory Bad — Do Not Enable Cache	The cache memory test failed. Cache memory is disabled. Do not press <Ctrl> <Alt> <Shift> <+> to enable cache memory.

Troubleshooting System Problems

If the computer beeps...

1, 2, or 3 times...

6 times...

8 times...

9 times...

11 times...

4, 5, 7, or 10 times...

then...

reseat the memory SIMMs or DIPs. If the system still beeps, replace the memory.

reseat the keyboard controller chip. If it still beeps, replace the keyboard controller. If it still beeps, try a different keyboard, or replace the keyboard fuse, if there is one.

there is a memory error on the video adapter. Replace the video adapter, or the RAM on the video adapter.

the BIOS ROM chip is bad. The system probably needs a new BIOS ROM chip.

reseat the cache memory on the motherboard. If it still beeps, replace the cache memory.

the motherboard must be replaced.

SYSTEM

Displayed Error Messages

If an error occurs after the system display has been initialized, the error message will be displayed as follows:

```
ERROR Message Line 1
ERROR Message Line 2
Press <F1> to continue
```

and the system halts. The system does not halt if Wait for <F1> If Any Error in Advanced Setup is Disabled.

RUN SETUP UTILITY

may also appear. Press <F1> to run WINBIOS Setup if this message appears.

Error Message	Explanation
8042 Gate-A20 Error	Gate A20 on the keyboard controller (8042) is not working. Replace the 8042.
Address Line Short!	Error in the address decoding circuitry.
C: Drive Error	No response from drive C:. Run the AMIDiag Hard Disk Utility. Check the C: hard disk type in Standard Setup.
C: Drive Failure	No response from hard disk drive C:. Replace the drive.
Cache Memory Bad, Do Not Enable Cache!	Cache memory is defective. Run AMIDiag.
CH-2 Timer Error	An AT system has two timers. There is an error in timer 2.
CMOS Battery State Low	CMOS RAM is powered by a battery. The battery power is low. Replace the battery.
CMOS Checksum Failure	CMOS RAM checksum is different than the previous value. Run WINBIOS Setup.
CMOS System Options Not Set	The values stored in CMOS RAM have been destroyed. Run WINBIOS Setup.
CMOS Display Type Mismatch	The video type in CMOS RAM does not match the type detected. Run WINBIOS Setup.
CMOS Memory Size Mismatch	The amount of memory found by AMIBIOS is different than the amount in CMOS RAM. Run WINBIOS Setup.
CMOS Time and Date Not Set	Run Standard Setup to set the date and time.
D: Drive Error	No response from drive D:. Run the AMIDiag Hard Disk Utility. Check the hard disk type in Standard Setup.

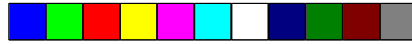

Error Message	Explanation
D: drive failure	No response from hard disk drive D:. Replace the drive.
Diskette Boot Failure	The boot diskette in drive A: cannot be used to boot the system. Use another boot diskette and follow the screen instructions.
Display Switch Not Proper	Some systems require a video switch be set to either color or monochrome. Turn the system off, set the switch properly, then power on.
DMA Error	Error in the DMA controller.
DMA 1 Error	Error in the first DMA channel.
DMA 2 Error	Error in the second DMA channel.
FDD Controller Failure	AMIBIOS cannot communicate with the floppy disk drive controller. Check all appropriate connections after the system is powered down.
HDD Controller Failure	AMIBIOS cannot communicate with the hard disk drive controller. Check all appropriate connections after the system is powered down.
INTR1 Error	Interrupt channel 1 failed POST.
INTR2 Error	Interrupt channel 2 failed POST.
Invalid Boot Diskette	AMIBIOS can read the diskette in floppy drive A:, but it cannot boot the system with it. Use another boot diskette and follow the screen instructions.
Keyboard Is Locked...Unlock It	The keyboard lock on the system is engaged. The system must be unlocked to continue to boot.
Keyboard Error	The keyboard has a timing problem. Make sure a Keyboard Controller AMIBIOS is installed. Set Keyboard in Advanced Setup to Not Installed to skip the keyboard POST routines.
KB/Interface Error	There is an error in the keyboard connector.
No ROM BASIC	Cannot find a proper bootable sector on either drive A: or C:. AMIBIOS cannot find ROM Basic.
Off Board Parity Error	Parity error in memory installed on an adapter card in an expansion slot. The format is: OFF BOARD PARITY ERROR ADDR = (XXXX) XXXX is the hex address where the error occurred. Run AMIDdiag to find and correct memory problems.
On Board Parity Error	Parity error in motherboard memory. The format is: ON BOARD PARITY ERROR ADDR = (XXXX) XXXX is the hex address where the error occurred. Run AMIDdiag to find and correct memory problems.
Parity Error ????	Parity error in system memory at an unknown address. Run AMIDdiag to find and correct memory problems.

SYSTEM

Additional Manuals

Your motherboard package also contains the following three User's Guides, in the Appendices section:

- A) Yamaha OPL3/OPL4 User's Guide
- B) Adaptec SCSI 7800 Family Manager Set User's Guide
- C) Adaptec AHA-3940AU/3940AUW User's Guide

Note that the Adaptec AHA-3940AU/3940AUW User's Guide contains instructions on installing the SCSI host adapter. As you have purchased a TYAN motherboard with the SCSI chip onboard, you do not need to worry about installing the host adapter. Skip these sections.



Attention: You cannot install the SCSI driver for Windows NT 4.0 if you boot up directly from the CDROM. You must install Windows NT 4.0 from the three diskettes provided by Microsoft.